

---

---

## maXTouch 640-node Touchscreen Controller

---

---

### maXTouch® Adaptive Sensing Technology

- Up to 32 X (transmit) lines and 20 Y (receive) lines for use by a touchscreen and/or key array
- A maximum of 640 nodes can be allocated to the touch sensor
- Touchscreen size of 9.66 inches (16:10 aspect ratio), assuming a sensor electrode pitch of 6.5 mm. Other sizes are possible with different electrode pitches and appropriate sensor material
- Multiple touch support with up to 16 concurrent touches tracked in real time

### Keys

- Up to 32 nodes can be allocated as mutual capacitance sensor keys in addition to the touchscreen, defined as 1 key array (subject to availability of X and Y lines and other configurations)
- Support for up to 3 mutual capacitance Generic Keys in addition to the touchscreen key array (subject to other configurations)
- Adjacent Key Suppression (AKS) technology is supported for false key touch prevention

### Touch Sensor Technology

- Discrete/out-cell support including glass and PET film-based sensors
- On-cell/touch-on display support including TFT, LCD (ITPS, IPS) and OLED
- Synchronization with display refresh timing capability
- Support for standard (for example, Diamond) and proprietary sensor patterns (review of designs by Microchip or a Microchip-qualified touch sensor module partner is recommended)

### Front Panel Material and Design

- Works with PET or glass, including curved profiles (configuration and stack-up to be approved by Microchip or a Microchip-qualified touch sensor module partner)
- 10 mm glass (or 5 mm PMMA) with bare finger (dependent on sensor size, touch size, configuration and stack-up)
- 6 mm glass (or 3 mm PMMA) with multi-finger 5 mm glove (2.7 mm PMMA equivalent) (dependent on sensor size, touch size, configuration and stack-up)
- Support for non-rectangular sensor designs (for example, circular, rounded or with cutouts)

### Touch Performance

- Moisture/Water Compensation
  - No false touch with condensation or water drop up to 22 mm diameter
  - One-finger tracking with condensation or water drop up to 22 mm diameter
- Mutual capacitance and self capacitance measurements supported for robust touch detection
- P2P mutual capacitance measurements supported for extra sensitive multi-touch sensing
- Noise suppression technology to combat ambient, charger, and power-line noise
  - Up to 240 V<sub>PP</sub> between 1 Hz and 1 kHz sinusoidal waveform
  - Up to 20 V<sub>PP</sub> between 1 kHz and 1 MHz sinusoidal waveform
- Stylus Support
  - Supports passive stylus with 1.5 mm contact diameter, subject to configuration, stack-up, and sensor design
- Burst Frequency
  - Flexible and dynamic Tx burst frequency selection to reduce EMC disturbance
  - Configurable Tx waveform shaping to reduce emissions
- Scan Speed
  - Typical report rate for 10 touches  $\geq 100$  Hz (subject to configuration)
  - Initial touch latency  $< 20$  ms for first touch from idle (subject to configuration)
  - Configurable to allow for power and speed optimization
- Touch panel failure detection
  - Automatic touch sensor diagnostics during run time to support the implementation of safety critical features
  - Diagnostics reported using dedicated output pin or by standard Object Protocol messages
  - Configurable test limits

### On-chip Gestures

- Reports one-touch and two-touch gestures

# mXT640UD-CCU001 1.0

---

## Enhanced Algorithms

- Lens bending algorithms to remove display noise
- Touch suppression algorithms to remove unintentional large touches, such as palm
- Palm Recovery Algorithm for quick restoration to normal state

## Data Store

- 32-byte CRC-checksummed data area for use as a run-time Product Data Store Area
- Up to 64 bytes of user's custom data (not CRC checksummed)

## Power Saving

- Programmable timeout for automatic transition from Active to Idle state
- Pipelined analog sensing detection and digital processing to optimize system power efficiency

## Application Interfaces

- Client interface for main communication with the device. Can be one of:
  - I<sup>2</sup>C interface, with support for Standard mode (up to 100 kHz), Fast mode (up to 400 kHz), Fast-mode Plus (up to 1 MHz), High Speed mode (up to 3.4 MHz)
  - HID-I<sup>2</sup>C interface for Microsoft Windows 8.x and later versions
- Interrupt to indicate when a message is available
- Additional Hardware Debug Interface to read the raw data for tuning and debugging purposes

## Power Supply

- Digital (Vdd) 3.3V nominal
- Digital I/O (VddIO) 3.3V nominal
- Analog (AVdd) 3.3V nominal
- High voltage internal X line drive (XVdd) 6.6V or 9.9V with internal voltage pump

## Package

- 88-ball UFBGA 6 × 6 × 0.6 mm, 0.5 mm pitch

## Operating Temperature

- -40°C to +85°C

## Design Services

- Review of device configuration, stack-up and sensor patterns
- Custom firmware versions can be considered
- Contact your Microchip representative for more information

PIN CONFIGURATION

88-ball UFBGA

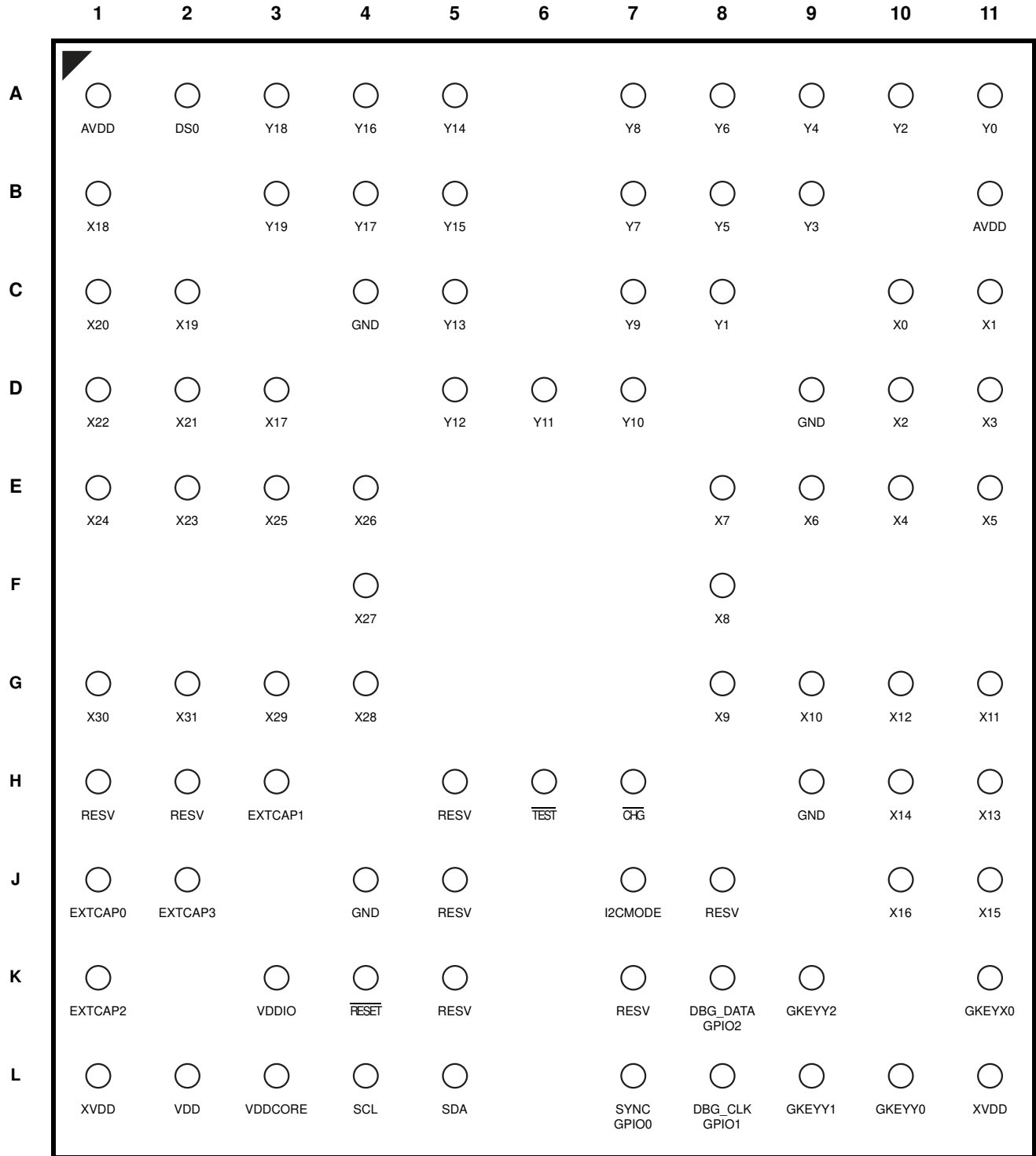

Top View

# mXT640UD-CCU001 1.0

**TABLE 1: PIN LISTING – 88-BALL UFBGA**

Ball	Name	Type	Supply	Comments	If Unused...
A1	AVDD	P	–	Analog power	–
A2	DS0	S	AVdd	Driven Shield signal; used as guard track between X/Y signals and ground	Leave open
A3	Y18	S	AVdd	Y line connection	Leave open
A4	Y16	S	AVdd	Y line connection	Leave open
A5	Y14	S	AVdd	Y line connection	Leave open
–					
A7	Y8	S	AVdd	Y line connection	Leave open
A8	Y6	S	AVdd	Y line connection	Leave open
A9	Y4	S	AVdd	Y line connection	Leave open
A10	Y2	S	AVdd	Y line connection	Leave open
A11	Y0	S	AVdd	Y line connection	Leave open
B1	X18	S	XVdd	X line connection	Leave open
–					
B3	Y19	S	AVdd	Y line connection	Leave open
B4	Y17	S	AVdd	Y line connection	Leave open
B5	Y15	S	AVdd	Y line connection	Leave open
–					
B7	Y7	S	AVdd	Y line connection	Leave open
B8	Y5	S	AVdd	Y line connection	Leave open
B9	Y3	S	AVdd	Y line connection	Leave open
–					
B11	AVDD	P	–	Analog power	–
C1	X20	S	XVdd	X line connection	Leave open
C2	X19	S	XVdd	X line connection	Leave open
–					
C4	GND	P	–	Ground	–
C5	Y13	S	AVdd	Y line connection	Leave open
–					
C7	Y9	S	AVdd	Y line connection	Leave open
C8	Y1	S	AVdd	Y line connection	Leave open
–					
C10	X0	S	XVdd	X line connection	Leave open
C11	X1	S	XVdd	X line connection	Leave open
D1	X22	S	XVdd	X line connection	Leave open
D2	X21	S	XVdd	X line connection	Leave open
D3	X17	S	XVdd	X line connection	Leave open
–					
D5	Y12	S	AVdd	Y line connection	Leave open
D6	Y11	S	AVdd	Y line connection	Leave open
–					
D7	Y10	S	AVdd	Y line connection	Leave open

**TABLE 1: PIN LISTING – 88-BALL UFBGA (CONTINUED)**

Ball	Name	Type	Supply	Comments	If Unused...
–					
D9	GND	P	–	Ground	–
D10	X2	S	XVdd	X line connection	Leave open
D11	X3	S	XVdd	X line connection	Leave open
E1	X24	S	XVdd	X line connection	Leave open
E2	X23	S	XVdd	X line connection	Leave open
E3	X25	S	XVdd	X line connection	Leave open
E4	X26	S	XVdd	X line connection	Leave open
–					
E8	X7	S	XVdd	X line connection	Leave open
E9	X6	S	XVdd	X line connection	Leave open
E10	X4	S	XVdd	X line connection	Leave open
E11	X5	S	XVdd	X line connection	Leave open
–					
F4	X27	S	XVdd	X line connection	Leave open
F8	X8	S	XVdd	X line connection	Leave open
G1	X30	S	XVdd	X line connection	Leave open
G2	X31	S	XVdd	X line connection	Leave open
G3	X29	S	XVdd	X line connection	Leave open
G4	X28	S	XVdd	X line connection	Leave open
–					
G8	X9	S	XVdd	X line connection	Leave open
G9	X10	S	XVdd	X line connection	Leave open
G10	X12	S	XVdd	X line connection	Leave open
G11	X11	S	XVdd	X line connection	Leave open
H1	RESV	S	–	Reserved for future use	Leave open
H2	RESV	S	–	Reserved for future use	Leave open
H3	EXTCAP1	P	–	Connect to EXTCAP2 via capacitor; see <a href="#">Section 2.2 “Schematic Notes”</a>	–
–					
H5	RESV	I	VddIO	Reserved for future use	Leave open
H6	$\overline{\text{TEST}}$	–	VddIO	Reserved for factory use. Pull up to VDDIO	–
–					
H7	$\overline{\text{CHG}}$	OD	VddIO	State change interrupt. Pull up to VddIO	Pull up to VddIO
–					
H9	GND	P	–	Ground	–
H10	X14	S	XVdd	X line connection	Leave open
H11	X13	S	XVdd	X line connection	Leave open
J1	EXTCAP0	P	–	Connect to EXTCAP3 via capacitor; see <a href="#">Section 2.2 “Schematic Notes”</a>	Leave open
J2	EXTCAP3	P	–	Connect to EXTCAP0 via capacitor; see <a href="#">Section 2.2 “Schematic Notes”</a>	Leave open
–					



---

---

**TABLE OF CONTENTS**

Pin configuration ..... 3

Table of Contents ..... 7

To Our Valued Customers ..... 8

1.0 Overview of mXT640UD-CCU001 ..... 9

2.0 Schematics ..... 10

3.0 Touchscreen Basics ..... 13

4.0 Sensor Layout ..... 14

5.0 Power-up / Reset Requirements ..... 17

6.0 Detailed Operation ..... 20

7.0 Host Communications ..... 24

8.0 I2C Communications ..... 25

9.0 HID-I<sup>2</sup>C Communications ..... 32

10.0 PCB Design Considerations ..... 41

11.0 Getting Started with mXT640UD-CCU001 ..... 46

12.0 Debugging and Tuning ..... 51

13.0 Specifications ..... 52

14.0 Packaging Information ..... 62

Appendix A. Associated Documents ..... 66

Appendix B. Revision History ..... 67

Index ..... 68

Product Identification System ..... 70

The Microchip Web Site ..... 71

The maXTouch web site ..... 71

Customer Change Notification Service ..... 71

Customer Support ..... 71

## TO OUR VALUED CUSTOMERS

It is our intention to provide our valued customers with the best documentation possible to ensure successful use of your Microchip products. To this end, we will continue to improve our publications to better suit your needs. Our publications will be refined and enhanced as new volumes and updates are introduced.

If you have any questions or comments regarding this publication, please contact the Marketing Communications Department via E-mail at [docerrors@microchip.com](mailto:docerrors@microchip.com). We welcome your feedback.

### Most Current Data Sheet

To obtain the most up-to-date version of this data sheet, please register at our Worldwide Web site at:

<http://www.microchip.com>

You can determine the version of a data sheet by examining its literature number found on the bottom outside corner of any page. The last character of the literature number is the version number, (for example, DS30000000A is version A of document DS30000000).

### Errata

An errata sheet, describing minor operational differences from the data sheet and recommended workarounds, may exist for current devices. As device/documentation issues become known to us, we will publish an errata sheet. The errata will specify the revision of silicon and revision of document to which it applies.

To determine if an errata sheet exists for a particular device, please check with one of the following:

- Microchip's Worldwide Web site; <http://www.microchip.com>
- Your local Microchip sales office (see last page)

When contacting Microchip, please specify which device, revision of silicon and data sheet (include literature number) you are using.

### Customer Notification System

Register on our web site at <http://www.microchip.com> to receive the most current information on all of our products.



## 1.0 OVERVIEW OF MXT640UD-CCU001

The Microchip maXTouch family of touch controllers brings industry-leading capacitive touch performance to customer applications. The mXT640UD-CCU001 features the latest generation of Microchip adaptive sensing technology that utilizes a hybrid mutual and self capacitive sensing system in order to deliver unparalleled touch features and a robust user experience.

- **Patented capacitive sensing method** – The mXT640UD-CCU001 uses a unique charge-transfer acquisition engine to implement Microchip’s patented capacitive sensing method. Coupled with a state-of-the-art CPU, the entire touchscreen sensing solution can measure, classify and track a number of individual finger touches with a high degree of accuracy in the shortest response time.
- **Capacitive Touch Engine (CTE)** – The mXT640UD-CCU001 features an acquisition engine that uses an optimal measurement approach to ensure almost complete immunity from parasitic capacitance on the receiver input lines. The engine includes sufficient dynamic range to cope with anticipated touchscreen self and mutual capacitances, which allows great flexibility for use with the Microchip proprietary sensor pattern designs. One- and two-layer ITO sensors are possible using glass or PET substrates.
- **Touch detection** – The mXT640UD-CCU001 allows for both mutual and self capacitance measurements, with the self capacitance measurements being used to augment the mutual capacitance measurements to produce reliable touch information.

When self capacitance measurements are enabled, touch classification is achieved using both mutual and self capacitance touch data. This has the advantage that both types of measurement systems can work together to detect touches under a wide variety of circumstances.

The system may be configured for different types of default measurements in both idle and active modes. For example, the device may be configured for Mutual Capacitance Touch as the default in active mode and Self Capacitance Touch as the default in idle mode. Note that other types of scans (such as P2P mutual capacitance scans and other types of self capacitance scans) may also be made depending on configuration.

Mutual capacitance touch data is used wherever possible to classify touches as this has a greater resolution than self capacitance measurements and provides positional information on touches. For this reason, multiple touches can only be determined by mutual capacitance touch data. In Self Capacitance Touch Default mode, if the self capacitance touch processing detects multiple touches, touchscreen processing is skipped until mutual capacitance touch data is available.

Self capacitance and P2P mutual capacitance measurements allow for the detection of touches in extreme scenarios, such as thick glove touches, when mutual capacitance touch detection alone may miss touches.

- **Display Noise Cancellation** – A combination of analog circuitry, hardware noise processing, and firmware combats display noise without requiring additional listening channels or synchronization to display timing. This enables the use of shieldless touch sensor stacks, including touch-on-lens.
- **Noise filtering** – Hardware noise processing in the capacitive touch engine provides enhanced autonomous filtering and allows a broad range of noise profiles to be handled. The result is good performance in the presence of LCD noise.
- **Processing power** – The main CPU has two companion microsequencer coprocessors under its control consuming low power. This system allows the signal acquisition, preprocessing and postprocessing to be partitioned in an efficient and flexible way.
- **Interpreting user intention** – The Microchip hybrid mutual and self capacitance method provides unambiguous multitouch performance. Algorithms in the mXT640UD-CCU001 provide optimized touchscreen position filtering for the smooth tracking of touches, responding to a user’s intended touches while preventing false touches triggered by ambient noise, conductive material on the sensor surface, such as moisture, or unintentional touches from the user’s resting palm or fingers.

# mXT640UD-CCU001 1.0

## 2.0 SCHEMATICS

### 2.1 88-ball UFBGA

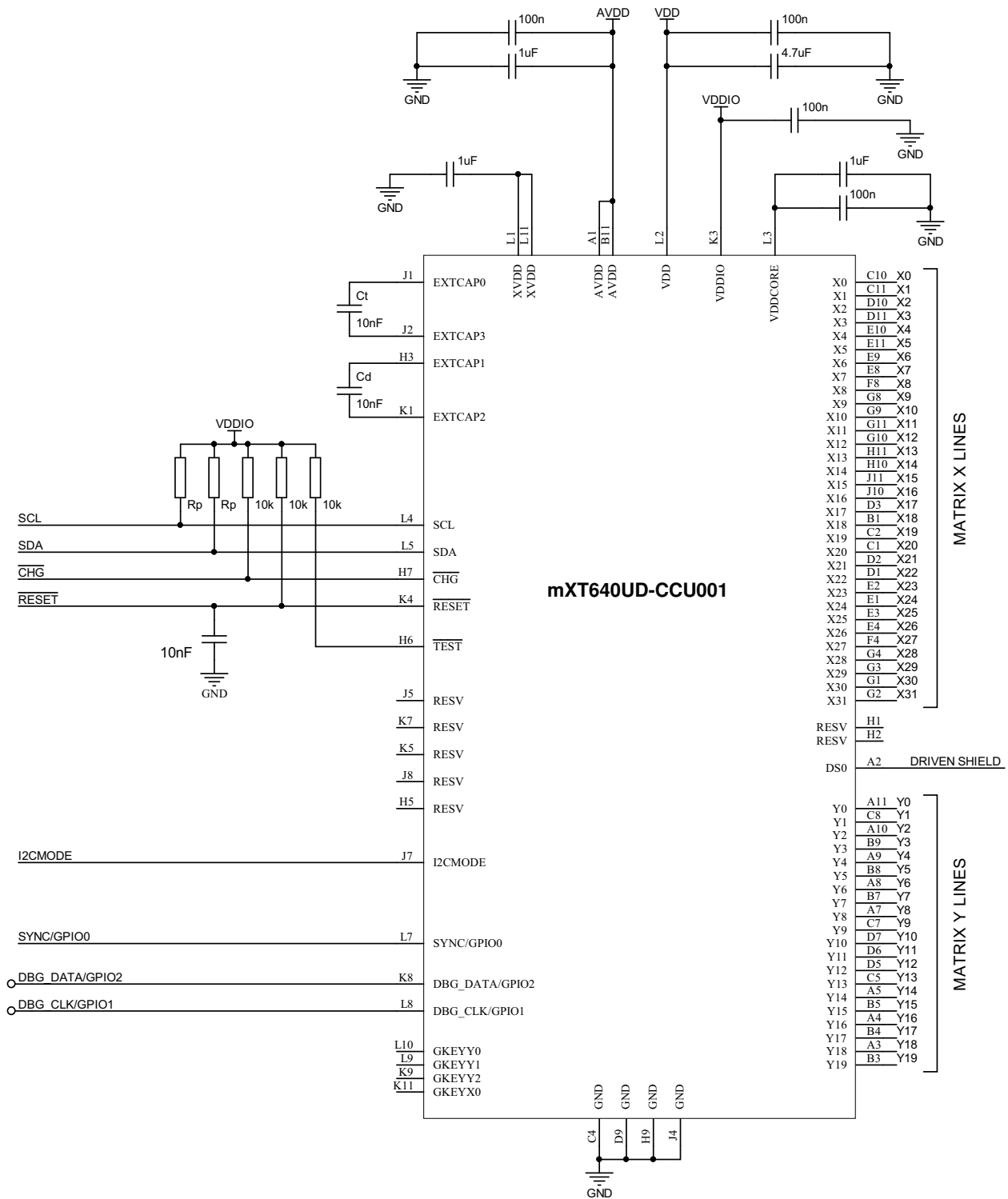

See [Section 2.2 "Schematic Notes"](#).

## 2.2 Schematic Notes

### 2.2.1 POWER SUPPLY

The sense and I/O pins are supplied by the different power rails on the device as listed in [“Pin configuration”](#).

### 2.2.2 DECOUPLING CAPACITORS

All decoupling capacitors must be X7R or X5R and placed less than 5 mm away from the pins for which they act as bypass capacitors. Pins of the same type can share a capacitor provided no pin is more than 10 mm from the capacitor.

The schematics on the previous pages show the capacitors required. The parallel combination of capacitors is recommended to give high and low frequency filtering, which is beneficial if the voltage regulators are likely to be some distance from the device (for example, if an active tail design is used). Note that this requires that the voltage regulator supplies for AVdd, Vdd and VddIO are clean and noise free. It also assumes that the track length between the capacitors and on-board power supplies is less than 50 mm.

The number of base capacitors can be reduced if the pinout configuration means that sharing a bypass capacitor is possible (subject to the distance between the pins satisfying the conditions above and there being no routing difficulties).

### 2.2.3 PULL-UP RESISTORS

The pull-up resistors shown in the schematics are suggested typical values and may be modified to meet the requirements of an individual customer design.

This applies, in particular, to the pull-up resistors on the I<sup>2</sup>C SDA and SCL lines (shown on the schematic), as the values of these resistors depend on the speed of the I<sup>2</sup>C interface. See [Section 13.9 “I2C Specification”](#) for details.

### 2.2.4 VDDCORE

VddCore is internally generated from the Vdd power supply. To guarantee stability of the internal voltage regulator, one or more external decoupling capacitors are required.

### 2.2.5 XVDD

XVdd power can be supplied either as high voltage (using an internal voltage tripler) or as low voltage (using an internal voltage doubler). The operating mode should be chosen according to the final application.

To operate in voltage tripler mode, the voltage pump requires two external capacitors:

- EXTCAP1 must be connected to EXTCAP2 via a capacitor (Cd).
- EXTCAP0 must be connected to EXTCAP3 via a capacitor (Ct).

To operate in voltage doubler mode, the voltage pump requires one external capacitor:

- EXTCAP1 must be connected to EXTCAP2 via a capacitor (Cd).
- EXTCAP0 and EXTCAP3 can be left unconnected.

Capacitors Cd and Ct should each provide a capacitance of 10 nF. The capacitors must be placed as close as possible to the EXTCAP $n$  pins.

### 2.2.6 DRIVEN SHIELD LINE

The driven shield line (DS0) should be used to shield the X/Y sense lines. Specifically, it acts as a driven shield in self capacitance operation. See [Section 10.4 “Driven Shield Line”](#) for more details.

### 2.2.7 MULTIPLE FUNCTION PINS

Some pins may have multiple functions. In this case, only one function can be chosen and the circuit should be designed accordingly.

### 2.2.8 SYNC PIN

The mXT640UD-CCU001 has a single SYNC pin that can be used for either frame synchronization (typically connected to VSYNC) or pulse synchronization (typically connected to HSYNC), but not both.

## 2.2.9 GPIO PINS

The mXT640UD-CCU001 has 3 GPIO pins. The pins can be set to be either an input or an output, as required, using the GPIO Configuration T19 object.

If a GPIO pin is unused, it can be left unconnected externally as long as it is given a defined state by the GPIO Configuration T19 object.

By default the GPIO pins are set to be inputs so if a pin is not used, and is left configured as an input, it should be connected to GND through a resistor. Alternatively, the internal pull-up resistor should be enabled (in the GPIO Configuration T19 object) to pull up the pin. Note that this does not apply if the GPIO pin is shared with a debug line; see [Section 2.2.10 “Hardware Debug Interface”](#) for advice on how to treat an unused GPIO pin in this case.

Alternatively, the GPIO pin can be set as an output low using the GPIO Configuration T19 object and left open. This second option avoids any problems should the pin accidentally be configured as output high at a later date.

If the GPIO Configuration T19 object is not enabled for use, the GPIO pins cannot be used for GPIO purposes, although any alternative function can still be used.

Some GPIO pins have alternative functions. If an alternative function is used then this takes precedence over the GPIO function and the pin cannot be used as a GPIO pin. In particular:

- GPIO0 cannot be used if the SYNC function is in use.
- The Hardware Debug Interface functionality is shared with some of the GPIO pins. See [Section 2.2.10 “Hardware Debug Interface”](#) for more details on the Hardware Debug Interface and how to handle these pins if they are totally unused.

## 2.2.10 HARDWARE DEBUG INTERFACE

The DBG\_CLK and DBG\_DATA lines form the Hardware Debug Interface. These pins should be routed to test points on all designs, such that they can be connected to external hardware during system development and for debug purposes. See also [Section 12.1 “Hardware Debug Interface”](#).

The debug lines may share pins with other functionality. If the circuit is designed to use the Hardware Debug Interface, then any alternative functionality cannot be used. Specifically:

- The DBG\_CLK line shares functionality with GPIO1; therefore GPIO1 cannot be used if the Hardware Debug Interface is in use.
- The DBG\_DATA line shares functionality with GPIO2; therefore GPIO2 cannot be used if the Hardware Debug Interface is in use.

The DBG\_CLK and DBG\_DATA lines should not be connected to power or GND. For this reason, where these pins are shared with GPIO pins and they are totally unused (that is, they are not being used as debug or GPIO pins), they should be set as outputs using the GPIO Configuration T19 object.

## 3.0 TOUCHSCREEN BASICS

### 3.1 Sensor Construction

A touchscreen is usually constructed from a number of transparent electrodes. These are typically on a glass or plastic substrate. They can also be made using non-transparent electrodes, such as copper or carbon. Electrodes are constructed from Indium Tin Oxide (ITO) or metal mesh. Thicker electrodes yield lower levels of resistance (perhaps tens to hundreds of  $\Omega$ /square) at the expense of reduced optical clarity. Lower levels of resistance are generally more compatible with capacitive sensing. Thinner electrodes lead to higher levels of resistance (perhaps hundreds of  $\Omega$ /square) with some of the best optical characteristics.

Interconnecting tracks in ITO can cause problems. The excessive RC time constants formed between the resistance of the track and the capacitance of the electrode to ground can inhibit the capacitive sensing function. In such cases, the tracks should be replaced by screen printed conductive inks (non-transparent) outside the touchscreen viewing area.

### 3.2 Electrode Configuration

The specific electrode designs used in Microchip touchscreens are the subject of various patents and patent applications. Further information is available on request.

The device supports various configurations of electrodes as summarized in [Section 4.0 "Sensor Layout"](#).

### 3.3 Scanning Sequence

All nodes are scanned in sequence by the device. Where possible, there is a parallelism in the scanning sequence to improve overall response time. The nodes are scanned by measuring capacitive changes at the intersections formed between the first drive (X) line and all the receive (Y) lines. Then the intersections between the next drive line and all the receive lines are scanned, and so on, until all X and Y combinations have been measured.

The device can be configured in various ways. It is possible to disable some nodes so that they are not scanned at all. This can be used to improve overall scanning time.

### 3.4 Touchscreen Sensitivity

#### 3.4.1 ADJUSTMENT

Sensitivity of touchscreens can vary across the extents of the electrode pattern due to natural differences in the parasitic capacitance of the interconnections, control chip, and so on. An important factor in the uniformity of sensitivity is the electrode design itself. It is a natural consequence of a touchscreen pattern that the edges form a discontinuity and hence tend to have a different sensitivity. The electrodes at the edges do not have a neighboring electrode on one side and this affects the electric field distribution in that region.

A sensitivity adjustment is available for the whole touchscreen. This adjustment is a basic algorithmic threshold that defines when a node is considered to have enough signal change to qualify as being in detect.

#### 3.4.2 MECHANICAL STACKUP

The mechanical stackup refers to the arrangement of material layers that exist above and below a touchscreen. The arrangement of the touchscreen in relation to other parts of the mechanical stackup has an effect on the overall sensitivity of the screen. The maXTouch technology has an excellent ability to operate in the presence of ground planes close to the sensor. The sensitivity of the maXTouch technology is attributed more to the interaction of the electric fields between the transmitting (X) and receiving (Y) electrodes than to the surface area of these electrodes. For this reason, stray capacitance on the X or Y electrodes does not strongly reduce sensitivity.

Front panel dielectric material has a direct bearing on sensitivity. Plastic front panels are usually suitable up to about 5 mm, and glass up to about 10 mm (dependent upon the screen size and layout). The thicker the front panel, the lower the signal-to-noise ratio of the measured capacitive changes and hence the lower the resolution of the touchscreen. In general, glass front panels are near optimal because they conduct electric fields almost twice as easily as plastic panels.

<b>NOTE</b> Care should be taken using ultra-thin glass panels as retransmission effects can occur, which can significantly degrade performance.
--

## 4.0 SENSOR LAYOUT

**NOTE** The specific electrode designs used in Microchip touchscreens may be the subject of various patents and patent applications. Further information is available on request.

### 4.1 Electrodes

The device supports various configurations of touch electrodes as summarized below:

- Touchscreen: 1 touchscreen panel occupies a rectangular matrix of up to 32 X × 20 Y lines maximum (subject to other configurations).
- Standard Keys: Up to 32 keys in an X/Y grid (Key Array), with each node (X/Y intersection) forming a key within the array.
- Generic Keys: Up to 3 keys in an X/Y grid (Key Array), implemented using the Generic Key lines.

Note that the 3 nodes provided by the Generic Key lines are in addition to the maximum 640 nodes permitted on the device. The physical sensor matrix is configured using one or more touch objects. It is not mandatory to have all the allowable touch objects on the device enabled, nor is it mandatory to use all the rows and columns on the matrix, so objects that are not required can be left disabled (default).

### 4.2 Sensor Matrix Layout

An example layout is shown in [Figure 4-1](#).

**FIGURE 4-1: EXAMPLE LAYOUT – TOUCHSCREEN WITH STANDARD KEY ARRAY**

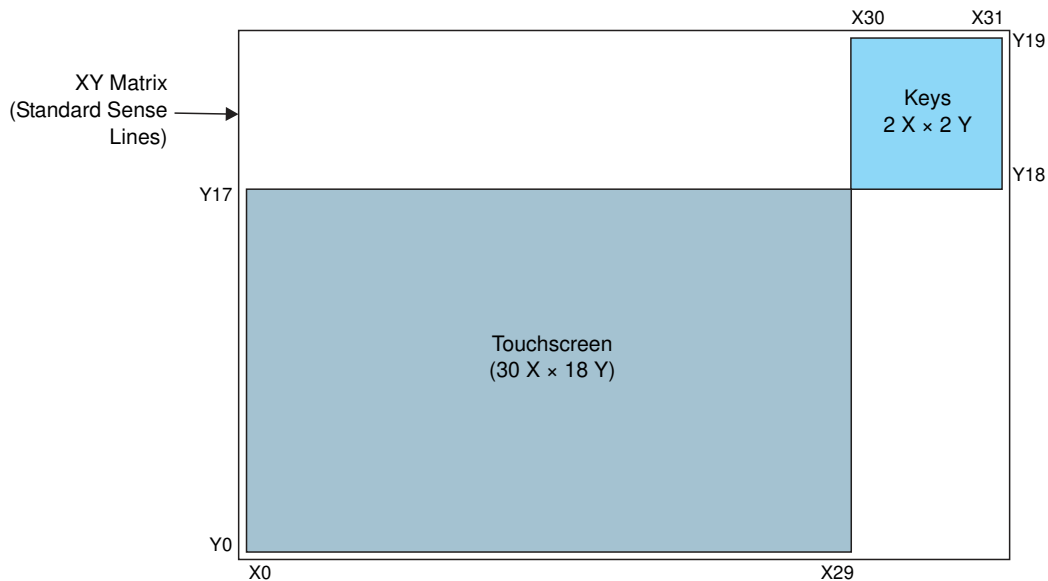
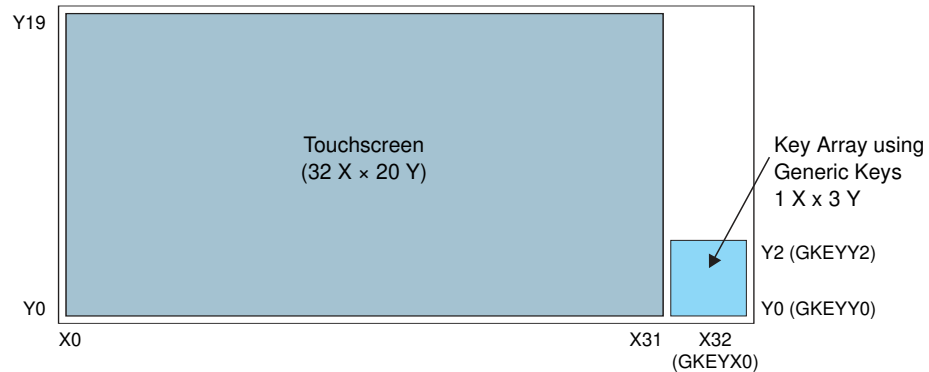

FIGURE 4-2: EXAMPLE LAYOUT – TOUCHSCREEN WITH GENERIC KEYS



**Note:** Generic Key X line (GKEYX0) is logically situated at X32 and Generic Key Y lines (GKEYY0 to GKEYY2) are logically situated at Y0 to Y2.

When designing the physical layout of the touch panel, the following rules must be obeyed:

• **General layout rules:**

- Each touch object should be a regular rectangular shape in terms of the lines it uses.
- Although each touch object must use a contiguous block of X or Y lines, there can be gaps between the blocks of X and Y lines used for the different touch objects

• **Additional layout rules for Multiple Touch Touchscreen T100:**

- The Multiple Touch Touchscreen T100 object **must** start at (X0, Y0)
- The Multiple Touch Touchscreen T100 object cannot share an X or Y line with another touch object (for example, a Key Array T15) if self capacitance measurements are enabled. Note that sharing of X or Y lines is allowed for mutual capacitance only designs, but this is not recommended for compatibility reasons.
- The touchscreen must contain a minimum of 3 X lines for mutual capacitance measurements. If Dual X Drive is enabled for use in the Noise Suppression T72 object, the minimum is 4 X lines.
- If self capacitance measurements are enabled in the Acquisition Configuration T8 object, the touchscreen must contain a minimum of 6 X lines.
- The touchscreen must contain a minimum of 3 Y lines.

• **Additional layout rules for Key Array T15:**

- The standard Key Array must occupy higher X and Y lines than those used by the Multiple Touch Touchscreen T100 object.
- Keys implemented as Generic Keys are in addition to the sensor matrix, and are therefore not affected by the allocation of the sensor X and Y lines.

### 4.3 Touchscreen Size

Table 4-1 lists some typical screen size and electrode pitch combinations to achieve various touchscreen aspect ratios.

TABLE 4-1: TYPICAL SCREEN SIZES

Aspect Ratio	Matrix Size	Node Count	Screen Diagonal (Inches)			
			4.5 mm Pitch <sup>(2)</sup>	5 mm Pitch	5.5 mm Pitch	6.5 mm Pitch
<b>Single Touchscreen <sup>(1)</sup></b>						
16:10	X = 32, Y = 20	640	6.69	7.43	8.17	9.66
16:9	X = 32, Y = 18	576	6.5	7.23	7.95	9.4
4:3	X = 27, Y = 20	540	5.95	6.61	7.28	8.6

**Note 1:** The figures given in the table are for a Touchscreen and show the largest node count possible to achieve the desired aspect ratio. No provision has been made for a Key Array.

**2:** Recommended sensor pitch for 1.5 mm passive stylus tip diameter.

## 4.4 Generic Key Array

The Generic Key lines can be used to form 3 mutual capacitance nodes that can be used to form a Key Array only.

Using the Generic Keys may add extra noise line measurements, which will impact power consumption and timings. It is therefore recommended that, where spare mutual capacitance sense lines are available, the sense lines are used to form a standard Key Array in preference to using the Generic Key lines.

### 4.4.1 DRIVEN SHIELD LINE

The driven shield line (DS0) should be used to shield the X/Y sense lines. See [Section 10.4 “Driven Shield Line”](#) for more details.



## 5.0 POWER-UP / RESET REQUIREMENTS

### 5.1 Power-on Reset

There is an internal Power-on Reset (POR) in the device.

If an external reset is to be used the device must be held in  $\overline{\text{RESET}}$  (active low) while the digital (Vdd), analog (AVdd) and digital I/O (VddIO) power supplies are powering up. The supplies must have reached their nominal values before the  $\overline{\text{RESET}}$  signal is deasserted (that is, goes high). This is shown in Figure 5-1. See Section 13.2 “Recommended Operating Conditions” for nominal values for the power supplies to the device.

**FIGURE 5-1: POWER SEQUENCING ON THE MXT640UD-CCU001**

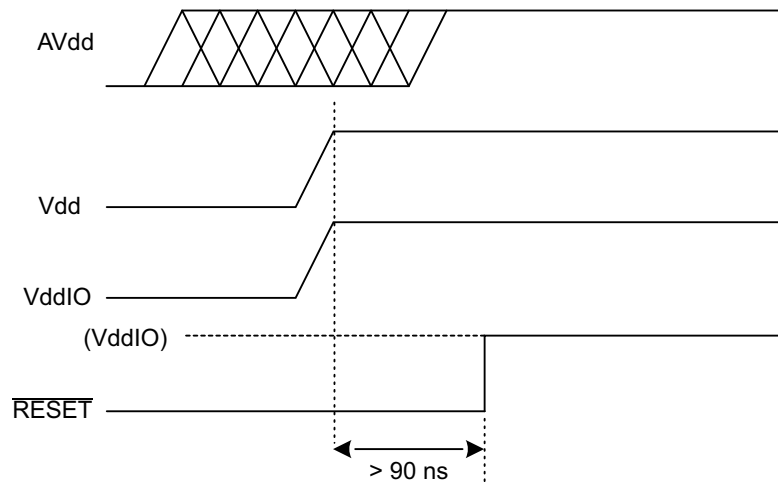

Note: When using external  $\overline{\text{RESET}}$  at power-up, VddIO must not be enabled after Vdd

It is recommended that customer designs include the capability for the host to control all the maXTouch power supplies and pull the RESET line low.

After power-up, the device typically takes 135 ms to 430 ms before it is ready to start communications, depending on the configuration.

**NOTE** Device initialization will not complete until after all the power supplies are present. If any power supply is not present, internal initialization stalls and the device will not communicate with the host.

If the  $\overline{\text{RESET}}$  line is released before the AVdd supply has reached its nominal voltage (see Figure 5-2), then some additional operations need to be carried out by the host. There are two options open to the host controller:

- Start the part in Deep Sleep mode and then send the command sequence to set the cycle time to wake the part and allow it to run normally. Note that in this case a calibration command is also needed.
- Send a RESET command.

**FIGURE 5-2: POWER SEQUENCING ON THE MXT640UD-CCU001 – LATE RISE ON AVDD**

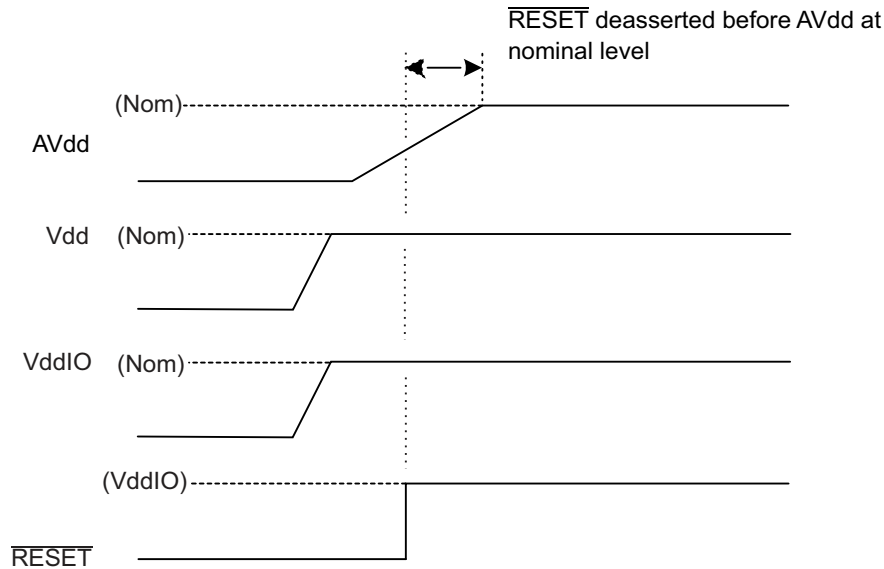

## 5.2 Hardware Reset

The  $\overline{\text{RESET}}$  pin can be used to reset the device whenever necessary. The  $\overline{\text{RESET}}$  pin must be asserted low for at least 90 ns to cause a reset. After the host has released the  $\overline{\text{RESET}}$  pin, the device typically takes 135 ms to 430 ms before it is ready to start communications, depending on the configuration. It is recommended to connect the  $\overline{\text{RESET}}$  pin to a host controller to allow the host to initiate a full hardware reset without requiring the mXT640UD-CCU001 to be powered down.

**WARNING** The device should be reset only by using the  $\overline{\text{RESET}}$  line. If an attempt is made to reset by removing the power from the device without also sending the signal lines low, power will be drawn from the communication and I/O lines and the device will not reset correctly.

Make sure that any lines connected to the device are below or equal to Vdd during power-up and power-down. For example, if  $\overline{\text{RESET}}$  is supplied from a different power domain to the VDDIO pin, make sure that it is held low when Vdd is off. If this is not done, the  $\overline{\text{RESET}}$  signal could parasitically couple power via the  $\overline{\text{RESET}}$  pin into the Vdd supply.

**NOTE** The voltage level on the  $\overline{\text{RESET}}$  pin of the device must never exceed VddIO (digital supply voltage).

A software RESET command (using the Command Processor T6 object) can be used to reset the chip. A software reset typically takes 155 ms to 460 ms before it is ready to start communications, depending on the configuration. After the chip has finished it asserts the CHG line to signal to the host that a message is available. The reset flag is set in the Command Processor T6 object message data to indicate to the host that it has just completed a reset cycle. This bit can be used by the host to detect any unexpected brownout events. This allows the host to take any necessary corrective actions, such as reconfiguration.

**NOTE** The CHG line is briefly set (~100 ms) as an input during power-up or reset. It is therefore particularly important that the line should be allowed to float high via the CHG line pull-up resistor during this period. It should never be driven by the host (see Section 13.5.3 "Reset Timings").

At power-on, the device can be configured to perform self tests (using the Self Test Control T10 object) to check for faults in the device.

### 5.3 Power-up and Reset Sequence – VddIO Enabled after Vdd

The power-up sequence that can be used in applications where VddIO must be powered up after Vdd, is shown in Figure 5-3.

In this case the communication interface to the maXTouch device is not driven by the host system. The  $\overline{\text{RESET}}$  and  $\overline{\text{CHG}}$  pins are connected to VddIO using suitable pull-up resistors. Vdd is powered up, followed by VddIO, no more than 10 ms after Vdd. Due to the pull-up resistors,  $\overline{\text{RESET}}$  and  $\overline{\text{CHG}}$  will rise with VddIO. The internal POR system ensures reliable boot up of the device and the  $\overline{\text{CHG}}$  line will go low approximately 135 ms to 430 ms (depending on the configuration) after Vdd to notify the host that the device is ready to start communication.

**FIGURE 5-3: POWER-UP SEQUENCE**

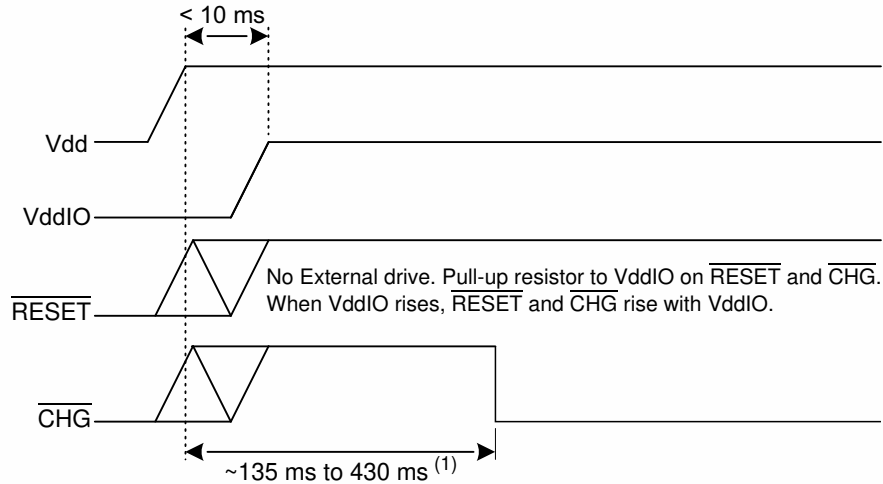

**Note 1:** Depends on configuration

## 6.0 DETAILED OPERATION

### 6.1 Touch Detection

The mXT640UD-CCU001 allows for both mutual and self capacitance measurements, with the self capacitance measurements being used to augment the mutual capacitance measurements to produce reliable touch information.

When self capacitance measurements are enabled, touch classification is achieved using both mutual and self capacitance touch data. This has the advantage that both types of measurement systems can work together to detect touches under a wide variety of circumstances.

Mutual capacitance touch data is used wherever possible to classify touches as this has greater granularity than self capacitance measurements and provides positional information on touches.

Self capacitance measurements, on the other hand, allow for the detection of single touches in extreme cases, such as single thick glove touches, when touches can only be detected by self capacitance data and may be missed by mutual capacitance touch detection.

### 6.2 Operational Modes

The device operates in two modes: **Active** (touch detected) and **Idle** (no touches detected). Both modes operate as a series of burst cycles. Each cycle consists of a short burst (during which measurements are taken) followed by an inactive sleep period. The difference between these modes is the length of the cycles. Those in idle mode typically have longer sleep periods. The cycle length is configured using the IDLEACQINT and ACTVACQINT settings in the Power Configuration T7. In addition, an *Active to Idle Timeout* setting is provided.

### 6.3 Detection Integrator

The device features a touch detection integration mechanism. This acts to confirm a detection in a robust fashion. A counter is incremented each time a touch has exceeded its threshold and has remained above the threshold for the current acquisition. When this counter reaches a preset limit the sensor is finally declared to be touched. If, on any acquisition, the signal is not seen to exceed the threshold level, the counter is cleared and the process has to start from the beginning.

The detection integrator is configured using the appropriate touch objects (Multiple Touch Touchscreen T100, Key Array T15).

### 6.4 Sensor Acquisition

The charge time for mutual capacitance measurements is set using the Acquisition Configuration T8 object. A number of factors influence the acquisition time for a single drive line and the total acquisition time for the sensor as a whole must not exceed 250 ms. If this condition is not met, a SIGERR will be reported.

Care should be taken to configure all the objects that can affect the measurement timing (for example, drift and noise measurement interval settings) so that these limits are not exceeded.

### 6.5 Calibration

Calibration is the process by which a sensor chip assesses the background capacitance on each node. Calibration occurs in a variety of circumstances, for example:

- When determined by the mutual capacitance recalibration process, as controlled by the Acquisition Configuration T8 object
- When determined by the self capacitance recalibration process, as controlled by the Self Capacitance Configuration T111 object
- When the Retransmission Compensation T80 object detects calibrated-in moisture has been removed
- Following a Self Capacitance Global Configuration T109 Tune command
- When the host issues a recalibrate command
- When certain configuration settings are changed

## 6.6 Digital Filtering and Noise Suppression

The mXT640UD-CCU001 supports on-chip filtering of the acquisition data received from the sensor. Specifically, the Noise Suppression T72 object provides an algorithm to suppress the effects of noise (for example, from a noisy charger plugged into the user's product). This algorithm can automatically adjust some of the acquisition parameters on-the-fly to filter the Analog-to-Digital Conversions (ADCs) received from the sensor.

Additional noise suppression is provided by the Self Capacitance Noise Suppression T108 object. Similar in both design and configuration to the Noise Suppression T72 object, the Self Capacitance Noise Suppression T108 object is the noise suppression interface for self capacitance touch measurements.

Noise suppression is triggered when a noise source is detected.

- The host driver code can indicate when a noise source is present.
- The noise suppression is also triggered based on the noise levels detected using internal line measurements. The Noise Suppression T72 and Self Capacitance Noise Suppression T108 object selects the appropriate controls to suppress the noise present in the system.

## 6.7 EMC Reduction

The mXT640UD-CCU001 has the following mechanisms to help reduce EMC emissions and ensure that the user's product operates within the desired EMC limits:

- **Spread Spectrum** – Varies the burst frequency on each measurement pulse to spread the EMC energy over the frequency domain. This feature is configured by the CTE Configuration T46 object.
- **Configurable Voltage Reference Mode** – Allows for the selection of voltage swing of the self capacitance measurements. This feature is configured by the Self Capacitance Global Configuration T109 object.
- **Input Buffer Power Configuration** – Controls the positive/negative drive strength of the Input Buffer for self capacitance measurements. This feature is configured by the Self Capacitance Global Configuration T109 object.
- **Configurable Input Amplifier Bias** – Controls the Input Amplifier Bias. This feature is configured by the Self Capacitance Global Configuration T109 object.
- **Configurable Wave Shaping** – Controls the voltage modulation on self capacitance scans allows wave shaping of the edge for EMC harmonic control. This feature is configured by the Self Capacitance Voltage Modulation T133 object.

## 6.8 Shieldless Support and Display Noise Suppression

The mXT640UD-CCU001 can support shieldless sensor design even with a noisy LCD.

The Optimal Integration feature is not filtering as such, but enables the user to use a shorter integration window. The integration window optimizes the amount of charge collected against the amount of noise collected, to ensure an optimal SNR. This feature also benefits the system in the presence of an external noise source. This feature is configured using the Shieldless T56 object.

Display noise suppression allows the device to overcome display noise simultaneously with external noise. This feature is based on filtering provided by the Lens Bending T65 object (see [Section 6.11 "Lens Bending"](#)).

## 6.9 Retransmission Compensation

The device can limit the undesirable effects on the mutual capacitance touch signals caused by poor device coupling to ground, such as poor sensitivity and touch break-up. This is achieved using the Retransmission Compensation T80 object. This object can be configured to allow the touchscreen to compensate for signal degradation due to these undesirable effects. If self capacitance measurements are also scheduled, the Retransmission Compensation T80 object will use the resultant data to enhance the compensation process.

The Retransmission Compensation T80 object is also capable of compensating for water presence on the sensor if self capacitance measurements are scheduled. In this case, both mutual capacitance and self capacitance measurements are used to detect moisture and then, once moisture is detected, self capacitance measurements are used to detect single touches in the presence of moisture.

## 6.10 Grip Suppression

The device has grip suppression functionality to suppress false detections from a user's grip.

Grip suppression works by specifying a boundary around a touchscreen, within which touches can be suppressed whilst still allowing touches in the center of the touchscreen. This ensures that an accidental hand touch on the edge is suppressed while still allowing a "real" (finger) touch towards the center of the screen. Mutual capacitance grip suppression is configured using the Grip Suppression T40 object.

Self Capacitance grip suppression works by looking for characteristic shapes in the self capacitance measurement along the touchscreen boundary, and thereby distinguishing between a grip and a touch further into the sensor. Self capacitance grip suppression is configured using the Self Capacitance Grip Suppression T112 object.

## 6.11 Lens Bending

The device supports algorithms to eliminate disturbances from the measured signal.

When the sensor suffers from the screen deformation (lens bending) the signal values acquired by normal procedure are corrupted by the disturbance component (bend). The amount of bend depends on:

- The mechanical and electrical characteristics of the sensor
- The amount and location of the force applied by the user touch to the sensor
- The Lens Bending T65 object measures the bend component and compensates for any distortion caused by the bend. As the bend component is primarily influenced by the user touch force, it can be used as a secondary source to identify the presence of a touch. The additional benefit of the Lens Bending T65 object is that it will eliminate LCD noise as well.

## 6.12 Glove Detection

The device has glove detection algorithms that process the measurement data received from the touchscreen classifying touches as potential gloved touches.

The Glove Detection T78 object is used to detect glove touches. In Normal Mode the Glove Detection T78 object applies vigorous glove classification to small signal touches to minimize the effect of unintentional hovering finger reporting. Once a gloved touch is found, the Glove Detection T78 object can enter Glove Confidence Mode. In this mode the device expects the user to be wearing gloves so the classification process is much less stringent.

## 6.13 Stylus Support

The mXT640UD-CCU001 allows for the particular characteristics of passive stylus touches, whilst still allowing conventional finger touches to be detected. The touch sensitivity and threshold controls for stylus touches are configured separately from those for conventional finger touches so that both types of touches can be accommodated.

Stylus support ensures that the small touch area of a stylus registers as a touch, as this would otherwise be considered too small for the touchscreen. Additionally, there are controls to distinguish a stylus touch from an unwanted approaching finger (such as on the hand holding the stylus).

Passive stylus touches are configured by the Passive Stylus T47 object. There is one instance of the Passive Stylus T47 object for each Multiple Touch Touchscreen T100 object present on the device.

## 6.14 Unintentional Touch Suppression

The Touch Suppression T42 object provides a mechanism to suppress false detections from unintentional touches from a large body area, such as from a face, ear or palm. The Touch Suppression T42 object also provides Maximum Touch Suppression to suppress all touches if more than a specified number of touches has been detected.

## 6.15 Adjacent Key Suppression Technology

Adjacent Key Suppression (AKS) technology is a patented method used to detect which touch object (Multiple Touch Touchscreen T100 or Key Array T15) is touched, and to suppress touches on the other touch objects, when touch objects are located close together.

The device has two levels of AKS:

- The first level works between the touch objects (Multiple Touch Touchscreen T100 and Key Array T15). The touch objects are assigned to AKS groups. If a touch occurs within one of the touch objects in a group, then touches within other objects inside that group are suppressed. For example, if a touchscreen and a Key Array are placed in the same AKS group, then a touch in the touchscreen will suppress touches in the Key Array, and vice versa. Objects can be in more than one AKS group.
- The second level of AKS is internal AKS within an individual Key Array object. If internal AKS is enabled, then when one key is touched, touches on all the other keys within the Key Array are suppressed. Note that internal AKS is not present on other types of touch objects.

<b>NOTE</b> AKS can be applied to a Key Array T15 instance that configures either a standard key array or a generic key array.
--

# mXT640UD-CCU001 1.0

---

## 7.0 HOST COMMUNICATIONS

Communication between the mXT640UD-CCU001 and the host is achieved using one of the following:

- I<sup>2</sup>C (see [Section 8.0 “I<sup>2</sup>C Communications”](#))
- HID-I<sup>2</sup>C (see [Section 9.0 “HID-I<sup>2</sup>C Communications”](#))

Either mode can be used, depending on the needs of the user’s project, but only one mode can be used in any one design.

### 7.1 I<sup>2</sup>C Mode Selection – I2CMODE Pin

The selection of the I<sup>2</sup>C or the HID-I<sup>2</sup>C mode is determined by connecting the I2CMODE pin according to [Table 7-1](#).

**TABLE 7-1: I<sup>2</sup>C MODE SELECTION**

I2CMODE	Interface Selected
Connected to GND	HID-I <sup>2</sup> C
Pulled up to VddIO <sup>(1)</sup>	I <sup>2</sup> C

**Note 1:** Requires an external pull-up resistor



## 8.0 I<sup>2</sup>C COMMUNICATIONS

Communication with the mXT640UD-CCU001 can be carried out over the I<sup>2</sup>C interface.

The I<sup>2</sup>C interface is used in conjunction with the  $\overline{\text{CHG}}$  line. The  $\overline{\text{CHG}}$  line going active signifies that a new data packet is available. This provides an interrupt-style interface and allows the device to present data packets when internal changes have occurred. See [Section 8.5 “CHG Line”](#) for more information.

See [Section 7.0 “Host Communications”](#) for information on selecting I<sup>2</sup>C mode.

### 8.1 I<sup>2</sup>C Address

The mXT640UD-CCU001 supports one fixed I<sup>2</sup>C device address: 0x4B.

The I<sup>2</sup>C address is shifted left to form the SLA+W or SLA+R address when transmitted over the I<sup>2</sup>C interface, as shown in [Table 8-1](#).

**TABLE 8-1: FORMAT OF SLA+W/SLA+R**

Bit 7	Bit 6	Bit 5	Bit 4	Bit 3	Bit 2	Bit 1	Bit 0
Address: 0x4B							Read/write

### 8.2 Writing To the Device

An I<sup>2</sup>C WRITE cycle consists of the following bytes:

START	1 bit	I <sup>2</sup> C START condition
SLA+W	1 byte	I <sup>2</sup> C address of the device (see <a href="#">Section 8.1 “I<sup>2</sup>C Address”</a> )
Address (LSByte, MSByte)	2 bytes	Address of the location at which the data writing starts. This address is stored as the address pointer.
Data	0 or more bytes	The actual data to be written. The data is written to the device, starting at the location of the address pointer. The address pointer returns to its starting value when the I <sup>2</sup> C STOP condition is detected.
CRC (optional)	1 byte	An optional 8-bit CRC that includes all the bytes that have been sent, including the two address bytes, but not the SLA+W byte. If the device detects an error in the CRC during a write transfer, a COMSERR fault is reported by the Command Processor T6 object.  See <a href="#">Section 8.3 “I<sup>2</sup>C Writes in Checksum Mode”</a> for more details
STOP	1 bit	I <sup>2</sup> C STOP condition

[Figure 8-1](#) shows an example of writing four bytes of data to contiguous addresses starting at 0x1234.

**FIGURE 8-1: EXAMPLE OF A FOUR-BYTE WRITE STARTING AT ADDRESS 0x1234**

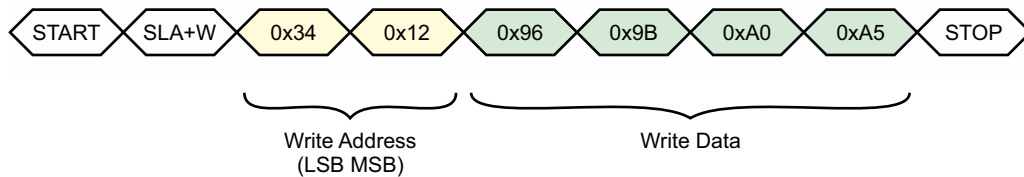

### 8.3 I<sup>2</sup>C Writes in Checksum Mode

In I<sup>2</sup>C checksum mode an 8-bit CRC is added to all I<sup>2</sup>C writes. The CRC is sent at the end of the data write as the last byte before the STOP condition. All the bytes sent are included in the CRC, including the two address bytes. Any command or data sent to the device is processed even if the CRC fails.

To indicate that a checksum is to be sent in the write, the most significant bit of the MSByte of the write address is set to 1. For example, the I<sup>2</sup>C command shown in [Figure 8-2](#) writes a value of 150 (0x96) to address 0x1234 with a checksum. The address is changed to 0x9234 to indicate checksum mode.

**FIGURE 8-2: EXAMPLE OF A WRITE TO ADDRESS 0x1234 WITH A CHECKSUM**

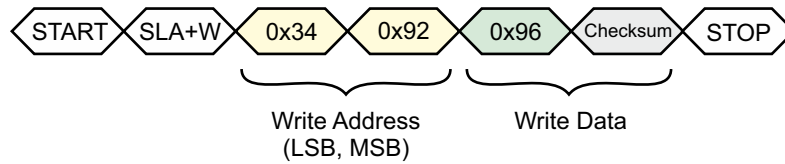

## 8.4 Reading From the Device

Two I<sup>2</sup>C bus activities must take place to read from the device. The first activity is an I<sup>2</sup>C write to set the address pointer (LSByte then MSByte). The second activity is the actual I<sup>2</sup>C read to receive the data. The address pointer returns to its starting value when the read cycle NACK or STOP is detected.

It is not necessary to set the address pointer before every read. The address pointer is updated automatically after every read operation. The address pointer will be correct if the reads occur in order. In particular, when reading multiple messages from the Message Processor T5 object, the address pointer is automatically reset to the address of the Message Processor T5 object, in order to allow continuous reads (see [Section 8.4.2 “Reading Status Messages with DMA”](#)).

The WRITE and READ cycles consist of a START condition followed by the I<sup>2</sup>C address of the device (SLA+W or SLA+R respectively).

Figure 8-3 shows the I<sup>2</sup>C commands to read four bytes starting at address 0x1234.

**FIGURE 8-3: EXAMPLE OF A FOUR-BYTE READ STARTING AT ADDRESS 0x1234**

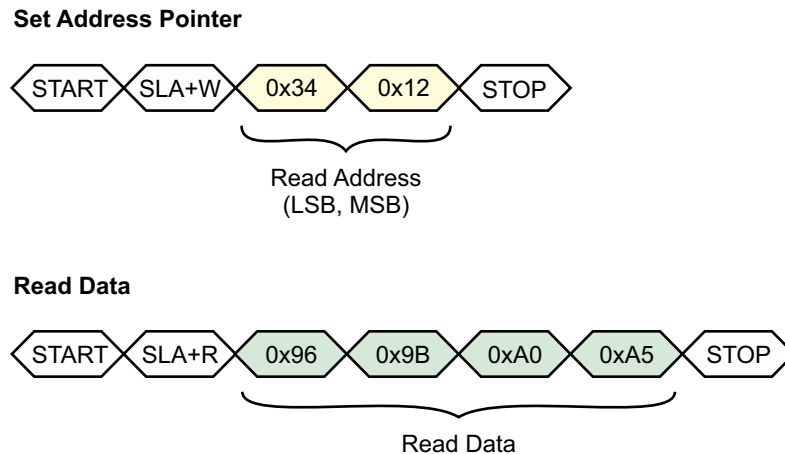

**NOTE** At least one data byte must be read during an I<sup>2</sup>C READ transaction; it is illegal to abort the transaction with an I<sup>2</sup>C STOP condition without reading any data.

8.4.1 READING A MESSAGE FROM THE MESSAGE PROCESSOR T5 OBJECT

An I<sup>2</sup>C read of the Message Processor T5 object contains the following bytes:

START	1 bit	I <sup>2</sup> C START condition
SLA+R	1 byte	I <sup>2</sup> C address of the device (see <a href="#">Section 8.1 "I2C Address"</a> )
Report ID	1 byte	Message report ID
Data	1 or more bytes	The message data (size = size of Message Processor T5 MESSAGE field)
CRC (optional)	1 byte	An 8-bit CRC (if requested) for the Message Processor T5 report ID and message data  See <a href="#">Section 8.3 "I<sup>2</sup>C Writes in Checksum Mode"</a> for more details on how to request a checksum
STOP	1 bit	I <sup>2</sup> C STOP condition

Figure 8-4 shows an example read from the Message Processor T5 object. To read multiple messages using Direct Memory Access, see [Section 8.4.2 "Reading Status Messages with DMA"](#).

**FIGURE 8-4: EXAMPLE READ FROM MESSAGE PROCESSOR T5 WITH A CHECKSUM**

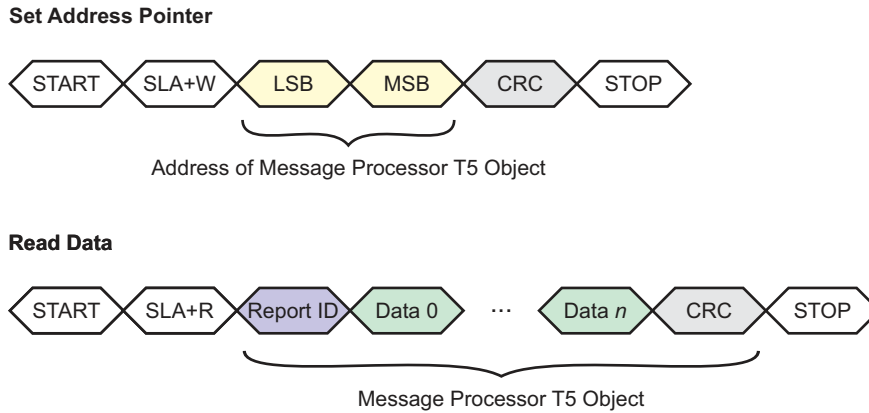

8.4.2 READING STATUS MESSAGES WITH DMA

The device facilitates the easy reading of multiple messages using a single continuous read operation. This allows the host hardware to use a Direct Memory Access (DMA) controller for the fast reading of messages, as follows:

1. The host uses a write operation to set the address pointer to the start of the Message Count T44 object, if necessary. Note that the STOP condition at the end of the read resets the address pointer to its initial location, so it may already be pointing at the Message Count T44 object following a previous message read. If a checksum is required on each message, the most significant bit of the MSByte of the read address must be set to 1.
2. The host starts the read operation of the message by sending a START condition.
3. The host reads the Message Count T44 object (one byte) to retrieve a count of the pending messages.
4. The host calculates the number of bytes to read by multiplying the message count by the size of the Message Processor T5 object. Note that the host should have already read the size of the Message Processor T5 object in its initialization code.

Note that the size of the Message Processor T5 object as recorded in the Object Table includes the checksum. If a checksum has not been requested, one byte should be deducted from the size of the object.

That is: number of bytes = count × (size – 1).

5. The host reads the calculated number of message bytes. It is important that the host does *not* send a STOP condition during the message reads, as this will terminate the continuous read operation and reset the address pointer. No START and STOP conditions must be sent between the messages.
6. The host sends a STOP condition at the end of the read operation after the last message has been read. The NACK condition immediately before the STOP condition resets the address pointer to the start of the Message Count T44 object.

Figure 8-5 shows an example of using a continuous read operation to read three messages from the device without a checksum. Figure 8-6 shows the same example with a checksum.

**FIGURE 8-5: CONTINUOUS MESSAGE READ EXAMPLE – NO CHECKSUM**

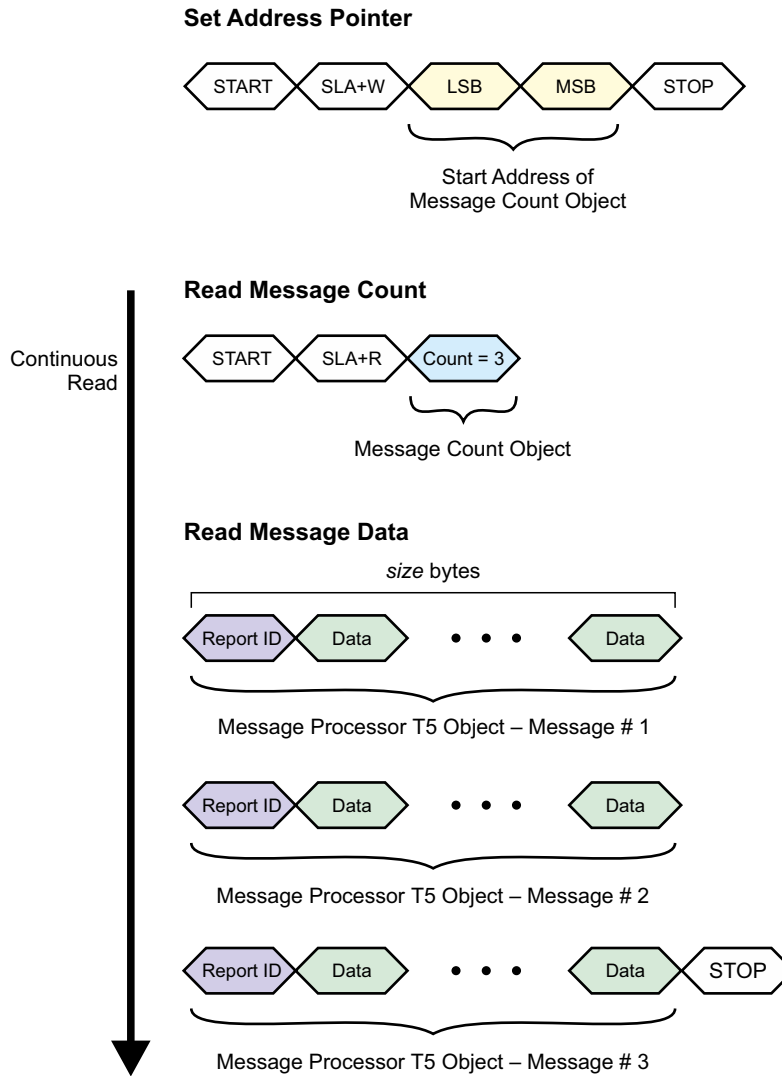
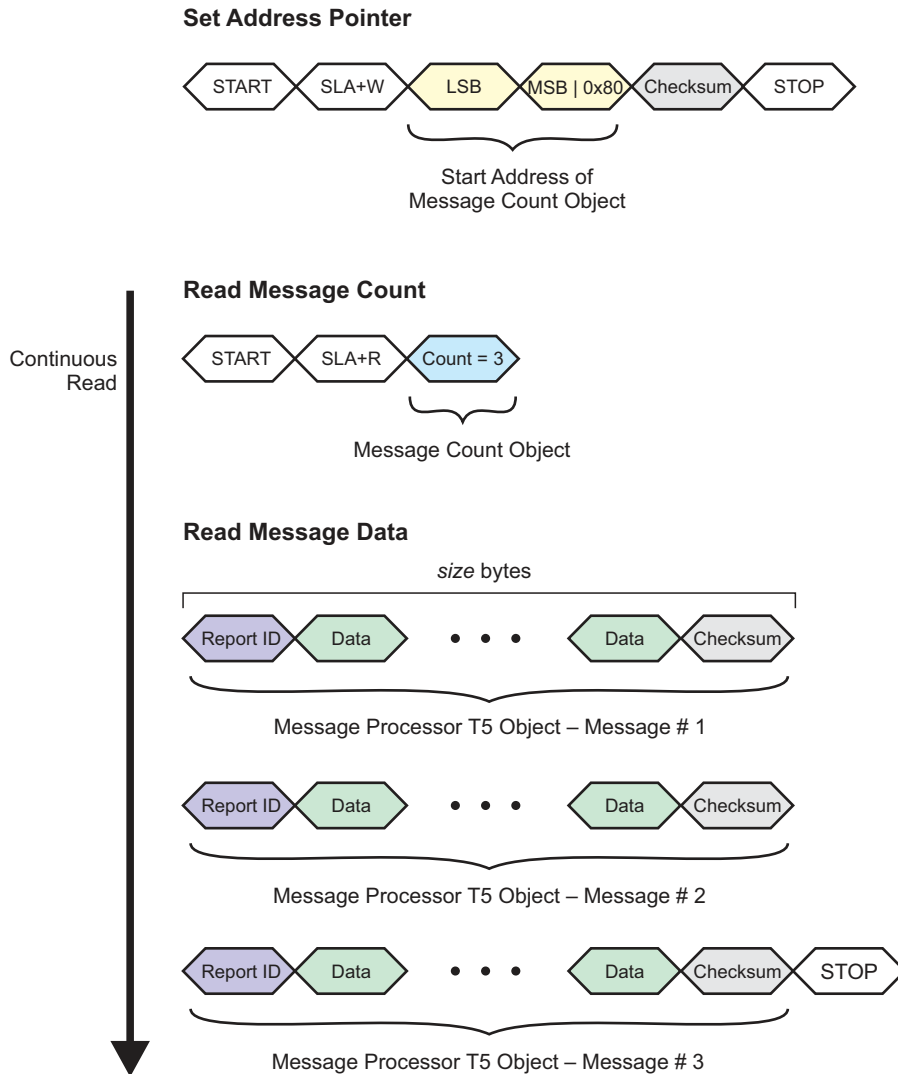

FIGURE 8-6: CONTINUOUS MESSAGE READ EXAMPLE – I<sup>2</sup>C CHECKSUM MODE



## 8.5 $\overline{\text{CHG}}$ Line

The  $\overline{\text{CHG}}$  line is an active-low, open-drain output that is used as an interrupt to alert the host that the client is ready to send a response or that an OBP message is pending and ready to be read from the host. This provides the host with an interrupt-style interface with the potential for fast response times. It reduces the need for wasteful I<sup>2</sup>C communications.

**NOTE** The host should always use the  $\overline{\text{CHG}}$  line as an indication that a message is ready to be read from the Message Processor T5 object; the host should never poll the device for messages.

The  $\overline{\text{CHG}}$  line should always be configured as an input on the host during normal usage. This is particularly important after power-up or reset (see [Section 5.0 "Power-up / Reset Requirements"](#)).

A pull-up resistor is required to VddIO (see [Section 2.0 "Schematics"](#)).

The  $\overline{\text{CHG}}$  line operates in two modes when it is used with I<sup>2</sup>C communications, as defined by the Communications Configuration T18 object.

**NOTE** If the HID-I<sup>2</sup>C interface is in use, for compliance with the HID-I<sup>2</sup>C Specification, level-triggered operation should be used for the  $\overline{\text{CHG}}$  line (that is, Mode 1).

**FIGURE 8-7:  $\overline{\text{CHG}}$  LINE MODES FOR I<sup>2</sup>C-COMPATIBLE TRANSFERS**

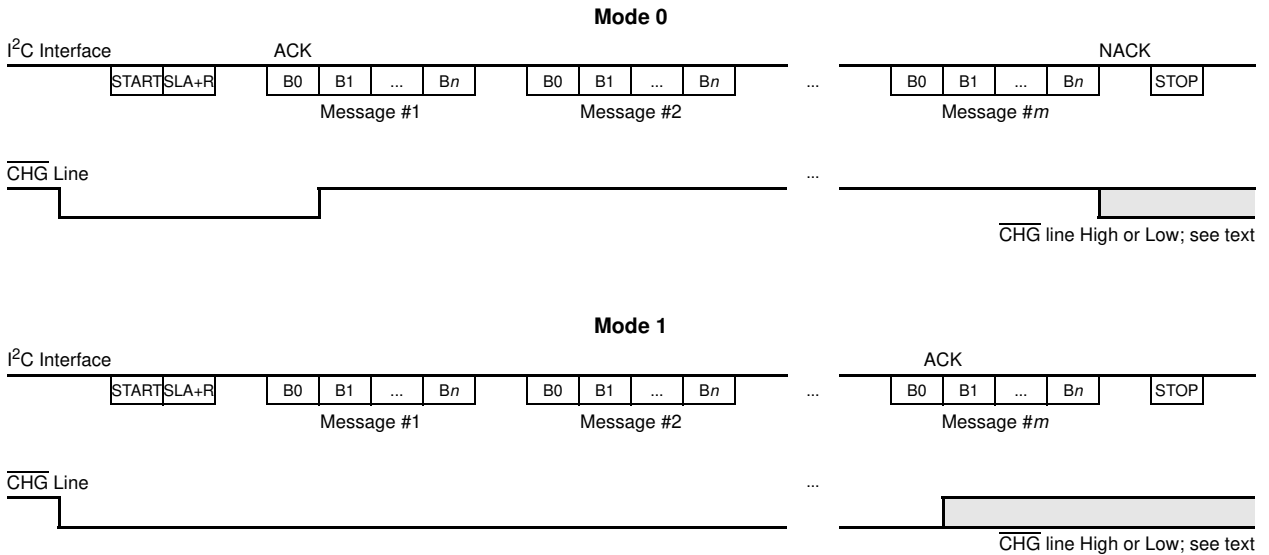

In Mode 0 (edge-triggered operation):

1. The  $\overline{\text{CHG}}$  line goes low to indicate that a message is present.
2. The  $\overline{\text{CHG}}$  line goes high when the first byte of the first message (that is, its report ID) has been sent and acknowledged (ACK sent) and the next byte has been prepared in the buffer.
3. The STOP condition at the end of an I<sup>2</sup>C transfer causes the  $\overline{\text{CHG}}$  line to stay high if there are no more messages. Otherwise the  $\overline{\text{CHG}}$  line goes low to indicate a further message.

Note that Mode 0 also allows the host to continually read messages by simply continuing to read bytes back without issuing a STOP condition. Message reading should end when a report ID of 255 (“invalid message”) is received. Alternatively the host ends the transfer by sending a NACK after receiving the last byte of a message, followed by a STOP condition. If there is another message present, the  $\overline{\text{CHG}}$  line goes low again, as in step 1. In this mode the state of the  $\overline{\text{CHG}}$  line does not need to be checked during the I<sup>2</sup>C read.

In Mode 1 (level-triggered operation):

1. The  $\overline{\text{CHG}}$  line goes low to indicate that a message is present.
2. The  $\overline{\text{CHG}}$  line remains low while there are further messages to be sent after the current message.
3. The  $\overline{\text{CHG}}$  line goes high again only once the first byte of the last message (that is, its report ID) has been sent and acknowledged (ACK sent) and the next byte has been prepared in the output buffer.

Mode 1 allows the host to continually read the messages until the  $\overline{\text{CHG}}$  line goes high, and the state of the  $\overline{\text{CHG}}$  line determines whether or not the host should continue receiving messages from the device.

**NOTE** The state of the  $\overline{\text{CHG}}$  line should be checked only between messages and not between the bytes of a message. The precise point at which the  $\overline{\text{CHG}}$  line changes state cannot be predicted and so the state of the  $\overline{\text{CHG}}$  line cannot be guaranteed between bytes.

The Communications Configuration T18 object can be used to configure the behavior of the  $\overline{\text{CHG}}$  line. In addition to the  $\overline{\text{CHG}}$  line operation modes described above, this object allows direct control over the state of the  $\overline{\text{CHG}}$  line.

## 8.6 SDA and SCL

The I<sup>2</sup>C bus transmits data and clock with SDA and SCL, respectively. These are open-drain. The device can only drive these lines low or leave them open. The termination resistors (Rp) pull the line up to VddIO if no I<sup>2</sup>C device is pulling it down.

The termination resistors should be chosen so that the rise times on SDA and SCL meet the I<sup>2</sup>C specifications for the interface speed being used, bearing in mind other loads on the bus. For best latency performance, it is recommended that no other devices share the I<sup>2</sup>C bus with the maXTouch controller.

## 8.7 Clock Stretching

The device supports clock stretching in accordance with the I<sup>2</sup>C specification. It may also instigate a clock stretch if a communications event happens during a period when the device is busy internally. The maximum clock stretch is 2 ms and typically less than 350  $\mu$ s.

## 9.0 HID-I<sup>2</sup>C COMMUNICATIONS

The device is an HID-I<sup>2</sup>C device presenting two Top-level Collections (TLCs):

- **Generic HID-I<sup>2</sup>C** – Provides a generic HID-I<sup>2</sup>C interface that allows the host to communicate with the device using the object-based protocol (OBP).
- **Digitizer HID-I<sup>2</sup>C** – Supplies touch information to the host. This interface is supported by Microsoft Windows without the need for additional software.

See [Section 7.0 “Host Communications”](#) for information on selecting HID-I<sup>2</sup>C mode.

Other features are identical to standard I<sup>2</sup>C communication described in [Section 8.0 “I<sup>2</sup>C Communications”](#).

Refer to the Microsoft HID-I<sup>2</sup>C documentation, *HID Over I<sup>2</sup>C Protocol Specification – Device Side*, for information on the HID-I<sup>2</sup>C specification.

## 9.1 I<sup>2</sup>C Addresses

See [Section 8.1 “I<sup>2</sup>C Address”](#).

## 9.2 Device Specification

The device is compliant with HID-I<sup>2</sup>C Specification V1.0. It has the specification shown in [Table 9-1](#).

**TABLE 9-1: DEVICE SPECIFICATION**

Parameter	Value
Vendor ID	0x03EB (Microchip)
Product ID	0x2195 (mXT640UD-CCU001)
Version ID	A 16-bit number representing the firmware version and build number
HID Descriptor Address	0x0000

## 9.3 HID Descriptor

The host should read the HID descriptor on initialization to ascertain the key attribute of the HID device. These include the report description and the report ID to be used for communication with the HID device. The HID descriptor address is 0x0000.

Note that the host driver must not make any assumptions about the report packet formats, data locations or report IDs. These must be read from the HID descriptor as they may change in future versions of the firmware.

For more information on how to read the HID descriptor, refer to the Microsoft HID-I<sup>2</sup>C documentation.

## 9.4 HID-I<sup>2</sup>C Report IDs

[Table 9-2](#) describes the HID-I<sup>2</sup>C report IDs used in reports sent to the host.

<b>NOTE</b>	The term HID-I <sup>2</sup> C report ID should not be confused with the term report ID as used in the Object Protocol; the two are entirely different concepts. Refer to the <i>mXT640UD-CCU001 1.0 Protocol Guide</i> for more information on the use of Object Protocol report IDs.
-------------	---

**TABLE 9-2: HID-I<sup>2</sup>C REPORT IDS**

Top-level Collection	Report ID	Description
Generic HID-I <sup>2</sup> C	0x06	Object Protocol (OBP) command and response (see <a href="#">Section 9.5 “Generic HID-I<sup>2</sup>C TLC”</a> )
Digitizer HID-I <sup>2</sup> C	0x01	Touch report (see <a href="#">Section 9.6.1 “Touch Report”</a> )
	0x02	Maximum Touches (Surface Contacts) report (see <a href="#">Section 9.6.3 “Maximum Touches Report”</a> )



## 9.5 Generic HID-I<sup>2</sup>C TLC

The Generic HID-I<sup>2</sup>C TLC supports an input report for receiving data from the device and an output report for sending data to the device.

Commands are sent by the host using the output reports. Responses from the device are sent using input reports.

The supported commands are listed in [Table 9-3](#).

**TABLE 9-3: GENERIC HID-I<sup>2</sup>C TLC COMMANDS**

Command ID	Command
0x51	Read/Write Memory Map
0x88	Send Auto-return Messages

The HID-I<sup>2</sup>C report ID used is that for Object Protocol commands and responses; see [Table 9-2](#) for the value.

### 9.5.1 READ/WRITE MEMORY MAP COMMAND

This command is used to carry out a write/read operation on the memory map of the device.

The data packet for a read/write command consists of 18 bytes, made up of a 1-byte HID-I<sup>2</sup>C report ID followed by 17 bytes of data (see [Figure 9-1](#)).

**FIGURE 9-1: READ/WRITE MEMORY MAP – GENERIC PACKET FORMAT**

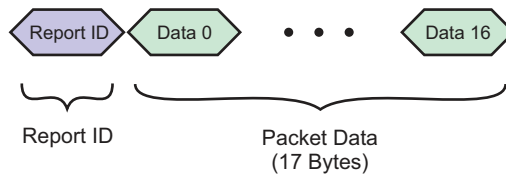

#### 9.5.1.1 Command and Response Packets

The command packet has the generic format given in [Figure 9-2](#). The following sections give examples on using the command to write to the memory map and to read from the memory map.

**FIGURE 9-2: READ/WRITE MEMORY MAP – COMMAND PACKET FORMAT**

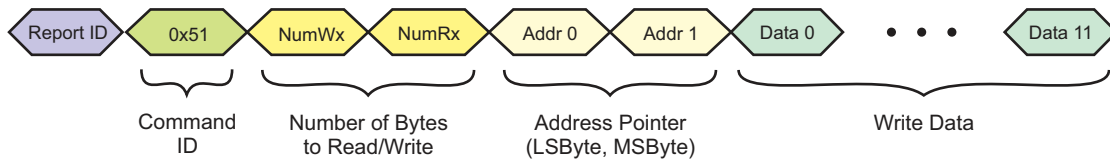

In [Figure 9-2](#):

- **Rpt ID** is the HID-I<sup>2</sup>C report ID used for Object Protocol commands and responses (see [Table 9-2](#)).
- **Command ID** is the command ID for the write/read operation (0x51)
- **NumWx** is the number of data bytes to write to the memory map (may be zero). If the address pointer is being sent, this must include the size of the address pointer.
- **NumRx** is the number of data bytes to read from the memory map (may be zero).
- **Addr 0** and **Addr 1** form the address pointer to the memory map (where necessary; may be zero if not needed). This is typically an address of an object within the device.
- **Data 0** to **Data 11** are the bytes of data to be written (in the case of a write). Note that data locations beyond the number specified by NumWx will be ignored.

The response packet has the generic format given in [Figure 9-3](#).

**FIGURE 9-3: READ/WRITE MEMORY MAP – RESPONSE PACKET FORMAT**

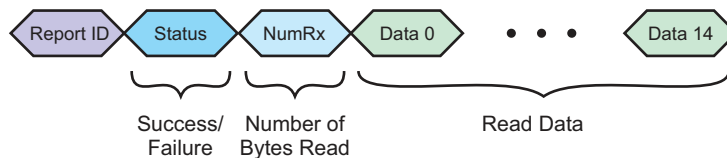

In [Figure 9-3](#):

- **Rpt ID** is the HID-I<sup>2</sup>C report ID used for Object Protocol commands and responses (see [Table 9-2 on page 32](#)).
- **Status** indicates the result of the command:
  - 0x00 = read and write completed; read data returned
  - 0x04 = write completed; no read data requested
- **NumRx** is the number of bytes following that have been read from the memory map (in the case of a read). This will be the same value as NumRx in the command packet.
- **Data 0 to Data 14** are the data bytes read from the memory map.

### 9.5.1.2 Writing To the Device

A write operation cycle to the device consists of sending a packet that contains six header bytes. These specify the HID-I<sup>2</sup>C report ID, the Command ID, the number of bytes to read, the number of bytes to write, and the 16-bit address pointer. Subsequent bytes in a multi-byte transfer form the actual data. These are written to the location of the address pointer, location of the address pointer +1, location of the address pointer + 2, and so on.

[Figure 9-4](#) shows an example command packet to write four bytes of data to contiguous addresses starting at 0x1234.

**FIGURE 9-4: EXAMPLE OF A FOUR-BYTE WRITE COMMAND STARTING AT ADDRESS 0x1234**

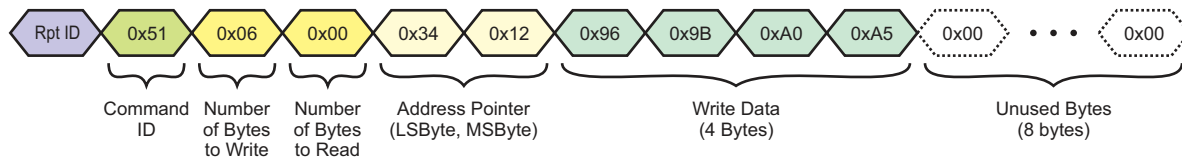

In [Figure 9-4](#):

- **Rpt ID** is the HID-I<sup>2</sup>C report ID used for Object Protocol commands and responses (see [Table 9-2 on page 32](#)).
- **Number of Bytes to Read** is set to zero as this is a write-only operation.
- **Number of Bytes to Write** is six (that is, four data bytes plus the two address pointer bytes).

[Figure 9-5](#) shows the response to this command. In this case, the result status returned is 0x04 (that is, the write operation was completed but no read data was requested). Note that the report ID will be the same one used in the command packet.

**FIGURE 9-5: RESPONSE TO EXAMPLE FOUR-BYTE WRITE**

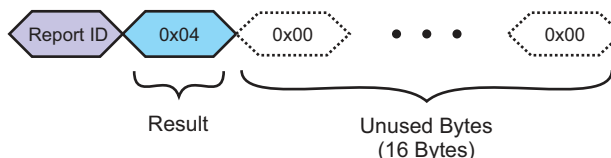

### 9.5.1.3 Reading From the Device

A read operation consists of sending a packet that contains the six header bytes only and no write data.

[Figure 9-6](#) shows an example command packet to read four bytes starting at address 0x1234. Note that the address pointer is included in the number of bytes to write, so the number of bytes to write is set to 2 as there are no other data bytes to be written.

**FIGURE 9-6: EXAMPLE OF A FOUR-BYTE READ COMMAND STARTING AT ADDRESS 0x1234**

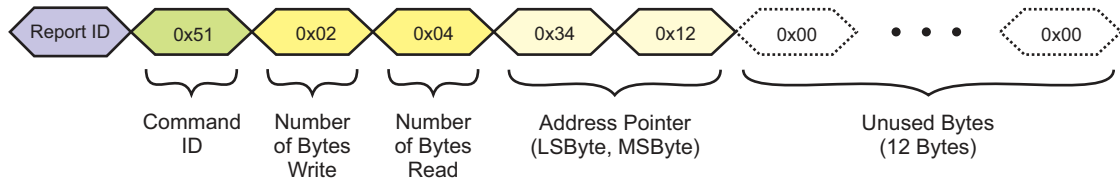

It is not necessary to set the address pointer before every read. The address pointer is updated automatically after every read operation, so the address pointer will be correct if the reads occur in order.

Figure 9-7 shows the response to this command. The result status returned is 0x00 (that is the write operation was completed and the data was returned). The number of bytes returned will be the same as the number requested (4 in this case).

**FIGURE 9-7: RESPONSE TO EXAMPLE FOUR-BYTE READ**

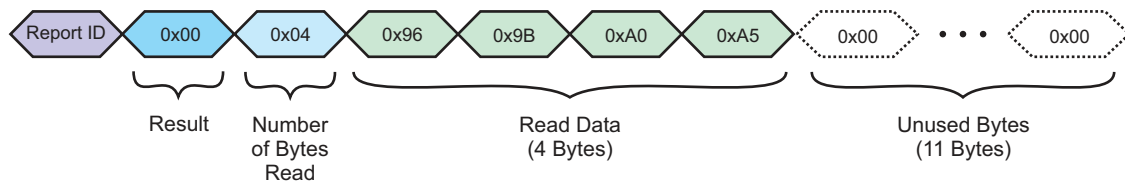

9.5.2 SEND AUTO-RETURN COMMAND

With this command the device can be configured to return new messages from the Message Processor T5 object autonomously.

The packet sequence to do this is shown in Figure 9-8.

**FIGURE 9-8: SEND AUTO-RETURN – PACKET SEQUENCE**

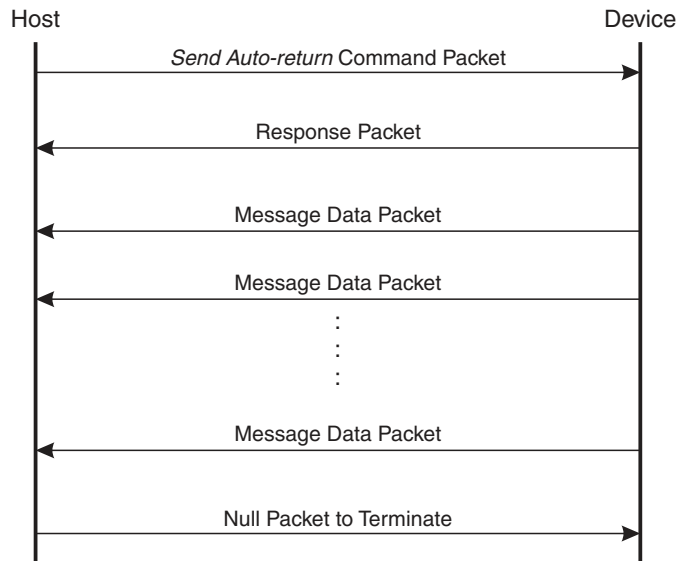

The data packet for Send Auto-return commands consists of 14 bytes, made up of a 1-byte HID-I<sup>2</sup>C report ID followed by 13 bytes of data. Note that this is different to the packet for standard read/write operations described in Section 9.5.1 “Read/Write Memory Map Command”.

The command packet has the format given in Figure 9-9.

**FIGURE 9-9: SEND AUTO-RETURN – COMMAND PACKET FORMAT**

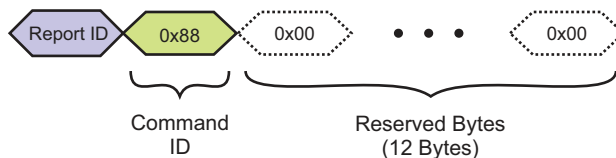

In [Figure 9-9](#):

- **Rpt ID** is the HID-I<sup>2</sup>C report ID used for Object Protocol commands and responses (see [Table 9-2 on page 32](#)).
- **Command ID** is the command ID for the Send Auto-return command (0x88)
- **Reserved Bytes** are reserved bytes with a value of 0x00.

Note that with this command, the command packet does not include an address pointer as the device already knows the address of the Message Processor T5 object.

The response packet has the format given in [Figure 9-10](#).

**FIGURE 9-10: SEND AUTO-RETURN – RESPONSE PACKET FORMAT**

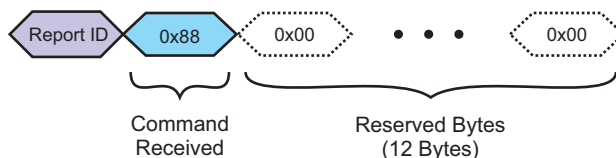

Once the device has responded to the command, it starts sending message data. Each time a message is generated in the Message Processor T5 object, the device automatically sends a message packet to the host with the data. The message packets have the format given in [Figure 9-11](#).

**FIGURE 9-11: SEND AUTO-RETURN – MESSAGE PACKET FORMAT**

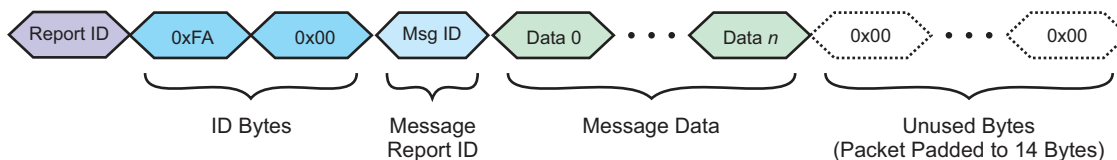

In [Figure 9-11](#):

- **Rpt ID** is the HID-I<sup>2</sup>C report ID used for Object Protocol commands and responses (see [Table 9-2 on page 32](#)).
- **ID Bytes** identify the packet as an auto-return message packet.
- **Message Report ID** is the report ID returned by the Message Processor T5 object. Note that this is the report ID used in the Object Protocol and should not be confused with the HID-I<sup>2</sup>C report ID. Refer to the *mXT640UD-CCU001 1.0 Protocol Guide* for more information on the use of Object Protocol report IDs.
- **Message Data** bytes are the bytes of data returned by the Message Processor T5 object. The size of the data depends on the source object for which this is the message data. Any unused bytes are padded with zeros. Refer to the *mXT640UD-CCU001 1.0 Protocol Guide* for more information on the messages from the various objects.

To stop the sending of the messages, the host can send a null command packet. This consists of two bytes: the HID-I<sup>2</sup>C report ID for Object Protocol commands and responses (see [Table 9-2 on page 32](#)) and a null command byte of 0x00 (see [Figure 9-12](#)).

**FIGURE 9-12: SEND AUTO-RETURN – NULL COMMAND PACKET FORMAT**

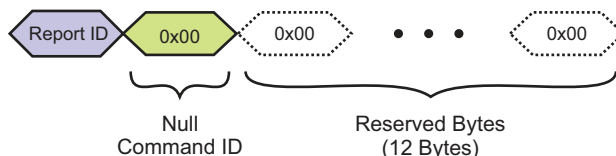

Note that any standard read or write operation will also terminate any currently enabled auto-return mode (see Section 9.5.1 "Read/Write Memory Map Command").

Figure 9-13 shows an example sequence of packets to receive messages from the Message Processor T5 object using the Send Auto-return command.

**FIGURE 9-13: SEND AUTO-RETURN – EXAMPLE SEQUENCE**

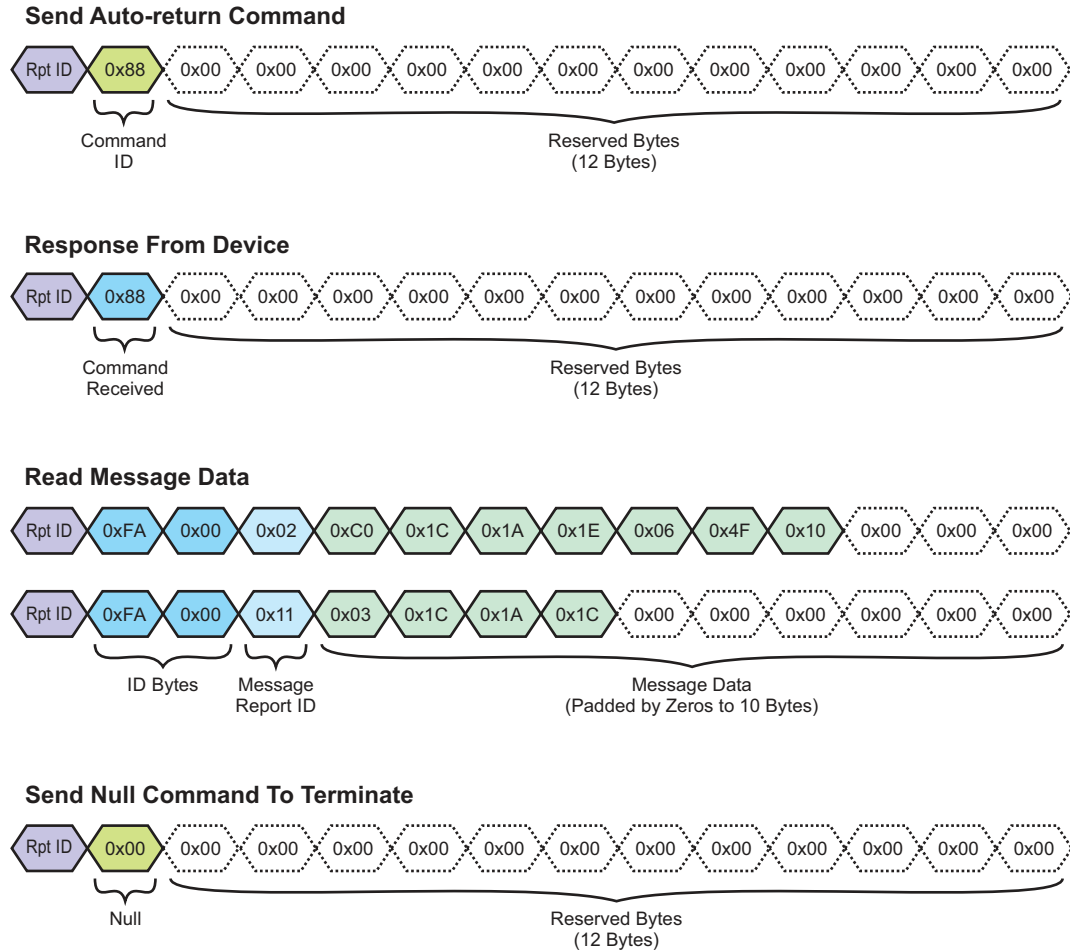

# mXT640UD-CCU001 1.0

## 9.6 Digitizer HID-I<sup>2</sup>C

This is a digitizer class HID.

### 9.6.1 TOUCH REPORT

The format of a Touch report is shown in [Figure 9.6.2](#). Each Touch report is 18 bytes long and contains the data for one touch.

### 9.6.2 TOUCH REPORT PACKET FORMAT

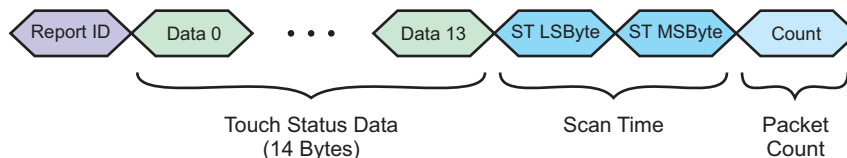

In [Figure 9.6.2](#):

- **Rpt ID** is the HID-I<sup>2</sup>C report ID used for Touch reports (see [Table 9-2 on page 32](#)).
- **Touch** is the data for the touch.
- **Scan Time** is the Timestamp for the report packet
- **Count** is used to identify the report packets for current active touches that are to be reported as a single package. The Count in the first packet for the first touch is set to the number of active touches to be sent in one package (that is, the number of packets). Subsequent packets for subsequent active touches have a Count of 0.

An example of the Touch report packets for 3 active touches is shown in [Figure 9-14](#).

**FIGURE 9-14: EXAMPLE TOUCH REPORT PACKETS FOR 3 ACTIVE TOUCHES**

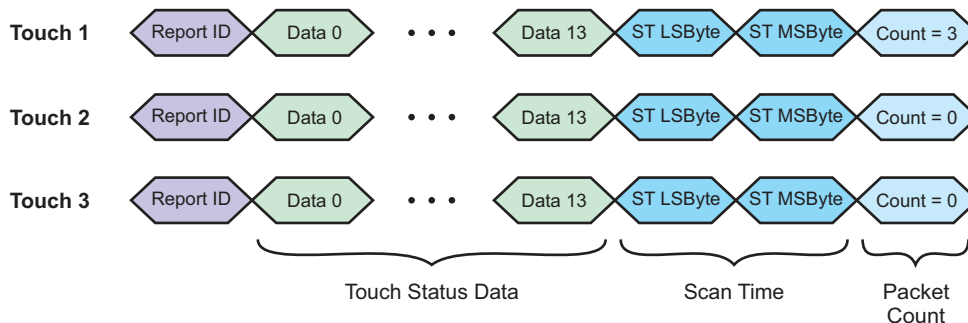

Each input report consists of a HID-I<sup>2</sup>C report ID followed by 17 bytes that describe the status of one active touch. The input report format depends on the geometry calculation control (TCHGEOMEN) of the Digitizer HID Configuration T43 object. [Table 9-4](#) and [Table 9-5](#) give the detailed format of a touch report packet.

**TABLE 9-4: TOUCH REPORT FORMAT WHEN TCHGEOMEN = 1**

Byte	Bit 7	Bit 6	Bit 5	Bit 4	Bit 3	Bit 2	Bit 1	Bit 0
0	HID-I <sup>2</sup> C Touch Report ID							
1	Reserved							Status
2	Touch ID							
3	Touch X Position LSByte (first touch)							
4	Reserved				Touch X Position MSBits (first touch)			
5	Touch Center X Position LSByte (first touch)							
6	Reserved				Touch Center X Position MSBits (first touch)			
7	Touch Y Position LSByte (first touch)							
8	Reserved				Touch Y Position MSBits (first touch)			
9	Touch Center Y Position LSByte (first touch)							
10	Reserved				Touch Center Y Position MSBits (first touch)			

**TABLE 9-4: TOUCH REPORT FORMAT WHEN TCHGEOMEN = 1 (CONTINUED)**

Byte	Bit 7	Bit 6	Bit 5	Bit 4	Bit 3	Bit 2	Bit 1	Bit 0
11	Touch Width							
12	Reserved							
13	Touch Height							
14	Reserved							
15	Scan Time LSByte							
16	Scan Time MSByte							
17	Packet Count							

**TABLE 9-5: TOUCH REPORT FORMAT WHEN TCHGEOMEN = 0**

Byte	Bit 7	Bit 6	Bit 5	Bit 4	Bit 3	Bit 2	Bit 1	Bit 0
0	HID-I <sup>2</sup> C Touch Report ID							
1	Reserved							Status
2	Touch ID							
3	Touch X Position LSByte (first touch)							
4	Reserved				Touch X Position MSBits (first touch)			
5	Reserved							
6	Reserved							
7	Touch Y Position LSByte (first touch)							
8	Reserved				Touch Y Position MSBits (first touch)			
9	Reserved							
10	Reserved							
11	Reserved							
12	Reserved							
13	Reserved							
14	Reserved							
15	Scan Time LSByte							
16	Scan Time MSByte							
17	Packet Count							

- **Byte 0:**  
The HID-I<sup>2</sup>C report ID (see [Table 9-2 on page 32](#) for Touch reports).
- **Byte 1:**  
**Status** is the status of the touch detection. This bit is set to 1 if touch is detected, and set to 0, if no touches are detected.
- **Byte 2:**  
**Touch ID** identifies the touch for which this is a status report (starting from 0).
- **Bytes 3 to 10:**  
**X and Y positions** identify the touch position. These are scaled to 12-bit resolution. This means that the upper four bits of the MSByte will always be zero. Bytes 5, 6, 9 and 10 are reserved when TCHGEOMEN field is set to 0.
- **Byte 11:**  
**Touch Width** reports the width of the detected touch when TCHGEOMEN is set to 1.  
Reserved when TCHGEOMEN is set to 0
- **Byte 13:**  
**Touch Height** reports the height of the detected touch when TCHGEOMEN is set to 1.  
Reserved when TCHGEOMEN is set to 0
- **Byte 15 to 16:**  
**Scan Time** is the timestamp associated with the current report packet (10 kHz resolution).
- **Byte 17:**  
**Count** is the number of active touches to be sent in one package, for the first touch only. Subsequent packets for subsequent active touches have a Count of 0.

## 9.6.3 MAXIMUM TOUCHES REPORT

Read this report to receive the maximum number of touches (surface contacts) that can currently be reported.

Write this report to set the maximum number of touches to be reported.

The format of the Maximum Touches report packet is shown in [Figure 9-15](#). Each Maximum Touch report is 18 bytes long and contains a single byte giving the maximum number of touches to be reported.

**FIGURE 9-15: MAXIMUM TOUCHES REPORT FORMAT**

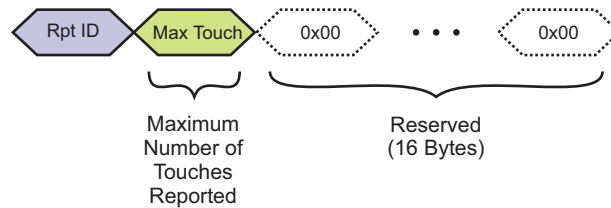

In [Figure 9-15](#):

- **Rpt ID** is the HID-I<sup>2</sup>C report ID used for Maximum Touches reports (see [Table 9-2 on page 32](#)).
- **Max Touch** is the maximum number of touches to be reported by the device.

**NOTE** The number of touches cannot be set to more than the maximum number of touches configured in the device by the Multiple Touch Touchscreen T100 object.

## 9.7 $\overline{\text{CHG}}$ line

The  $\overline{\text{CHG}}$  line is an active-low, open-drain output that is used as an interrupt to alert the host that the client is ready to send a response or that an OBP message is pending and ready to be read from the host.

In order to comply with the HID-I<sup>2</sup>C specification, the  $\overline{\text{CHG}}$  line should be a level-triggered interrupt (that is, Mode 1 operation should be used for the  $\overline{\text{CHG}}$  line; see [Section 8.5 “CHG Line”](#)). The  $\overline{\text{CHG}}$  line will be pulled low when a report is ready and will remain low as long as there are further reports to be read. Once the last report is read the  $\overline{\text{CHG}}$  line will go high.

## 9.8 SDA, SCL

Identical to standard I<sup>2</sup>C operation. See [Section 8.6 “SDA and SCL”](#).

## 9.9 Clock Stretching

Identical to standard I<sup>2</sup>C operation. See [Section 8.7 “Clock Stretching”](#).

## 9.10 Power Control

The mXT640UD-CCU001 supports the use of the HID-I<sup>2</sup>C *SET POWER* commands to put the device into a low power state.

## 9.11 Microsoft Windows Compliance

The mXT640UD-CCU001 has algorithms within the Multiple Touch Touchscreen T100 object specifically to ensure compliance with Microsoft Windows 8.x and later versions.

These, and other device features, may need specific tuning.



## 10.0 PCB DESIGN CONSIDERATIONS

### 10.1 Introduction

The following sections give the design considerations that should be adhered to when designing a PCB layout for use with the mXT640UD-CCU001. Of these, power supply and ground tracking considerations are the most critical.

By observing the following design rules, and with careful preparation for the PCB layout exercise, designers will be assured of a far better chance of success and a correctly functioning product.

### 10.2 Printed Circuit Board

Microchip recommends the use of a four-layer printed circuit board for mXT640UD-CCU001 applications. This, together with careful layout, will ensure that the board meets relevant EMC requirements for both noise radiation and susceptibility, as laid down by the various national and international standards agencies.

#### 10.2.1 PCB CLEANLINESS

Modern no-clean-flux is generally compatible with capacitive sensing circuits.

**CAUTION!** If a PCB is reworked to correct soldering faults relating to any device, or to any associated traces or components, be sure that you fully understand the nature of the flux used during the rework process. Leakage currents from hygroscopic ionic residues can stop capacitive sensors from functioning. If you have any doubts, a thorough cleaning after rework may be the only safe option.

### 10.3 Power Supply

#### 10.3.1 SUPPLY QUALITY

While the device has good Power Supply Rejection Ratio properties, poorly regulated and/or noisy power supplies can significantly reduce performance.

Particular care should be taken of the AVdd supply, as it supplies the sensitive analog stages in the device.

#### 10.3.2 SUPPLY RAILS AND GROUND TRACKING

Power supply and clock distribution are the most critical parts of any board layout. Because of this, it is advisable that these be completed before any other tracking is undertaken. After these, supply decoupling, and analog and high speed digital signals should be addressed. Track widths for all signals, especially power rails should be kept as wide as possible in order to reduce inductance.

The Power and Ground planes themselves can form a useful capacitor. Flood filling for either or both of these supply rails, therefore, should be used where possible. It is important to ensure that there are no floating copper areas remaining on the board: all such areas should be connected to the ground plane. The flood filling should be done on the outside layers of the board.

#### 10.3.3 POWER SUPPLY DECOUPLING

Decoupling capacitors should be fitted as specified in [Section 2.2 "Schematic Notes"](#).

The decoupling capacitors must be placed as close as possible to the pin being decoupled. The traces from these capacitors to the respective device pins should be wide and take a straight route. They should be routed over a ground plane as much as possible. The capacitor ground pins should also be connected directly to a ground plane.

Surface mounting capacitors are preferred over wire-leaded types due to their lower ESR and ESL. It is often possible to fit these decoupling capacitors underneath and on the opposite side of the PCB to the digital ICs. This will provide the shortest tracking, and most effective decoupling possible.

#### 10.3.4 VOLTAGE PUMP

The traces for the voltage pump capacitors between EXTCAP1 and EXTCAP2 and between EXTCAP0 and EXTCAP3 (Cd and Ct on the schematic in [Section 2.0 "Schematics"](#)) should be kept as short and as wide as possible for best pump performance. They should also be routed as parallel and as close as possible to each other in order to reduce emissions, and ideally the traces should be the same length.

# mXT640UD-CCU001 1.0

## 10.3.5 VOLTAGE REGULATORS

Each supply rail requires a Low Drop-Out (LDO) voltage regulator, although an LDO can be shared where supply rails share the same voltage level.

Figure 10-1 shows an example circuit for an LDO.

**FIGURE 10-1: EXAMPLE LDO CIRCUIT**

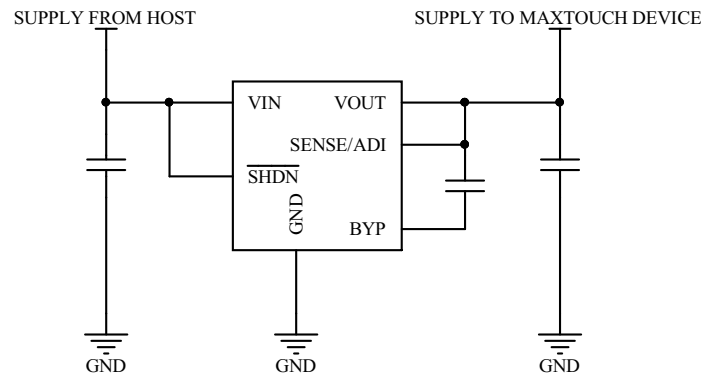

An LDO regulator should be chosen that provides adequate output capability, low noise, no-load stability, good load regulation and step response. The mXT640UD-CCU001 has been qualified for use only with the Microchip LDOs listed in Table 10-1. However, some alternative LDOs with similar specifications are listed in Table 10-2. Microchip has not tested this maXTouch controller with any of these alternative LDOs. Microchip cannot guarantee the functionality or performance of this maXTouch controller with these or any other LDO besides those listed in Table 10-1.

**NOTE** Microchip recommends that a minimum of a 1.0  $\mu\text{F}$  ceramic, low ESR capacitor at the input and output of these devices is always used. The datasheet for the device should always be referred to when selecting capacitors and the typical recommended values, types and dielectrics adhered to.

Sufficient output capacitance should be provided such that the output rate of rise is compatible with the mXT640UD-CCU001 power rail specifications (see Section 13.2.1 “DC Characteristics”). This can be achieved by a combination of output capacitance on the pins of the LDO and bulk capacitance at the inputs to the mXT640UD-CCU001.

**TABLE 10-1: LDO REGULATORS – QUALIFIED FOR USE**

Manufacturer	Device	Current Rating (mA)
Microchip Technology Inc.	MCP1824	300
Microchip Technology Inc.	MCP1824S	300
Microchip Technology Inc.	MAQ5300	300
Microchip Technology Inc.	MCP5504	300
Microchip Technology Inc.	MCP1725	500
Microchip Technology Inc.	MIC5514	300
Microchip Technology Inc.	MIC5323	300

**TABLE 10-2: LDO REGULATORS – OTHER DEVICES**

Manufacturer	Device	Current Rating (mA)
Analog Devices	ADP122/ADP123	300
Diodes Inc.	AP2125	300
Diodes Inc.	AP7335	300

TABLE 10-2: LDO REGULATORS – OTHER DEVICES (CONTINUED)

Manufacturer	Device	Current Rating (mA)
Linear Technology	LT1763CS8-3.3	500
NXP	LD6836	300
Texas Instruments	LP3981	300

### 10.3.6 SINGLE SUPPLY OPERATION

When designing a PCB for an application using a single LDO, extra care should be taken to ensure short, low inductance traces between the supply and the touch controller supply input pins. Ideally, tracking for the individual supplies should be arranged in a star configuration, with the LDO at the junction of the star. This will ensure that supply current variations or noise in one supply rail will have minimum effect on the other supplies. In applications where a ground plane is not practical, this same star layout should also apply to the power supply ground returns.

Only regulators with a 300 mA or greater rating can be used in a single-supply design.

Refer to the following application note for more information:

- Application Note: MXTAN0208 – *Design Guide for PCB Layouts for maXTouch Touch Controllers*

### 10.3.7 MULTIPLE VOLTAGE REGULATOR SUPPLY

The AVdd supply stability is critical for the device because this supply interacts directly with the analog front end. If noise problems exist when using a single LDO regulator, Microchip recommends that AVdd is supplied by a regulator that is separate from the digital supply. This reduces the amount of noise injected into the sensitive, low signal level parts of the design.

## 10.4 Driven Shield Line

The driven shield line is used to provide a guard track around the touchscreen panel that serves as Ground in mutual capacitance operation and as a driven shield in self capacitance operation.

The guard track must be routed between the groups of X tracks and the groups of Y tracks, as well as between the combined group of X/Y tracks and Ground. It should be fairly wide to avoid X-to-Y coupling in mutual capacitance operation, as the guard track will act as Ground in this circumstance.

A guard track is also needed between any self capacitance X/Y lines and mutual capacitance only X/Y lines (for example, between Multiple Touch Touchscreen T100 and Key Array T15 lines).

**FIGURE 10-2: EXAMPLE DRIVEN SHIELD ROUTING**

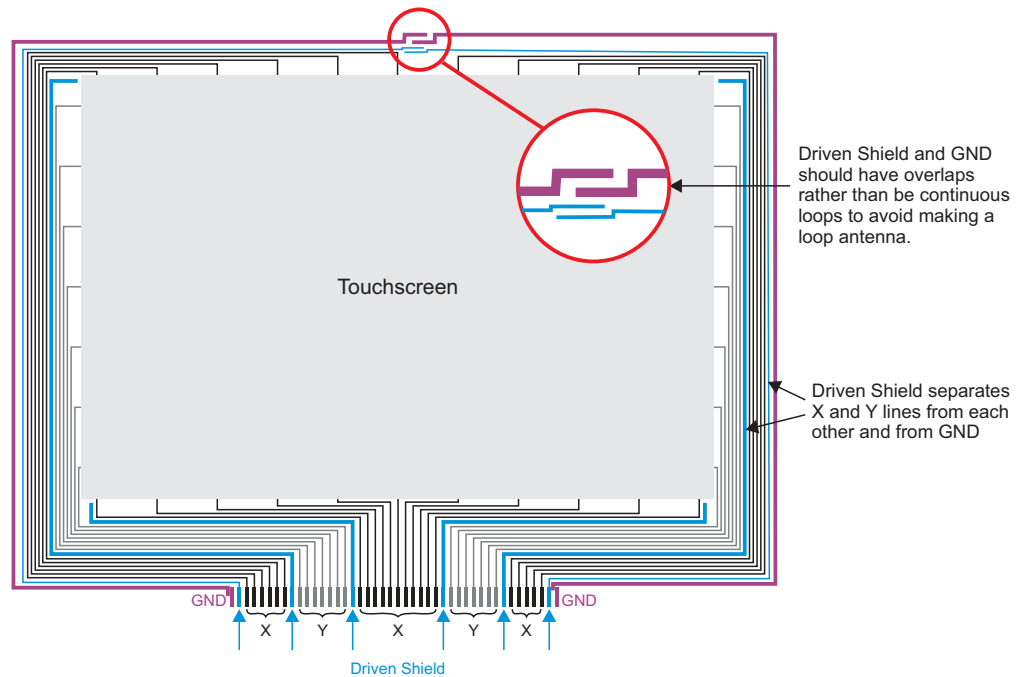

NOTE: Sample touchscreen for illustrative purposes only. The number of X/Y lines available on any given device might differ from that shown here. Similarly, the routing of the X/Y lines shown should not be taken as indicative of any preferred layout and the user's layout may vary.

## 10.5 ESD Ground Routing

To avoid damage due to ESD strikes, the outermost track on the sensor should be an ESD ground (see [Figure 10-2](#)). Like the driven shield, this should completely surround the sensor but with an overlap at the top rather than forming a complete loop.

To avoid electromagnetic induction of currents into the driven shield trace, a minimum separation of 0.3 mm should be maintained between the ESD GND trace and the Driven Shield.

The ESD ground traces should be connected to a dedicated ground trace in the PCB, and routed such that ESD strike currents do not flow under or close to the touch controller or the connecting wiring between it and the touchscreen array. The ESD ground should be connected in to the main system ground at a star point at the main GND connection to the PCB.

See also:

- MXTAN0208 – *Design guide for PCB Layouts for maXTouch Touch Controllers*

## 10.6 Analog I/O

In general, tracking for the analog I/O signals from the device should be kept as short as possible. These normally go to a connector which interfaces directly to the touchscreen.

Ensure that adequate ground-planes are used. An analog ground plane should be used in addition to a digital one. Care should be taken to ensure that both ground planes are kept separate and are connected together only at the point of entry for the power to the PCB. This is usually at the input connector.

## 10.7 Component Placement and Tracking

It is important to orient all devices so that the tracking for important signals (such as power and clocks) are kept as short as possible.

### 10.7.1 DIGITAL SIGNALS

In general, when tracking digital signals, it is advisable to avoid sharp directional changes on sensitive signal tracks (such as analog I/O) and any clock or crystal tracking.

A good ground return path for all signals should be provided, where possible, to ensure that there are no discontinuities.

## 10.8 EMC and Other Observations

The following recommendations are not mandatory, but may help in situations where particularly difficult EMC or other problems are present:

- Try to keep as many signals as possible on the inside layers of the board. If suitable ground flood fills are used on the top and bottom layers, these will provide a good level of screening for noisy signals, both into and out of the PCB.
- Ensure that the on-board regulators have sufficient tracking around and underneath the devices to act as a heatsink. This heatsink will normally be connected to the 0 V or ground supply pin. Increasing the width of the copper tracking to any of the device pins will aid in removing heat. There should be no solder mask over the copper track underneath the body of the regulators.
- Ensure that the decoupling capacitors, especially high capacity ceramic type, have the requisite low ESR, ESL and good stability/temperature properties. Refer to the regulator manufacturer's datasheet for more information.

## 11.0 GETTING STARTED WITH MXT640UD-CCU001

### 11.1 Establishing Contact

#### 11.1.1 COMMUNICATION WITH THE HOST

The host can use any of the following interfaces to communicate with the device (See [Section 7.0 “Host Communications”](#)):

- I<sup>2</sup>C interface (see [Section 8.0 “I<sup>2</sup>C Communications”](#))
- HID-I<sup>2</sup>C interface (see [Section 9.0 “HID-I<sup>2</sup>C Communications”](#))

#### 11.1.2 POWER-UP SEQUENCE

The power-up sequence is as follows:

1. On power-up, the  $\overline{\text{CHG}}$  line goes low to indicate that there is new data to be read from the device. If the  $\overline{\text{CHG}}$  line does not go low within a suitable timeout, there is a problem with the device. The timeout should be chosen to be, for example, three times the relevant typical values for the system as defined in [Section 13.5.3 “Reset Timings”](#) (for example, 1300 ms if all POST tests are performed).
2. Once the  $\overline{\text{CHG}}$  line goes low, the host should attempt to read the first 7 bytes of memory from location 0x0000 to establish that the device is present and running following power-up. These bytes represent the ID Information portion of the Information Block and should be recorded by the host so it can read the Object Table (see [Section 11.2 “Using the Object-based Protocol”](#)).
3. The device performs a checksum on the configuration settings held in the non-volatile memory. If the checksum does not match a stored copy of the last checksum, then this indicates that the settings have become corrupted. The host should write a correct configuration to the device, and issue a Command Processor T6 Backup command, if the read checksum does not match the expected checksum, or if the configuration error bit in the message data from the Command Processor T6 object is set.

Once the device has been initialized, the host must perform the following initialization so that it can communicate with the device:

1. Read the start positions of all the objects in the device from the Object Table and build up a list of these addresses. Note that the number of elements was read by the host at start-up as part of the ID Information bytes.
2. Use the Object Table to calculate the report IDs so that messages from the device can be correctly interpreted.
3. Read any pending messages generated during the start-up process.

Refer to Application Note MXTAN0213, *Interfacing with maXTouch Touchscreen Controllers*, for more information.

### 11.2 Using the Object-based Protocol

The device has an object-based protocol (OBP) that is used to communicate with the device. Typical communication includes configuring the device, sending commands to the device, and receiving messages from the device.

#### 11.2.1 CLASSES OF OBJECTS

The mXT640UD-CCU001 contains the following classes of objects:

- **Debug objects** – provide a raw data output method for development and testing.
- **General objects** – required for global configuration, transmitting messages and receiving commands.
- **Touch objects** – operate on measured signals from the touch sensor and report touch data.
- **Signal processing objects** – process data from other objects (typically signal filtering operations).
- **Support objects** – provide additional functionality on the device.

11.2.2 OBJECT INSTANCES

**TABLE 11-1: OBJECTS ON THE MXT640UD-CCU001**

Object	Description	Number of Instances	Usage
<b>Debug Objects</b>			
Diagnostic Debug T37	Allows access to diagnostic debug data to aid development.	1	Debug commands only; Read-only object. No configuration or tuning necessary. Not for use in production.
<b>General Objects</b>			
Message Processor T5	Handles the transmission of messages. This object holds a message in its memory space for the host to read.	1	No configuration necessary.
Command Processor T6	Performs a command when written to. Commands include reset, calibrate and backup settings.	1	No configuration necessary.
Power Configuration T7	Controls the sleep mode of the device. Power consumption can be lowered by controlling the acquisition frequency and the sleep time between acquisitions.	1	Must be configured before use.
Acquisition Configuration T8	Controls how the device takes each capacitive measurement.	1	Must be configured before use.
<b>Touch Objects</b>			
Key Array T15	Defines a rectangular array of keys. A Key Array T15 object reports simple on/off touch information.	1	Enable and configure as required.
Multiple Touch Touchscreen T100	Creates a touchscreen that supports the tracking of more than one touch.	1	Enable and configure as required.
<b>Signal Processing Objects</b>			
Key Thresholds T14	Allows different thresholds to be specified for each key in a Key Array.	1	Configure as required.
Key ID Configuration T16	Controls the reporting of Key Array T15 keys.	1	Enable and configure as required.
One-touch Gesture Processor T24	Operates on the data from a Touchscreen object. A One-touch Gesture Processor T24 converts touches into one-touch finger gestures (for example, taps, double taps and drags).	1	Enable and configure as required.
Two-touch Gesture Processor T27	Operates on the data from a One-touch Gesture Processor T24 object. A Two-touch Gesture Processor T27 converts touches into two-touch finger gestures (for example, pinches, stretches and rotates).	1	Enable and configure as required.
Grip Suppression T40	Suppresses false detections caused, for example, by the user gripping the edge of a touchscreen.	1	Enable and configure as required.
Touch Suppression T42	Suppresses false detections caused by unintentional large touches by the user.	1	Enable and configure as required.
Passive Stylus T47	Processes passive stylus input.	1	Enable and configure as required.
Shieldless T56	Allows a sensor to use true single-layer coplanar construction.	1	Enable and configure as required.

**TABLE 11-1: OBJECTS ON THE MXT640UD-CCU001 (CONTINUED)**

Object	Description	Number of Instances	Usage
Lens Bending T65	Compensates for lens deformation (lens bending) by attempting to eliminate the disturbance signal from the reported deltas.	3	Enable and configure as required.
Noise Suppression T72	Performs various noise reduction techniques during sensor signal acquisition.	1	Enable and configure as required.
Glove Detection T78	Allows for the reporting of glove touches.	1	Enable and configure as required.
Retransmission Compensation T80	Limits the negative effects on touch signals caused by poor device coupling to ground or moisture on the sensor.	1	Enable and configure as required.
Self Capacitance Noise Suppression T108	Suppresses the effects of external noise within the context of self capacitance touch measurements.	1	Enable and configure as required.
Self Capacitance Grip Suppression T112	Allows touches to be reported from the self capacitance measurements while the device is being gripped.	1	Enable and configure as required.
Ignore Nodes T141	Defines a set of sensor nodes that are to be excluded from normal processing.	32	Configure as required
<b>Support Objects</b>			
Self Test Control T10	Controls the self-test routines to find faults on the device.	1	Enable and configure as required.
Self Test Pin Faults T11	Specifies the configuration settings for the Pin Fault self tests.	1	Configure as required.
Self Test Signal Limits T12	Specifies the configuration settings for the Signal Limit self tests.	2	Configure as required.
Communications Configuration T18	Configures additional communications behavior for the device.	1	Check and configure as necessary.
GPIO Configuration T19	Allows the host controller to configure and use the general purpose I/O pins on the device.	1	Enable and configure as required.
User Data T38	Provides a data storage area for user data.	1	Configure as required.
Digitizer HID Configuration T43	Configures the Digitizer HID interface and the Descriptors associated with it.	1	Enable and configure as required.
Message Count T44	Provides a count of pending messages.	1	Read-only object.
CTE Configuration T46	Controls the capacitive touch engine for the device.	1	Must be configured.
Timer T61	Provides control of a timer.	6	Enable and configure as required.
Serial Data Command T68	Provides an interface for the host driver to deliver various data sets to the device.	1	Enable and configure as required.
Dynamic Configuration Controller T70	Allows rules to be defined that respond to system events.	20	Enable and configure as required.
Dynamic Configuration Container T71	Allows the storage of user configuration on the device that can be selected at runtime based on rules defined in the Dynamic Configuration Controller T70 object.	1	Configure if Dynamic Configuration Controller T70 is in use.
Touch Event Trigger T79	Configures touch triggers for use with the event handler.	3	Enable and configure as required.



**TABLE 11-1: OBJECTS ON THE MXT640UD-CCU001 (CONTINUED)**

Object	Description	Number of Instances	Usage
Auxiliary Touch Configuration T104	Allows the setting of self capacitance gain and thresholds for a particular measurement to generate auxiliary touch data for use by other objects.	1	Enable and configure if using self capacitance measurements
Self Capacitance Global Configuration T109	Provides configuration for self capacitance measurements employed on the device.	1	Check and configure as required (if using self capacitance measurements).
Self Capacitance Tuning Parameters T110	Provides configuration space for a generic set of settings for self capacitance measurements.	12	Use under the guidance of Microchip field engineers only.
Self Capacitance Configuration T111	Provides configuration for self capacitance measurements employed on the device.	2	Check and configure as required (if using self capacitance measurements).
Self Capacitance Measurement Configuration T113	Configures self capacitance measurements to generate data for use by other objects.	1	Enable and configure as required.
Data Container T117	Provides a mechanism for retrieving specific data held in the device's internal memory.	6	Read-only object. No configuration necessary.
Data Container Controller T118	Provides direct access to internal data in memory for use with the Data Container T117 objects.	1	Enable and configure as required.
Self Capacitance Voltage Modulation T133	Controls the voltage modulation on self capacitance scans.	2	Enable and configure as required.
Ignore Nodes Controller T145	Specifies how ignored nodes configured in Ignore Nodes T141 are applied to various measurement processes on the device.	1	Configure as required

### 11.2.3 CONFIGURING AND TUNING THE DEVICE

The objects are designed such that a default value of zero in their fields is a “safe” value that typically disables functionality. The objects must be configured before use and the settings written to the non-volatile memory using the Command Processor T6 object.

Perform the following actions for each object:

1. Enable the object, if the object requires it.
2. Configure the fields in the object, as required.
3. Enable reporting, if the object supports messages, to receive messages from the object.

### 11.3 Writing to the Device

The following mechanisms can be used to write to the device:

- Using an I<sup>2</sup>C write operation (see [Section 8.2 “Writing To the Device”](#)).
- Using the Generic HID-I<sup>2</sup>C write operation (see [Section 9.5.1.2 “Writing To the Device”](#)).

Communication with the device is achieved by writing to the appropriate object:

- To send a command to the device, an appropriate command is written to the Command Processor T6 object.
- To configure the device, a configuration parameter is written to the appropriate object. For example, writing to the Power Configuration T7 configures the power consumption for the device and writing to the Multiple Touch Touchscreen T100 object sets up the touchscreen. Some objects are optional and need to be enabled before use.

**IMPORTANT!** When the host issues any command within an object that results in a flash write to the device Non-Volatile Memory (NVM), that object should have its CTRL RPTEN bit set to 1, if it has one. This ensures that a message from the object writing to the NVM is generated at the completion of the process and an assertion of the  $\overline{\text{CHG}}$  line is executed.

The host must also ensure that the assertion of the  $\overline{\text{CHG}}$  line refers to the expected object report ID before asserting the  $\overline{\text{RESET}}$  line to perform a reset. Failure to follow this guidance may result in a corruption of device configuration area and the generation of a CFGERR.

## 11.3.1 WRITING A CONFIGURATION TO THE DEVICE

During a configuration download, device operation may be based upon only part of that configuration because it is yet to finish downloading. In rare circumstances, the total processing time might exceed the WDT reset time. This is more likely to happen when measurements take a long time to perform due to the partial configuration.

To ensure that the configuration is written safely, follow these steps:

1. Set Power Configuration T7 IDLEACQINT and ACTVACQINT to 0 (that is, deep sleep) as a temporary measure.
2. Download the rest of the configuration, except those Power Configuration T7 controls.
3. Finally, set the Power Configuration T7 acquisition interval controls to the required values.

## 11.4 Reading from the Device

Status information is stored in the Message Processor T5 object. This object can be read to receive any status information from the device.

The following mechanisms provide an interrupt-style interface for reading messages in the Message Processor T5 object:

- In I<sup>2</sup>C mode, the  $\overline{\text{CHG}}$  line is asserted whenever a new message is available in the Message Processor T5 object (see [Section 8.5 “CHG Line”](#)). See [Section 8.4 “Reading From the Device”](#) for information on the format of the I<sup>2</sup>C read operation.
- In HID-I<sup>2</sup>C mode, the interface provides an interrupt-driven interface that sends the messages automatically (see [Section 9.5.1.3 “Reading From the Device”](#)).

**NOTE** The host should always wait to be notified of messages; the host should not poll the device for messages (either by polling the Message Processor T5 object or by polling the  $\overline{\text{CHG}}$  line).

---

## 12.0 DEBUGGING AND TUNING

### 12.1 Hardware Debug Interface

The Hardware Debug Interface is used for tuning and debugging when running the system and allows the development engineer to use Microchip maXTouch Studio to read the real-time raw data. This uses the low-level debug port.

The Hardware Debug Interface consists of the DBG\_CLK and DBG\_DATA lines. These lines should be routed to test points on all designs such that they can be connected to external hardware during system development. These lines should not be connected to power or GND. See [Section 2.2.10 “Hardware Debug Interface”](#) for more details.

The Hardware Debug Interface is enabled by the Command Processor T6 object and by default will be off.

<b>NOTE</b> When the DBG_CLK and DBG_DATA lines are in use for debugging, any alternative function for the pins cannot be used. The touch controller will take care of the pin configuration.
---

### 12.2 Object-based Protocol

The device provides a mechanism for obtaining debug data for development and testing purposes by reading data from the Diagnostic Debug T37 object.

<b>NOTE</b> The Diagnostic Debug T37 object is of most use for simple tuning purposes. When debugging a design, it is preferable to use the Hardware Debug Interface, as this will have a much higher bandwidth and can provide real-time data.
---

### 12.3 Self Test

The Self Test Control T10, Self Test Pin Faults T11 and Self Test Signal Limits T12 objects run self-test routines in the device to find hardware faults in the device both at power-on/reset and during normal operation. These self-test routines can be configured to check the CPU, clock, memory and power supplies of the devices, as well as CTE operation and the signal levels. The tests can also check for pin shorts between sensor X and Y pins, and between the sensor lines and DS0, power or GND pins.

In addition to one-off hardware tests, the Self Test Control T10 object can also provide continuous monitoring of the health of the device while it is in operation. A periodic Built-In Self Test (BIST) test can be run at a user-specified interval and reports the global pass and/or specific fail messages (as determined by the device configuration). Reporting is achieved either by standard Self Test Control T10 object protocol messages or by a configurable hardware GPIO pin, configured using the GPIO Configuration T19 object.

# mXT640UD-CCU001 1.0

## 13.0 SPECIFICATIONS

### 13.1 Absolute Maximum Specifications

Vdd	3.6V
VddIO	3.6V
AVdd	3.6V
Maximum continuous combined pin current, all GPIO <sub>n</sub> pins	40 mA
Voltage forced onto any pin	-0.3 V to (Vdd, VddIO or AVdd) + 0.3 V
Configuration parameters maximum writes	10,000
Maximum junction temperature	125°C

**CAUTION!** Stresses beyond those listed under *Absolute Maximum Specifications* may cause permanent damage to the device. This is a stress rating only and functional operation of the device at these or other conditions beyond those indicated in the operational sections of this specification is not implied. Exposure to absolute maximum specification conditions for extended periods may affect device reliability.

### 13.2 Recommended Operating Conditions

Operating temperature	-40°C to +85°C
Storage temperature	-60°C to +150°C
Vdd	3.3 V ±5%
VddIO	1.8 V to 3.3 V
AVdd	3.3 V ±5%
XVdd with internal voltage doubler	2 × Vdd
XVdd with internal voltage tripler	3 × Vdd
Temperature slew rate	10°C/min

## 13.2.1 DC CHARACTERISTICS

### 13.2.1.1 Analog Voltage Supply – AVdd

Parameter	Min	Typ	Max	Units	Notes
<b>AVdd</b>					
Operating limits	3.14	3.3	3.47	V	
Supply Rise Rate	–	–	0.25	V/μs	For example, for a 3.3 V rail, the voltage should take a minimum of 13.2 μs to rise

### 13.2.1.2 Digital Voltage Supply – VddIO, Vdd

Parameter	Min	Typ	Max	Units	Notes
<b>VddIO</b>					
Operating limits	1.71	3.3	3.47	V	
Supply Rise Rate	–	–	0.25	V/μs	For example, for a 3.3 V rail, the voltage should take a minimum of 13.2 μs to rise
<b>Vdd</b>					
Operating limits	3.14	3.3	3.47	V	
Supply Rise Rate	–	–	0.25	V/μs	For example, for a 3.3 V rail, the voltage should take a minimum of 13.2 μs to rise
Supply Fall Rate	–	–	0.05	V/μs	For example, for a 3.3 V rail, the voltage should take a minimum of 66 μs to fall

### 13.2.1.3 XVdd Voltage Supply – XVdd

Parameter	Min	Typ	Max	Units	Notes
<b>XVdd</b>					
Operating limits – voltage doubler enabled	–	2 × Vdd	–	V	
Operating limits – voltage tripler enabled	–	3 × Vdd	–	V	

## 13.2.2 POWER SUPPLY RIPPLE AND NOISE

Parameter	Min	Typ	Max	Units	Notes
Vdd	–	–	±50	mV	Across frequency range 1 Hz to 1 MHz
AVdd	–	–	±40	mV	Across frequency range 1 Hz to 1 MHz, with Noise Suppression enabled

# mXT640UD-CCU001 1.0

## 13.3 Test Configuration

The configuration values listed below were used in the reference unit to validate the interfaces and derive the characterization data provided in the following sections.

**TABLE 13-1: TEST CONFIGURATION**

Object/Parameter	Description/Setting (Numbers in Decimal)
Power Configuration T7	
CFG2	0 (Power Monitor Enabled)
Acquisition Configuration T8	
CHRGTIME	25
MEASALLOW	3
Self Test Control T10	Object Enabled; Reporting Enabled; POST Reporting Enabled BIST Reporting Disabled
Key Array T15	Object Enabled; Reporting Enabled
XSIZE	1
YSIZE	3
GPIO Configuration T19	Object Enabled
One-touch Gesture Processor T24	Object Enabled
Two-touch Gesture Processor T27	Object Enabled
Touch Suppression T42	Object Enabled
CTE Configuration T46	
IDLESYNCSPERX	8
ACTVSYNCSPERX	8
Passive Stylus T47	Object Enabled
Lens Bending T65 Instance 0	Object Instance Enabled
Lens Bending T65 Instance 1	Object Instance Enabled
Lens Bending T65 Instance 2	Object Instance Enabled
Noise Suppression T72	Object Enabled
Glove Detection T78	Object Enabled
Retransmission Compensation T80	Object Enabled
Multiple Touch Touchscreen T100	Object Enabled; Reporting Enabled
XSIZE	32
YSIZE	20
Auxiliary Touch Configuration T104	Object Enabled
Self Capacitance Noise Suppression T108	Object Enabled
Self Capacitance Configuration T111 Instance 0	
INTTIME	50
IDLESYNCSPERL	12
ACTVSYNCSPERL	12
Self Capacitance Configuration T111 Instance 1	
INTTIME	50
IDLESYNCSPERL	16
ACTVSYNCSPERL	16

13.4 Current Consumption – I<sup>2</sup>C Interface

**NOTE** The characterization charts show typical values based on the configuration in [Table 13-1](#). In particular, BIST processing has been disabled. Actual power consumption in the user’s application will depend on the circumstances of that particular project and will vary from that shown here. Further tuning will be required to achieve an optimal performance.

13.4.1 AVDD

Acquisition Rate (ms)	Current Consumption (mA)				
	0 Touches	1 Touch	2 Touches	5 Touches	10 Touches
Free-run	9.5	8.2	8.2	7.6	7.2
10	7	6.4	6.4	6.5	6.5
16	4.4	4	4.1	4	4.1
32	2.2	2	2.1	2	2.1
64	1.1	1	1	1	1
128	0.7	0.6	0.6	0.6	0.6
254	0.3	0.3	0.3	0.3	0.3

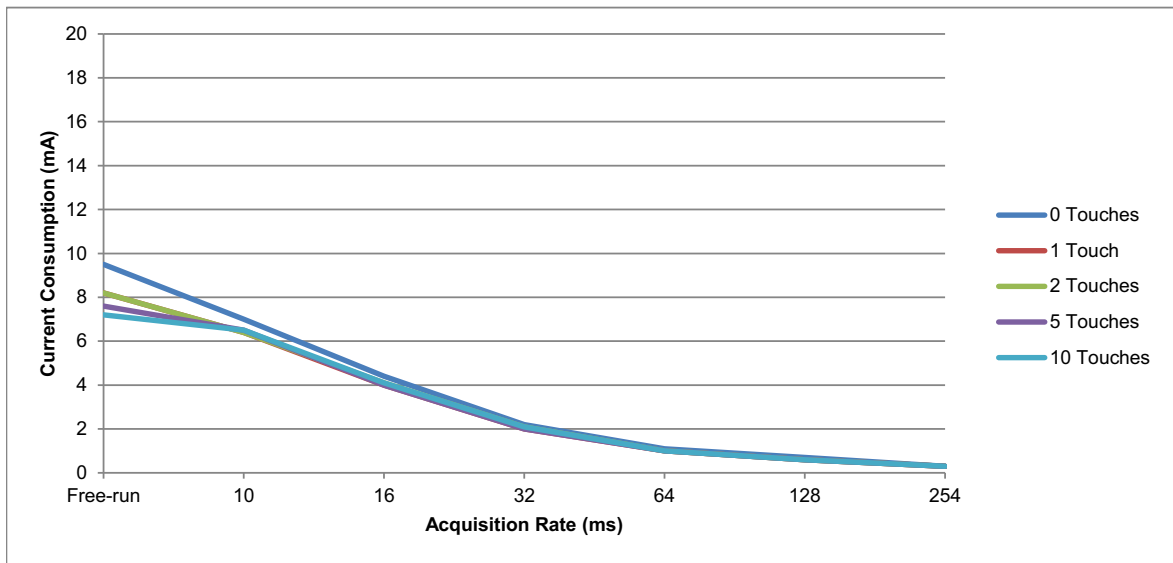

# mXT640UD-CCU001 1.0

## 13.4.2 VDD

Acquisition Rate (ms)	Current Consumption (mA)				
	0 Touches	1 Touch	2 Touches	5 Touches	10 Touches
Free-run	8.3	8.8	9.1	9.8	10.8
10	6.2	7.1	7.4	8.7	9.8
16	4	4.5	4.7	5.4	6.1
32	2.1	2.4	2.5	2.8	3.2
64	1.2	1.3	1.4	1.6	1.8
128	0.8	0.8	0.8	0.9	1
254	0.5	0.5	0.5	0.6	0.7

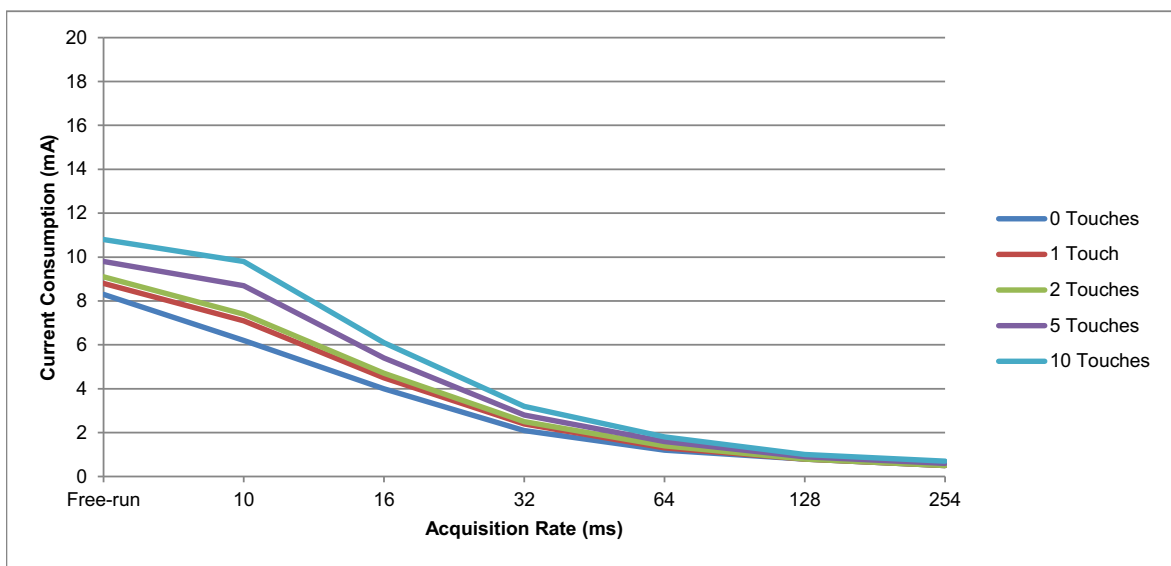



13.4.3 VDDIO

Acquisition Rate (ms)	Current Consumption (mA)				
	0 Touches	1 Touch	2 Touches	5 Touches	10 Touches
Free-run	0.20	0.30	0.30	0.50	0.70
10	0.20	0.30	0.30	0.40	0.60
16	0.20	0.20	0.30	0.40	0.50
32	0.20	0.20	0.30	0.30	0.30
64	0.20	0.20	0.20	0.30	0.30
128	0.20	0.20	0.20	0.20	0.20
254	0.20	0.20	0.20	0.20	0.20

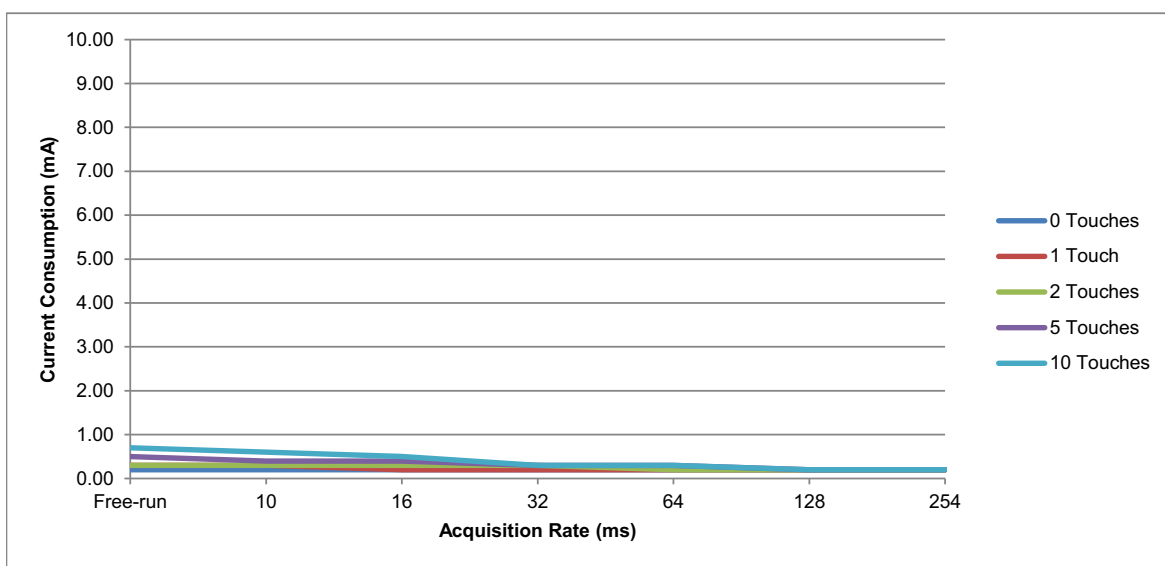

13.4.4 DEEP SLEEP

Power Monitor On;  $T_A = 25^\circ\text{C}$

Parameter	Value	Units	Notes
Deep Sleep Current	0.42	mA	Vdd = 3.3V, AVdd = 3.3V, VddIO = 3.3V
Deep Sleep Power	1.37	mW	

Power Monitor Off;  $T_A = 25^\circ\text{C}$

Parameter	Value	Units	Notes
Deep Sleep Current	0.24	mA	Vdd = 3.3V, AVdd = 3.3V, VddIO = 3.3V
Deep Sleep Power	0.79	mW	

# mXT640UD-CCU001 1.0

## 13.5 Timing Specifications

**NOTE** The figures below show typical values based on the test configuration. Actual timings in the user's application will depend on the circumstances of that particular project and will vary from those shown below. Further tuning will be required to achieve an optimal performance.

### 13.5.1 TOUCH LATENCY

Conditions: XSIZE = 32; YSIZE = 20; CHRGTIME = 25; IDLESYNCSPERX = 8; ACTVSYNCSPERX = 8;  
 T = ambient temperature; Finger center of screen; Reporting Off except T100 and T10

**Idle Primary = Mutual Capacitance; Active Primary = Mutual Capacitance**

T100 TCHDIDOWN	Pipelining Off			Pipelining On			Units
	Min	Typ	Max	Min	Typ	Max	
3	24	29	34	30	41	52	ms
2	15	19.5	24	29	39	49	ms
1	7.4	11.9	16.3	18.1	28.3	38.4	ms
Disabled (DISTCHDIDOWN = 1)	6.5	11.3	16.1	8.5	14.4	20.2	ms

### 13.5.2 REPORT RATE

Conditions: XSIZE = 32; YSIZE = 20; CHRGTIME = 25; IDLESYNCSPERX = 8; ACTVSYNCSPERX = 8; T = ambient temperature

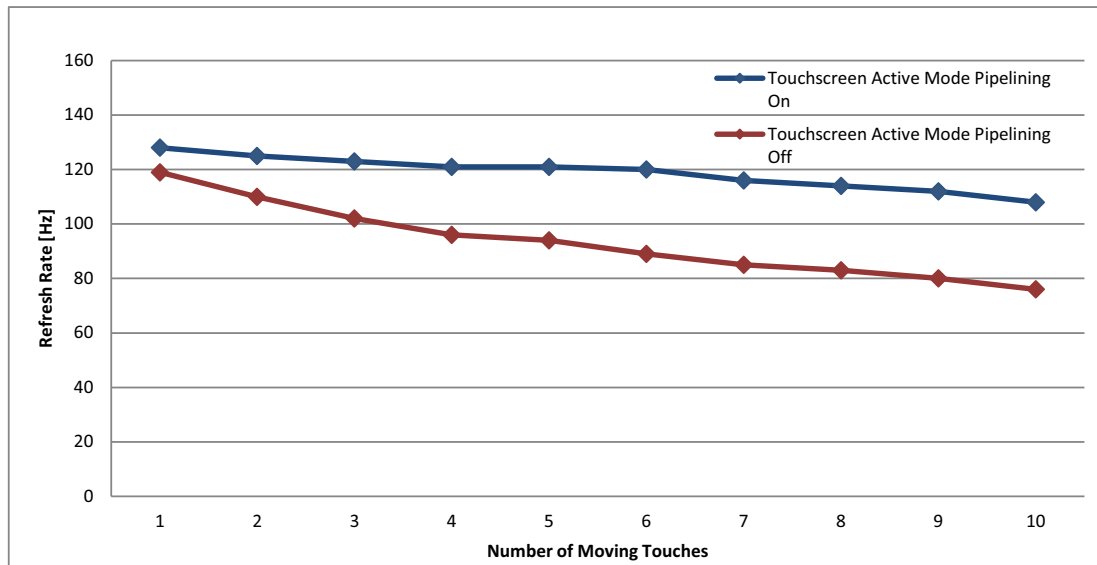

13.5.3 RESET TIMINGS

Parameter	POST Enabled (Typ)	POST Disabled (Typ)	Units	Notes
Power on to $\overline{\text{CHG}}$ line low	430	135	ms	Triggered by Vdd supply at start up
Hardware reset to $\overline{\text{CHG}}$ line low	430	135	ms	Triggered by $\overline{\text{RESET}}$
Software reset to $\overline{\text{CHG}}$ line low	460	155	ms	Triggered by Command Processor T6 Reset command

**Note 1:** Any  $\overline{\text{CHG}}$  line activity before the power-on or reset period has expired should be ignored by the host. Operation of this signal cannot be guaranteed before the power-on/reset periods have expired.

**2:** The mXT640UD-CCU001 meets the requirements of Microsoft Windows 8.x and later versions.

13.6 Touch Accuracy and Repeatability

Parameter	Min	Typ	Max	Units	Notes
Linearity	–	±0.5	–	mm	Finger diameter 8 mm
Accuracy (across all areas of screen)	–	0.5	–	mm	Finger diameter 8 mm
Repeatability	–	±0.25	–	%	X axis with 12-bit resolution

13.7 Touchscreen Sensor Characteristics

Parameter	Description	Min	Typ	Max	Units	Notes
Cm	Mutual capacitance	0.15	–	10	pF	Assumes XVdd ≥ 2 × AVdd. Minimum is 0.3pF with XVdd = AVdd
Cpx	Self capacitance load to X	–	–	100	pF	Single X line
Cpy	Self capacitance load to Y	–	–	100	pF	Single Y line
ΔCpx	Self capacitance imbalance on X	–	–	9.7	pF	Value increases by 1 pF for every 20 pF reduction in Cpx
ΔCpy	Self capacitance imbalance on Y	–	–	9.7	pF	Value increases by 1 pF for every 20 pF reduction in Cpy

13.8 Input/Output Characteristics

Parameter	Description	Min	Typ	Max	Units	Notes
<b>Input (All input pins connected to the VddIO power rail)</b>						
Vil	Low input logic level	–0.3	–	0.3 × VddIO	V	VddIO = 1.8 V to Vdd
Vih	High input logic level	0.7 × VddIO	–	VddIO	V	VddIO = 1.8 V to Vdd
Iil	Input leakage current	–	–	1	μA	Pull-up resistors disabled
$\overline{\text{RESET}}$	Internal pull-up resistor	9	–	16	kΩ	
GPIOs	Internal pull-up/pull-down resistor					
<b>Output (All output pins connected to the VddIO power rail)</b>						
Vol	Low output voltage	0	–	0.2 × VddIO	V	VddIO = 1.8 V to Vdd Iol = 2 mA
Voh	High output voltage	0.8 × VddIO	–	VddIO	V	VddIO = 1.8 V to Vdd Ioh = –2 mA

# mXT640UD-CCU001 1.0

## 13.9 I<sup>2</sup>C Specification

Parameter	Value
Address	0x4B
I <sup>2</sup> C specification <sup>(1)</sup>	Revision 6.0
Maximum bus speed (SCL) <sup>(2)</sup>	3.4 MHz
Standard Mode <sup>(3)</sup>	100 kHz
Fast Mode <sup>(3)</sup>	400 kHz
Fast Mode Plus <sup>(3)</sup>	1 MHz
High Speed Mode <sup>(3)</sup>	3.4 MHz

- Note 1:** More detailed information on I<sup>2</sup>C operation is available from UM10204, *I<sup>2</sup>C bus specification and user manual*, available from NXP
- 2:** In systems with heavily laden I<sup>2</sup>C lines, even with minimum pull-up resistor values, bus speed may be limited by capacitive loading to less than the theoretical maximum.
- 3:** The values of pull-up resistors should be chosen to ensure SCL and SDA rise and fall times meet the I<sup>2</sup>C specification. The value required will depend on the amount of capacitance loading on the lines.

## 13.10 HID-I<sup>2</sup>C Specification

Parameter	Value
Vendor ID	0x03EB (Microchip)
Product ID	0x2195 (mXT640UD-CCU001)
HID-I <sup>2</sup> C specification	1.0

## 13.11 Thermal Packaging

### 13.11.1 THERMAL DATA

Parameter	Description	Typ	Unit	Condition	Package
$\theta_{JA}$	Junction to ambient thermal resistance	51.9	°C/W	Still air	88-ball UFBGA 6 × 6 × 0.6 mm
$\theta_{JC}$	Junction to case thermal resistance	6.5	°C/W		88-ball UFBGA 6 × 6 × 0.6 mm

### 13.11.2 JUNCTION TEMPERATURE

The maximum junction temperature allowed on this device is 125°C.

The average junction temperature in °C ( $T_J$ ) for this device can be obtained from the following:

$$T_J = T_A + (P_D \times \theta_{JA})$$

If a cooling device is required, use this equation:

$$T_J = T_A + (P_D \times (\theta_{HEATSINK} + \theta_{JC}))$$

where:

- $\theta_{JA}$  = package thermal resistance, Junction to ambient (°C/W) (see [Section 13.11.1 “Thermal Data”](#))
- $\theta_{JC}$  = package thermal resistance, Junction to case thermal resistance (°C/W) (see [Section 13.11.1 “Thermal Data”](#))
- $\theta_{HEATSINK}$  = cooling device thermal resistance (°C/W), provided in the cooling device datasheet
- $P_D$  = device power consumption (W)
- $T_A$  is the ambient temperature (°C)

**13.12 ESD Information**

Parameter	Value	Reference Standard
Human Body Model (HBM)	±2000V	JEDEC JS-001
Charge Device Model (CDM)	±250V	JEDEC JS-001

**13.13 Soldering Profile**

Profile Feature	Green Package
Average Ramp-up Rate (217°C to Peak)	3°C/s max
Preheat Temperature 175°C ±25°C	150 – 200°C
Time Maintained Above 217°C	60 – 150 s
Time within 5°C of Actual Peak Temperature	30 s
Peak Temperature Range	260°C
Ramp down Rate	6°C/s max
Time 25°C to Peak Temperature	8 minutes max

**13.14 Moisture Sensitivity Level (MSL)**

MSL Rating	Package Type(s)	Peak Body Temperature	Specifications
MSL3	88-ball UFBGA	260°C	IPC/JEDEC J-STD-020

# mXT640UD-CCU001 1.0

---

## 14.0 PACKAGING INFORMATION

### 14.1 Package Marking Information

#### 14.1.1 88-BALL UFBGA

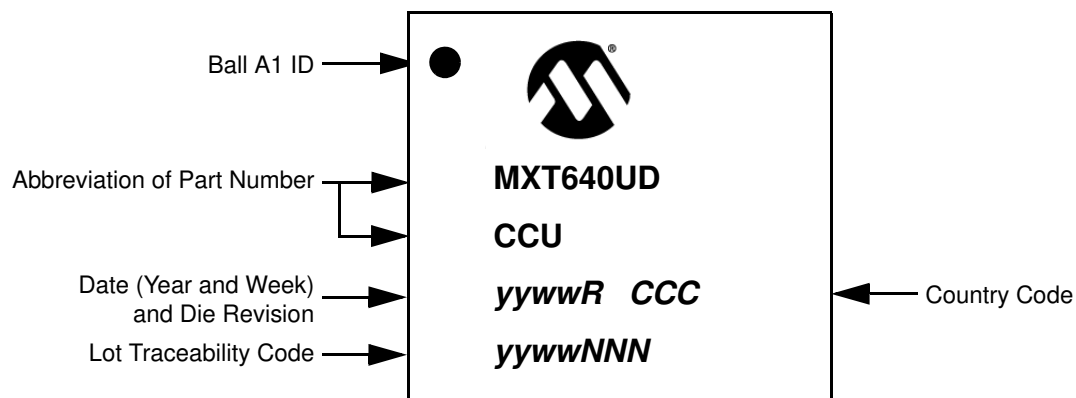

#### 14.1.2 ORDERABLE PART NUMBERS

The product identification system for maXTouch devices is described in "[Product Identification System](#)". That section also lists example part numbers for the device.

14.2 Package Details

**88-Ball Ultra Thin Fine Pitch Ball Grid Array (BVB) - 6x6x0.6 mm Body [UFBGA]**  
**Atmel Legacy Global Package Code CJM**

**Note:** For the most current package drawings, please see the Microchip Packaging Specification located at <http://www.microchip.com/packaging>

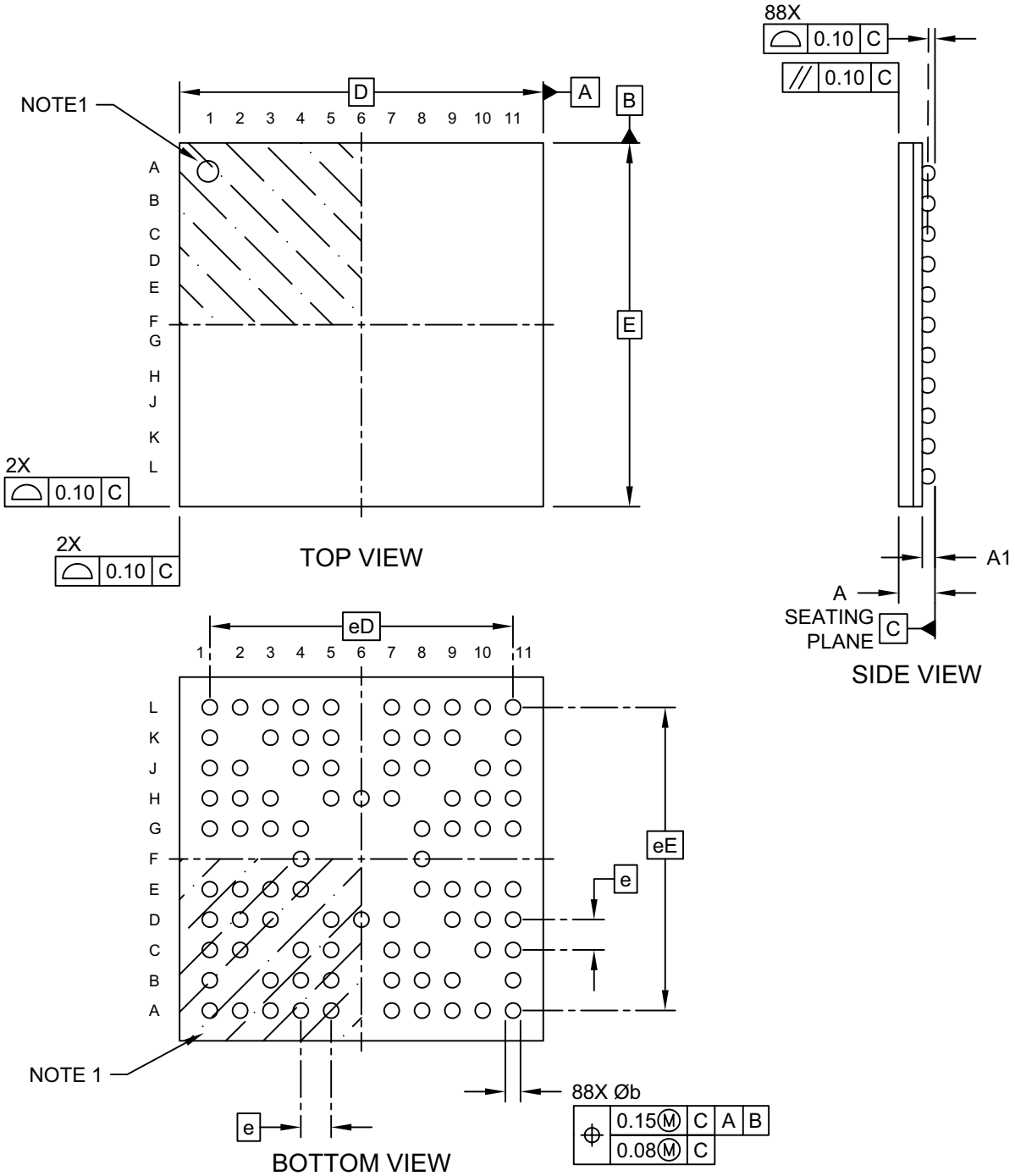

Microchip Technology Drawing C04-21158 Rev A Sheet 1 of 2

# mXT640UD-CCU001 1.0

## 88-Ball Ultra Thin Fine Pitch Ball Grid Array (BVB) - 6x6x0.6 mm Body [UFBGA] Atmel Legacy Global Package Code CJM

**Note:** For the most current package drawings, please see the Microchip Packaging Specification located at <http://www.microchip.com/packaging>

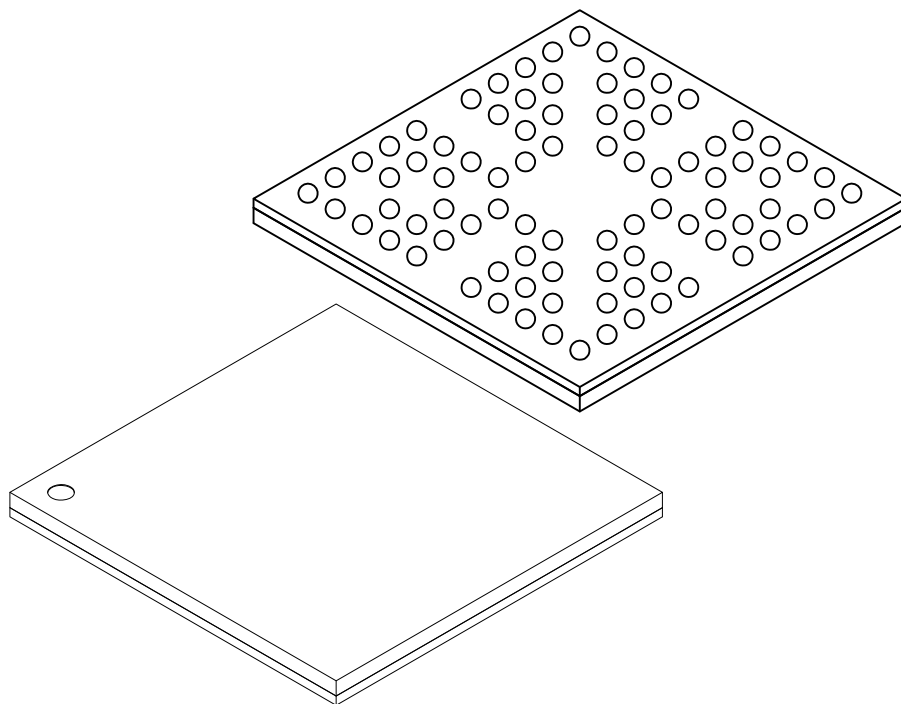

		Units	MILLIMETERS		
Dimension Limits		MIN	NOM	MAX	
Number of Terminals	N	88			
Pitch	e	0.50 BSC			
Overall Terminal Spacing	eD	5.00 BSC			
Overall Terminal Spacing	eE	5.00 BSC			
Overall Height	A	-	-	0.60	
Standoff	A1	0.11	-	0.21	
Overall Length	D	6.00 BSC			
Overall Width	E	6.00 BSC			
Terminal Diameter	b	0.22	0.25	0.28	

**Notes:**

- Pin 1 visual index feature may vary, but must be located within the hatched area.
- Dimensioning and tolerancing per ASME Y14.5M  
BSC: Basic Dimension. Theoretically exact value shown without tolerances.  
REF: Reference Dimension, usually without tolerance, for information purposes only.



**88-Ball Ultra Thin Fine Pitch Ball Grid Array (BVB) - 6x6x0.6 mm Body [UFBGA]  
Atmel Legacy Global Package Code CJM**

**Note:** For the most current package drawings, please see the Microchip Packaging Specification located at <http://www.microchip.com/packaging>

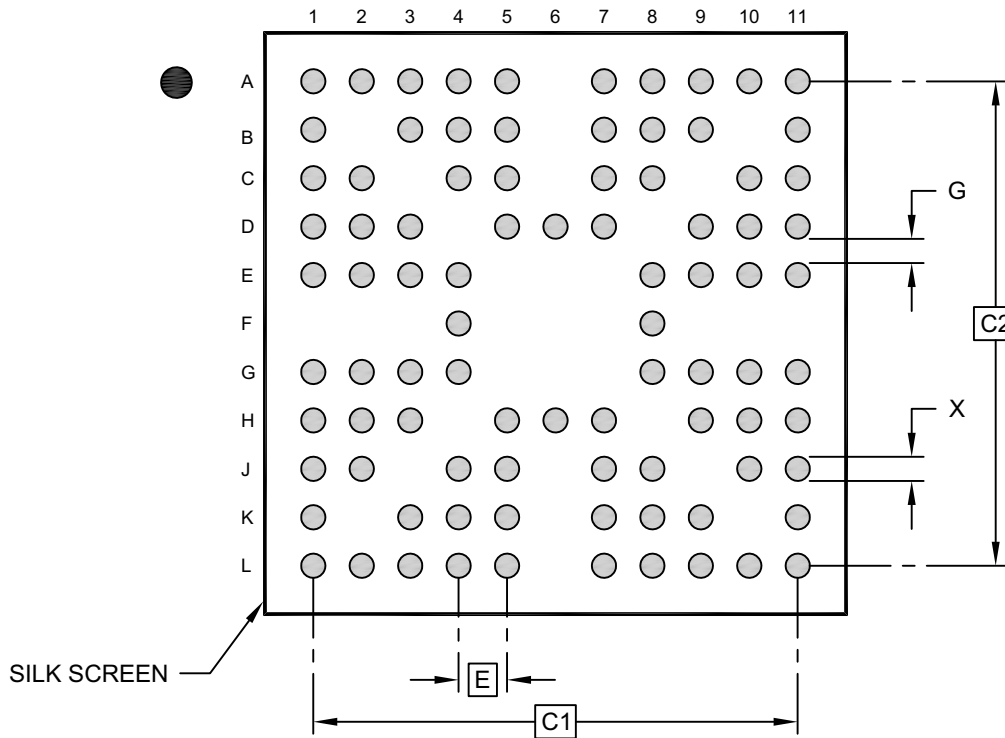

**RECOMMENDED LAND PATTERN**

Dimension Limits	Units	MILLIMETERS		
		MIN	NOM	MAX
Contact Pitch	E	0.50 BSC		
Overall Contact Pitch	C1	5.00 BSC		
Overall Contact Pitch	C2	5.00 BSC		
Contact Pad Diameter	X			0.28
Contact Pad to Contact Pad	G	0.25		

**Notes:**

1. Dimensioning and tolerancing per ASME Y14.5M  
BSC: Basic Dimension. Theoretically exact value shown without tolerances.
2. For best soldering results, thermal vias, if used, should be filled or tented to avoid solder loss during reflow process

Microchip Technology Drawing C04-23158 Rev A

## APPENDIX A: ASSOCIATED DOCUMENTS

### Microchip maXTouch Documents

The following documents are available on the Microchip website.

#### Touchscreen Design and PCB/FPCB Layout Guidelines

- Application Note: MXTAN0208 – *Design Guide for PCB Layouts for maXTouch Touch Controllers*
- Application Note: QTAN0080 – *Touchscreens Sensor Design Guide*
- Application Note: AN2683 – *Edge Wiring for Self Capacitance maXTouch Touchscreens*

#### Configuring and Tuning the Device

- Application Note: MXTAN0213 – *Interfacing with maXTouch Touchscreen Controllers*

#### Tools

- *maXTouch Studio User Guide* (accessible as on-line help from within maXTouch Studio)

### External Documents

The following documents are not supplied by Microchip. To obtain any of the following documents, please contact the relevant organization.

#### I<sup>2</sup>C Interface

- UM10204, *I<sup>2</sup>C bus specification and user manual*, Rev. 6 — 4 April 2014  
Available from NXP

#### HID/I<sup>2</sup>C Interface

- *HID Over I<sup>2</sup>C Protocol Specification – Device Side*, Version 1.00  
Available from Microsoft Corporation

**APPENDIX B: REVISION HISTORY**

**Revision A (June 2021)**

Initial edition for firmware revision 1.0.AA – Release

## INDEX

### A

Absolute maximum specifications .....	52
Adjacent key suppression technology .....	22
AKS. See <i>Adjacent key suppression</i>	
Analog I/O .....	45
Analog voltage supply .....	53
AVdd voltage supply .....	53

### C

Calibration .....	20
Capacitive Touch Engine (CTE).....	9
Charge time.....	20
Checksum in I <sup>2</sup> C writes.....	25
CHG line.....	29
HID-I <sup>2</sup> C.....	40
mode 0 operation .....	30
mode 1 operation .....	30
Clock stretching.....	31, 40
Communications .....	24
HID-I <sup>2</sup> C. See <i>HID-I<sup>2</sup>C communications</i>	
I <sup>2</sup> C mode selection .....	24
I <sup>2</sup> C. See <i>I<sup>2</sup>C communications</i>	
I2CMODE pin .....	24
Component placement and tracking .....	45
Connection Information see <i>Pinouts</i> .....	3
Customer Change Notification Service .....	71
Customer Notification Service .....	71
Customer Support .....	71

### D

DC characteristics .....	53
Debugging.....	51
Hardware Debug Interface .....	12, 51
object-based protocol.....	51
self test.....	51
Decoupling capacitors .....	11, 41
Detailed operation .....	20
Detection integrator.....	20
Device .....	
overview .....	9
Digital filtering.....	21
Digital signals .....	45
Digital voltage supply .....	53
Digitizer HID-I <sup>2</sup> C top-level collection .....	32, 38
maximum touches (surface contacts) report.....	40
touch report.....	38
Direct Memory Access .....	27
Driven shield lines .....	11, 16, 44

### E

EMC problems .....	45
EMC Reduction .....	21
ESD information .....	61

### G

Generic HID-I <sup>2</sup> C top-level collection .....	32, 33
read/write memory map command.....	33
send auto-return command.....	35
Generic key array.....	16
Glove detection .....	22
GPIO pins.....	12
Grip suppression .....	22
Ground tracking.....	41

### H

Hardware Debug Interface.....	12, 51
HID descriptor .....	
HID-I <sup>2</sup> C .....	32
HID-I <sup>2</sup> C communications .....	32-40
CHG line .....	40
clock stretching.....	40
digitizer HID-I <sup>2</sup> C. See <i>Digitizer HID-I<sup>2</sup>C top-level collection</i>	
generic HID-I <sup>2</sup> C. See <i>Generic HID-I<sup>2</sup>C top-level collection</i>	
HID descriptor.....	32
I <sup>2</sup> C mode selection .....	24
I2CMODE pin .....	24
Microsoft Windows compliance .....	40
power control .....	40
report IDs.....	32
SCL line .....	40
SDA line.....	40
specification .....	32, 60

### I

I/O pins .....	11
I <sup>2</sup> C communications.....	25-31
CHG line .....	29
clock stretching.....	31
I <sup>2</sup> C mode selection .....	24
I2CMODE pin .....	24
reading from the device .....	26
reading messages with DMA.....	27
SCL line .....	30
SDA line.....	30
specification.....	60
writes in checksum mode .....	25
writing to the device .....	25
I <sup>2</sup> C interface .....	
SCL line .....	11, 30
SDA line.....	11, 30
I2CMODE pin.....	24
Input/Output characteristics .....	59
Internet Address .....	71

### J

Junction temperature .....	60
----------------------------	----

### L

latency, touch.....	58
Lens bending .....	22

### M

Microchip Internet Web Site.....	71
Microsoft Windows compliance .....	
HID-I <sup>2</sup> C communications .....	40
Moisture sensitivity level (msl) .....	61
Multiple function pins .....	11
Mutual capacitance measurements .....	9

### N

Noise suppression .....	21
display .....	21

### O

Object-based protocol (OBP).....	46, 51
Operational modes .....	20
Overview of the mXT640UD-CCU001 .....	9

## P

PCB cleanliness .....	41
PCB design .....	41
analog I/O .....	45
component placement and tracking .....	45
decoupling capacitors .....	41
digital signals .....	45
EMC problems .....	45
ground tracking .....	41
PCB cleanliness .....	41
power supply .....	41
supply rails .....	41
voltage pump .....	41
voltage regulator .....	42
Pinouts .....	3
Power control with HID-I <sup>2</sup> C communications .....	40
Power supply	
I/O pins .....	11
PCB design .....	41
Power supply ripple and noise .....	53
Power-up procedure .....	46
Power-up/reset .....	17
power-on reset (POR) .....	17
VddIO enabled after Vdd .....	19
Pull-up resistors .....	11

## R

Reading from the Device .....	50
Recommended operating conditions .....	52
Repeatability .....	59
Report IDs	
HID-I <sup>2</sup> C communications .....	32
Report rate .....	58
Reset timings .....	59
Retransmission compensation .....	21

## S

Schematic .....	10
decoupling capacitors .....	11
GPIO pins .....	12
I <sup>2</sup> C interface .....	11
pull-up resistors .....	11
voltage pump .....	11
SCL line .....	11, 30, 40
SDA line .....	11, 30, 40
Self capacitance measurements .....	9
Self test .....	51
Sensor acquisition .....	20
Sensor layout .....	14–16
electrodes .....	14
sensors .....	14
touch panel .....	14
Shieldless support .....	21
Soldering profile .....	61
Specifications .....	52–61
absolute maximum specifications .....	52
analog voltage supply .....	53
DC characteristics .....	53

digital voltage supply .....	53
ESD information .....	61
HID-I <sup>2</sup> C specification .....	60
I <sup>2</sup> C specification .....	60
input/output characteristics .....	59
junction temperature .....	60
moisture sensitivity level (msl) .....	61
power supply ripple and noise .....	53
recommended operating conditions .....	52
repeatability .....	59
reset timings .....	59
soldering profile .....	61
test configuration .....	54
thermal data .....	60
timing specifications .....	58
touch accuracy .....	59
touchscreen sensor characteristics .....	59
XVdd voltage supply .....	53
Start-up procedure .....	46
Stylus support .....	22
Supply rails .....	41
SYNC pin .....	11

## T

TCL. See <i>Top-level collection</i>	
Test configuration specification .....	54
Thermal data .....	60
Timing specifications .....	58
report rate .....	58
touch latency .....	58
Top-level collection .....	32
digitizer HID-I <sup>2</sup> C. See <i>Digitizer HID-I<sup>2</sup>C top-level collection</i>	
generic HID-I <sup>2</sup> C. See <i>Generic HID-I<sup>2</sup>C top-level collection</i>	33
Touch accuracy .....	59
Touch detection .....	9, 20
Touch latency .....	58
Touchscreen sensor characteristics .....	59
Touchscreen Size size .....	15
Tuning .....	51

## U

Unintentional touch suppression .....	22
---------------------------------------	----

## V

Vdd voltage supply .....	53
VddCore supply .....	11
VddIO voltage supply .....	53
Voltage pump .....	11, 41
Voltage regulator .....	42
multiple supply operation .....	43
single supply operation .....	43

## W

Writing to the Device .....	49
WWW Address .....	71

## X

XVdd voltage supply .....	53
---------------------------	----

# mXT640UD-CCU001 1.0

## PRODUCT IDENTIFICATION SYSTEM

The table below gives details on the product identification system for maXTouch devices. See [“Orderable Part Numbers”](#) below for example part numbers for the mXT640UD-CCU001.

To order or obtain information, for example on pricing or delivery, refer to the factory or the listed sales office.

PART NO.	-XXX	[X]	[X]	[XXX]
Device	Package	Temperature Range	Tape and Reel Option	Pattern
Device:	Base device name			
Package:	CC	=	UFBGA (Ultra Thin Fine-pitch Ball Grid Array)	
	C2	=	UFBGA (Ultra Thin Fine-pitch Ball Grid Array)	
	NH	=	UFBGA (Ultra Thin Fine-pitch Ball Grid Array)	
	C4	=	X1FBGA (Extra Thin Fine-pitch Ball Grid Array)	
	MA	=	XQFN (Super Thin Quad Flat No Lead Sawn)	
	MA5	=	XQFN (Super Thin Quad Flat No Lead Sawn)	
Temperature Range:	U	=	-40°C to +85°C (Grade 3)	
	T	=	-40°C to +85°C (Grade 3)	
	B	=	-40°C to +105°C (Grade 2)	
Tape and Reel Option:	<i>Blank</i>	=	Standard Packaging (Tube or Tray)	
	R	=	Tape and Reel <sup>(1)</sup>	
Pattern:	Extension, QTP, SQTP, Code or Special Requirements (Blank Otherwise)			

**Note 1:** Tape and Reel identifier only appears in the catalog part number description. This identifier is used for ordering purposes and is not printed on the device package. See [“Orderable Part Numbers”](#) below or check with your Microchip Sales Office for package availability with the Tape and Reel option.

## Orderable Part Numbers

Orderable Part Number	Firmware Revision	Description
ATMXT640UD-CCU001 (Supplied in trays)	1.0.AA	88-ball UFBGA 6 × 6 × 0.6 mm, RoHS compliant Industrial grade; not suitable for automotive characterization
ATMXT640UD-CCUR001 (Supplied in tape and reel)		

## THE MICROCHIP WEB SITE

Microchip provides online support via our WWW site at [www.microchip.com](http://www.microchip.com). This web site is used as a means to make files and information easily available to customers. Accessible by using your favorite Internet browser, the web site contains the following information:

- **Product Support** – Datasheets and errata, application notes and sample programs, design resources, user's guides and hardware support documents, latest software releases and archived software
- **General Technical Support** – Frequently Asked Questions (FAQ), technical support requests, online discussion groups, Microchip consultant program member listing
- **Business of Microchip** – Product selector and ordering guides, latest Microchip press releases, listing of seminars and events, listings of Microchip sales offices, distributors and factory representatives

## THE MAXTOUCH WEB SITE

Information on Microchip's maXTouch product line can be accessed via the microchip web site at [www.microchip.com](http://www.microchip.com), This information is also available for direct access via a short-cut at [www.maxtouch.com](http://www.maxtouch.com). The maXTouch web pages contain the following information:

- **Product Information** – Product specifications, brochures, datasheets, protocol guides
- **Tools and Software** – Evaluation kits, maXTouch Studio, software libraries for individual maXTouch touch controllers
- **Training and Support** – Generic application notes and training material for the maXTouch product range

## CUSTOMER CHANGE NOTIFICATION SERVICE

Microchip's customer notification service helps keep customers current on Microchip products. Subscribers will receive e-mail notification whenever there are changes, updates, revisions or errata related to a specified product family or development tool of interest.

To register, access the Microchip web site at [www.microchip.com](http://www.microchip.com). Under "Support", click on "Customer Change Notification" and follow the registration instructions.

## CUSTOMER SUPPORT

Users of Microchip products can receive assistance through several channels:

- Distributor or Representative
- Local Sales Office
- Field Application Engineer (FAE)
- Technical Support

Customers should contact their distributor, representative or Field Application Engineer (FAE) for support. Local sales offices are also available to help customers. A listing of sales offices and locations is included in the back of this document.

Technical support is available through the web site at: <http://microchip.com/support>

NOTES:



---

---

**Note the following details of the code protection feature on Microchip devices:**

- Microchip products meet the specifications contained in their particular Microchip Data Sheet.
- Microchip believes that its family of products is secure when used in the intended manner and under normal conditions.
- There are dishonest and possibly illegal methods being used in attempts to breach the code protection features of the Microchip devices. We believe that these methods require using the Microchip products in a manner outside the operating specifications contained in Microchip's Data Sheets. Attempts to breach these code protection features, most likely, cannot be accomplished without violating Microchip's intellectual property rights.
- Microchip is willing to work with any customer who is concerned about the integrity of its code.
- Neither Microchip nor any other semiconductor manufacturer can guarantee the security of its code. Code protection does not mean that we are guaranteeing the product is "unbreakable." Code protection is constantly evolving. We at Microchip are committed to continuously improving the code protection features of our products. Attempts to break Microchip's code protection feature may be a violation of the Digital Millennium Copyright Act. If such acts allow unauthorized access to your software or other copyrighted work, you may have a right to sue for relief under that Act.

---

Information contained in this publication is provided for the sole purpose of designing with and using Microchip products. Information regarding device applications and the like is provided only for your convenience and may be superseded by updates. It is your responsibility to ensure that your application meets with your specifications.

THIS INFORMATION IS PROVIDED BY MICROCHIP "AS IS". MICROCHIP MAKES NO REPRESENTATIONS OR WARRANTIES OF ANY KIND WHETHER EXPRESS OR IMPLIED, WRITTEN OR ORAL, STATUTORY OR OTHERWISE, RELATED TO THE INFORMATION INCLUDING BUT NOT LIMITED TO ANY IMPLIED WARRANTIES OF NON-INFRINGEMENT, MERCHANTABILITY, AND FITNESS FOR A PARTICULAR PURPOSE OR WARRANTIES RELATED TO ITS CONDITION, QUALITY, OR PERFORMANCE.

IN NO EVENT WILL MICROCHIP BE LIABLE FOR ANY INDIRECT, SPECIAL, PUNITIVE, INCIDENTAL OR CONSEQUENTIAL LOSS, DAMAGE, COST OR EXPENSE OF ANY KIND WHATSOEVER RELATED TO THE INFORMATION OR ITS USE, HOWEVER CAUSED, EVEN IF MICROCHIP HAS BEEN ADVISED OF THE POSSIBILITY OR THE DAMAGES ARE FORESEEABLE. TO THE FULLEST EXTENT ALLOWED BY LAW, MICROCHIP'S TOTAL LIABILITY ON ALL CLAIMS IN ANY WAY RELATED TO THE INFORMATION OR ITS USE WILL NOT EXCEED THE AMOUNT OF FEES, IF ANY, THAT YOU HAVE PAID DIRECTLY TO MICROCHIP FOR THE INFORMATION. Use of Microchip devices in life support and/or safety applications is entirely at the buyer's risk, and the buyer agrees to defend, indemnify and hold harmless Microchip from any and all damages, claims, suits, or expenses resulting from such use. No licenses are conveyed, implicitly or otherwise, under any Microchip intellectual property rights unless otherwise stated.

#### Trademarks

The Microchip name and logo, the Microchip logo, Adaptec, AnyRate, AVR, AVR logo, AVR Freaks, BesTime, BitCloud, chipKIT, chipKIT logo, CryptoMemory, CryptoRF, dsPIC, FlashFlex, flexPWR, HELDO, IGLOO, JukeBlox, KeeLoq, Kleer, LANCheck, LinkMD, maXStylus, maXTouch, MediaLB, megaAVR, Microsemi, Microsemi logo, MOST, MOST logo, MPLAB, OptoLyzer, PackeTime, PIC, picoPower, PICSTART, PIC32 logo, PolarFire, Prochip Designer, QTouch, SAM-BA, SenGenuity, SpyNIC, SST, SST Logo, SuperFlash, Symmetricom, SyncServer, Tachyon, TimeSource, tinyAVR, UNI/O, Vectron, and XMEGA are registered trademarks of Microchip Technology Incorporated in the U.S.A. and other countries.

AgileSwitch, APT, ClockWorks, The Embedded Control Solutions Company, EtherSynch, FlashTec, Hyper Speed Control, HyperLight Load, IntelliMOS, Libero, motorBench, mTouch, Powermite 3, Precision Edge, ProASIC, ProASIC Plus, ProASIC Plus logo, Quiet-Wire, SmartFusion, SyncWorld, Temux, TimeCesium, TimeHub, TimePictra, TimeProvider, WinPath, and ZL are registered trademarks of Microchip Technology Incorporated in the U.S.A.

Adjacent Key Suppression, AKS, Analog-for-the-Digital Age, Any Capacitor, AnyIn, AnyOut, Augmented Switching, BlueSky, BodyCom, CodeGuard, CryptoAuthentication, CryptoAutomotive, CryptoCompanion, CryptoController, dsPICDEM, dsPICDEM.net, Dynamic Average Matching, DAM, ECAN, Espresso T1S, EtherGREEN, IdealBridge, In-Circuit Serial Programming, ICSP, INICnet, Intelligent Paralleling, Inter-Chip Connectivity, JitterBlocker, maxCrypto, maxView, memBrain, Mindi, MiWi, MPASM, MPF, MPLAB Certified logo, MPLIB, MPLINK, MultiTRAK, NetDetach, Omniscient Code Generation, PICDEM, PICDEM.net, PICkit, PICtail, PowerSmart, PureSilicon, QMatrix, REAL ICE, Ripple Blocker, RTAX, RTG4, SAM-ICE, Serial Quad I/O, simpleMAP, SimpliPHY, SmartBuffer, SMART-I.S., storClad, SQL, SuperSwitcher, SuperSwitcher II, Switchtec, SynchroPHY, Total Endurance, TSHARC, USBCheck, VariSense, VectorBlox, VeriPHY, ViewSpan, WiperLock, XpressConnect, and ZENA are trademarks of Microchip Technology Incorporated in the U.S.A. and other countries.

SQTP is a service mark of Microchip Technology Incorporated in the U.S.A.

The Adaptec logo, Frequency on Demand, Silicon Storage Technology, and Symmcom are registered trademarks of Microchip Technology Inc. in other countries.

GestIC is a registered trademark of Microchip Technology Germany II GmbH & Co. KG, a subsidiary of Microchip Technology Inc., in other countries.

All other trademarks mentioned herein are property of their respective companies.

© 2021, Microchip Technology Incorporated, All Rights Reserved.

ISBN: 978-1-5224-8455-4

For information regarding Microchip's Quality Management Systems, please visit [www.microchip.com/quality](http://www.microchip.com/quality).

---

---

## Worldwide Sales and Service

---

---

### AMERICAS

**Corporate Office**  
2355 West Chandler Blvd.  
Chandler, AZ 85224-6199  
Tel: 480-792-7200  
Fax: 480-792-7277  
Technical Support:  
[http://www.microchip.com/  
support](http://www.microchip.com/support)  
Web Address:  
[www.microchip.com](http://www.microchip.com)

#### Atlanta

Duluth, GA  
Tel: 678-957-9614  
Fax: 678-957-1455

#### Austin, TX

Tel: 512-257-3370

#### Boston

Westborough, MA  
Tel: 774-760-0087  
Fax: 774-760-0088

#### Chicago

Itasca, IL  
Tel: 630-285-0071  
Fax: 630-285-0075

#### Dallas

Addison, TX  
Tel: 972-818-7423  
Fax: 972-818-2924

#### Detroit

Novi, MI  
Tel: 248-848-4000

#### Houston, TX

Tel: 281-894-5983

#### Indianapolis

Noblesville, IN  
Tel: 317-773-8323  
Fax: 317-773-5453  
Tel: 317-536-2380

#### Los Angeles

Mission Viejo, CA  
Tel: 949-462-9523  
Fax: 949-462-9608  
Tel: 951-273-7800

#### Raleigh, NC

Tel: 919-844-7510

#### New York, NY

Tel: 631-435-6000

#### San Jose, CA

Tel: 408-735-9110  
Tel: 408-436-4270

#### Canada - Toronto

Tel: 905-695-1980  
Fax: 905-695-2078

### ASIA/PACIFIC

**Australia - Sydney**  
Tel: 61-2-9868-6733

**China - Beijing**  
Tel: 86-10-8569-7000

**China - Chengdu**  
Tel: 86-28-8665-5511

**China - Chongqing**  
Tel: 86-23-8980-9588

**China - Dongguan**  
Tel: 86-769-8702-9880

**China - Guangzhou**  
Tel: 86-20-8755-8029

**China - Hangzhou**  
Tel: 86-571-8792-8115

**China - Hong Kong SAR**  
Tel: 852-2943-5100

**China - Nanjing**  
Tel: 86-25-8473-2460

**China - Qingdao**  
Tel: 86-532-8502-7355

**China - Shanghai**  
Tel: 86-21-3326-8000

**China - Shenyang**  
Tel: 86-24-2334-2829

**China - Shenzhen**  
Tel: 86-755-8864-2200

**China - Suzhou**  
Tel: 86-186-6233-1526

**China - Wuhan**  
Tel: 86-27-5980-5300

**China - Xian**  
Tel: 86-29-8833-7252

**China - Xiamen**  
Tel: 86-592-2388138

**China - Zhuhai**  
Tel: 86-756-3210040

### ASIA/PACIFIC

**India - Bangalore**  
Tel: 91-80-3090-4444

**India - New Delhi**  
Tel: 91-11-4160-8631

**India - Pune**  
Tel: 91-20-4121-0141

**Japan - Osaka**  
Tel: 81-6-6152-7160

**Japan - Tokyo**  
Tel: 81-3-6880-3770

**Korea - Daegu**  
Tel: 82-53-744-4301

**Korea - Seoul**  
Tel: 82-2-554-7200

**Malaysia - Kuala Lumpur**  
Tel: 60-3-7651-7906

**Malaysia - Penang**  
Tel: 60-4-227-8870

**Philippines - Manila**  
Tel: 63-2-634-9065

**Singapore**  
Tel: 65-6334-8870

**Taiwan - Hsin Chu**  
Tel: 886-3-577-8366

**Taiwan - Kaohsiung**  
Tel: 886-7-213-7830

**Taiwan - Taipei**  
Tel: 886-2-2508-8600

**Thailand - Bangkok**  
Tel: 66-2-694-1351

**Vietnam - Ho Chi Minh**  
Tel: 84-28-5448-2100

### EUROPE

**Austria - Wels**  
Tel: 43-7242-2244-39  
Fax: 43-7242-2244-393

**Denmark - Copenhagen**  
Tel: 45-4485-5910  
Fax: 45-4485-2829

**Finland - Espoo**  
Tel: 358-9-4520-820

**France - Paris**  
Tel: 33-1-69-53-63-20  
Fax: 33-1-69-30-90-79

**Germany - Garching**  
Tel: 49-8931-9700

**Germany - Haan**  
Tel: 49-2129-3766400

**Germany - Heilbronn**  
Tel: 49-7131-72400

**Germany - Karlsruhe**  
Tel: 49-721-625370

**Germany - Munich**  
Tel: 49-89-627-144-0  
Fax: 49-89-627-144-44

**Germany - Rosenheim**  
Tel: 49-8031-354-560

**Israel - Ra'anana**  
Tel: 972-9-744-7705

**Italy - Milan**  
Tel: 39-0331-742611  
Fax: 39-0331-466781

**Italy - Padova**  
Tel: 39-049-7625286

**Netherlands - Drunen**  
Tel: 31-416-690399  
Fax: 31-416-690340

**Norway - Trondheim**  
Tel: 47-7288-4388

**Poland - Warsaw**  
Tel: 48-22-3325737

**Romania - Bucharest**  
Tel: 40-21-407-87-50

**Spain - Madrid**  
Tel: 34-91-708-08-90  
Fax: 34-91-708-08-91

**Sweden - Gothenberg**  
Tel: 46-31-704-60-40

**Sweden - Stockholm**  
Tel: 46-8-5090-4654

**UK - Wokingham**  
Tel: 44-118-921-5800  
Fax: 44-118-921-5820