

REVISIONS

P	LTR	DESCRIPTION	DATE	DWN	APVD
	A	NEW DRAWING	01JUL2022	KS	AP

NOTES:

1. PCB WITH A COPPER THICKNESS OF TWO OUNCES SHOULD BE USED.
2. FOR FURTHER INFORMATION SEE DATA SHEET FOR 3503 SERIES ALUMINUM NITRIDE THIN FILM POWER RESISTORS.

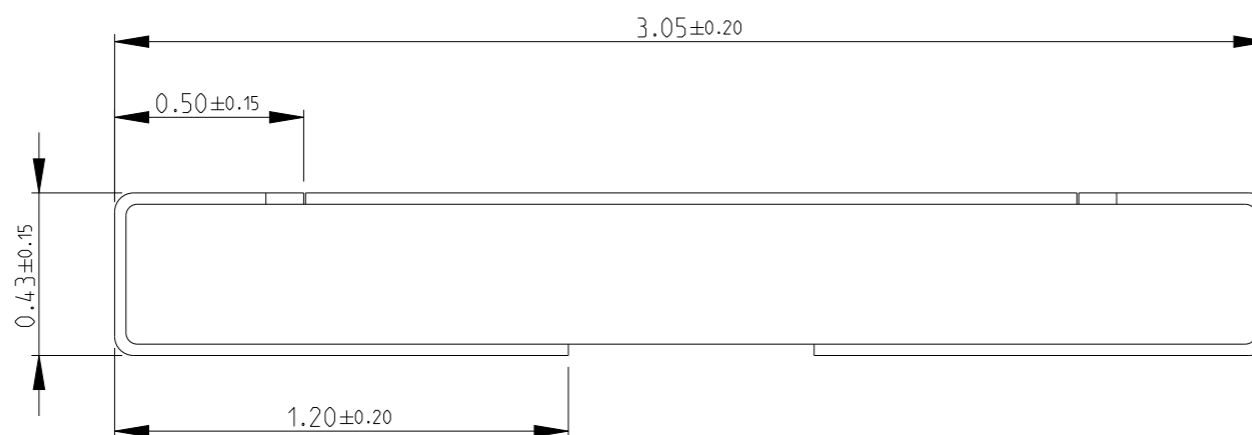
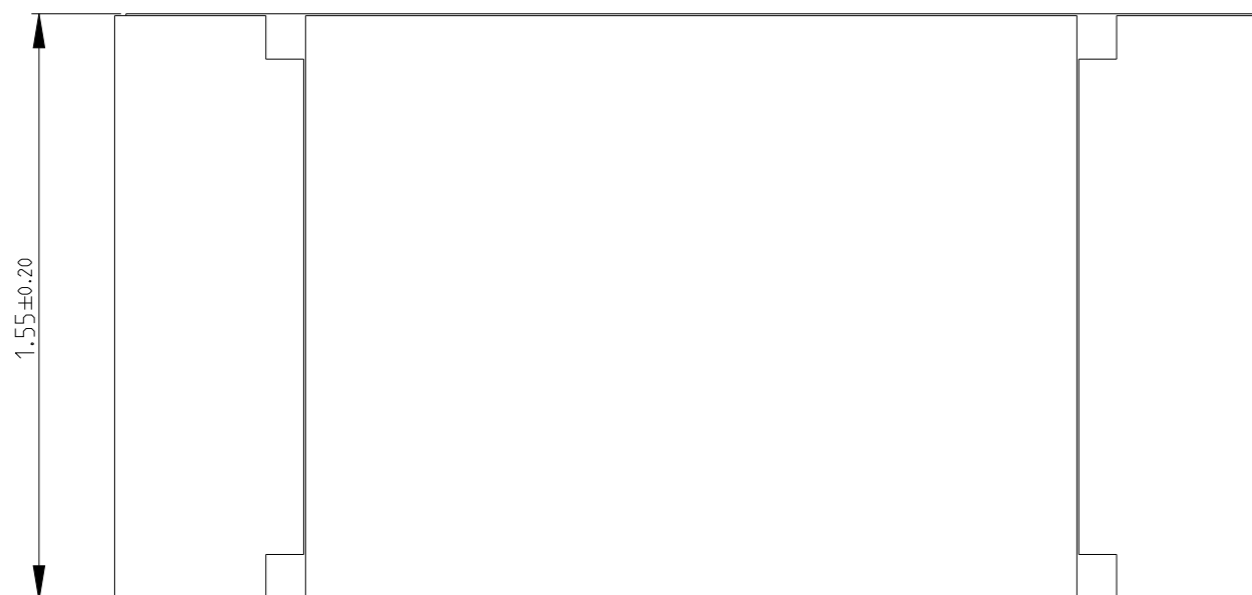

RoHS Compliant

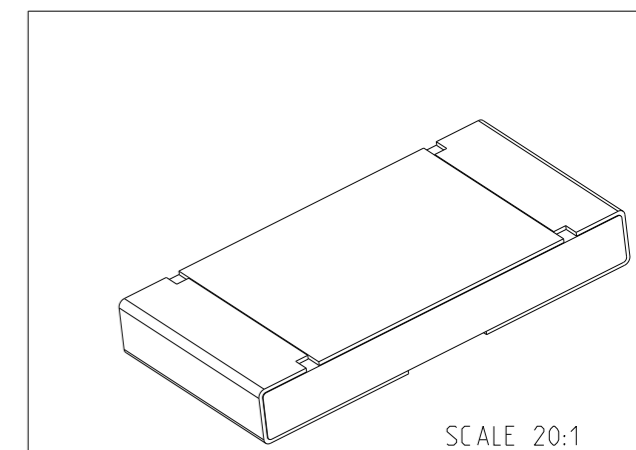

RECOMMENDED LAND PATTERN

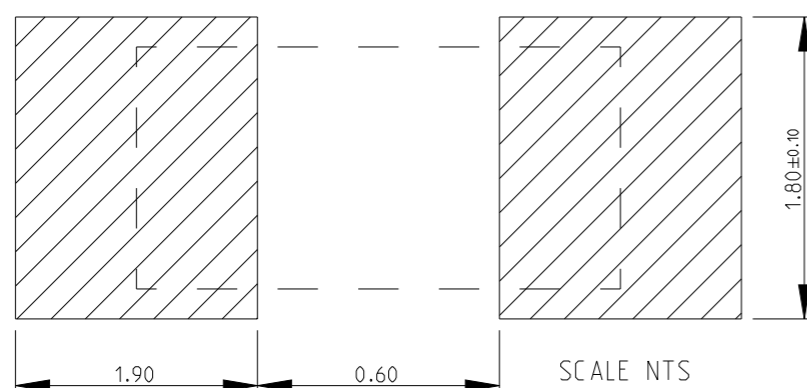

THIS DRAWING IS A CONTROLLED DOCUMENT.		DWN KARTHIK. S 01JUL2022	<p>TE Connectivity</p> <p>ALUMINIUM NITRIDE THIN FILM POWER RESISTOR TYPE 3503 SERIES</p>				
DIMENSIONS: mm		CHK ALLAN. P 01JUL2022				NAME	RESTRICTED TO
TOLERANCES UNLESS OTHERWISE SPECIFIED:		APVD ALLAN. P 01JUL2022				SIZE	CAGE CODE
0 PLC ±0.5 1 PLC ±0.2 2 PLC ±0.1 3 PLC ± 4 PLC ± ANGLES ±5°		PRODUCT SPEC				DRAWING NO	REVISION
MATERIAL		APPLICATION SPEC	WEIGHT	SCALE	SHEET		
-		-	-	A3 00779	1 OF 3		
-		FINISH	-	C=2176527	REV A		
-		WEIGHT	-	CUSTOMER DRAWING	SCALE 50:1		

REVISIONS

P	LTR	DESCRIPTION	DATE	DWN	APVD
	-	SEE SHEET 1	-	-	-

SCHEDULE

TCPN	CATALOGUE NUMBER	PART DESCRIPTION	PART STATUS
2176527-1	3503G2B549RFTD	3503G 2B 549R 1% 5K RL	PRODUCTION
2176527-2	3503G2B562RFTD	3503G 2B 562R 1% 5K RL	PRODUCTION
2176527-3	3503G2B576RFTD	3503G 2B 576R 1% 5K RL	PRODUCTION
2176527-4	3503G2B590RFTD	3503G 2B 590R 1% 5K RL	PRODUCTION
2176527-5	3503G2B604RFTD	3503G 2B 604R 1% 5K RL	PRODUCTION
2176527-6	3503G2B619RFTD	3503G 2B 619R 1% 5K RL	PRODUCTION
2176527-7	3503G2B634RFTD	3503G 2B 634R 1% 5K RL	PRODUCTION
2176527-8	3503G2B649RFTD	3503G 2B 649R 1% 5K RL	PRODUCTION
2176527-9	3503G2B665RFTD	3503G 2B 665R 1% 5K RL	PRODUCTION
1-2176527-0	3503G2B681RFTD	3503G 2B 681R 1% 5K RL	PRODUCTION
1-2176527-1	3503G2B698RFTD	3503G 2B 698R 1% 5K RL	PRODUCTION
1-2176527-2	3503G2B715RFTD	3503G 2B 715R 1% 5K RL	PRODUCTION
1-2176527-3	3503G2B732RFTD	3503G 2B 732R 1% 5K RL	PRODUCTION
1-2176527-4	3503G2B750RFTD	3503G 2B 750R 1% 5K RL	PRODUCTION
1-2176527-5	3503G2B768RFTD	3503G 2B 768R 1% 5K RL	PRODUCTION
1-2176527-6	3503G2B787RFTD	3503G 2B 787R 1% 5K RL	PRODUCTION
1-2176527-7	3503G2B806RFTD	3503G 2B 806R 1% 5K RL	PRODUCTION
1-2176527-8	3503G2B825RFTD	3503G 2B 825R 1% 5K RL	PRODUCTION
1-2176527-9	3503G2B845RFTD	3503G 2B 845R 1% 5K RL	PRODUCTION
2-2176527-0	3503G2B866RFTD	3503G 2B 866R 1% 5K RL	PRODUCTION
2-2176527-1	3503G2B887RFTD	3503G 2B 887R 1% 5K RL	PRODUCTION
2-2176527-2	3503G2B909RFTD	3503G 2B 909R 1% 5K RL	PRODUCTION
2-2176527-3	3503G2B931RFTD	3503G 2B 931R 1% 5K RL	PRODUCTION
2-2176527-4	3503G2B953RFTD	3503G 2B 953R 1% 5K RL	PRODUCTION
2-2176527-5	3503G2B976RFTD	3503G 2B 976R 1% 5K RL	PRODUCTION
2-2176527-6	3503G2B1K0FTD	3503G 2B 1K0 1% 5K RL	PRODUCTION
2-2176527-7	3503G2B1K02FTD	3503G 2B 1K02 1% 5K RL	PRODUCTION
2-2176527-8	3503G2B1K05FTD	3503G 2B 1K05 1% 5K RL	PRODUCTION
2-2176527-9	3503G2B1K07FTD	3503G 2B 1K07 1% 5K RL	PRODUCTION
3-2176527-0	3503G2B1K1FTD	3503G 2B 1K1 1% 5K RL	PRODUCTION

SCHEDULE

TCPN	CATALOGUE NUMBER	PART DESCRIPTION	PART STATUS
3-2176527-1	3503G2B1K13FTD	3503G 2B 1K13 1% 5K RL	PRODUCTION
3-2176527-2	3503G2B1K15FTD	3503G 2B 1K15 1% 5K RL	PRODUCTION
3-2176527-3	3503G2B1K18FTD	3503G 2B 1K18 1% 5K RL	PRODUCTION
3-2176527-4	3503G2B1K21FTD	3503G 2B 1K21 1% 5K RL	PRODUCTION
3-2176527-5	3503G2B1K24FTD	3503G 2B 1K24 1% 5K RL	PRODUCTION
3-2176527-6	3503G2B1K27FTD	3503G 2B 1K27 1% 5K RL	PRODUCTION
3-2176527-7	3503G2B1K3FTD	3503G 2B 1K3 1% 5K RL	PRODUCTION
3-2176527-8	3503G2B1K33FTD	3503G 2B 1K33 1% 5K RL	PRODUCTION
3-2176527-9	3503G2B1K37FTD	3503G 2B 1K37 1% 5K RL	PRODUCTION
4-2176527-0	3503G2B1K4FTD	3503G 2B 1K4 1% 5K RL	PRODUCTION
4-2176527-1	3503G2B1K43FTD	3503G 2B 1K43 1% 5K RL	PRODUCTION
4-2176527-2	3503G2B1K47FTD	3503G 2B 1K47 1% 5K RL	PRODUCTION
4-2176527-3	3503G2B1K5FTD	3503G 2B 1K5 1% 5K RL	PRODUCTION
4-2176527-4	3503G2B1K54FTD	3503G 2B 1K54 1% 5K RL	PRODUCTION
4-2176527-5	3503G2B1K58FTD	3503G 2B 1K58 1% 5K RL	PRODUCTION
4-2176527-6	3503G2B1K62FTD	3503G 2B 1K62 1% 5K RL	PRODUCTION
4-2176527-7	3503G2B1K65FTD	3503G 2B 1K65 1% 5K RL	PRODUCTION
4-2176527-8	3503G2B1K69FTD	3503G 2B 1K69 1% 5K RL	PRODUCTION
4-2176527-9	3503G2B1K74FTD	3503G 2B 1K74 1% 5K RL	PRODUCTION
5-2176527-0	3503G2B1K78FTD	3503G 2B 1K78 1% 5K RL	PRODUCTION
5-2176527-1	3503G2B1K82FTD	3503G 2B 1K82 1% 5K RL	PRODUCTION
5-2176527-2	3503G2B1K87FTD	3503G 2B 1K87 1% 5K RL	PRODUCTION
5-2176527-3	3503G2B1K91FTD	3503G 2B 1K91 1% 5K RL	PRODUCTION
5-2176527-4	3503G2B1K96FTD	3503G 2B 1K96 1% 5K RL	PRODUCTION
5-2176527-5	3503G2B2K0FTD	3503G 2B 2K0 1% 5K RL	PRODUCTION
5-2176527-6	3503G2B2K05FTD	3503G 2B 2K05 1% 5K RL	PRODUCTION
5-2176527-7	3503G2B2K1FTD	3503G 2B 2K1 1% 5K RL	PRODUCTION
5-2176527-8	3503G2B2K15FTD	3503G 2B 2K15 1% 5K RL	PRODUCTION
5-2176527-9	3503G2B2K21FTD	3503G 2B 2K21 1% 5K RL	PRODUCTION
6-2176527-0	3503G2B2K26FTD	3503G 2B 2K26 1% 5K RL	PRODUCTION

THIS DRAWING IS A CONTROLLED DOCUMENT.

DIMENSIONS:
mm

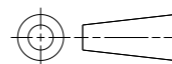

TOLERANCES UNLESS OTHERWISE SPECIFIED:

0 PLC	±0.5
1 PLC	±0.2
2 PLC	±0.1
3 PLC	±
4 PLC	±
ANGLES	±5°
FINISH	-

MATERIAL
-

DWN KARTHIK. S 01JUL2022

CHK ALLAN. P 01JUL2022

APVD ALLAN. P 01JUL2022

PRODUCT SPEC

APPLICATION SPEC

WEIGHT

CUSTOMER DRAWING



TE Connectivity

NAME ALUMINIUM NITRIDE THIN FILM POWER RESISTOR TYPE 3503 SERIES

SIZE CAGE CODE DRAWING NO RESTRICTED TO

A3 00779 C-2176527

SCALE 50:1 SHEET 2 OF 3 REV A

REVISIONS

SCHEDULE			
TCPN	CATALOGUE NUMBER	PART DESCRIPTION	PART STATUS
6-2176527-1	3503G2B2K32FTD	3503G 2B 2K32 1% 5K RL	PRODUCTION
6-2176527-2	3503G2B2K37FTD	3503G 2B 2K37 1% 5K RL	PRODUCTION
6-2176527-3	3503G2B2K43FTD	3503G 2B 2K43 1% 5K RL	PRODUCTION
6-2176527-4	3503G2B2K49FTD	3503G 2B 2K49 1% 5K RL	PRODUCTION
6-2176527-5	3503G2B2K55FTD	3503G 2B 2K55 1% 5K RL	PRODUCTION
6-2176527-6	3503G2B2K61FTD	3503G 2B 2K61 1% 5K RL	PRODUCTION
6-2176527-7	3503G2B2K67FTD	3503G 2B 2K67 1% 5K RL	PRODUCTION
6-2176527-8	3503G2B2K74FTD	3503G 2B 2K74 1% 5K RL	PRODUCTION
6-2176527-9	3503G2B2K8FTD	3503G 2B 2K8 1% 5K RL	PRODUCTION
7-2176527-0	3503G2B2K87FTD	3503G 2B 2K87 1% 5K RL	PRODUCTION
7-2176527-1	3503G2B2K94FTD	3503G 2B 2K94 1% 5K RL	PRODUCTION
7-2176527-2	3503G2B3K01FTD	3503G 2B 3K01 1% 5K RL	PRODUCTION
7-2176527-3	3503G2B3K09FTD	3503G 2B 3K09 1% 5K RL	PRODUCTION
7-2176527-4	3503G2B3K16FTD	3503G 2B 3K16 1% 5K RL	PRODUCTION
7-2176527-5	3503G2B3K24FTD	3503G 2B 3K24 1% 5K RL	PRODUCTION
7-2176527-6	3503G2B3K32FTD	3503G 2B 3K32 1% 5K RL	PRODUCTION
7-2176527-7	3503G2B3K4FTD	3503G 2B 3K4 1% 5K RL	PRODUCTION
7-2176527-8	3503G2B3K48FTD	3503G 2B 3K48 1% 5K RL	PRODUCTION
7-2176527-9	3503G2B3K57FTD	3503G 2B 3K57 1% 5K RL	PRODUCTION
8-2176527-0	3503G2B3K65FTD	3503G 2B 3K65 1% 5K RL	PRODUCTION
8-2176527-1	3503G2B3K74FTD	3503G 2B 3K74 1% 5K RL	PRODUCTION
8-2176527-2	3503G2B3K83FTD	3503G 2B 3K83 1% 5K RL	PRODUCTION
8-2176527-3	3503G2B3K92FTD	3503G 2B 3K92 1% 5K RL	PRODUCTION
8-2176527-4	3503G2B4K02FTD	3503G 2B 4K02 1% 5K RL	PRODUCTION
8-2176527-5	3503G2B4K12FTD	3503G 2B 4K12 1% 5K RL	PRODUCTION
8-2176527-6	3503G2B4K22FTD	3503G 2B 4K22 1% 5K RL	PRODUCTION
8-2176527-7	3503G2B4K32FTD	3503G 2B 4K32 1% 5K RL	PRODUCTION
8-2176527-8	3503G2B4K42FTD	3503G 2B 4K42 1% 5K RL	PRODUCTION
8-2176527-9	3503G2B4K53FTD	3503G 2B 4K53 1% 5K RL	PRODUCTION
9-2176527-0	3503G2B4K64FTD	3503G 2B 4K64 1% 5K RL	PRODUCTION
9-2176527-1	3503G2B4K75FTD	3503G 2B 4K75 1% 5K RL	PRODUCTION
9-2176527-2	3503G2B4K87FTD	3503G 2B 4K87 1% 5K RL	PRODUCTION
9-2176527-3	3503G2B4K99FTD	3503G 2B 4K99 1% 5K RL	PRODUCTION
9-2176527-4	3503G2B5K11FTD	3503G 2B 5K11 1% 5K RL	PRODUCTION
9-2176527-5	3503G2B5K23FTD	3503G 2B 5K23 1% 5K RL	PRODUCTION
9-2176527-6	3503G2B5K36FTD	3503G 2B 5K36 1% 5K RL	PRODUCTION
9-2176527-7	3503G2B5K49FTD	3503G 2B 5K49 1% 5K RL	PRODUCTION
9-2176527-8	3503G2B5K62FTD	3503G 2B 5K62 1% 5K RL	PRODUCTION
9-2176527-9	3503G2B5K76FTD	3503G 2B 5K76 1% 5K RL	PRODUCTION

P	LTR	DESCRIPTION	DATE	DWN	APVD
	-	SEE SHEET 1	-	-	-

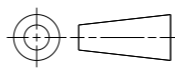
THIS DRAWING IS A CONTROLLED DOCUMENT.		DWN KARTHIK. S 01JUL2022	 TE Connectivity NAME ALUMINIUM NITRIDE THIN FILM POWER RESISTOR TYPE 3503 SERIES		
DIMENSIONS: mm		CHK ALLAN. P 01JUL2022			
		APVD ALLAN. P 01JUL2022			
TOLERANCES UNLESS OTHERWISE SPECIFIED:		PRODUCT SPEC	RESTRICTED TO		
0 PLC ±0.5 1 PLC ±0.2 2 PLC ±0.1 3 PLC ± 4 PLC ±- ANGLES ±5°		APPLICATION SPEC	SIZE	CAGE CODE	DRAWING NO
MATERIAL		WEIGHT	A3	00779	©=2176527
-		-	CUSTOMER DRAWING		
-		-	SCALE	SHEET	REV
			50:1	3 OF 3	A