

### ● Features:

1. Chip material: AlGaInP/GaAs (Red)  
and AlGaInP/GaAs (Green)
2. Emitted color : Red and Green
3. Lens Appearance : White Diffused
4. Low power consumption.
5. High efficiency.
6. Versatile mounting on P.C. Board or panel.
7. Low current requirement.
8. 3mm diameter package.
9. This product don't contained restriction substance, compliance ROHS standard.

### ● Applications:

1. TV set
2. Monitor
3. Telephone
4. Computer
5. Circuit board

### ● Package dimensions

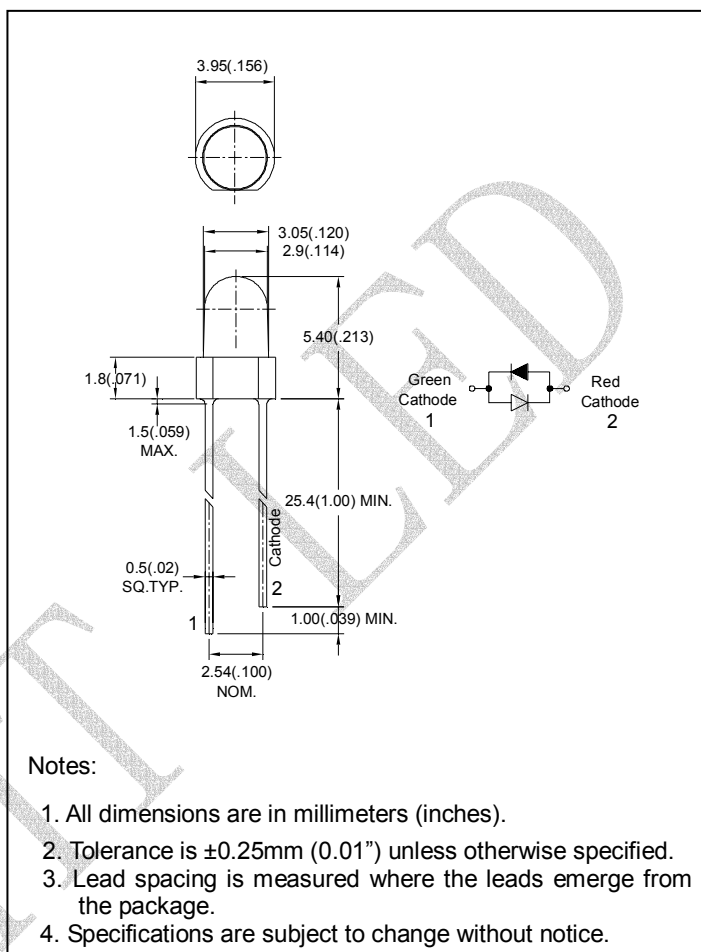

### ● Absolute Maximum Ratings(Ta=25°C)

| Parameter                          | Symbol          | Red        | Green | Unit |
|------------------------------------|-----------------|------------|-------|------|
| Power Dissipation                  | Pd              | 80         | 80    | mW   |
| Forward Current                    | I <sub>F</sub>  | 30         | 30    | mA   |
| Peak Forward Current* <sup>1</sup> | I <sub>FP</sub> | 150        | 150   | mA   |
| Operating Temperature              | Topr            | -40°C~85°C |       |      |
| Storage Temperature                | Tstg            | -40°C~85°C |       |      |

\*<sup>1</sup>Condition for I<sub>FP</sub> is pulse of 1/10 duty and 0.1msec width.

### ● Electrical and optical characteristics(Ta=25°C)

| Parameter                | Symbol          | Condition         | Color        | Min.       | Typ.       | Max.       | Unit |
|--------------------------|-----------------|-------------------|--------------|------------|------------|------------|------|
| Forward Voltage          | $V_F$           | $I_F=20\text{mA}$ | Red<br>Green | -          | 2.0<br>2.0 | 2.6<br>2.6 | V    |
| Luminous Intensity       | $I_v$           | $I_F=20\text{mA}$ | Red<br>Green | -          | 130<br>55  | -          | mcd  |
| Peak Wave Length         | $\lambda_p$     | $I_F=20\text{mA}$ | Red<br>Green | -          | 645<br>570 | -          | nm   |
| Dominant Wave Length     | $\lambda_d$     | $I_F=20\text{mA}$ | Red<br>Green | 624<br>564 | -<br>-     | 634<br>576 | nm   |
| Spectral Line Half-width | $\Delta\lambda$ | $I_F=20\text{mA}$ | Red<br>Green | -          | 20<br>30   | -          | nm   |
| Viewing Angle            | $2\theta_{1/2}$ | $I_F=20\text{mA}$ | Red<br>Green | -          | 55         | -          | deg  |

### ● Typical Electro-Optical Characteristics Curves

Fig.1 Relative intensity vs. Wavelength

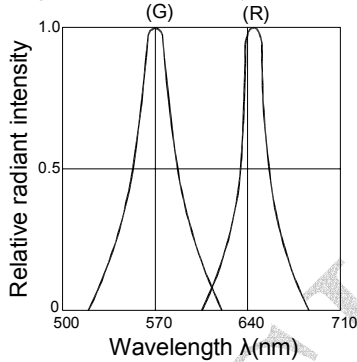

Fig.2 Forward current derating curve vs. Ambient temperature

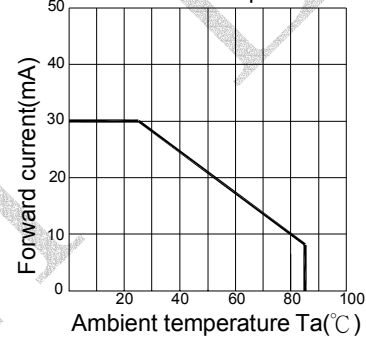

Fig.3 Forward current vs. Forward voltage

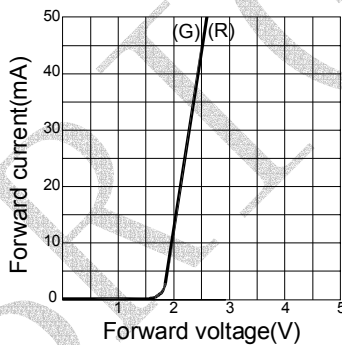

Fig.4 Relative luminous intensity vs. Ambient temperature

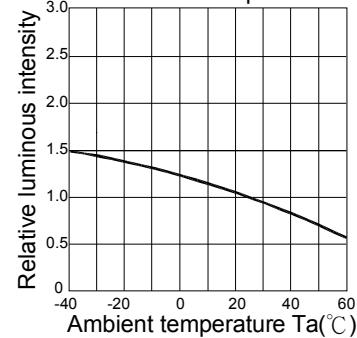

Fig.5 Relative luminous intensity vs. Forward current

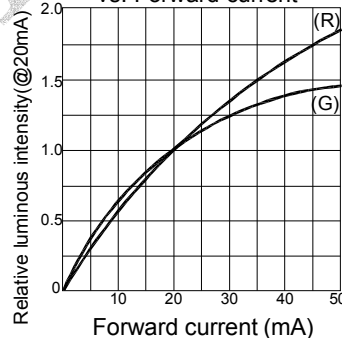
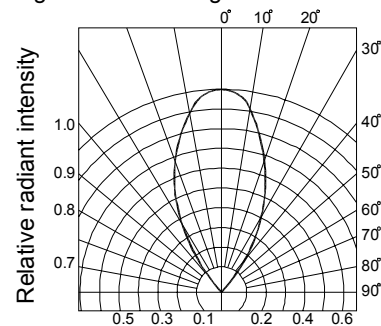

Fig.6 Radiation diagram



## ● Reliability Test

| Classification     | Test Item                              | Reference Standard  | Test Conditions  | Result |
|--------------------|--|---|--|--------|
| Endurance Test     | Operation Life                         | MIL-STD-750:1026<br>MIL-STD-883:1005<br>JIS-C-7021 :B-1                       | I <sub>F</sub> =20mA<br>Ta=+25°C±5°C<br>Test time=1,000hrs   | 0/32   |
|                    | High Temperature High Humidity Storage | MIL-STD-202:103B<br>JIS-C-7021 :B-11  | Ta=+85°C±5°C<br>RH=90%-95%<br>Test time=240hrs   | 0/32   |
|                    | High Temperature Storage               | MIL-STD-883:1008<br>JIS-C-7021 :B-10  | High Ta=+85°C±5°C<br>Test time=1,000hrs  | 0/32   |
|                    | Low Temperature Storage                | JIS-C-7021 :B-12  | Low Ta=-45°C±5°C<br>Test time=1,000hrs   | 0/32   |
| Environmental Test | Temperature Cycling                    | MIL-STD-202:107D<br>MIL-STD-750:1051<br>MIL-STD-883:1010<br>JIS-C-7021 :A-4   | Ta: +85°C (30min) ~ +25°C (5min) ~<br>-45°C (30min) ~ +25°C (5min)<br>Test Time : 70min/cycle 10cycle    | 0/32   |
|                    | Thermal Shock                          | MIL-STD-202:107D<br>MIL-STD-750:1051<br>MIL-STD-883:1011                      | -45°C±5°C ~+85°C±5°C<br>20min 20min<br>Test Time=10cycle   | 0/32   |
|                    | Solder Resistance                      | MIL-STD-202:201A<br>MIL-STD-750:2031<br>JIS-C-7021 :A-1                       | Preheating :<br>120°C, within 120-180 sec.<br>Operation heating :<br>255°C±5°C within 5 sec. 260°C (Max) | 0/32   |
|                    | Solderability                          | MIL-STD-202F:208D<br>MIL-STD-750D:2026<br>MIL-STD-883D:2003<br>JIS C 7021:A-2 | T.sol=230±5°C<br>Dwell Time=5±1secs  | 0/32   |

## ● Judgment criteria of failure for the reliability

| Measuring items    | Symbol                | Measuring conditions | Judgment criteria for failure |
|--------------------|-----------------------|----------------------|-------------------------------|
| Forward voltage    | V <sub>F</sub> (V)    | I <sub>F</sub> =20mA | Over U <sup>1</sup> x1.2      |
| Reverse current    | I <sub>R</sub> (uA)   | V <sub>R</sub> =5V   | Over U <sup>1</sup> x2        |
| Luminous intensity | I <sub>v</sub> ( mcd) | I <sub>F</sub> =20mA | Below S <sup>1</sup> X0.5     |

Note: 1. U means the upper limit of specified characteristics. S means initial value.

2. Measurement shall be taken between 2 hours and after the test pieces have been returned to normal ambient conditions after completion of each test.

### ● Dip Soldering

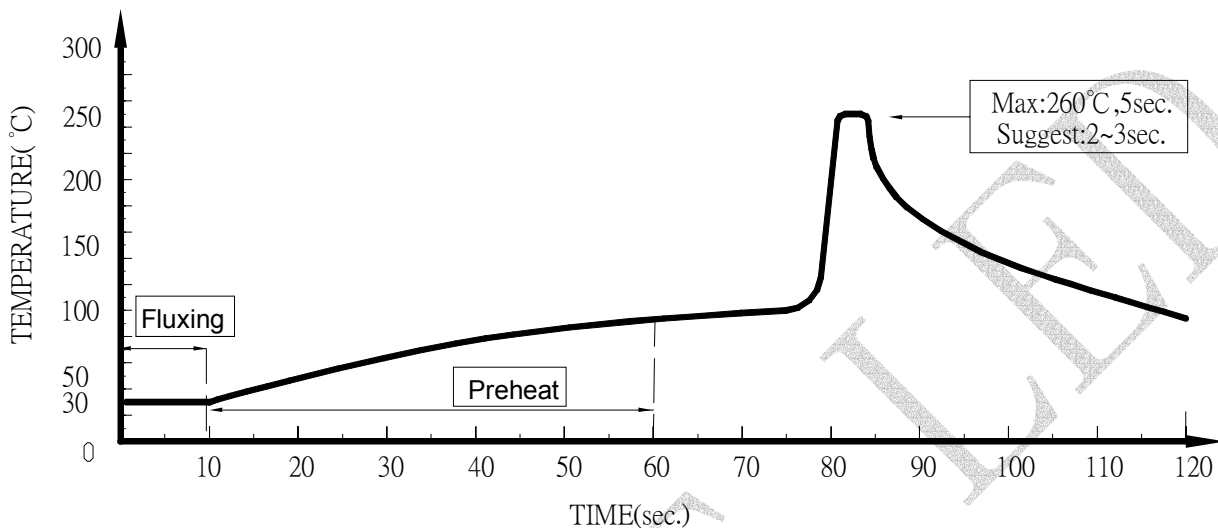

1. Please avoid any external stress applied to the lead-frames and epoxy while the LEDs are at high temperature, especially during soldering
2. DIP soldering and hand soldering should not be done more than one time.
3. After soldering, avoid the epoxy lens from mechanical shock or vibration until the LEDs are back to room temperature.
4. Avoid rapid cooling during temperature ramp-down process
5. Although the soldering condition is recommended above, soldering at the lowest possible temperature is feasible for the LEDs

### ● IRON Soldering

A : Max : 350°C Within 3 sec. One time only.

B : For 3mm LED without flange, if the LED epoxy lays flat on the PCB, the welding condition is 350°C within 2 seconds, one time only.

