

T4016

Heavy-Duty Metal-Body Safety Interlock Switch

- Rugged enclosure—the all metal housing and stainless steel actuator of the T4016 makes it suitable for harsh environments
- NEMA 6/IP67 enclosure enables these switches to withstand water washdown cleaning.
- Rotatable head gives eight possible actuator entry points for versatile installation. A blanking plug is supplied for the unused entry.
- Long life—these switches, with their stainless steel actuators, are designed for a minimum of two million actuations
- A variety of 4 contact pole versions provides 2 poles for dual channel safety monitoring and 2 additional poles for status monitoring
- A Rapid Delivery Product: Select models are available for shipment today or within 3 to 5 days



Conforms to EN60947-5-1, EN1088, EN ISO 13849-1
UL and C-UL listed
DGV approved

G

Specifications

Electrical	All Models
Contact Configurations:	2 N/C + 2 N/O, 3 N/C + 1 N/O, 4 N/C
Safety Contacts:	2 N/C, 3 N/C or 4 N/C positive break
Switching Ability	AC: 230 V, 4 A DC: 24 V, 4 A
Contact Material:	Silver alloy, gold flashed
Auxiliary Contacts:	1 N/O, 2 N/O
Minimum Switching Voltage:	12 V at 10 mA
Minimum Switching Current:	1 mA at 24 V
Mechanical	
Mounting:	Any position
Mounting Hardware:	2 x M5 screws (not supplied)
Min Operating Radius:	Approximately 300 mm (12 in.) with 90-degree actuator
Break Contact Min Force:	50 N (11.2 lb.)
Max Actuation Speed:	20 m/min.
Max Actuation Frequency:	112 cycles/min.
Case Material:	Die-cast alloy, cathodically dipped
Actuator Material:	Stainless steel
Wiring Entry:	3 x 0.5 in. NPT
Weight:	400 g (14 oz.)
Color:	Black with red lid
Mechanical Life:	2 x 10 ⁶ operations
Environmental	
Protection:	IP67 (NEMA 6)
Operating Temperature:	-20 to 80°C (-4 to 176°F)
Cleaning:	Water washdown
Compliance	
Standards:	EN60947-5-1, EN1088, EN ISO 13849-1
Approvals/Listings:	CE marked for all applicable directives, UL and C-UL, DGV
Reliability Data	
per EN ISO 13849-1:	B10d: 4.50E+06

Specifications are subject to change without notice.

Note: The safety contacts of the STI switches are described as normally closed (N/C)—i.e., with the guard closed, actuator in place, and the machine able to be started.

Select models are available for Rapid Delivery.

Visit this product on www.sti.com for details.

Operation

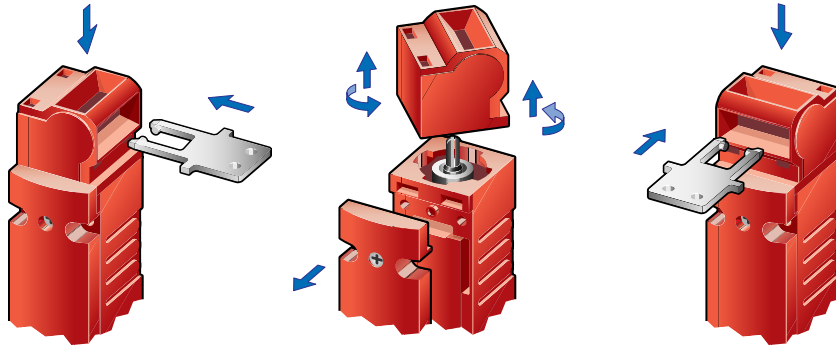

Contact Arrangements

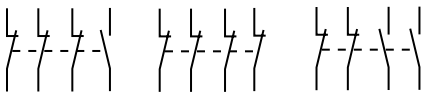

Flat Actuator

Flexible rubber mounting bushings allow for some actuator flexibility.



90-Degree Actuator

Flexible rubber mounting bushings allow for some actuator flexibility.



Flexible 1 Actuator

15 degree flexibility may be adjusted with the set screw.



Flexible 2 Actuator

15 degree flexibility may be adjusted with the set screw.



Optional Slide Bolt

- Allows easy installation of switch on machine guards
- Actuator included (order switch separately)
- Integral handle included
- Robust for use with heavy doors
- Slotted hole in bolt permits attaching multiple padlocks
- Yellow color for easy recognition

Optional SLD Series

Optional switch locking devices are available. See accessories section for details.



 Select models are available for Rapid Delivery.

Visit this product on www.sti.com for details.

Applications

Typical applications are on sliding guard doors or swinging guard doors.

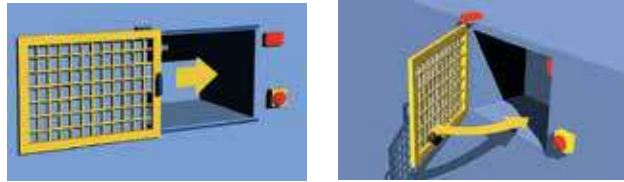

24VAC/DC, 110VAC, 230VAC

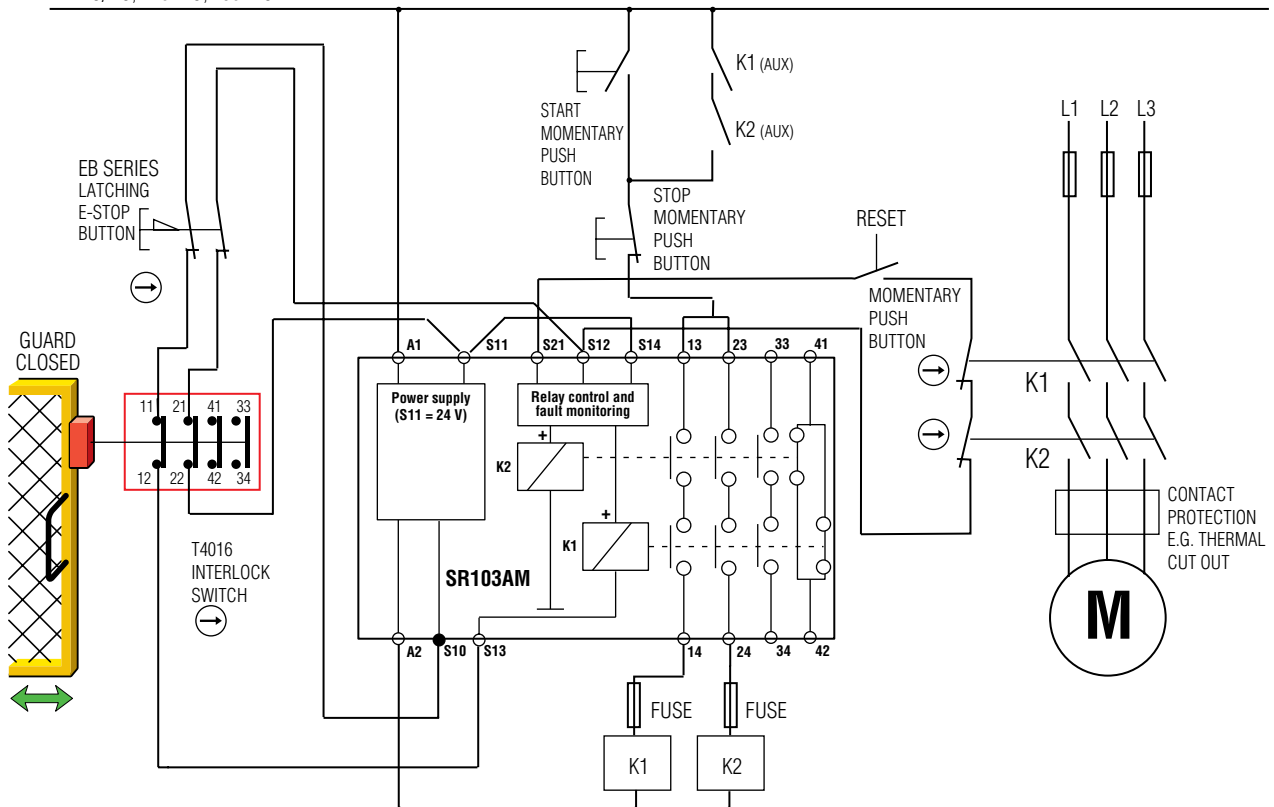

 For a full explanation of the circuit operating principle and fault detection, see “Common Circuit Examples” in the Expert Area Section of this catalog on page G-103

 Select models are available for Rapid Delivery.

Visit this product on www.sti.com for details.

Dimensions

(mm/in.)

T4016

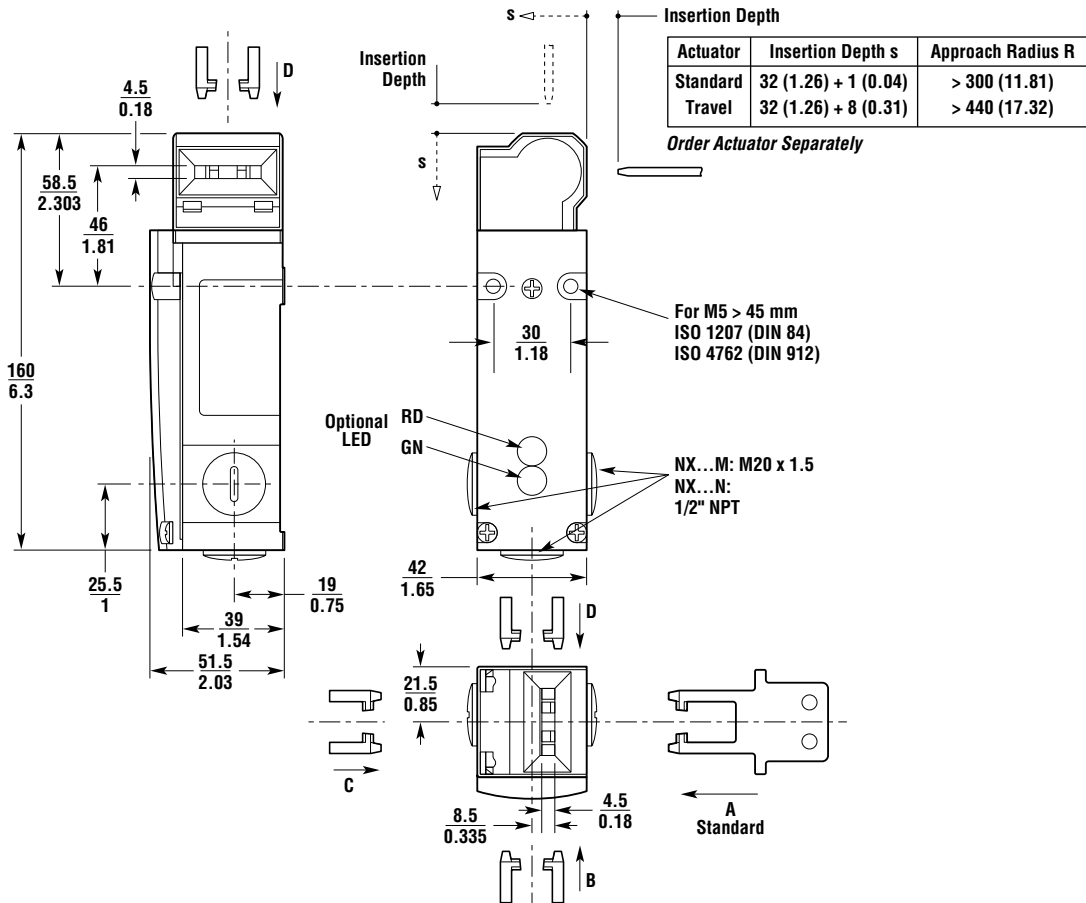

Flat Actuator

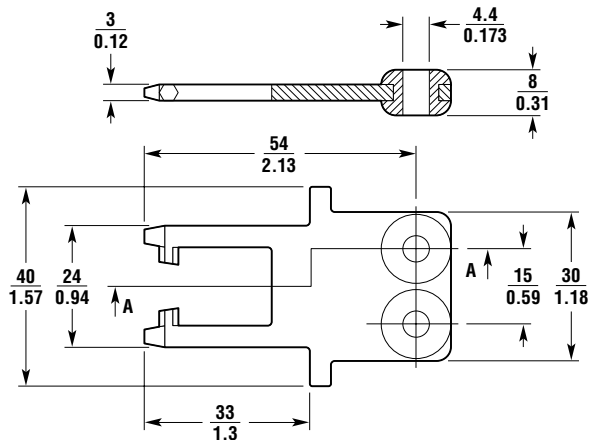

90-degree Actuator

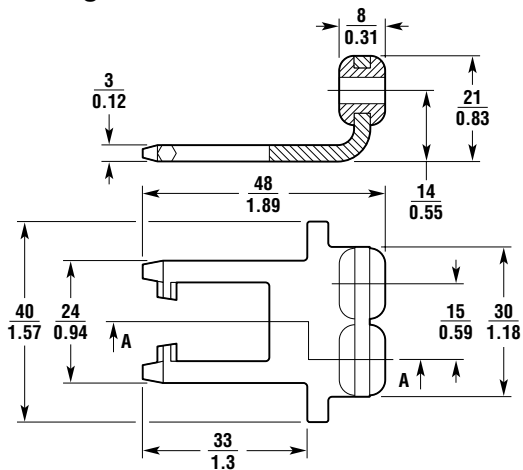

Select models are available for Rapid Delivery.

Visit this product on www.sti.com for details.



www.sti.com/info



Ordering

Model	Contacts	Wiring Entry	Part No.
T4019 90-Degree Actuator			
T4016-031SM	3 N/C + 1 N/O	3 X 0.5 in. NPT conduit	44539-0010
T4016-022SM	2 N/C + 2 N/O	3 X 0.5 in. NPT conduit	44539-0020
T4016-040SM	4 N/C	3 X 0.5 in. NPT conduit	44539-0030
T4016 Flat Actuator			
T4016-031TM	3 N/C + 1 N/O	3 X 0.5 in. NPT conduit	44539-0110
T4016-022TM	2 N/C + 2 N/O	3 X 0.5 in. NPT conduit	44539-0120
T4016-040TM	4 N/C	3 X 0.5 in. NPT conduit	44539-0130
T4016 Flex 1 Actuator			
T4016-031F1M	3 N/C + 1 N/O	3 X 0.5 in. NPT conduit	44539-0210
T4016-022F1M	2 N/C + 2 N/O	3 X 0.5 in. NPT conduit	44539-0220
T4016-040F1M	4 N/C	3 X 0.5 in. NPT conduit	44539-0230
T4016 Flex 2 Actuator			
T4016-031F2M	3 N/C + 1 N/O	3 X 0.5 in. NPT conduit	44539-0310
T4016-022F2M	2 N/C + 2 N/O	3 X 0.5 in. NPT conduit	44539-0320
T4016-040F2M	4 N/C	3 X 0.5 in. NPT conduit	44539-0330
Switch Only Models (no actuator and no adapter included)			
T4016-031	3 N/C + 1 N/O	3 X 0.5 in. NPT conduit	44539-2010
T4016-022	2 N/C + 2 N/O	3 X 0.5 in. NPT conduit	44539-2020
T4016-040	4 N/C	3 X 0.5 in. NPT conduit	44539-2030
Accessories			
Standard Actuators with Rubber Bushing			
Replacement flat actuator RB for T4016			44535-0700
Replacement 90-degree actuator RB for T4016			44535-0710
Overtravel Actuators with Rubber Bushing			
Replacement flat actuator OTRB for T4016			44535-0720
Replacement 90-degree actuator OTRB for T4016			44535-0730
Flexible Actuators			
Replacement flex 1 actuator for T4016			44535-0750
Replacement flex 2 actuator for T4016			44535-0760
Slide Bolts			
Bracket with handle for right-hung door for T4016 (yellow)			44535-8000
Bracket with handle for left-hung door for T4016 (yellow)			44535-8010
Miscellaneous			
LED lid kit for T4016			44539-0790

G

 Select models are available for Rapid Delivery.

Visit this product on www.sti.com for details.

Terms and Conditions of Sale

1. **Offer; Acceptance.** These terms and conditions (these "Terms") are deemed part of all quotes, agreements, purchase orders, acknowledgments, price lists, catalogs, manuals, brochures and other documents, whether electronic or in writing, relating to the sale of products or services (collectively, the "Products") by Omron Electronics LLC and its subsidiary companies ("Omron"). Omron objects to any terms or conditions proposed in Buyer's purchase order or other documents which are inconsistent with, or in addition to, these Terms.
2. **Prices; Payment Terms.** All prices stated are current, subject to change without notice by Omron. Omron reserves the right to increase or decrease prices on any unshipped portions of outstanding orders. Payments for Products are due net 30 days unless otherwise stated in the invoice.
3. **Discounts.** Cash discounts, if any, will apply only on the net amount of invoices sent to Buyer after deducting transportation charges, taxes and duties, and will be allowed only if (i) the invoice is paid according to Omron's payment terms and (ii) Buyer has no past due amounts.
4. **Interest.** Omron, at its option, may charge Buyer 1-1/2% interest per month or the maximum legal rate, whichever is less, on any balance not paid within the stated terms.
5. **Orders.** Omron will accept no order less than \$200 net billing.
6. **Governmental Approvals.** Buyer shall be responsible for, and shall bear all costs involved in, obtaining any government approvals required for the importation or sale of the Products.
7. **Taxes.** All taxes, duties and other governmental charges (other than general real property and income taxes), including any interest or penalties thereon, imposed directly or indirectly on Omron or required to be collected directly or indirectly by Omron for the manufacture, production, sale, delivery, importation, consumption or use of the Products sold hereunder (including customs duties and sales, excise, use, turnover and license taxes) shall be charged to and remitted by Buyer to Omron.
8. **Financial.** If the financial position of Buyer at any time becomes unsatisfactory to Omron, Omron reserves the right to stop shipments or require satisfactory security or payment in advance. If Buyer fails to make payment or otherwise comply with these Terms or any related agreement, Omron may (without liability and in addition to other remedies) cancel any unshipped portion of Products sold hereunder and stop any Products in transit until Buyer pays all amounts, including amounts payable hereunder, whether or not then due, which are owing to it by Buyer. Buyer shall in any event remain liable for all unpaid accounts.
9. **Cancellation; Etc.** Orders are not subject to rescheduling or cancellation unless Buyer indemnifies Omron against all related costs or expenses.
10. **Force Majeure.** Omron shall not be liable for any delay or failure in delivery resulting from causes beyond its control, including earthquakes, fires, floods, strikes or other labor disputes, shortage of labor or materials, accidents to machinery, acts of sabotage, riots, delay in or lack of transportation or the requirements of any government authority.
11. **Shipping; Delivery.** Unless otherwise expressly agreed in writing by Omron:
 - a. Shipments shall be by a carrier selected by Omron; Omron will not drop ship except in "break down" situations.
 - b. Such carrier shall act as the agent of Buyer and delivery to such carrier shall constitute delivery to Buyer;
 - c. All sales and shipments of Products shall be FOB shipping point (unless otherwise stated in writing by Omron), at which point title and risk of loss shall pass from Omron to Buyer; provided that Omron shall retain a security interest in the Products until the full purchase price is paid;
 - d. Delivery and shipping dates are estimates only; and
 - e. Omron will package Products as it deems proper for protection against normal handling and extra charges apply to special conditions.
12. **Claims.** Any claim by Buyer against Omron for shortage or damage to the Products occurring before delivery to the carrier must be presented in writing to Omron within 30 days of receipt of shipment and include the original transportation bill signed by the carrier noting that the carrier received the Products from Omron in the condition claimed.
13. **Warranties.** (a) **Exclusive Warranty.** Omron's exclusive warranty is that the Products will be free from defects in materials and workmanship for a period of twelve months from the date of sale by Omron (or such other period expressed in writing by Omron). Omron disclaims all other warranties, express or implied. (b) **Limitations.** OMRON MAKES NO WARRANTY OR REPRESENTATION, EXPRESS OR IMPLIED, ABOUT NON-INFRINGEMENT, MERCHANTABILITY OR FITNESS FOR A PARTICULAR PURPOSE OF THE PRODUCTS. BUYER ACKNOWLEDGES THAT IT ALONE HAS DETERMINED THAT THE PRODUCTS WILL SUITABLY MEET THE REQUIREMENTS OF THEIR INTENDED USE. Omron further disclaims all warranties and responsibility of any type for claims or expenses based on infringement by the Products or otherwise of any intellectual property right. (c) **Buyer Remedy.** Omron's sole obligation hereunder shall be, at Omron's election, to (i) replace (in the form originally shipped with Buyer responsible for labor charges for removal or replacement thereof) the non-complying Product, (ii) repair the non-complying Product, or (iii) repay or credit Buyer an amount equal to the purchase price of the non-complying Product; provided that in no event shall Omron be responsible for warranty, repair, indemnity or any other claims or expenses regarding the Products unless Omron's analysis confirms that the Products were properly handled, stored, installed and maintained and not subject to contamination, abuse, misuse or inappropriate modification. Return of any Products by Buyer must be approved in writing by Omron before shipment. Omron Companies shall not be liable for the suitability or unsuitability or the results from the use of Products in combination with any electrical or electronic components, circuits, system assemblies or any other materials or substances or environments. Any advice, recommendations or information given orally or in writing, are not to be construed as an amendment or addition to the above warranty. See <http://www.omron247.com> or contact your Omron representative for published information.
14. **Limitation on Liability; Etc.** OMRON COMPANIES SHALL NOT BE LIABLE FOR SPECIAL, INDIRECT, INCIDENTAL, OR CONSEQUENTIAL DAMAGES, LOSS OF PROFITS OR PRODUCTION OR COMMERCIAL LOSS IN ANY WAY CONNECTED WITH THE PRODUCTS, WHETHER SUCH CLAIM IS BASED IN CONTRACT, WARRANTY, NEGLIGENCE OR STRICT LIABILITY. Further, in no event shall liability of Omron Companies exceed the individual price of the Product on which liability is asserted.
15. **Indemnities.** Buyer shall indemnify and hold harmless Omron Companies and their employees from and against all liabilities, losses, claims, costs and expenses (including attorney's fees and expenses) related to any claim, investigation, litigation or proceeding (whether or not Omron is a party) which arises or is alleged to arise from Buyer's acts or omissions under these Terms or in any way with respect to the Products. Without limiting the foregoing, Buyer (at its own expense) shall indemnify and hold harmless Omron and defend or settle any action brought against such Companies to the extent based on a claim that any Product made to Buyer specifications infringed intellectual property rights of another party.
16. **Property; Confidentiality.** Any intellectual property in the Products is the exclusive property of Omron Companies and Buyer shall not attempt to duplicate it in any way without the written permission of Omron. Notwithstanding any charges to Buyer for engineering or tooling, all engineering and tooling shall remain the exclusive property of Omron. All information and materials supplied by Omron to Buyer relating to the Products are confidential and proprietary, and Buyer shall limit distribution thereof to its trusted employees and strictly prevent disclosure to any third party.
17. **Export Controls.** Buyer shall comply with all applicable laws, regulations and licenses regarding (i) export of products or information; (iii) sale of products to "forbidden" or other proscribed persons; and (ii) disclosure to non-citizens of regulated technology or information.
18. **Miscellaneous.** (a) **Waiver.** No failure or delay by Omron in exercising any right and no course of dealing between Buyer and Omron shall operate as a waiver of rights by Omron. (b) **Assignment.** Buyer may not assign its rights hereunder without Omron's written consent. (c) **Law.** These Terms are governed by the law of the jurisdiction of the home office of the Omron company from which Buyer is purchasing the Products (without regard to conflict of law principles). (d) **Amendment.** These Terms constitute the entire agreement between Buyer and Omron relating to the Products, and no provision may be changed or waived unless in writing signed by the parties. (e) **Severability.** If any provision hereof is rendered ineffective or invalid, such provision shall not invalidate any other provision. (f) **Setoff.** Buyer shall have no right to set off any amounts against the amount owing in respect of this invoice. (g) **Definitions.** As used herein, "including" means "including without limitation"; and "Omron Companies" (or similar words) mean Omron Corporation and any direct or indirect subsidiary or affiliate thereof.

Certain Precautions on Specifications and Use

1. **Suitability of Use.** Omron Companies shall not be responsible for conformity with any standards, codes or regulations which apply to the combination of the Product in the Buyer's application or use of the Product. At Buyer's request, Omron will provide applicable third party certification documents identifying ratings and limitations of use which apply to the Product. This information by itself is not sufficient for a complete determination of the suitability of the Product in combination with the end product, machine, system, or other application or use. Buyer shall be solely responsible for determining appropriateness of the particular Product with respect to Buyer's application, product or system. Buyer shall take application responsibility in all cases but the following is a non-exhaustive list of applications for which particular attention must be given:
 - (i) Outdoor use, uses involving potential chemical contamination or electrical interference, or conditions or uses not described in this document.
 - (ii) Use in consumer products or any use in significant quantities.
 - (iii) Energy control systems, combustion systems, railroad systems, aviation systems, medical equipment, amusement machines, vehicles, safety equipment, and installations subject to separate industry or government regulations.
 - (iv) Systems, machines and equipment that could present a risk to life or property. Please know and observe all prohibitions of use applicable to this Product.

NEVER USE THE PRODUCT FOR AN APPLICATION INVOLVING SERIOUS RISK TO LIFE OR PROPERTY OR IN LARGE QUANTITIES WITHOUT ENSURING THAT THE SYSTEM AS A WHOLE HAS BEEN DESIGNED TO ADDRESS THE RISKS, AND THAT THE OMRON'S PRODUCT IS PROPERLY RATED AND INSTALLED FOR THE INTENDED USE WITHIN THE OVERALL EQUIPMENT OR SYSTEM.
2. **Programmable Products.** Omron Companies shall not be responsible for the user's programming of a programmable Product, or any consequence thereof.
3. **Performance Data.** Data presented in Omron Company websites, catalogs and other materials is provided as a guide for the user in determining suitability and does not constitute a warranty. It may represent the result of Omron's test conditions, and the user must correlate it to actual application requirements. Actual performance is subject to the Omron's Warranty and Limitations of Liability.
4. **Change in Specifications.** Product specifications and accessories may be changed at any time based on improvements and other reasons. It is our practice to change part numbers when published ratings or features are changed, or when significant construction changes are made. However, some specifications of the Product may be changed without any notice. When in doubt, special part numbers may be assigned to fix or establish key specifications for your application. Please consult with your Omron's representative at any time to confirm actual specifications of purchased Product.
5. **Errors and Omissions.** Information presented by Omron Companies has been checked and is believed to be accurate; however, no responsibility is assumed for clerical, typographical or proofreading errors or omissions.

OMRON AUTOMATION AND SAFETY • THE AMERICAS HEADQUARTERS • Chicago, IL USA • 847.843.7900 • 800.556.6766 • www.omron247.com

OMRON CANADA, INC. • HEAD OFFICE

Toronto, ON, Canada • 416.286.6465 • 866.986.6766 • www.omron247.com

OMRON ELECTRONICS DE MEXICO • HEAD OFFICE

México DF • 52.55.59.01.43.00 • 01-800-226-6766 • mela@omron.com

OMRON ELECTRONICS DE MEXICO • SALES OFFICE

Apodaca, N.L. • 52.81.11.56.99.20 • 01-800-226-6766 • mela@omron.com

OMRON ELETRÔNICA DO BRASIL LTDA • HEAD OFFICE

São Paulo, SP, Brasil • 55.11.2101.6300 • www.omron.com.br

OMRON ARGENTINA • SALES OFFICE

Cono Sur • 54.11.4783.5300

OMRON CHILE • SALES OFFICE

Santiago • 56.9.9917.3920

OTHER OMRON LATIN AMERICA SALES

54.11.4783.5300

OMRON EUROPE B.V. • Wegalaan 67-69, NL-2132 JD, Hoofddorp, The Netherlands. • +31 (0) 23 568 13 00 • www.industrial.omron.eu

Authorized Distributor:

Automation Control Systems

- Machine Automation Controllers (MAC) • Programmable Controllers (PLC)
- Operator interfaces (HMI) • Distributed I/O • Software

Drives & Motion Controls

- Servo & AC Drives • Motion Controllers & Encoders

Temperature & Process Controllers

- Single and Multi-loop Controllers

Sensors & Vision

- Proximity Sensors • Photoelectric Sensors • Fiber-Optic Sensors
- Amplified Photomicrosensors • Measurement Sensors
- Ultrasonic Sensors • Vision Sensors

Industrial Components

- RFID/Code Readers • Relays • Pushbuttons & Indicators
- Limit and Basic Switches • Timers • Counters • Metering Devices
- Power Supplies

Safety

- Laser Scanners • Safety Mats • Edges and Bumpers • Programmable Safety Controllers • Light Curtains • Safety Relays • Safety Interlock Switches