

P1: M-042

P2: M-048A

Customer No.: No.:1

P1

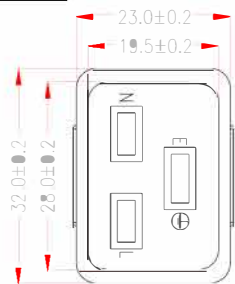

IEC 60320 C19(MSL-119)

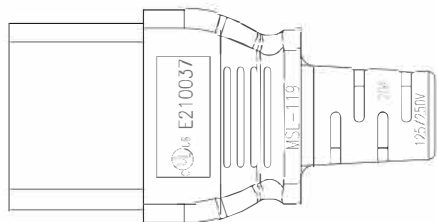

PACKING A: <1FT

PACKING B: <2FT

PACKING C: >2FT

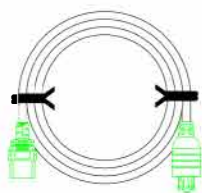
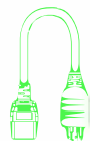
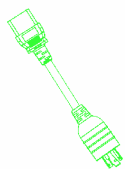

MARKING: (UL) SJT 3/C 12AWG(3.31MM²) VW-1 105°C 300V E204978

CSA SJT 3/C 3.31MM²(12AWG) FT2 105°C 300V 204790 MSL

P1 P2

BLACK L ————— T1
 WHITE N ————— T3
 GREEN E ————— T2

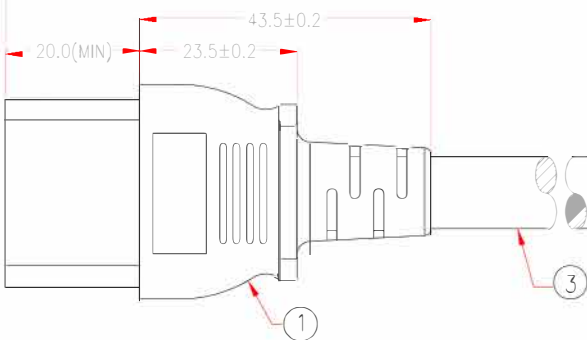

NEMA L5-20P(MSL-130)

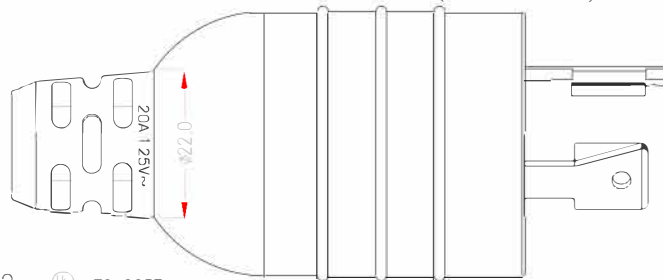

P1.P2: UL E210037

NOTE: All relevant materials are complied with RoHS directive .
THE CABLE MARKING IS CONCAVE LETTERING MOULD

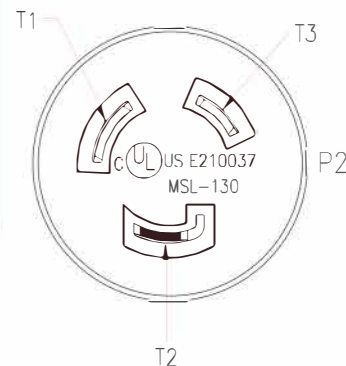

3	UL SJT 12AWG x 3C, OD 11.0mm, JACKET BLACK, DRAWING No. EPSJT011203C-158	H5TC41-0304K09	L-20mm	M304
2	MOLDED PVC 35P, COLOR BLACK	H1BC02-0304K09		M304
	BRACKET: L5-20 (94V-0) MSL-130	A1QC63-0767K09	1	M767
	TERMINAL: 97656BL-0 (T3)	A1QB39-0257	1	M257
	TERMINAL: 97655BL-0 (T2)	A1QB41-0257	1	M257
1	MOLDED PVC 35P, COLOR BLACK	H1BC02-0304K09		M304
	BRACKET: YST-037	A1QC36-0767K09	1	M767
	TERMINAL: 98739ABS-0	A1QB33-0257	3	M257

No.	DESCRIPTION	Q'TY	Supplier
-----	-------------	------	----------

APPROVED				Cable Length Unless Other Spec. Tolerances: 0 ~200mm ±10mm 201~1000mm ±20mm 1001 ~1500mm ±25mm 1501~2100mm ±30mm 2100mm↑ ±40mm	
CHECKED					HU
SETS DRAWING	XIAO	16/JAN/18	PRODUCT	NO. PWCD-L520PC19-20A-XXF-BLK	

REV.1 2018.01.16 MODIFY P2 PLUG TERMINAL SURFACE & SIZE

NOTE: Cable Length Unless Otherwise Spec. Tolerances: Under 6FT ±25mm; Another ±50mm

UNIT: mm