

CIRCUIT	PART NO.	DIM A	DIM B	COLOR
2	105411-1102	8.35	12.45	BLACK
4	105411-1104	12.05	16.15	
6	105411-1106	17.75	21.85	
8	105411-1108	23.45	27.55	
10	105411-1110	29.15	33.25	
12	105411-1112	34.85	38.95	

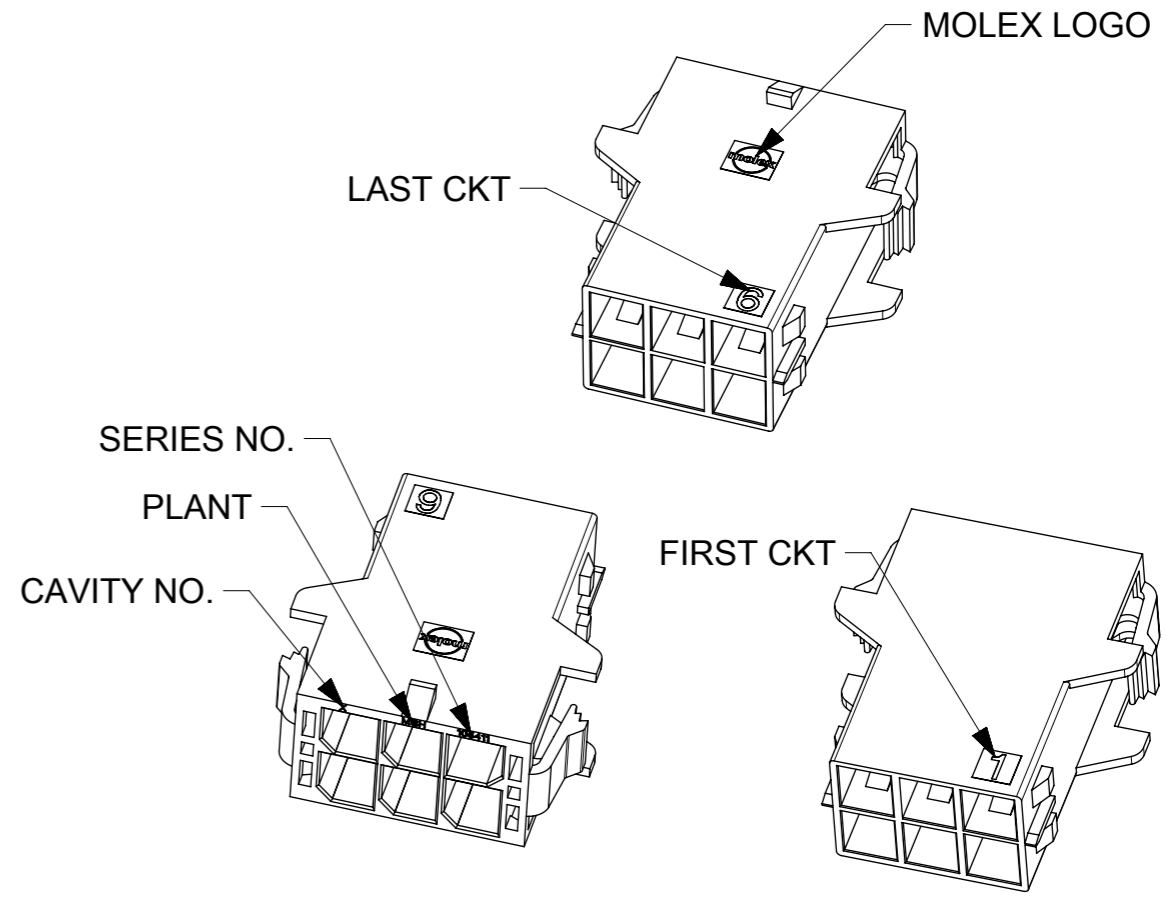

- NOTES:**
- MATERIAL: NYLON,UL 94V-0 AND GLOW WIRE CAPABLE PER IEC60335-1. COLOR BLACK.
  - PART USED WITH MOLEX SERIES.  
RECEPTACLE HOUSING: 171692  
TPA: 105415  
MALE TERMINAL: 105417/105418.
  - PRODUCT SPECIFICATION:1054171000-PS
  - PACKAGING SPECIFICATION: 1054110200
  - APPLICATION SPECIFICATION:768232000-AS

SYMBOLS	THIS DRAWING CONTAINS INFORMATION THAT IS PROPRIETARY TO MOLEX ELECTRONIC TECHNOLOGIES, LLC AND SHOULD NOT BE USED WITHOUT WRITTEN PERMISSION					
	DIMENSION UNITS	SCALE				
▽ = 0	mm		EC NO: 628261			MEGA-FIT PANEL MOUNT DR PLUG
▽ = 0	GENERAL TOLERANCES (UNLESS SPECIFIED)		DRWN: ALUO02 2019/11/28			
▽ = 0	ANGULAR TOL ± 0.5°		CHK'D: AYIN 2019/12/11			PRODUCT CUSTOMER DRAWING
▽ = 0	4 PLACES ±		APPR: AYIN 2019/12/11			
▽ = 0	3 PLACES ±		INITIAL REVISION:			DOCUMENT NUMBER
▽ = 0	2 PLACES ± 0.25		DRWN: YXZHENG 2016/12/15			
▽ = 0	1 PLACE ± 0.35		APPR: YXZHENG 2018/08/06			1054110200
▽ = 0	0 PLACES ±		THIRD ANGLE PROJECTION			
□ = 0	DRAFT WHERE APPLICABLE MUST REMAIN WITHIN DIMENSIONS		DRAWING	SERIES	MATERIAL NUMBER	DOC TYPE
▽ = 0			A3-SIZE	105411	SEE CHART	PSD
			CUSTOMER	SHEET NUMBER		DOC PART
			GENERAL MARKET	1 OF 2		REVISION
					D1	

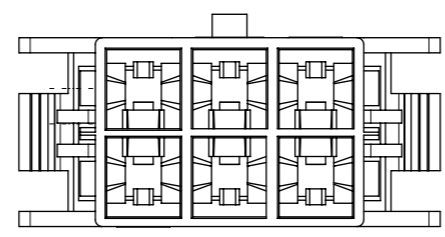
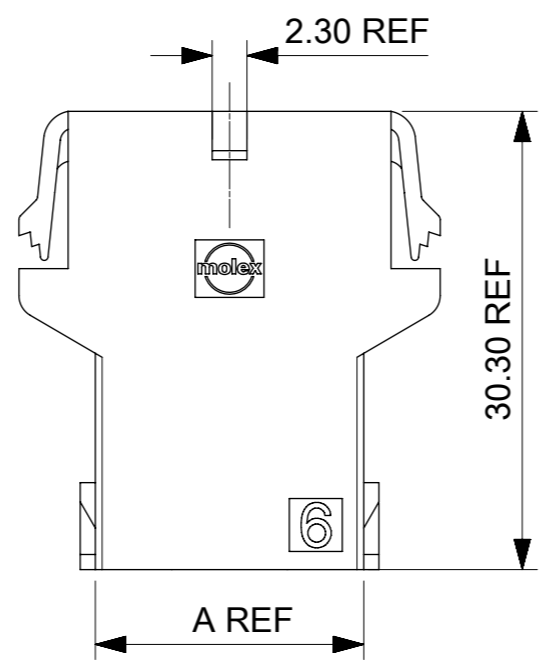
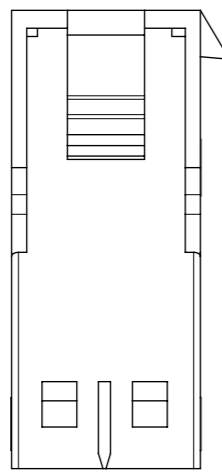
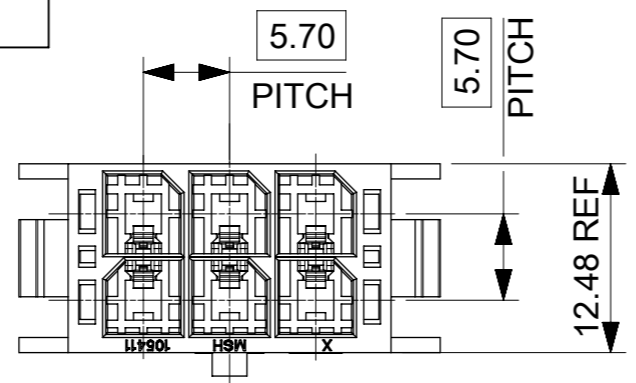
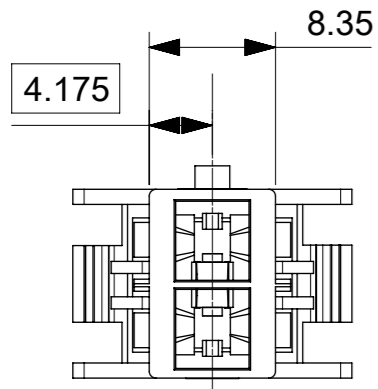

2 CIRCUITS

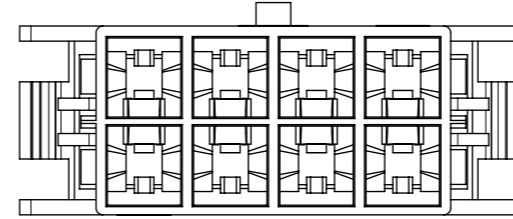
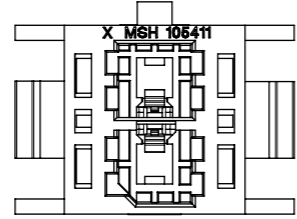

8 CIRCUITS

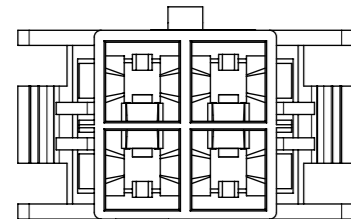
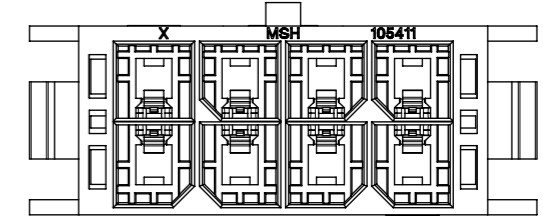

4 CIRCUITS

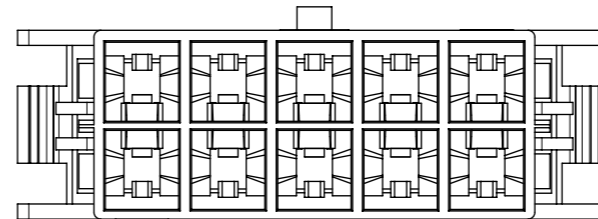
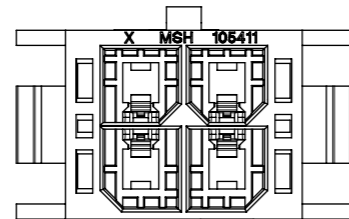

10 CIRCUITS

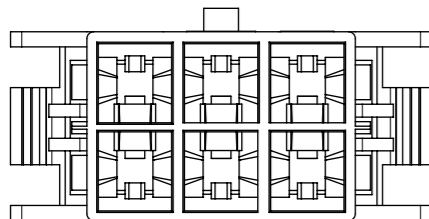
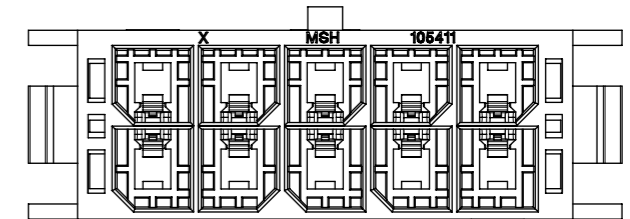

6 CIRCUITS

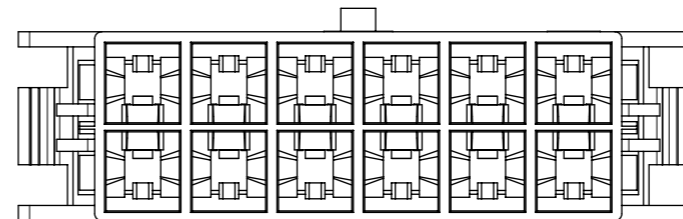
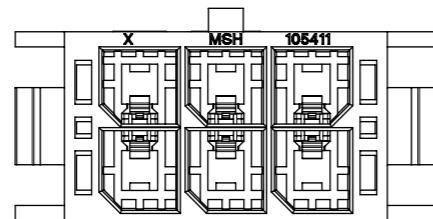

12 CIRCUITS

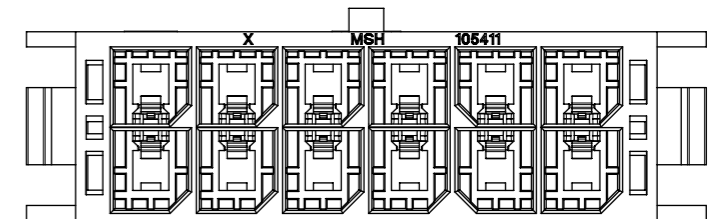

POLARIZATION LAYOUT

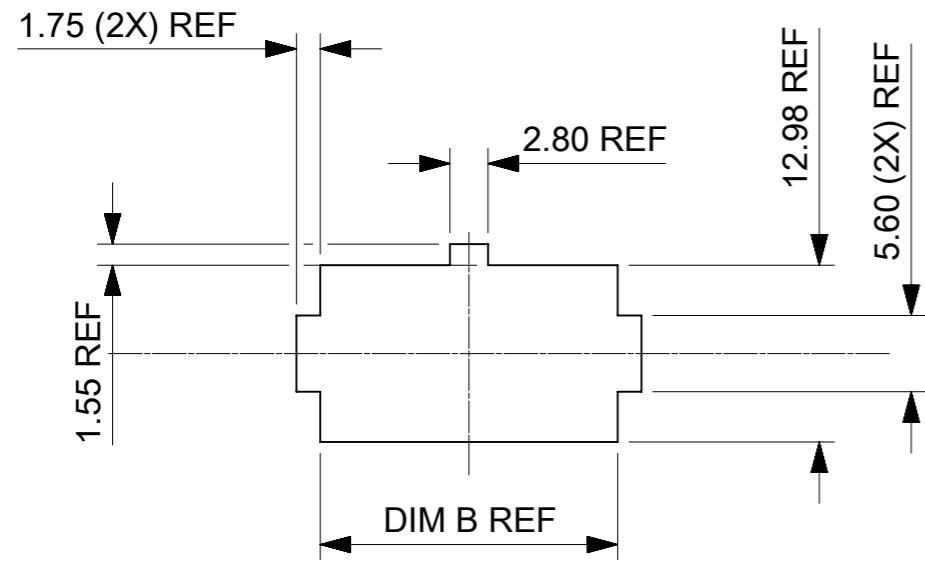

RECOMMEND PANEL APERTURE SIZE  
PANEL THICKNESS 1.2MM-2.0MM

SYMBOLS	THIS DRAWING CONTAINS INFORMATION THAT IS PROPRIETARY TO MOLEX ELECTRONIC TECHNOLOGIES, LLC AND SHOULD NOT BE USED WITHOUT WRITTEN PERMISSION		CURRENT REV DESC:		<b>molex</b>		
	DIMENSION UNITS	SCALE					
▽ = 0	mm		EC NO: 628261		DOCUMENT NUMBER		
▽ = 0	GENERAL TOLERANCES (UNLESS SPECIFIED)		DRWN: ALUO02		DOC TYPE		
▽ = 0	ANGULAR TOL ± 0.5°		2019/11/28		DOC PART		
▽ = 0	4 PLACES ±		CHK'D: AYIN		REVISION		
▽ = 0	3 PLACES ±		2019/12/11		1054110200		
▽ = 0	2 PLACES ± 0.25		APPR: AYIN		PSD		
▽ = 0	1 PLACE ± 0.35		INITIAL REVISION:		000		
▽ = 0	0 PLACES ±		DRWN: YXZHENG		D1		
▽ = 0	DRAFT WHERE APPLICABLE MUST REMAIN WITHIN DIMENSIONS		2016/12/15		2 OF 2		
▽ = 0	THIRD ANGLE PROJECTION		2018/08/06		SEE CHART		
▽ = 0	DRAWING		SERIES		GENERAL MARKET		
▽ = 0	A3-SIZE		105411		MATERIAL NUMBER		
▽ = 0					CUSTOMER		
▽ = 0					GENERAL MARKET		
▽ = 0					SHEET NUMBER		
▽ = 0					2 OF 2		