

DC - 700 MHz, 10 kOhm TRANSIMPEDANCE AMPLIFIER



Typical Applications

The HMC799LP3E is ideal for:

- Laser Sensor
- FDDI Receiver
- CATV FM Analog Receiver
- Wideband Gain Block
- Low Noise RF Applications

Features

- 10 kOhm Transimpedance
- Very Low Noise: 150nA Input RMS Noise over 700 MHz Bandwidth
- 700 MHz Analog Bandwidth
- Wide Dynamic Range: +65 dB
- Low Power: 70mA from Single +5V Supply
- 16 Lead 3x3 mm SMT Package: 9mm²

Functional Diagram

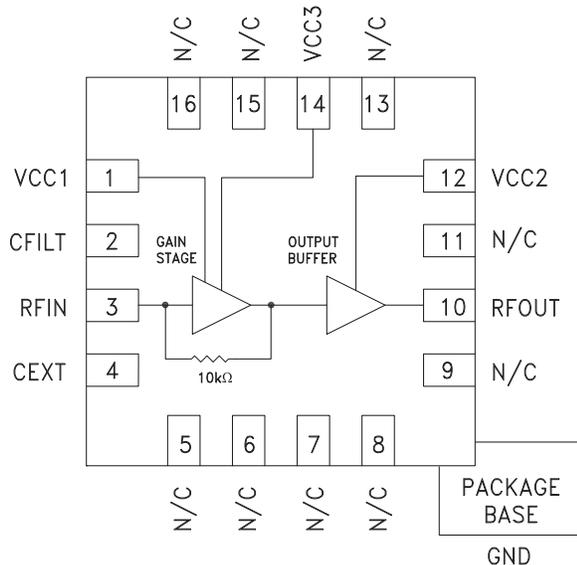

General Description

The HMC799LP3E is DC to 700 MHz Transimpedance amplifier designed for opto-electronic laser sensor applications, FDDI receivers and receiver systems employing optical to electrical conversion. This amplifier provides a single-ended output voltage that is proportional to an applied current at its input port. This current is typically provided by a photo-diode. Operating from a single +5V supply, HMC799LP3E features very low input referred noise, and very large electrical input dynamic range exceeding 65 dB. 10 kOhm or 80 dB-Ohms transimpedance gain provides very good sensitivity at higher data rates. The output of HMC799LP3E is internally matched to 50 ohms. External matching is not necessary. The HMC799LP3E exhibits excellent gain and output power stability over temperature, while requiring a minimal number of external bias components.

Electrical Specifications, $T_A = +25^\circ C$, $V_{cc1} = V_{cc2} = V_{cc3} = +5V$

Parameter	Conditions	Min.	Typ.	Max.	Units
DC Specifications					
Power Supply Voltage		4.5	5	5.5	V
Power Supply Current	$V_{cc} = 5V$	60	70	80	mA
Input Impedance	@ 350 MHz		175		Ohm
Input Bias Voltage			2.1		V
AC Specifications					
Transimpedance	@ 100 MHz, $R_L = 50 \text{ Ohm}$	7.5	10	12.5	k Ohms
Transimpedance 3-dB Bandwidth		600	700		MHz
Small Signal Gain	S21		42		dB
Input Referred Current Noise Density	$C_{pd}^{[1]} < 1\text{pF}$, @ 200 MHz		4.6		$\text{pA} / \sqrt{\text{Hz}}$
	$C_{pd}^{[1]} = 1\text{pF}$, @ 200 MHz		4.8		$\text{pA} / \sqrt{\text{Hz}}$
	$C_{pd}^{[1]} = 2\text{pF}$, @ 200 MHz		5.2		$\text{pA} / \sqrt{\text{Hz}}$
	$C_{pd}^{[1]} = 3\text{pF}$, @ 200 MHz		5.6		$\text{pA} / \sqrt{\text{Hz}}$

[1] Cpd is the total parasitic capacitance value arises from addition of input photo diode. This value includes photo diode parasitic capacitance, PCB trace capacitance and package parasitic capacitance.



DC - 700 MHz, 10 kOhm TRANSIMPEDANCE AMPLIFIER

Electrical Specifications (Conditions)

Parameter	Conditions	Min.	Typ.	Max.	Units
Input Referred RMS Current Noise	C _{pd} [1] <1pF, @ 700 MHz BW		149		nA RMS
	C _{pd} [1] = 1pF, @630 MHz BW		164		nA RMS
	C _{pd} [1] = 2pF, @ 560 MHz BW		174		nA RMS
	C _{pd} [1] = 3pF, @ 420 MHz BW		132		nA RMS
Saturated Output Swing	V _{in} = 50mV p-p		1		Vp-p
Output Power 1-dB Compression	OP1dB @ 200 MHz		4		dBm
Output Third Order Intercept Point	OIP3 @ 200 MHz		13		dBm
Input Overdrive Current			20		mA
Output Return Loss	@ 500 MHz	16	20		dB

Gain vs. Temperature

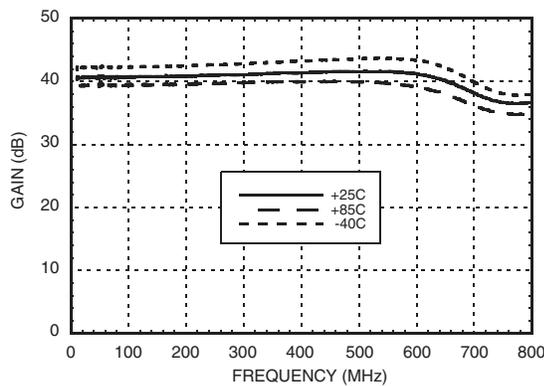

Output Return Loss vs. Temperature

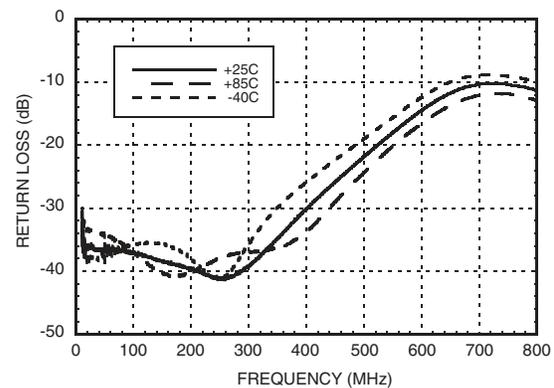

Input Referred Noise Density vs. C_{PD} [1]

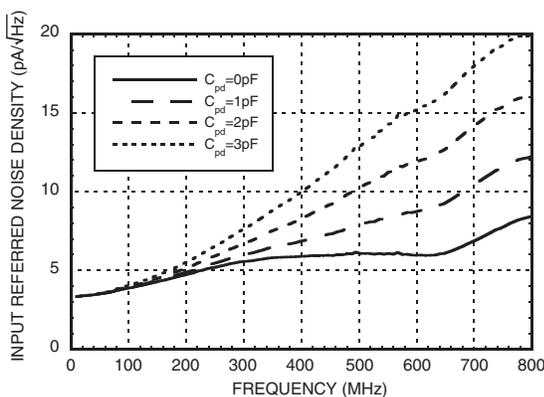

Input Referred Noise Density vs. Temperature [2]

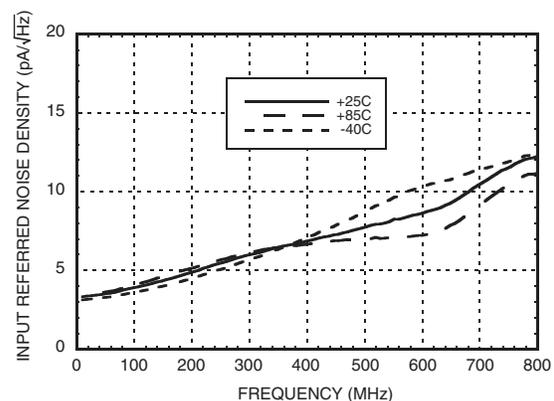

[1] C_{pd} is the total parasitic capacitance value resulting from the addition of the input photo diode. This value includes photo diode parasitic capacitance, PCB trace capacitance and package parasitic capacitance.

[2] C_{pd} = 1 pF



**DC - 700 MHz, 10 kOhm
TRANSIMPEDANCE AMPLIFIER**

Transimpedance vs. C_{PD} [1]

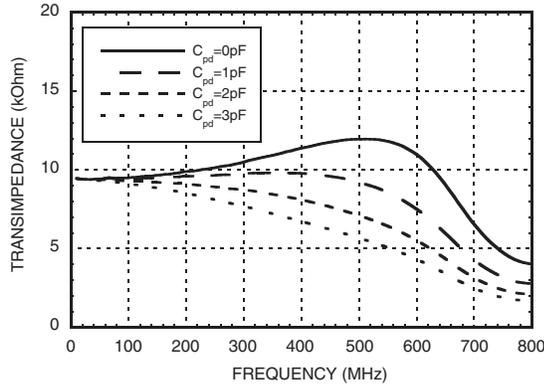

Transimpedance vs. Supply Voltage (V_{CC}) [2]

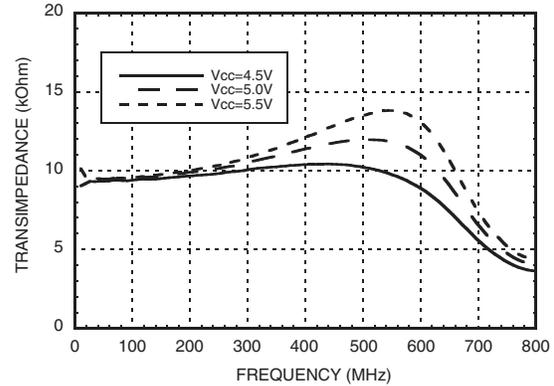

Transimpedance vs. Temperature [2]

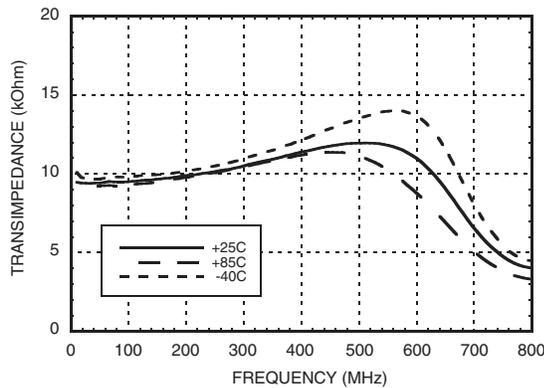

Output Power vs. Input Power @ 200 MHz [2]

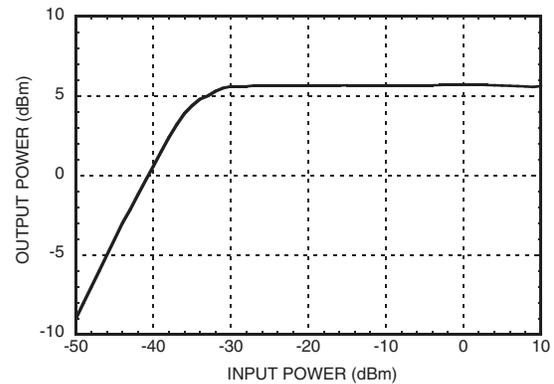

[1] C_{pd} is the total parasitic capacitance value resulting from the addition of the input photo diode. This value includes photo diode parasitic capacitance, PCB trace capacitance and package parasitic capacitance.

[2] $C_{pd} = 1\text{pF}$



**DC - 700 MHz, 10 kOhm
TRANSIMPEDANCE AMPLIFIER**

Output Signal [1]

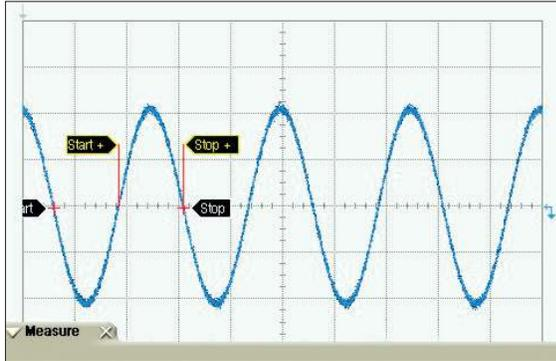

	Measurements					Units
	Current	Mean	std dev	Min.	Max	
V amptd	198.84	200.50	3.6253	184.99	212.70	mV
Frequency	200.8	199.9	0.631	198.0	202.1	MHz
Duty Cycle	50.9	49.7	0.62	47.6	51.6	%

[1] Input signal current 25 μ A-p, frequency 200 MHz

Output Signal [2]

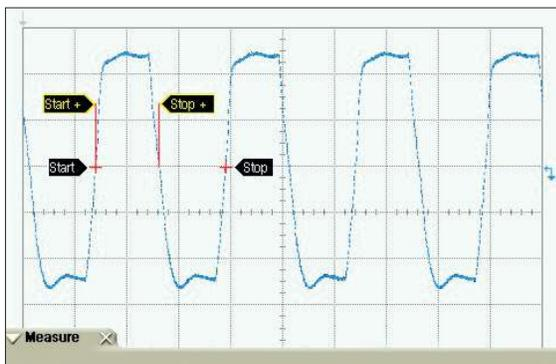

	Measurements					Units
	Current	Mean	std dev	Min.	Max	
V amptd	959.62	960.47	3.703	953.11	972.63	mV
Frequency	200.1	200.0	0.117	199.5	200.4	MHz
Duty Cycle	49.1	49	0.08	48.7	49.2	%

[2] Input signal current 20 mA-p, frequency 200 MHz



DC - 700 MHz, 10 kOhm TRANSIMPEDANCE AMPLIFIER

Absolute Maximum Ratings

Power Supply Voltage (Vcc1, Vcc2, Vcc3)	-1V to 8V
Input Current	30 mAp-p
Junction Temperature	125 °C
Continuous Pdiss (T=85 °C) (derate 31.82 mW/ °C Above +85 °C)	1.27W
Thermal Resistance (Junction to ground paddle)	31.43 °C/W
Storage Temperature	-65 to 125 °C
Operating Temperature	-40 to +85 °C
ESD Sensitivity (HBM)	Class 1C

Outline Drawing

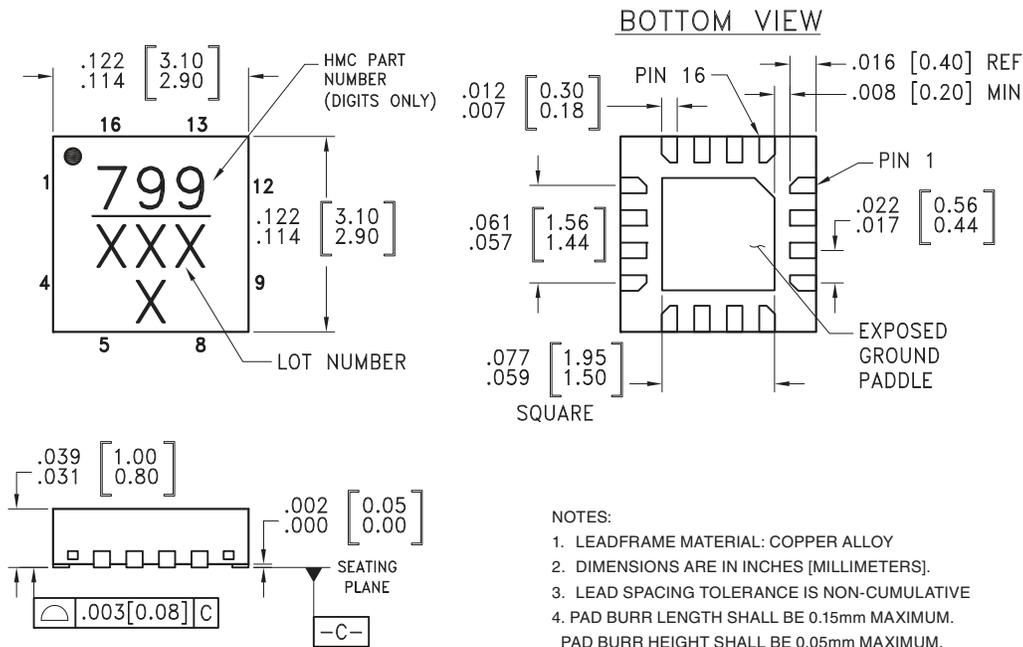

Package Information

Part Number	Package Body Material	Lead Finish	MSL Rating	Package Marking ^[1]
HMC799LP3E	RoHS-compliant Low Stress Injection Molded Plastic	100% matte Sn	MSL1 ^[2]	H799 XXXX

[1] 4-Digit lot number XXXX

[2] Max peak reflow temperature of 260 °C



DC - 700 MHz, 10 kOhm TRANSIMPEDANCE AMPLIFIER

Pin Descriptions

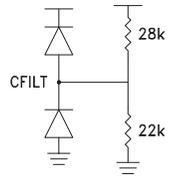
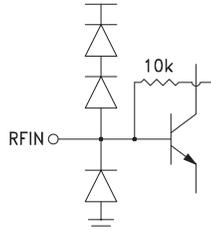
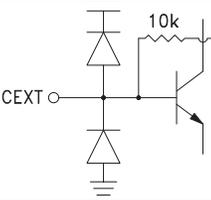
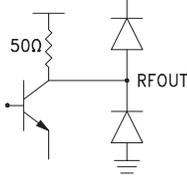
Pin Number	Function	Description	Interface Schematic
1, 12, 14	VCC1, VCC2, VCC3	Positive Supply	
2	CFILT	Overload current filter capacitance pin.	
3	RFIN	RF Input	
4	CEXT	Reference voltage filter capacitance pin.	
5 - 9, 11, 13, 15, 16	N/C	Not connected.	
10	RFOUT	RF Output	
Package Base	GND	Package base has exposed metal ground paddle which must be connected to ground.	

Information furnished by Analog Devices is believed to be accurate and reliable. However, no responsibility is assumed by Analog Devices for its use, nor for any infringements of patents or other rights of third parties that may result from its use. Specifications subject to change without notice. No license is granted by implication or otherwise under any patent or patent rights of Analog Devices. Trademarks and registered trademarks are the property of their respective owners.

For price, delivery, and to place orders: Analog Devices, Inc., One Technology Way, P.O. Box 9106, Norwood, MA 02062-9106 Phone: 781-329-4700 • Order online at www.analog.com Application Support: Phone: 1-800-ANALOG-D



**DC - 700 MHz, 10 kOhm
TRANSIMPEDANCE AMPLIFIER**

Application Circuit

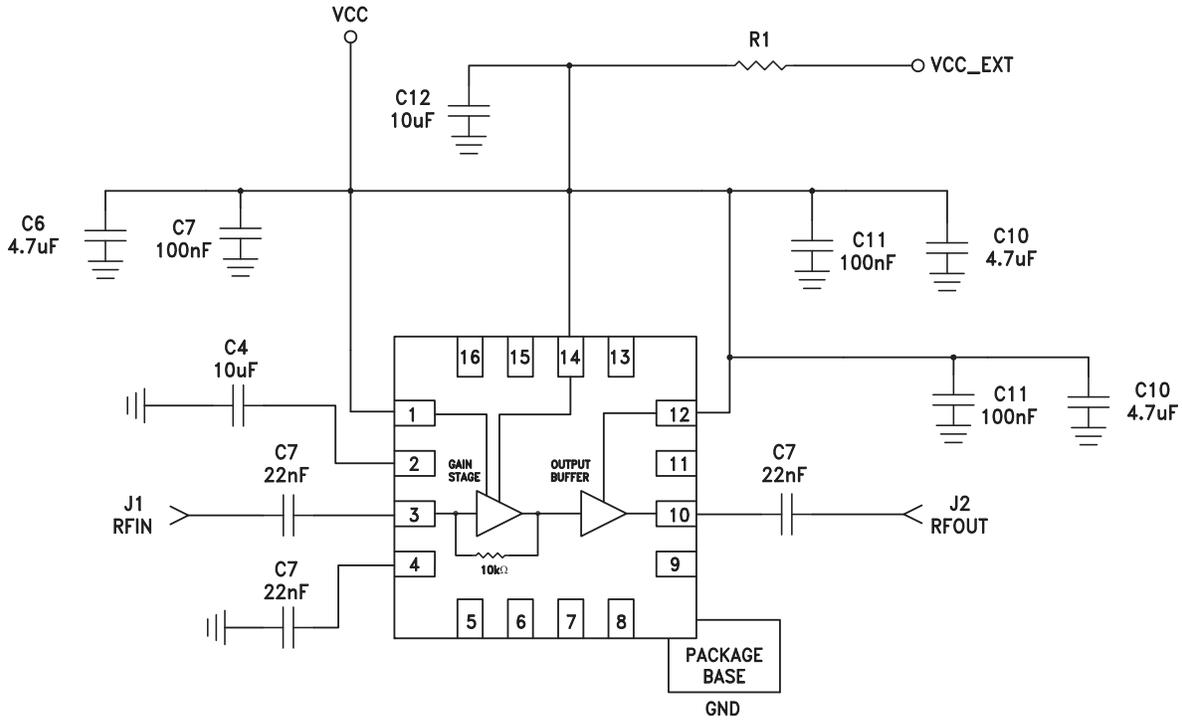

Note:
For power supply rejection ratio (PSRR) tests, install 0 Ohm for R1.



**DC - 700 MHz, 10 kOhm
TRANSIMPEDANCE AMPLIFIER**

Evaluation PCB

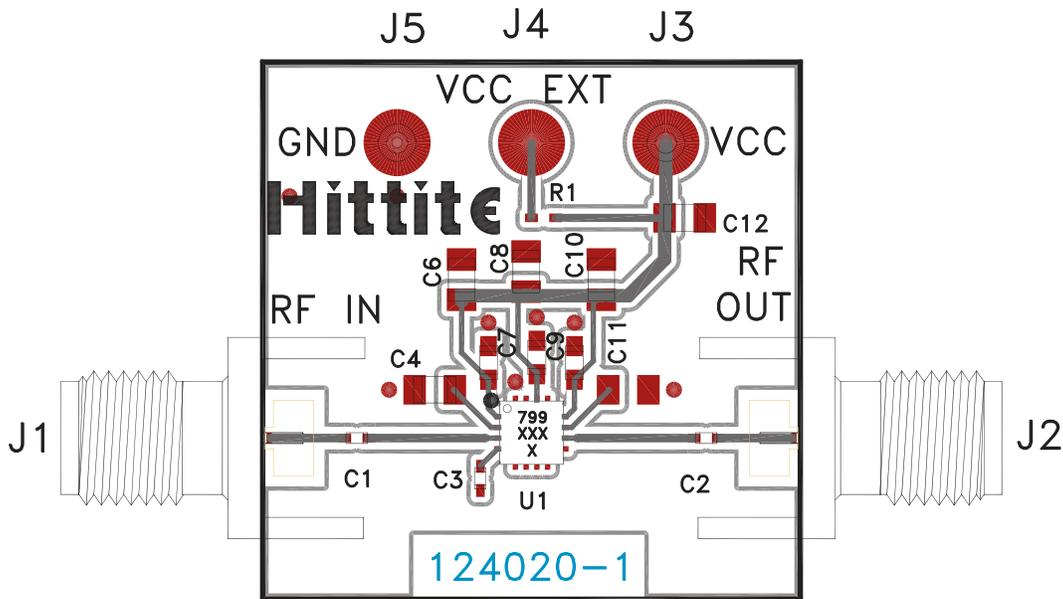

List of Materials for Evaluation PCB 124022 [1]

Item	Description
J1 - J2	PCB Mount SMA Connector
J3, J5	DC Pin
C1 - C3	22 nF Capacitor, 0402 Pkg.
C4, C12	10 μF Capacitor, 0805 Pkg.
C6, C8, C10	4.7 μF Capacitor, 0805 Pkg.
C7, C9, C11	0.1 μF Capacitor, 0603 Pkg.
U1	HMC799LP3E Transimpedance Amplifier
PCB [2]	124020 Evaluation PCB

[1] Reference this number when ordering complete evaluation PCB

[2] Circuit Board Material: Arlon 25FR or Rogers 4350

The circuit board used in the final application should use RF circuit design techniques. Signal lines should have 50 ohm impedance while the package ground leads and exposed paddle should be connected directly to the ground plane similar to that shown. A sufficient number of via holes should be used to connect the top and bottom ground planes. The evaluation circuit board shown is available from Hittite upon request.