

BAT24-02ELS

Single silicon Schottky diode



Order now



Technical documents



Simulation



Support

Product description

This Infineon RF Schottky diode is a silicon low barrier N-type device with an integrated guard ring-on chip for over-voltage protection. Its low barrier height, low forward voltage and low junction capacitance make BAT24-02ELS a suitable choice for mixer and detector functions in applications which frequencies are as high as 24 GHz.



Feature list

- Low inductance $L_S = 0.2$ nH (typical)
- Low capacitance $C = 0.2$ pF (typical) at voltage $V_R = 0$ V and frequency $f = 1$ MHz
- TSSLP-2-3 package (0.62 mm x 0.32 mm x 0.31 mm) with a 0201 foot print
- Pb-free, RoHS compliant and halogen free

Product validation

Qualified for industrial applications according to the relevant tests of JEDEC47/20/22.

Potential applications

For mixers and detectors in:

- Mobile devices
- Radar systems and modules

Device information

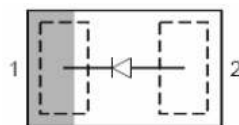

Table 1 Part information

Product name / Ordering code	Package	Pin configuration	Marking	Pieces / Reel
BAT24-02ELS / BAT2402ELSE6327XTSA1	TSSLP-2-3	Single, leadless	S underscore	15 k

Attention: ESD (Electrostatic discharge) sensitive device, observe handling precautions!

Table of contents

Table of contents

	Product description	1
	Feature list	1
	Product validation	1
	Potential applications	1
	Device information	1
	Table of contents	2
1	Absolute maximum ratings	2
2	Electrical performance in test fixture	3
2.1	Electrical characteristics	3
2.2	Characteristic curves	3
3	Thermal characteristics	7
4	Package information TSSLP-2-3	9
5	References	10
	Revision history	10
	Disclaimer	11

1 Absolute maximum ratings

Table 2 Absolute maximum ratings at $T_A = 25^\circ\text{C}$, unless otherwise specified

Parameter	Symbol	Values		Unit	Note or test condition
		Min.	Max.		
Diode reverse voltage	V_R	–	4	V	
Forward current	I_F	–	110	mA	
Total power dissipation	P_{TOT}	–	100	mW	$T_S \leq 82^\circ\text{C}$ ¹⁾
Junction temperature	T_J	–	150	°C	
Operating temperature	T_{OP}	-55	150		
Storage temperature	T_{STG}	-55	150		

Attention: *Stresses above the maximum values listed here may cause permanent damage to the device. Exposure to absolute maximum rating conditions for extended periods may affect device reliability. Exceeding only one of these values may cause irreversible damage to the component.*

¹ T_S is the soldering point temperature.

Electrical performance in test fixture

2 Electrical performance in test fixture

2.1 Electrical characteristics

Table 3 Electrical characteristics at $T_A = 25^\circ\text{C}$, unless otherwise specified

Parameter	Symbol	Values			Unit	Note or test condition
		Min.	Typ.	Max.		
Breakdown voltage	V_{BR}	4	–	–	V	$I_R = 10 \mu\text{A}$
Reverse current	I_R	–	–	5	μA	$V_R = 1 \text{ V}$
Forward voltage	V_R	0.16	0.25	0.32	V	$I_F = 1 \text{ mA}$
		0.25	0.35	0.41		$I_F = 10 \text{ mA}$
Differential forward resistance	R_F	–	8	10	Ω	$I_F = 10 \text{ mA} / 50 \text{ mA}$ ¹⁾
Capacitance	C	–	0.2	0.23	pF	$V_R = 0 \text{ V}, f = 1 \text{ MHz}$
Inductance	L_S	–	0.2	–	nH	

2.2 Characteristic curves

At $T_A = 25^\circ\text{C}$, unless otherwise specified

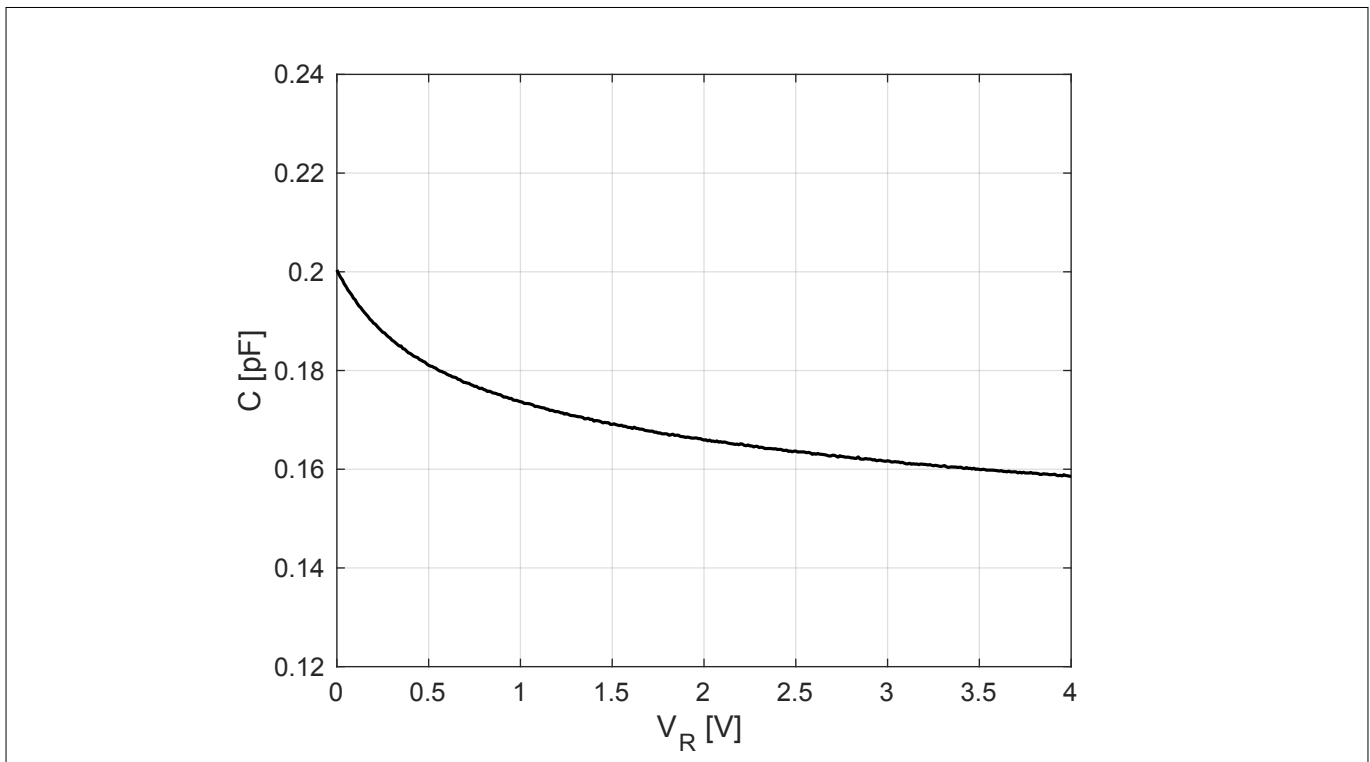

Figure 1 Capacitance C vs. reverse voltage V_R at frequency $f = 1 \text{ MHz}$

¹
$$R_F = \frac{V_F(50 \text{ mA}) - V_F(10 \text{ mA})}{50 \text{ mA} - 10 \text{ mA}}$$

Electrical performance in test fixture

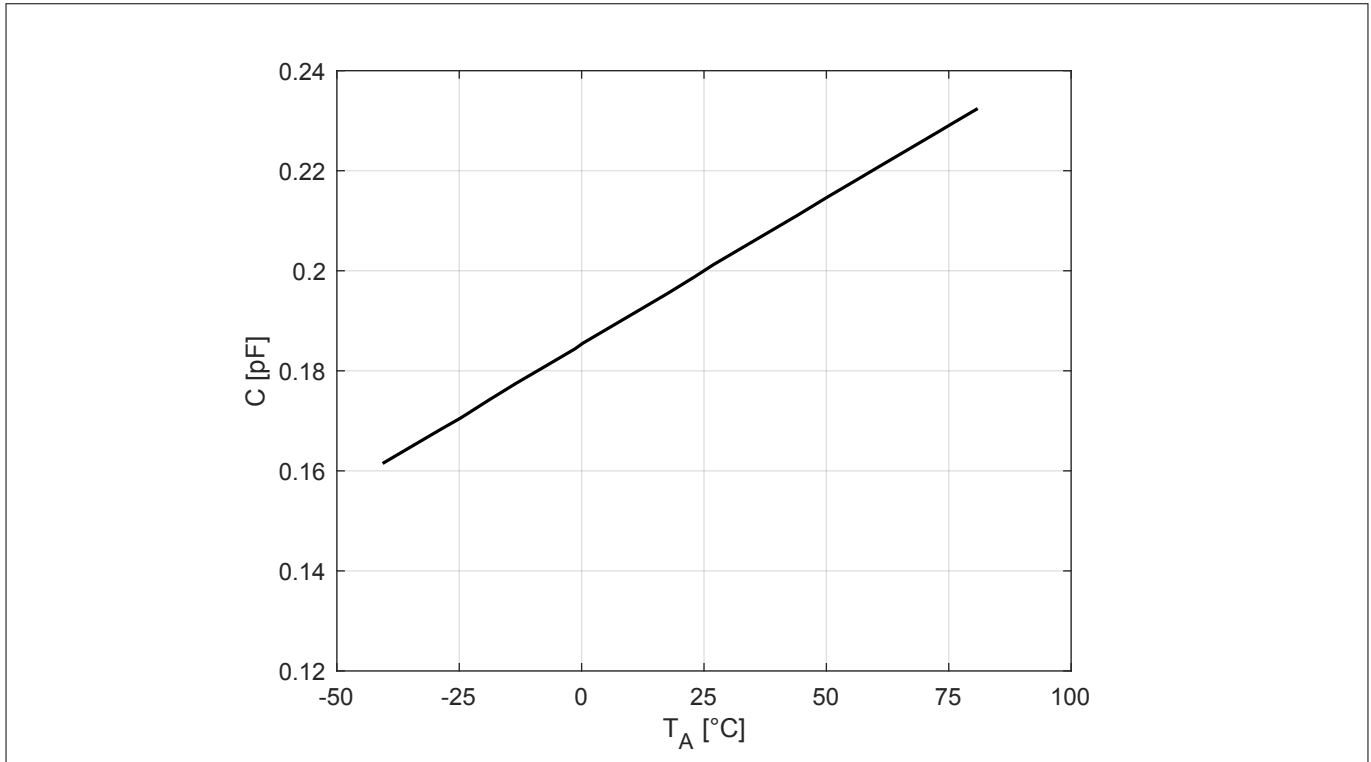

Figure 2 Capacitance C vs. ambient temperature T_A at frequency $f = 1$ MHz and reverse voltage $V_R = 0$ V

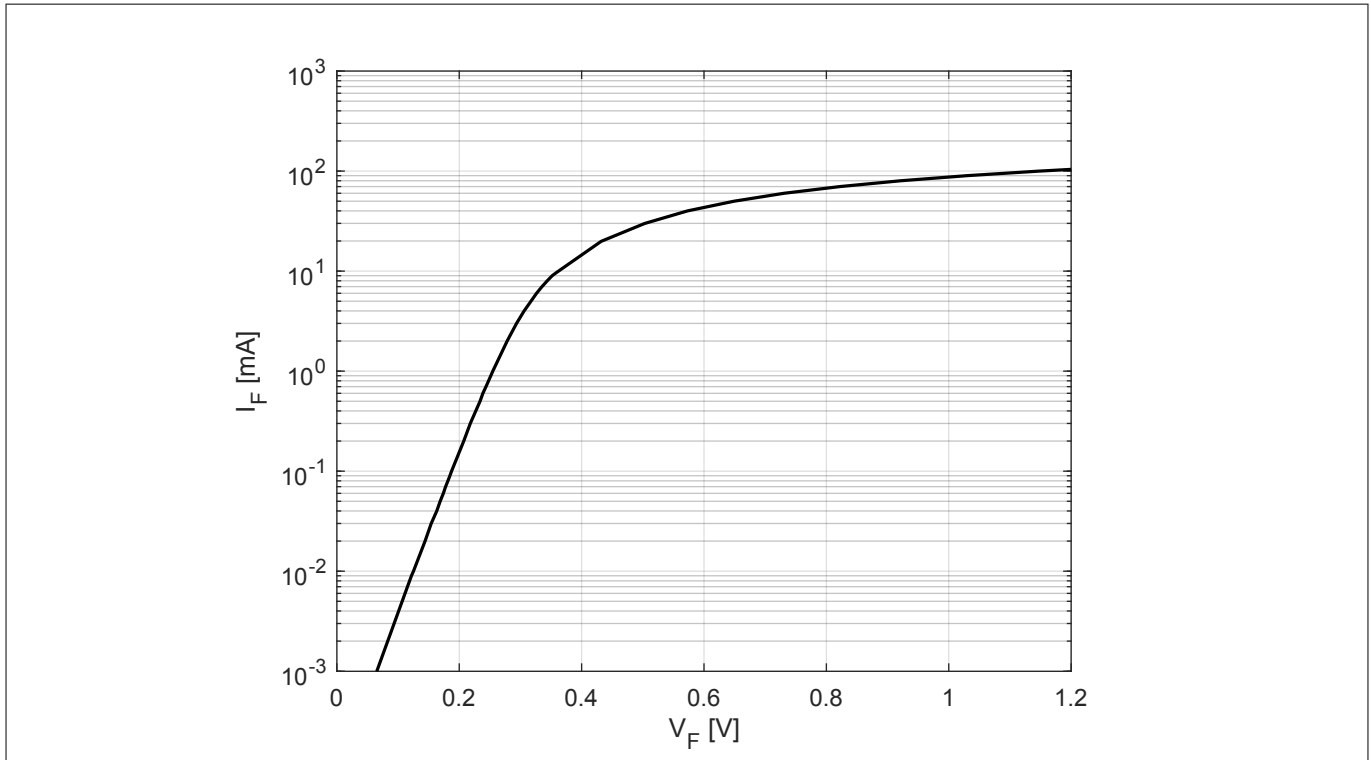

Figure 3 Forward current I_F vs. forward voltage V_F

Electrical performance in test fixture

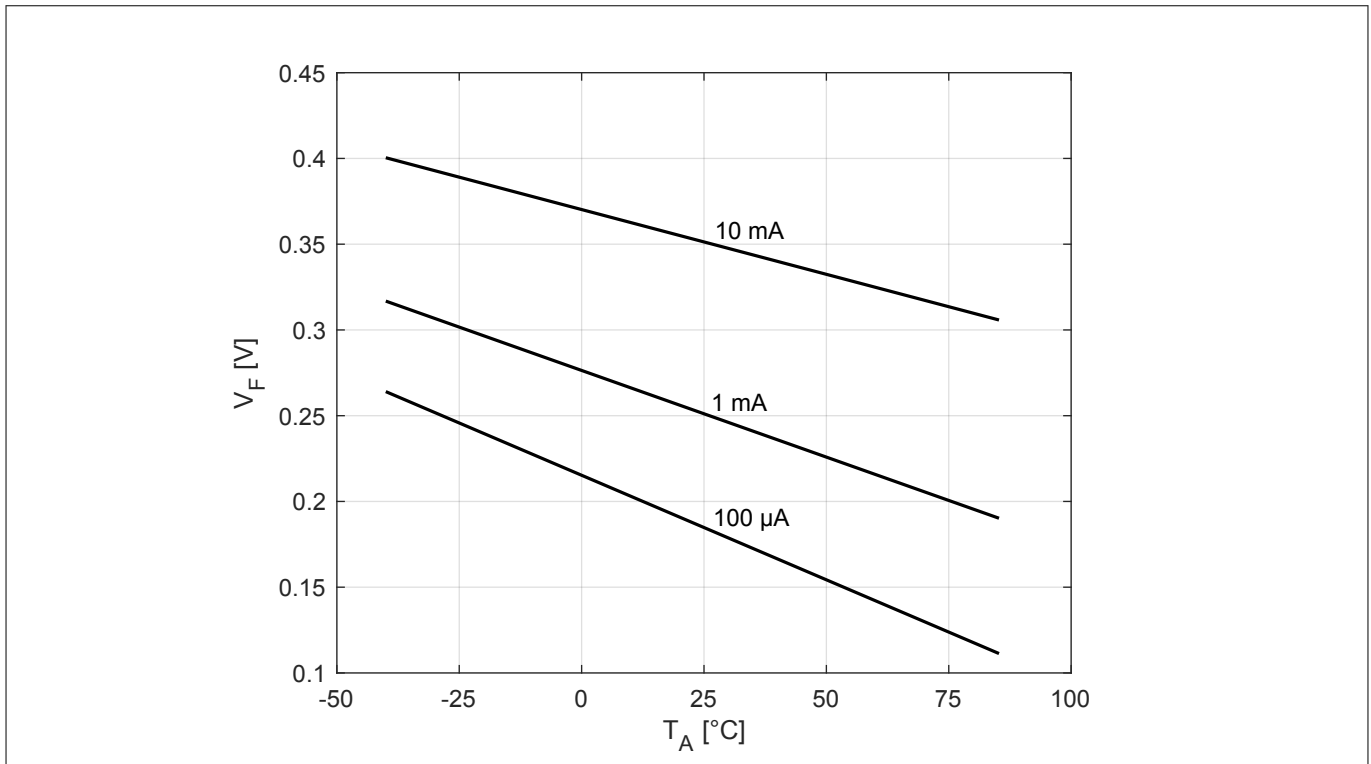

Figure 4 Forward voltage V_F vs. ambient temperature T_A at different forward currents

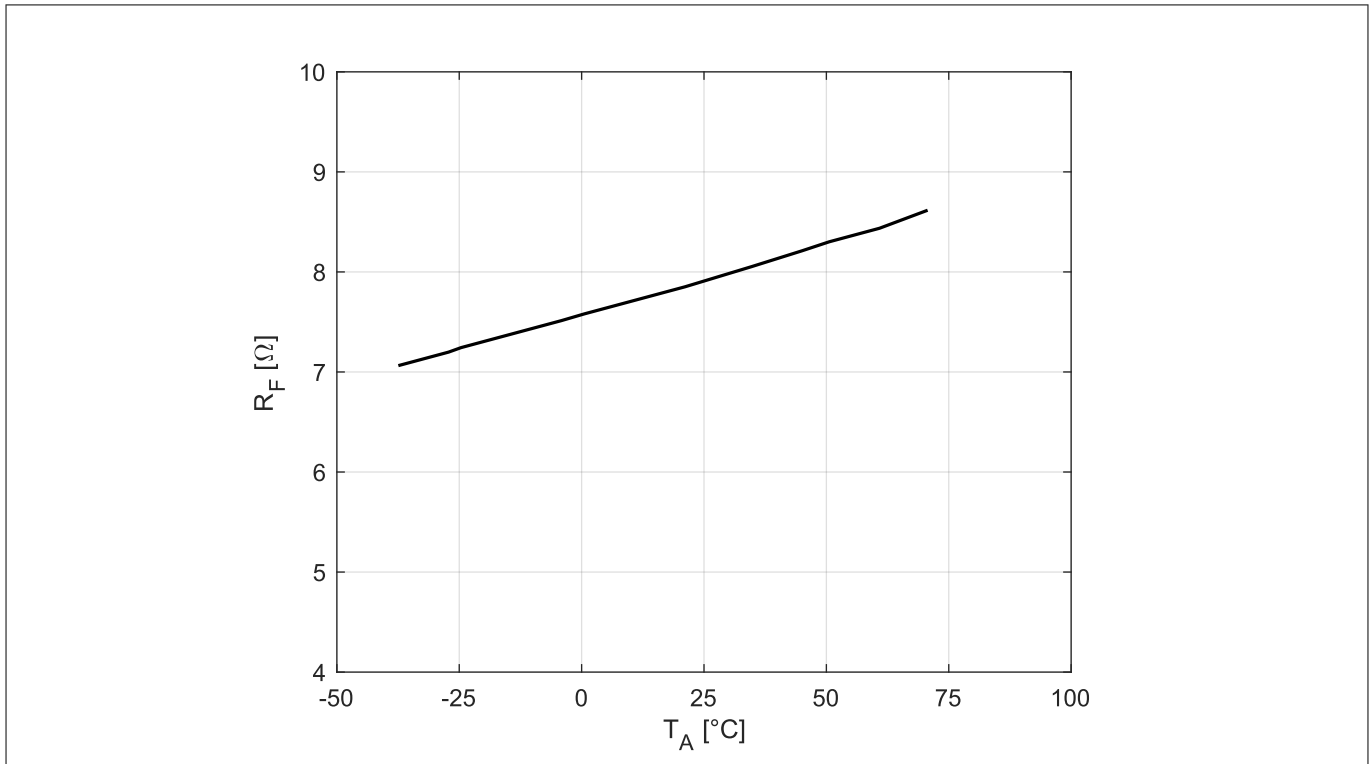

Figure 5 Differential forward resistance R_F vs. ambient temperature T_A between forward currents $I_F = 10$ mA and 50 mA

Electrical performance in test fixture

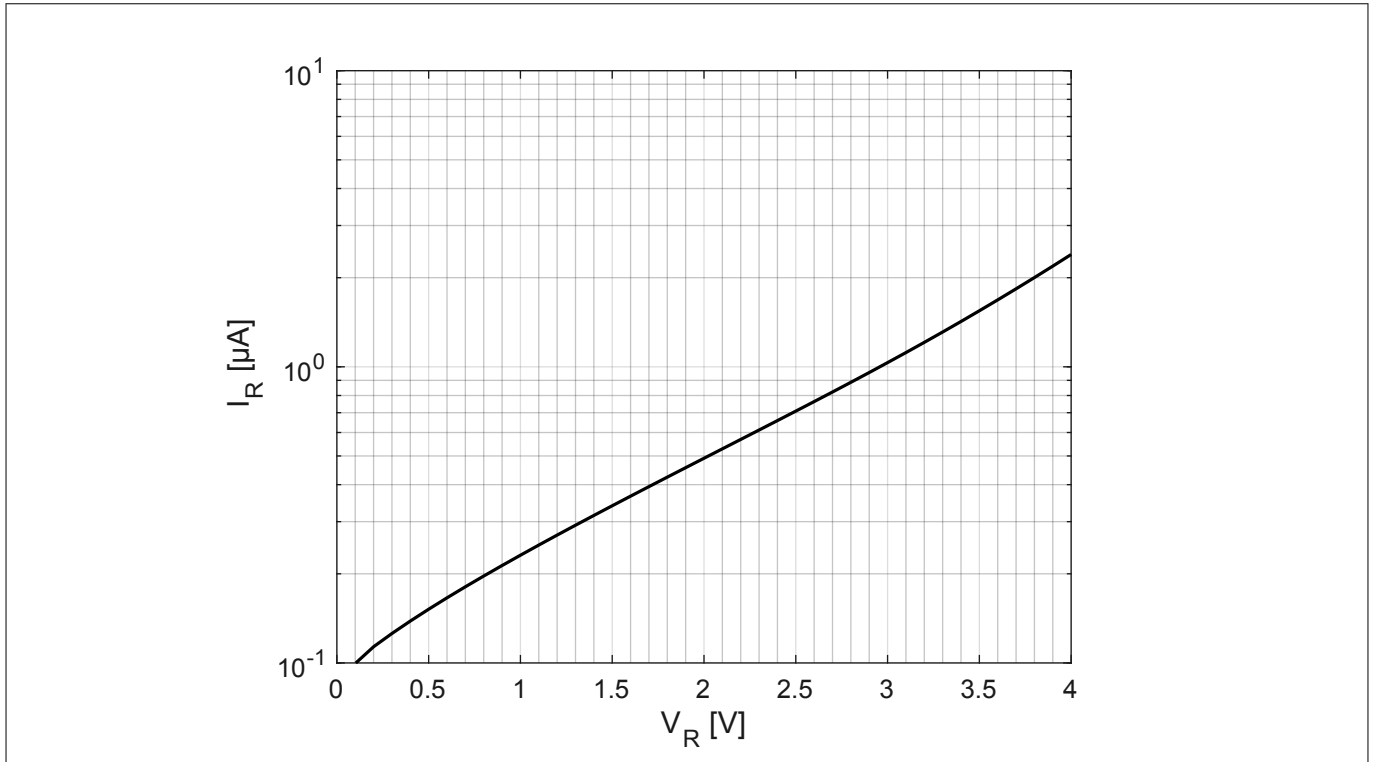

Figure 6 Reverse current I_R vs. reverse voltage V_R

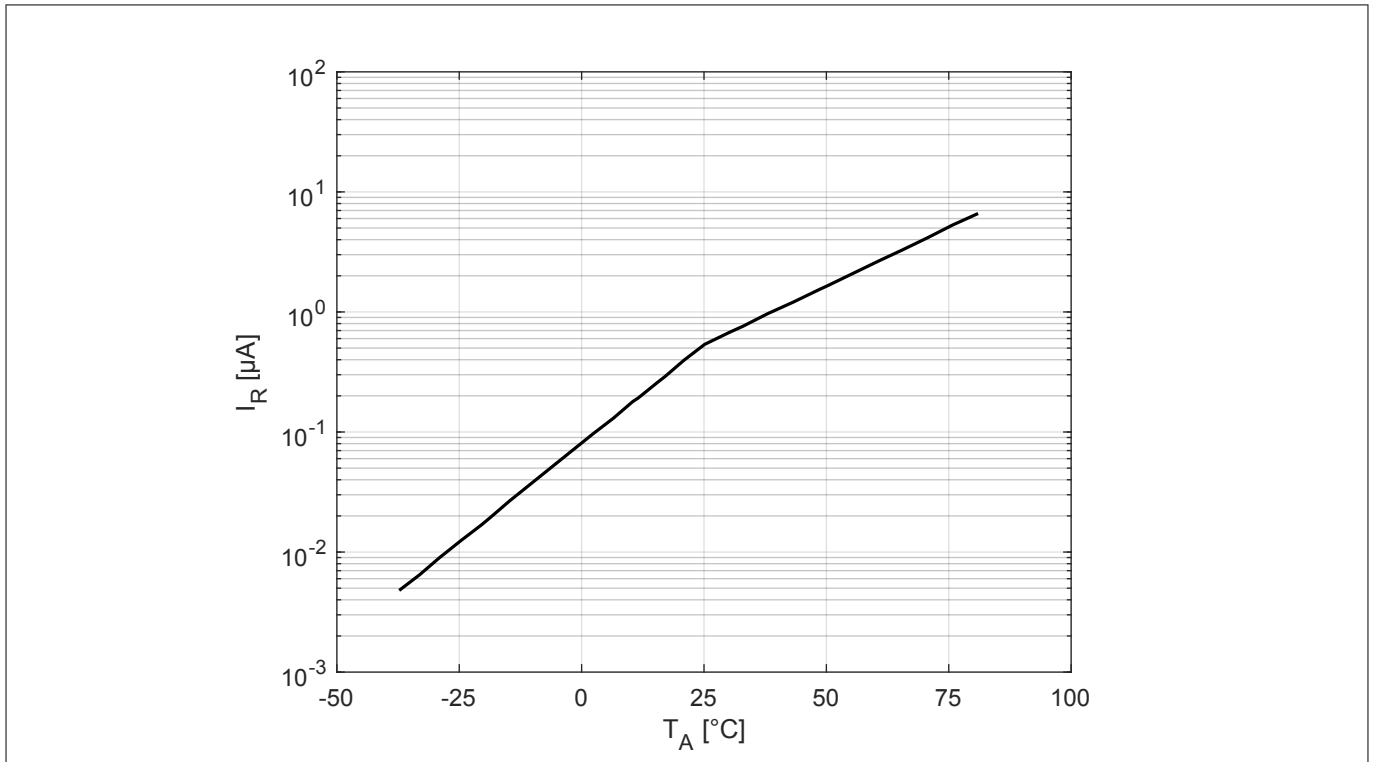

Figure 7 Reverse current I_R vs. ambient temperature T_A at reverse voltage $V_R = 1$ V

Note: The curves shown in this chapter have been generated using typical devices but shall not be understood as a guarantee that all devices have identical characteristic curves.

Thermal characteristics

3 Thermal characteristics

Table 4 Thermal resistance

Parameter	Symbol	Values			Unit	Note or test condition
		Min.	Typ.	Max.		
Thermal resistance (junction - soldering point)	R_{thJS}	-	675	-	K/W	$T_S = 82\text{ °C}$ ¹⁾

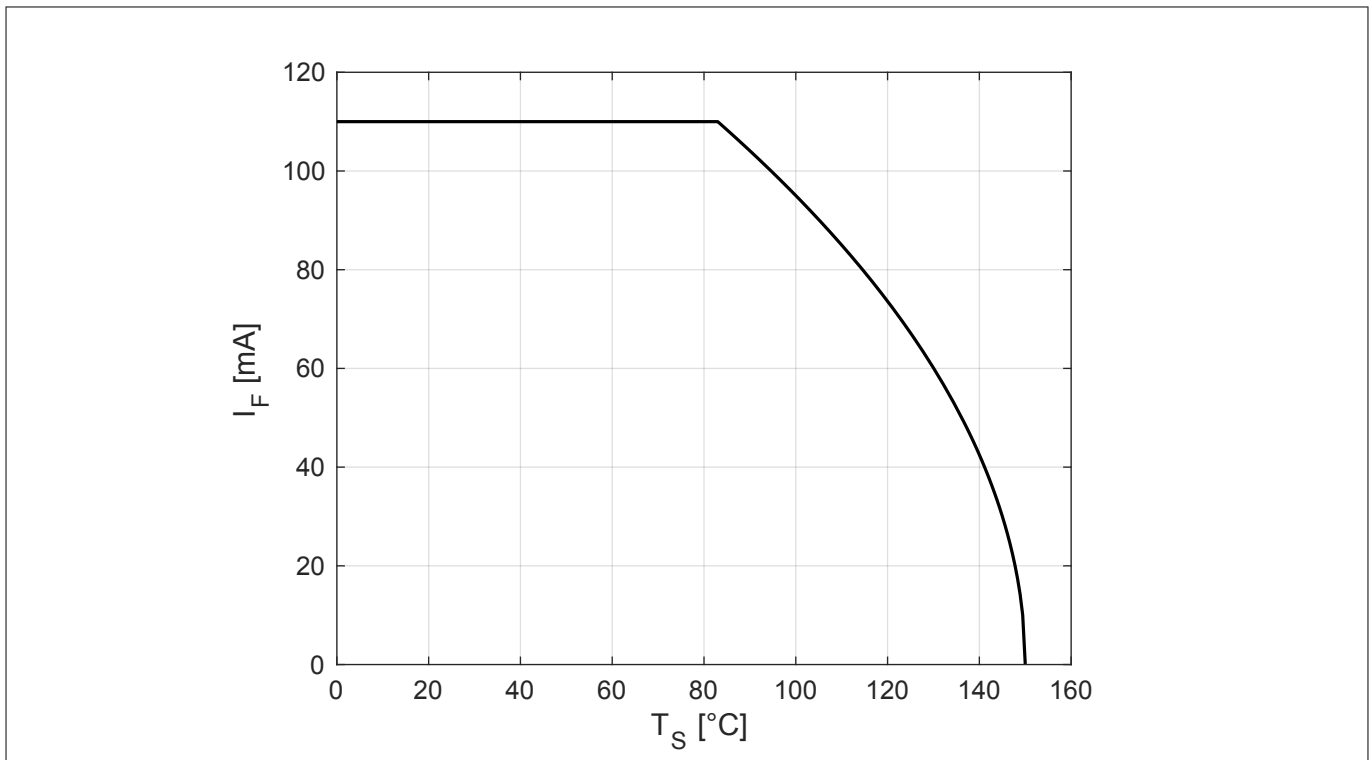

Figure 8 Permissible forward current I_F in DC operation

¹ For R_{thJS} in other conditions refer to the curves in this chapter.

Thermal characteristics

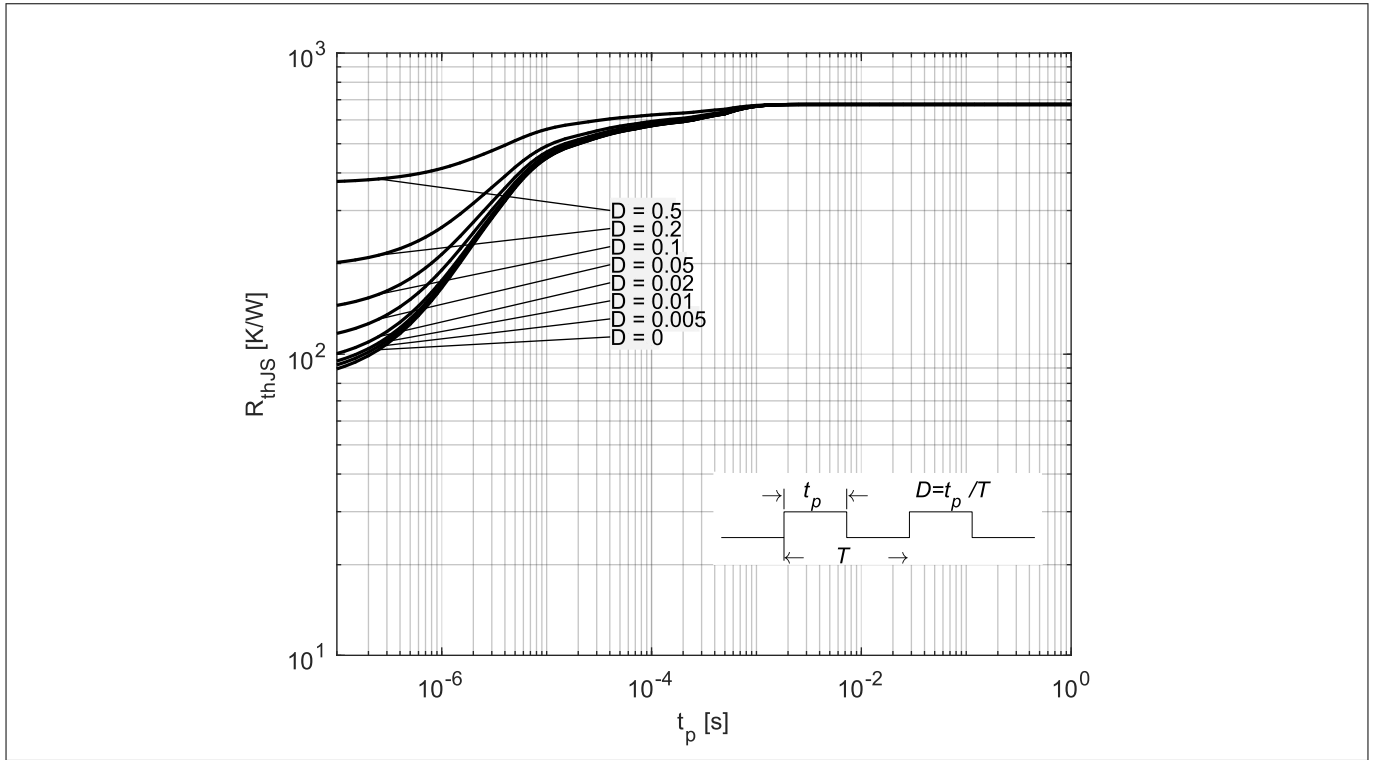

Figure 9 Thermal resistance R_{thJS} in pulse operation

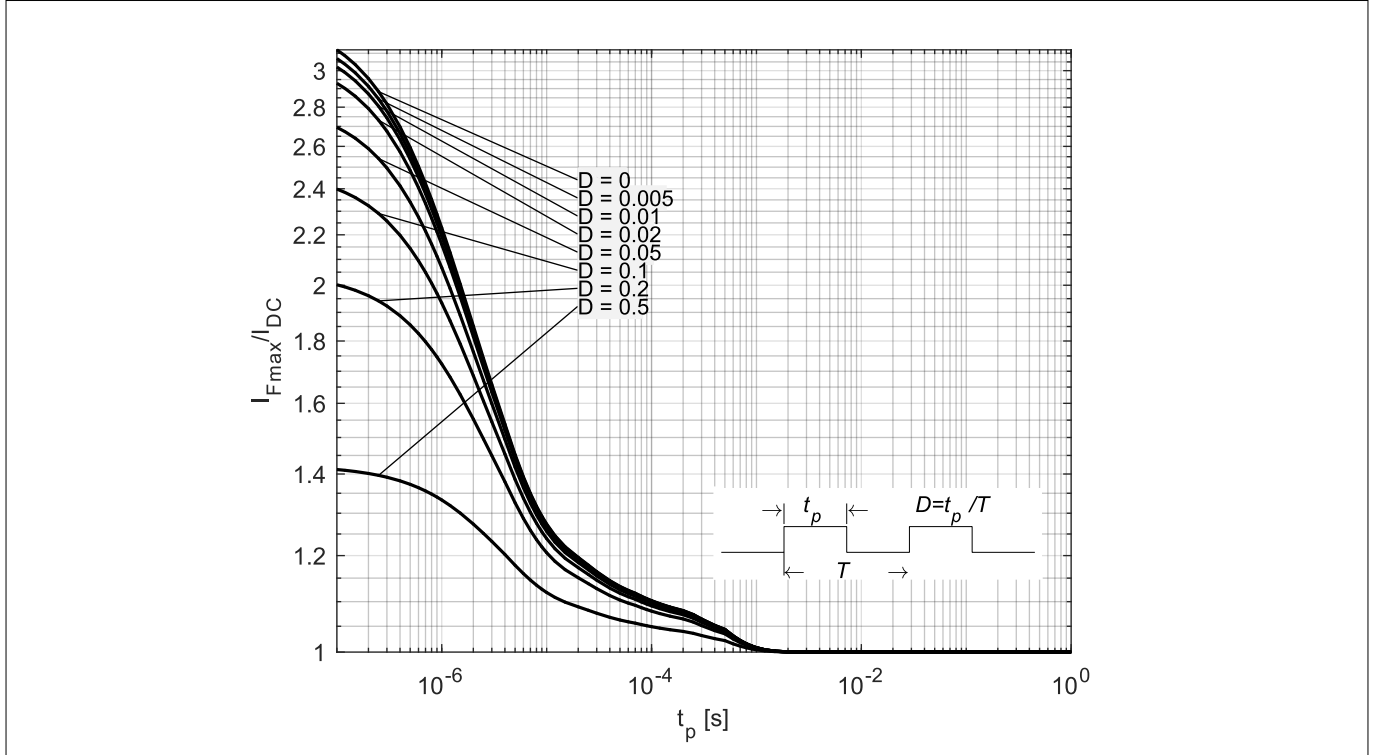

Figure 10 Permissible forward current ratio I_{Fmax}/I_{DC} in pulse operation

4 Package information TSSLP-2-3

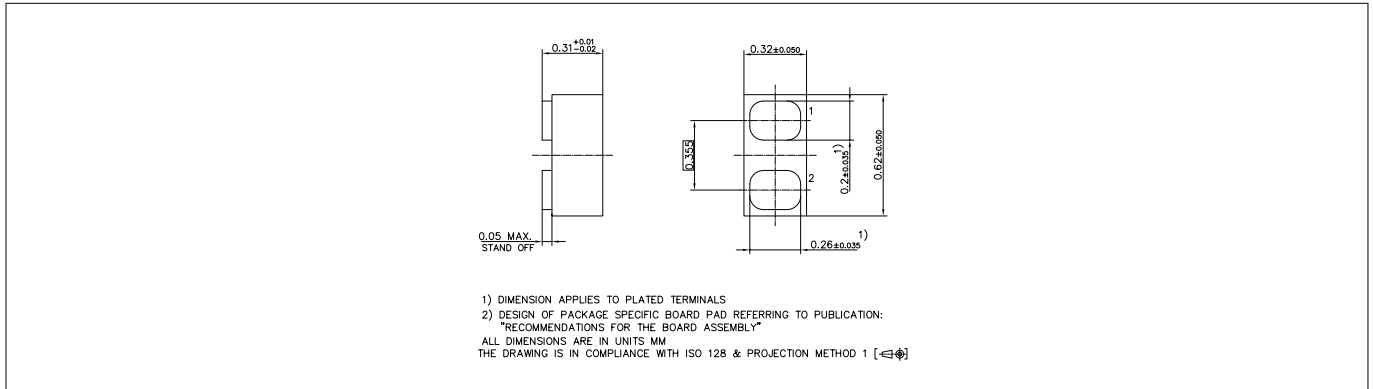

Figure 11 Package outline

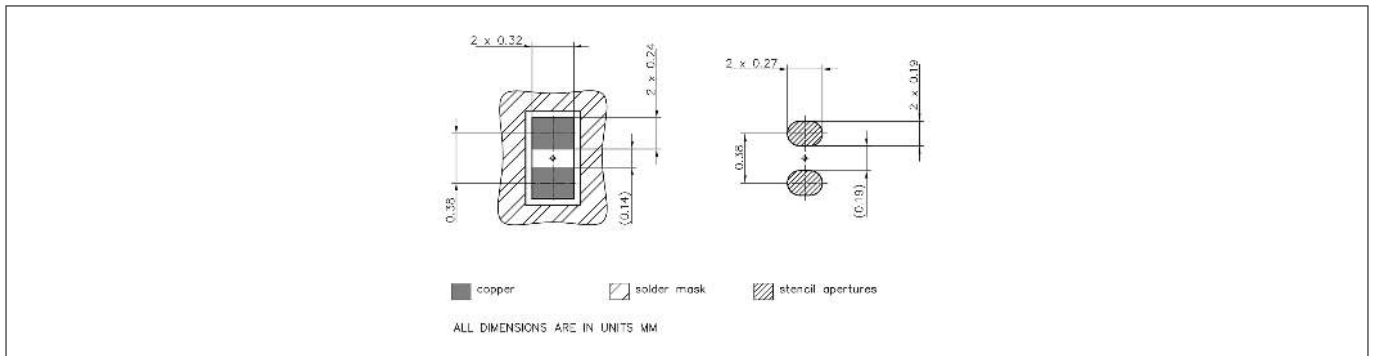

Figure 12 Foot print

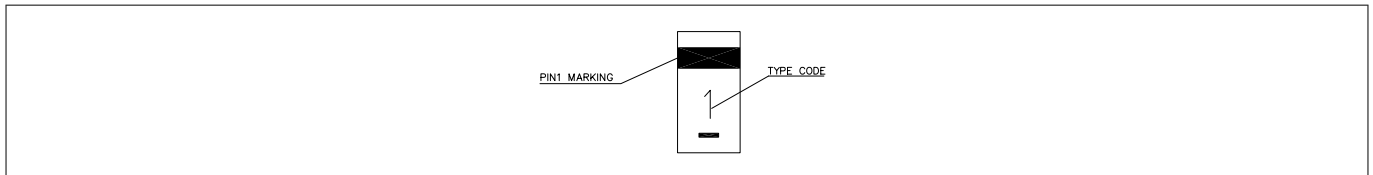

Figure 13 Marking layout example

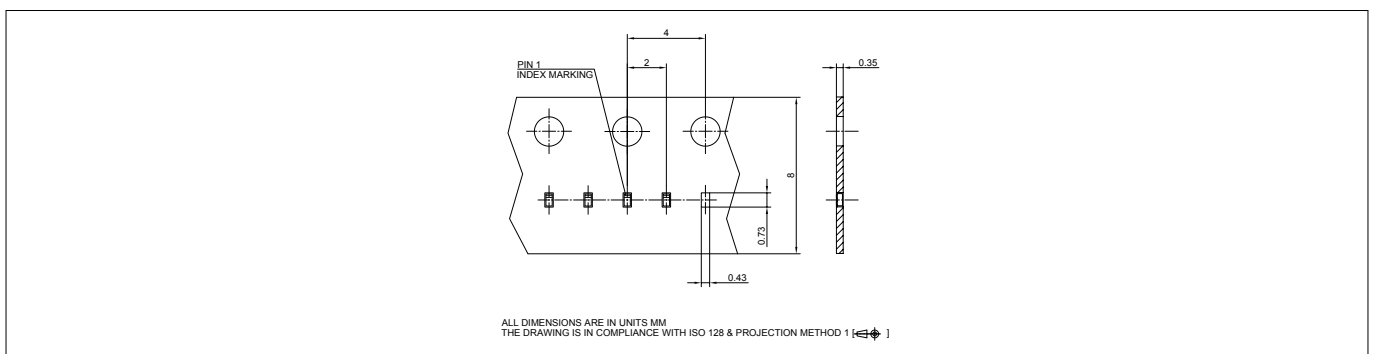

Figure 14 Tape dimensions

Note: See our [Recommendations for Printed Circuit Board Assembly of TSLP/TSSLP/TSNP Packages](#). The marking layout is an example. For the real marking code refer to the device information on the first page. The number of characters shown in the layout example is not necessarily the real one. The marking layout can consist of less characters.

References

5 References

[1]	Infineon AG - Recommendations for Printed Circuit Board Assembly of Infineon TSLP/TSSLP/TSNP Packages
-----	---

Revision history

Document version	Date of release	Description of changes
2.0	2018-09-07	<ul style="list-style-type: none">• New layout of datasheet• Typical values and curves updated to the values of the production (No product or process change behind)

Trademarks

All referenced product or service names and trademarks are the property of their respective owners.

Edition 2018-06-30

Published by
Infineon Technologies AG
81726 Munich, Germany

© 2018 Infineon Technologies AG
All Rights Reserved.

Do you have a question about any
aspect of this document?
Email: erratum@infineon.com

Document reference
IFX-qrj1529429594517

IMPORTANT NOTICE

The information given in this document shall in no event be regarded as a guarantee of conditions or characteristics ("Beschaffheitsgarantie").

With respect to any examples, hints or any typical values stated herein and/or any information regarding the application of the product, Infineon Technologies hereby disclaims any and all warranties and liabilities of any kind, including without limitation warranties of non-infringement of intellectual property rights of any third party.

In addition, any information given in this document is subject to customer's compliance with its obligations stated in this document and any applicable legal requirements, norms and standards concerning customer's products and any use of the product of Infineon Technologies in customer's applications.

The data contained in this document is exclusively intended for technically trained staff. It is the responsibility of customer's technical departments to evaluate the suitability of the product for the intended application and the completeness of the product information given in this document with respect to such application.

WARNINGS

Due to technical requirements products may contain dangerous substances. For information on the types in question please contact your nearest Infineon Technologies office.

Except as otherwise explicitly approved by Infineon Technologies in a written document signed by authorized representatives of Infineon Technologies, Infineon Technologies' products may not be used in any applications where a failure of the product or any consequences of the use thereof can reasonably be expected to result in personal injury