

THIS DRAWING IS UNPUBLISHED. VERTRAULICHE UNVERÖFFENTLICHTE ZEICHNUNG. RELEASED FOR PUBLICATION FREI FUER VERÖFFENTLICHUNG. 2000. MATED WITH: PASSEND ZU: 1355639. BY TYCO ELECTRONICS CORPORATION. ALL RIGHTS RESERVED. ALLE RECHTE VORBEHALTEN. COPYRIGHT 2000.

LOC	DIST	REVISIONS					
A	-	P	LTR	DESCRIPTION	DATE	DWN	APVD
PROJEKT NR.: 95-52384			A	New Drawing	31JAN100	ASC	JWO
			B	Locking latch improved	17APR2001	ASC	JWO
			BI	Spec number added	03NOV2003	SBL	ASC

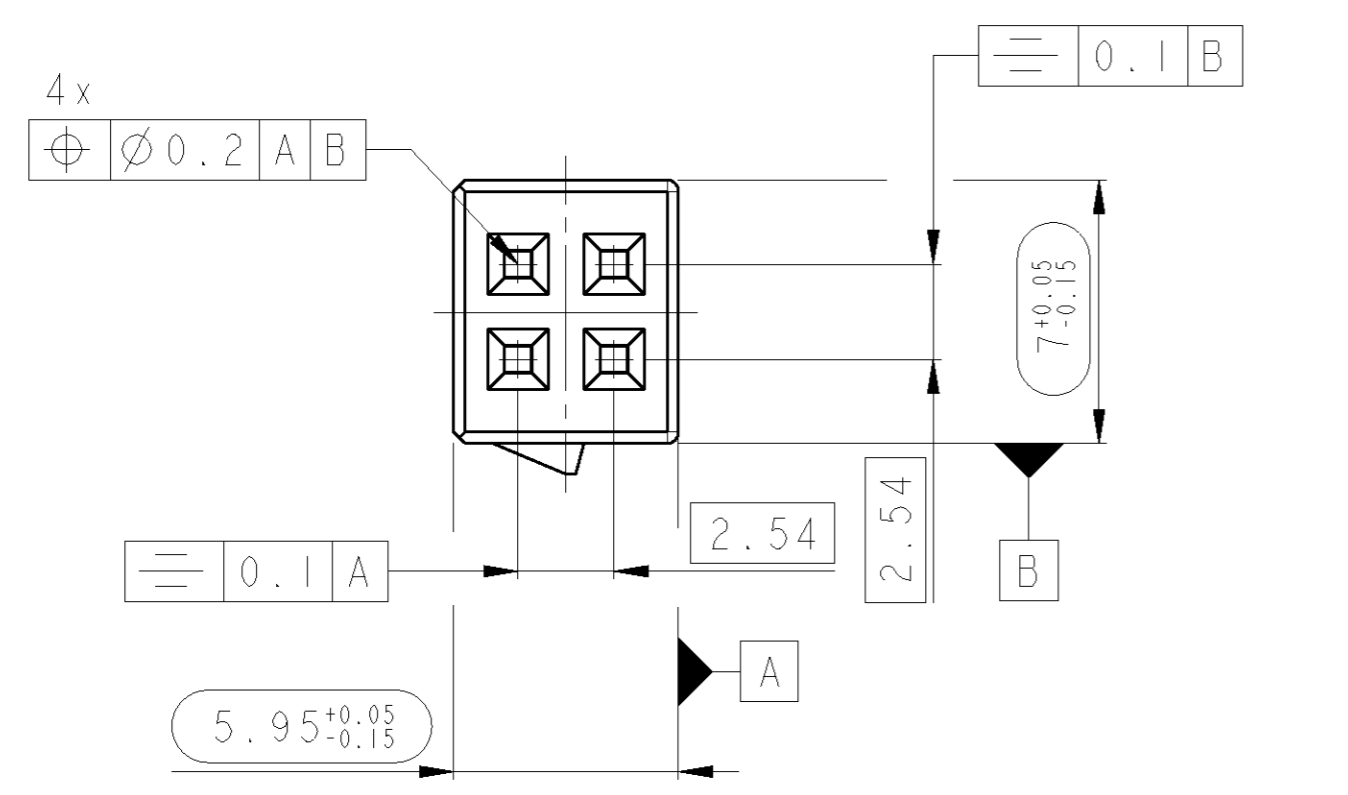

NOTES
Bemerkungen

1. ONLY THE GERMAN-LANGUAGE VERSION SHALL BE BINDING
Massgebend ist der deutsche Text
2. WIRE SIZE RANGE UNTIL 0,75mm²
Drahtgrössenbereich bis 0,75mm²
3. DETAILS OF DESIGN ARE LEFT TO MANUFACTURER
Einzelheiten der Ausführung bleiben dem Hersteller überlassen

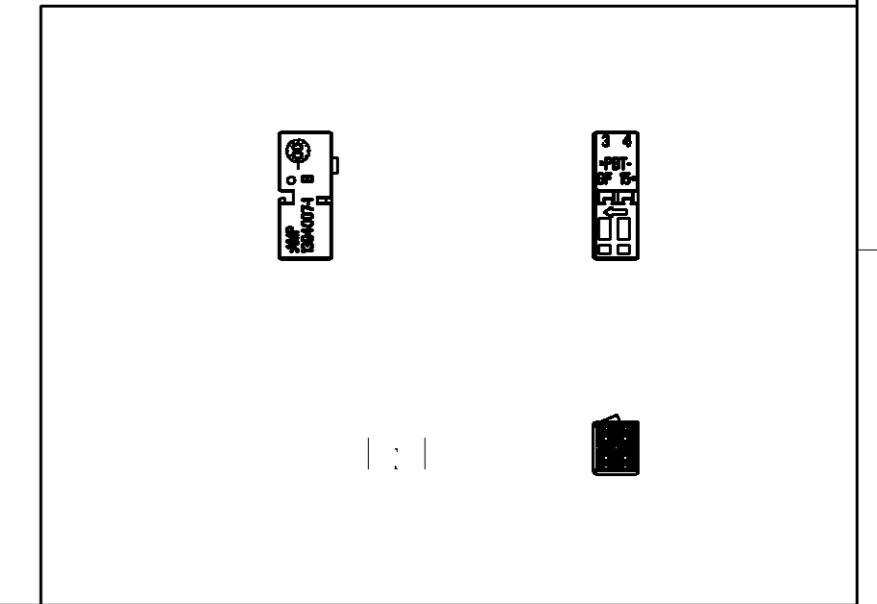
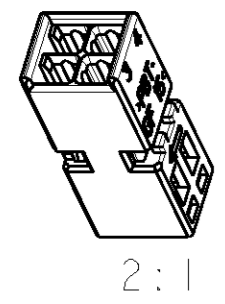
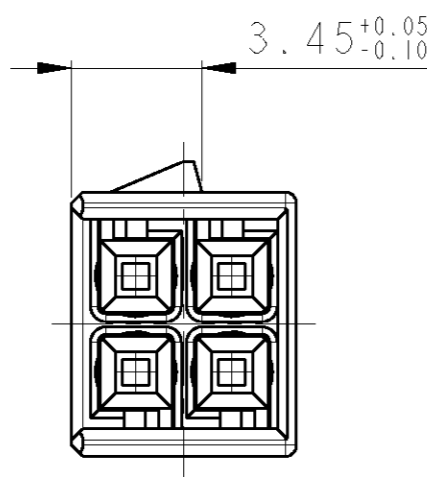
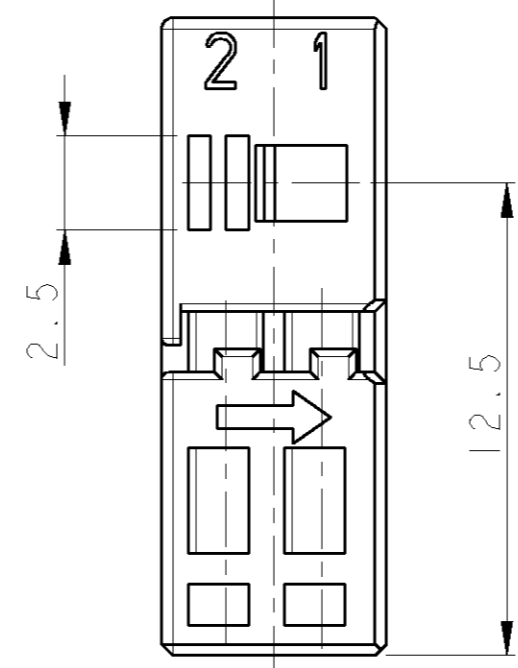
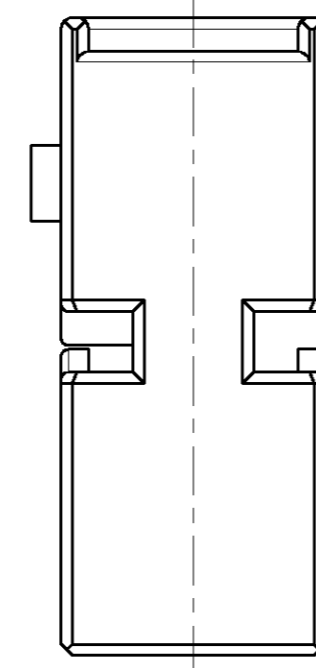
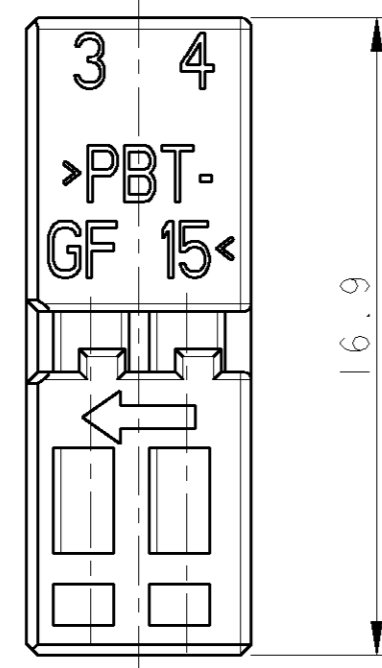
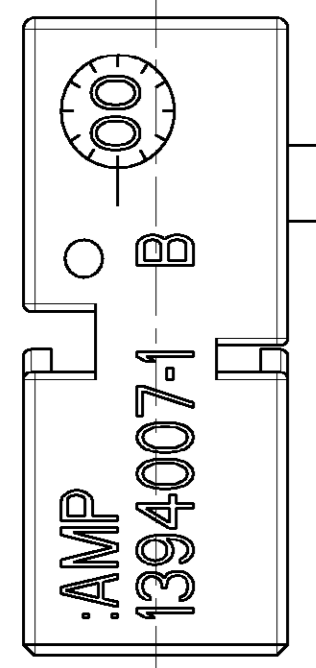

AMP PART NO.	REV.	MATERIAL	SURFACE COLOR	DESCRIPTION	ITEM NO.
1394007-1	B	PBT-GF15	schwarz/BLACK	SOCKET HOUSING	1

DIMENSIONS: MASSEINHEITEN: mm		TOLERANCES UNLESS OTHERWISE SPECIFIED: ALLGEMEINTOLERANZEN DIN 16901-140	
0 PLC	±	1 PLC	±
2 PLC	±	3 PLC	±
4 PLC	±	ANGLES/WINKEL	±°
FINISH/OBERFLAECHE/FARBE		PBT-GF15	

DWN	A. Schroebe	10JAN2000
CHK	J. Woller	10JAN2000
APVD	-	-
PRODUCT SPEC	108-18214	
APPLICATION SPEC	114-18351	
WEIGHT	0.47g	
CUSTOMER DRAWING / KUNDENZEICHNUNG		

tyco Electronics		tyco Electronics AMP GmbH D - 64625 Bensheim	
NAME: MOS Buchsengehaeuse, 4polig MOS SOCKET HOUSING, 4POS.			
SIZE	A2	CAGE CODE	00779
DRAWING NO. ZEICHNUNGS-NR.	C=1394007		RESTRICTED TO NUR FUER -
SCALE MASSSTAB	5:1	SHEET BLATT	OF VON
REV	BI		