

Mechanical Dimensions: Inches [mm]

Tolerances ± 0.012 [0.3] Unless Otherwise Specified

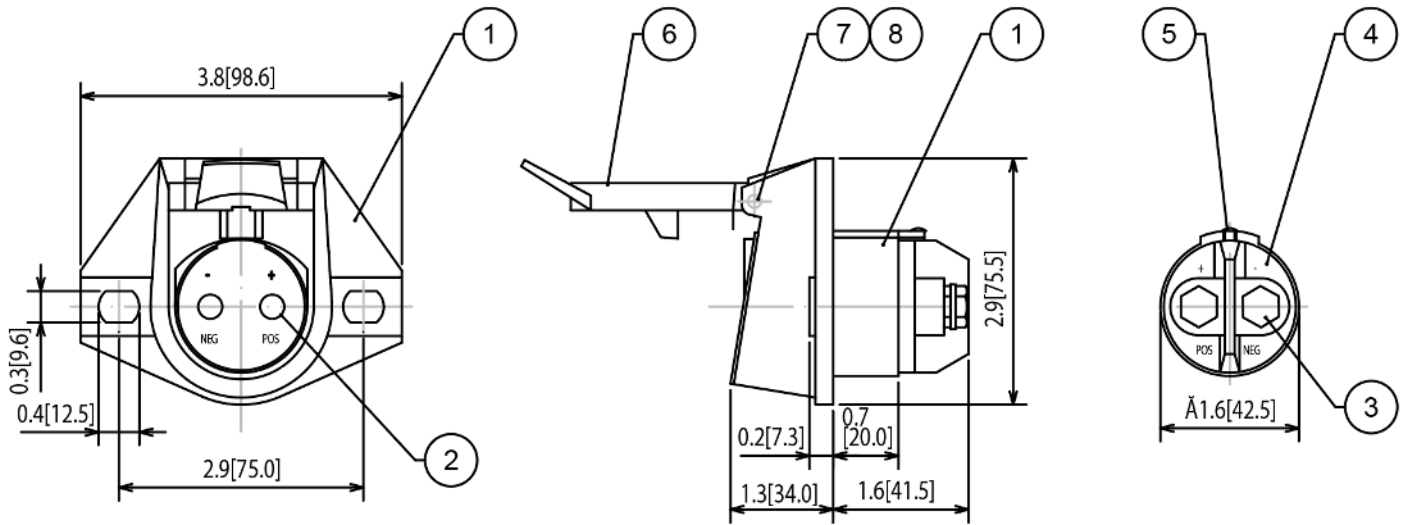

TOLERANCES:
 1mm~5mm:±0.1
 6mm~20mm:±0.2
 21mm~50mm:±0.3
 51mm~100mm:±0.5
 ANGLES:±1°

Material Specifications

ITEM#	NAME	MATERIAL
1	SOCKET SHELL	ZINC
2	TERMINALS	BRASS
3	TERMINAL SCREWS	STAINLESS STEEL
4	TERMINAL BASE	A.B.S
5	BASE SET SCREW	STAINLESS STEEL
6	COVER	ZINC
7	HINGE PIN	IRON
8	SPRING	STAINLESS STEEL

Rev	Date of issue	Revision Notes	Designed	Approved
A	07-16-2019	Initial Drawing	RC	OH