

# RE17LLBM

Harmony, Modular timing relay, 0.7 A, 1 s..100 h, asymmetrical flashing, solid state output, 24...240 V AC



## Main

Range of Product	Harmony Timer Relays
Product or Component Type	Dual function relay
Discrete output type	Solid state
Width	0.69 in (17.5 mm)
Component name	RE17L
Time delay type	Asymmetrical flashing
Time delay range	6...60 s 6...60 min 1...10 min 0.1...1 s 1...10 h 10...100 h 1...10 s
Nominal output current	0.7 A

## Complementary

Control type	Selector switch front panel
[Us] rated supply voltage	24...240 V AC 50/60 Hz
Voltage range	0.85...1.1 Us
Supply frequency	50...60 Hz +/- 5 %
Release of input voltage	7 V
Control signal pulse width	0.05 s typical
Insulation resistance	100 MOhm 500 V DC IEC 60664-1
[Uimp] rated impulse withstand voltage	5 kV 1.2/50 µs
Power on delay	100 ms
Connections - terminals	Screw terminals, 1 x 0.5...1 x 3.3 mm <sup>2</sup> AWG 20...AWG 12) solid without cable end Screw terminals, 2 x 0.5...2 x 2.5 mm <sup>2</sup> AWG 20...AWG 14) solid without cable end Screw terminals, 1 x 0.2...1 x 2.5 mm <sup>2</sup> AWG 24...AWG 14) flexible with cable end Screw terminals, 2 x 0.2...2 x 1.5 mm <sup>2</sup> AWG 24...AWG 16) flexible with cable end
Tightening torque	5.31...8.85 lbf.in (0.6...1 N.m) IEC 60947-1
Dielectric strength	2.5 kV 1 mA/1 minute 50 Hz IEC 61812-1
Housing material	Self-extinguishing
Repeat accuracy	+/- 0.5 % IEC 61812-1
Temperature Drift	+/- 0.05 %/°C
Voltage drift	+/- 0.2 %/V
Setting accuracy of time delay	+/- 10 % of full scale 25 °C IEC 61812-1
Reset time	350 ms on de-energisation typical
On-load factor	100 %
Power consumption in VA	0...3 VA 240 V AC
Breaking capacity	0.5 A AC UL 0.7 A AC 68 °F (20 °C)
Operating frequency	10 Hz
Maximum output current	20 A
Minimum switching current	10 mA
Maximum leakage current	5 mA
Maximum switching voltage	250 V AC

The information provided in this documentation contains general descriptions and/or technical characteristics of the performance of the products contained herein. This documentation is not intended as a substitute for and is not to be used for determining suitability or reliability of these products for specific user applications. It is the duty of any such user or integrator to perform the appropriate and complete risk analysis, evaluation and testing of the products with respect to the relevant specific application or use thereof. Neither Schneider Electric Industries SAS nor any of its affiliates or subsidiaries shall be responsible or liable for misuse of the information contained herein.

Maximum voltage drop	<4 V 3-wire <8 V 2-wire
Electrical durability	100000000 cycles
Marking	CE
Creepage distance	4 kV/3 IEC 60664-1
Safety reliability data	B10d = 320000 MTTFd = 353.8 years
Mounting position	Any position in relation to normal vertical mounting plane
Mounting support	35 mm DIN rail conforming to EN/IEC 60715
Net Weight	0.15 lb(US) (0.068 kg)
Time delay type	L, Li
Functionality	Asymmetrical flashing timer
Compatibility code	RE17

## Environment

Immunity to microbreaks	20 ms
Derating factor	5 mA/°C
Standards	EN 61000-6-2 EN 61000-6-4 IEC 61812-1 EN 61000-6-1 EN 61000-6-3 2006/95/EC 2004/108/EC
Product Certifications	CULus GL CSA
Ambient Air Temperature for Storage	-22...140 °F (-30...60 °C)
Ambient Air Temperature for Operation	-4...140 °F (-20...60 °C)
IP degree of protection	IP20 IEC 60529 terminal block) IP40 IEC 60529 housing) IP50 IEC 60529 front panel)
Vibration resistance	20 m/s <sup>2</sup> 10...150 Hz)IEC 60068-2-6
Shock resistance	15 gn 11 ms IEC 60068-2-27
Relative Humidity	93 % without condensation IEC 60068-2-30
Electromagnetic compatibility	Electrostatic discharge immunity test 6 kV in contact) level 3 IEC 61000-4-2 Electrostatic discharge immunity test 8 kV in air) level 3 IEC 61000-4-2 Susceptibility to electromagnetic fields 10 V/m 80 MHz to 1 GHz) level 3 IEC 61000-4-3 Electrical fast transient/burst immunity test 1 kV capacitive connecting clip) level 3 IEC 61000-4-4 Electrical fast transient/burst immunity test 2 kV direct) level 3 IEC 61000-4-4 1.2/50 µs shock waves immunity test 1 kV differential mode) level 3 IEC 61000-4-5 1.2/50 µs shock waves immunity test 2 kV common mode) level 3 IEC 61000-4-5 Conducted RF disturbances 10 V 0.15...80 MHz) level 3 IEC 61000-4-6 Voltage dips and interruptions immunity test 0 % 1 cycle) IEC 61000-4-11 Voltage dips and interruptions immunity test 70 % 25/30 cycles) IEC 61000-4-11 Conducted and radiated emissionsclass B EN 55022







## Ordering and shipping details

Category	22370-RE, RM MISC TIMERS & COUNTERS
Discount Schedule	CP2
GTIN	3606480552656
Nbr. of units in pkg.	1
Package weight(Lbs)	2.57 oz (73.0 g)
Returnability	No
Country of origin	ID

## Packing Units

Unit Type of Package 1	PCE
Package 1 Height	1.06 in (2.7 cm)
Package 1 width	3.15 in (8 cm)
Package 1 Length	3.74 in (9.5 cm)
Unit Type of Package 2	S02
Number of Units in Package 2	40
Package 2 Weight	7.38 lb(US) (3.347 kg)
Package 2 Height	5.91 in (15 cm)
Package 2 width	11.81 in (30 cm)
Package 2 Length	15.75 in (40 cm)

## Offer Sustainability

Sustainable offer status	Green Premium product
California proposition 65	WARNING: This product can expose you to chemicals including: Lead and lead compounds, which is known to the State of California to cause cancer and birth defects or other reproductive harm. For more information go to <a href="http://www.P65Warnings.ca.gov">www.P65Warnings.ca.gov</a>
REACH Regulation	 <a href="#">REACH Declaration</a>
EU RoHS Directive	Pro-active compliance (Product out of EU RoHS legal scope)  <a href="#">EU RoHS Declaration</a>
Mercury free	Yes
RoHS exemption information	 <a href="#">Yes</a>
China RoHS Regulation	 <a href="#">China RoHS Declaration</a>
Environmental Disclosure	 <a href="#">Product Environmental Profile</a>
Circularity Profile	 <a href="#">End Of Life Information</a>

Width 17.5 mm

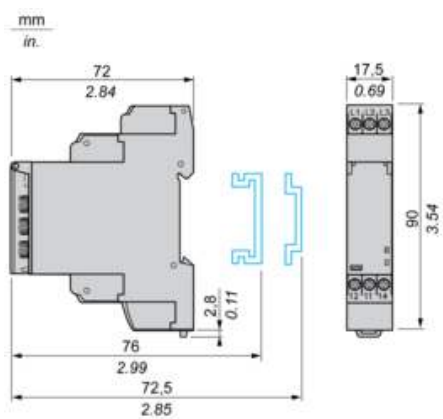

## Internal Wiring Diagram

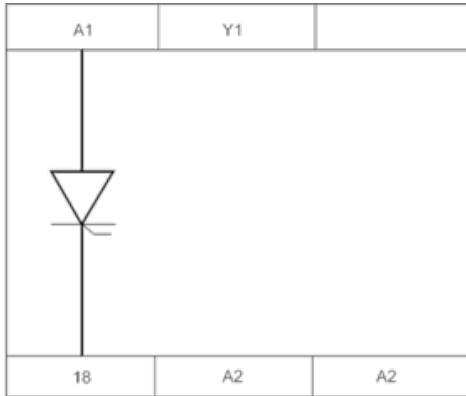

## Wiring Diagram

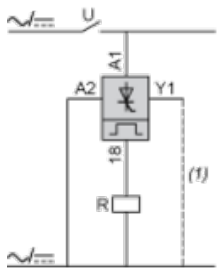

1 Link A2-Y1 for function L only.

Function L : Asymmetrical Flasher Relay (Starting Pulse Off)

Description

Repetitive cycle comprises of two, independently adjustable timing periods  $T_a$  and  $T_r$ . Each timing period corresponds to a different state of the output R.

Function: 1 Output



Function Li : Asymmetrical Flasher Relay (Starting Pulse On)

Description

Repetitive cycle comprises of two, independently adjustable timing periods  $T_a$  and  $T_r$ . Each timing period corresponds to a different state of the output R.

Function: 1 Output



Legend

Relay de-energised

Relay energised

 Output open

 Output closed

C	Control contact
G	Gate
R	Relay or solid state output
R1/R2	2 timed outputs
R2 inst.	The second output is instantaneous if the right position is selected
T	Timing period
$T_a$ -	Adjustable On-delay
$T_r$ -	Adjustable Off-delay
U	Supply