

# CapSense Matrix Button Keypad

## User Manual

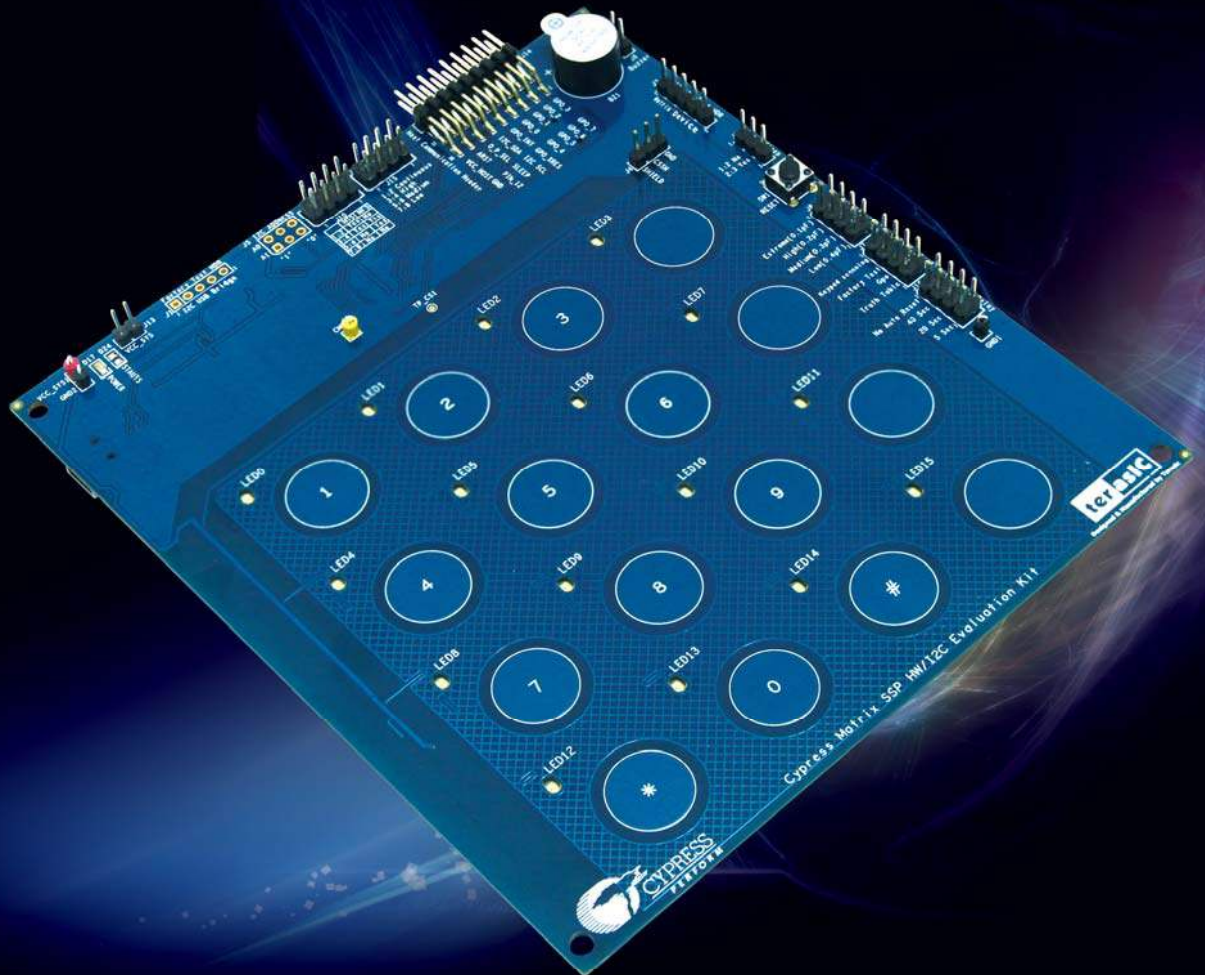

<b>CHAPTER 1</b>	<b><i>INTRODUCTION OF THE CAPSENSE MATRIX BUTTON KEYPAD BOARD.....</i></b>	<b>2</b>
1.1	FEATURES.....	2
1.2	ABOUT THE KIT .....	4
1.3	GETTING HELP .....	5
<b>CHAPTER 2</b>	<b><i>CAPSENSE MATRIX BUTTON KEYPAD ARCHITECTURE .....</i></b>	<b>6</b>
2.1	Layout and Components.....	6
2.2	Block Diagram of the CapSense Matrix Button Keypad .....	7
2.3	Power-up the CapSense Matrix Button Keypad.....	8
2.4	Default Switch and Jumper Settings .....	9
<b>CHAPTER 3</b>	<b><i>USING THE CAPSENSE MATRIX BUTTON KEYPAD.....</i></b>	<b>11</b>
3.1	User Input/Output.....	11
3.2	GPO Header .....	15
3.3	Power Supply .....	16
<b>CHAPTER 4</b>	<b><i>PROJECT EXAMPLES .....</i></b>	<b>17</b>
4.1	System Requirements.....	17
4.2	LEDs .....	17
4.3	Firmware Functionality .....	18
<b>CHAPTER 5</b>	<b><i>APPENDIX .....</i></b>	<b>20</b>
5.1	Revision History.....	20
5.2	Copyright Statement.....	20

# *Introduction of the CapSense Matrix Button Keypad Board*

The CapSense Matrix Button Keypad board is designed to allow users to easily implement a matrix keypad user interface solution using Cypress CapSense/SmartSense technology. The board contains 16 capacitive touch buttons organized in a matrix style format. The board will enable users to achieve quick-to-market designs in large solution applications such as fire alarm control panels, security systems, and door locks.

### 1.1 Features

**Figure 1-1** shows a photograph of the CapSense Matrix Button Keypad Board.

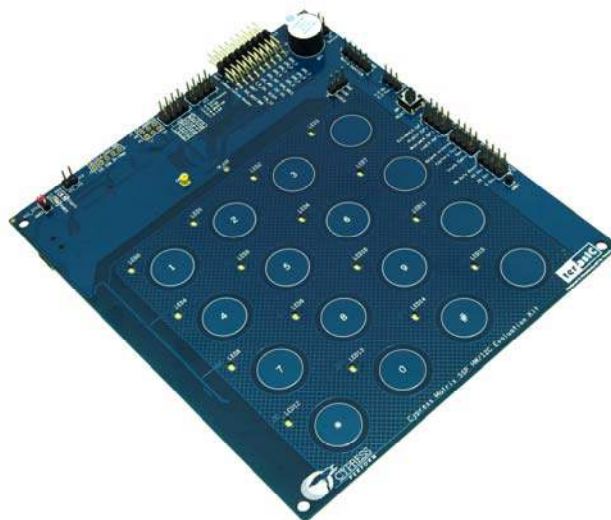

**Figure 1-1** Layout of the CapSense Matrix Button Keypad Board



The key features of the board are listed below:

- 4x4 Matrix Solution
  - Utilizes Cypress's industry leading CapSense Technology with SmartSense
  - Simultaneous key press enabled
  - Mechanical matrix interface enabled for backwards compatibility
- SmartSense Enabled
  - Auto-Tuning for PCB manufacturing variances
  - Adaptive Threshold Auto-Tuning for different overlays
  - SNR Optimization to obtain robust performance
- Configurable Solution
  - Pin configurable buttons
- Featured device
  - CY8CMBR2016 CapSense Express Device
- Expansion header
  - GPO Host Communication Header
- Audio
  - Buzzer included for feedback
- Switches and indicators
  - 16 LEDs
  - 1 Reset Push-button Switch
- Connectors
  - USB Type mini-AB Port
- System Ready
  - BOM included
  - Layout/Gerber files included

## 1.2 About the KIT

- The kit will come with the following contents:
  - Cypress CapSense Matrix Button Keypad Board
  - Portable Battery-powered USB Charger (AA battery type)
  - USB A to Mini-B Cable
  - Acrylic Board (3mm and 1.5mm)
  - Quick Start Guide
  - System CD

Figure 1-2 shows the photograph of the Cypress CapSense Matrix Button Keypad kit content.

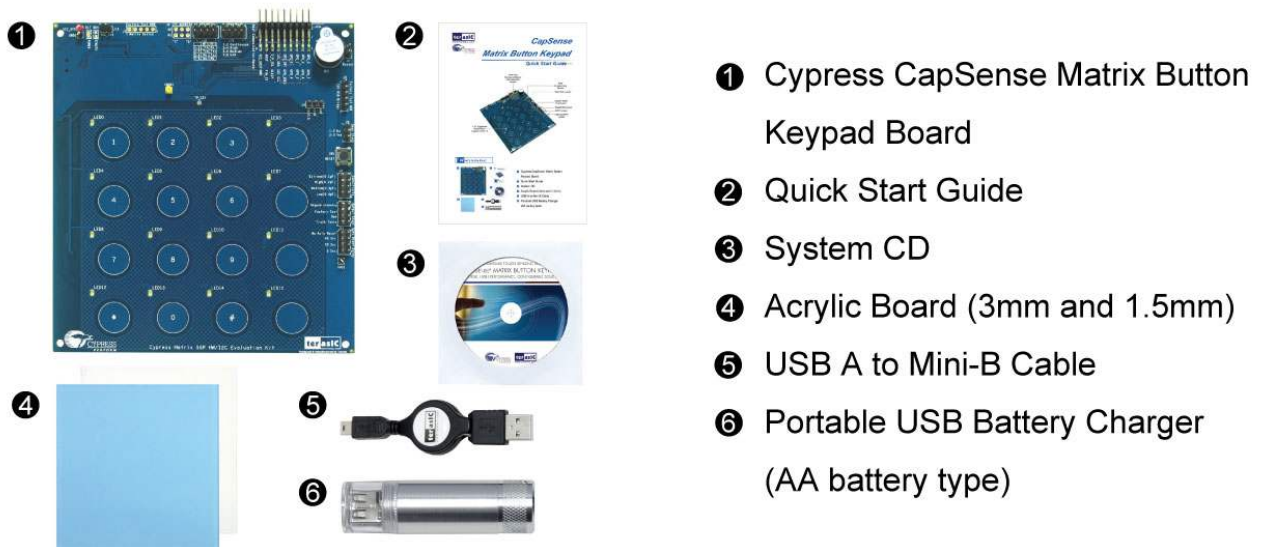

Figure 1-2 CapSense Matrix Button Keypad kit Package Contents



## 1.3 Getting Help

Here is information of how to get help if you encounter any problem:

- Cypress Semiconductor
- Tel: +1(800)541-4736 Ext.8(in the USA) / +1(408)943-2600 Ext.8(International)
- Support Link: [www.cypress.com/go/support](http://www.cypress.com/go/support)

Terasic Technologies provides design consulting services to customers in electronic system development to help accelerate their system from design to production. Please contact us below for more info:

- Terasic Technologies
- Tel: +886-3-550-8800 (China and Taiwan)
- Email: [cysupport@terasic.com](mailto:cysupport@terasic.com)

## Chapter 2

# CapSense Matrix Button Keypad

## Architecture

This chapter describes the architecture of the CapSense Matrix Button Keypad board including block diagram and components.

### 2.1 Layout and Components

The picture of the CapSense Matrix Button Keypad board is shown in **Figure 2-1** and **Figure 2-2**. It depicts the layout of the board and indicates the locations of the connectors and key components.

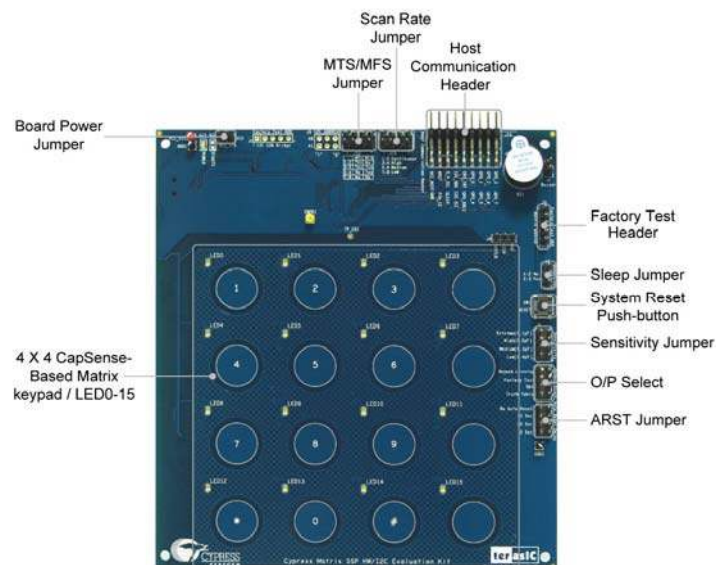

**Figure 2-1** The CapSense Matrix Button Keypad PCB and Component Diagram (top view)

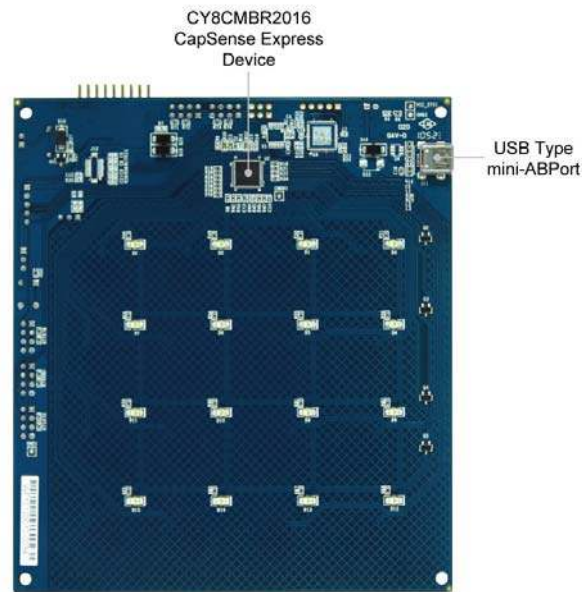

**Figure 2-2 The CapSense Matrix Button Keypad PCB and Component Diagram (bottom view)**

Note: For jumper setting and description, please refer to Section 2.4.

## 2.2 Block Diagram of the CapSense Matrix Button Keypad

**Figure 2-3** shows the block diagram of the CapSense Matrix Button Keypad.



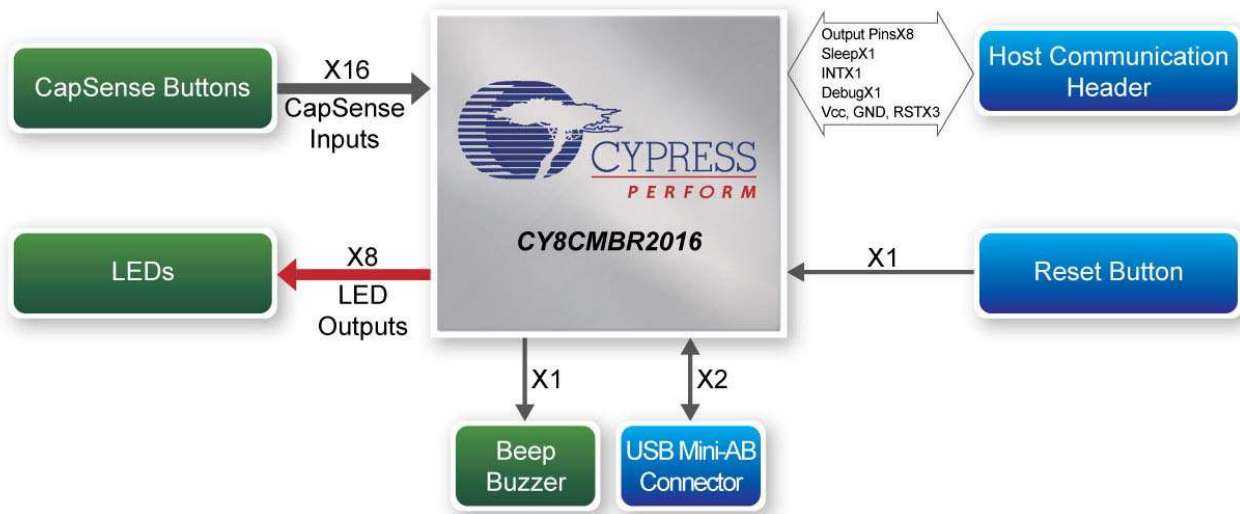

Figure 2-3 Block Diagram of CapSense Matrix Button Keypad

## 2.3 Power-up the CapSense Matrix Button Keypad

The CapSense Matrix Button Keypad comes with a preloaded factory configuration to demonstrate the features of the board. The factory configurations allow users to see quickly if the board is working properly. To power-up the board:

1. Connect the USB A to Mini-B cable to a USB (Type A) host port and to the board. The power LED (D17) should immediately turn on. Alternatively, the board can be powered on by connecting the board using the portable battery-powered USB connector.





Note: Users can also power-on the board by connecting a MiniProg Programming unit to the ISSP Programming header.

2. Touch the CapSense button as the corresponding LED will glow indicating which button you are touching. Also, a buzzer sound will activate whenever a button is pressed.

## 2.4 Default Switch and Jumper Settings

**Table 2-1** describes the default jumper settings on the CapSense Matrix Button Keypad board and its description.

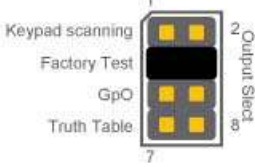
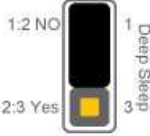
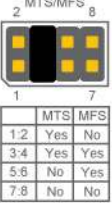
**Table 2-1 Default Jumper Setting and Description**

Jumper	Default Setting	Description															
J4		Connects the shield electrode to either GND or PSoC pin															
J6		To drive the buzzer feature of the board. It will beep once on every button press.															
J7		To configure the Output Select feature between Keypad Scan Interface, Truth Table Interface and Encoded GPO output															
J9		Enable/Disable Deep Sleep Feature on board															
J10	 <table border="1"> <thead> <tr> <th></th> <th>MTS</th> <th>MFS</th> </tr> </thead> <tbody> <tr> <td>1:2</td> <td>Yes</td> <td>No</td> </tr> <tr> <td>3:4</td> <td>Yes</td> <td>Yes</td> </tr> <tr> <td>5:6</td> <td>No</td> <td>Yes</td> </tr> <tr> <td>7:8</td> <td>No</td> <td>No</td> </tr> </tbody> </table>		MTS	MFS	1:2	Yes	No	3:4	Yes	Yes	5:6	No	Yes	7:8	No	No	Enable/Disable MTS and MFS feature
	MTS	MFS															
1:2	Yes	No															
3:4	Yes	Yes															
5:6	No	Yes															
7:8	No	No															
J13		VCC_SYS enable jumper															

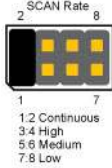
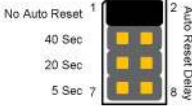
<p><b>J15</b></p>		<p><b>Configure the Scan Rate HW Strap feature</b></p>
<p><b>J16</b></p>		<p><b>Configure the ARST HW Strap feature</b></p>

## Chapter 3

# *Using the CapSense Matrix Button*

## *Keypad*

This section describes the detailed information of the components and connectors of the CapSense Matrix Button Keypad board.

### 3.1 User Input/Output

The user input/output provide a versatile and reliable drop-in replacement for mechanical matrix solutions using an output truth table described later. For demonstration purposes, these pins are connected to LEDs.

- **LEDs**

The CapSense Matrix Solution board consists of 16 red LEDs above the 4 x 4 Matrix CapSense touch buttons for user feedback. The 16 red LEDs are organized in a 4 x 4 matrix. Multiplexing is used to reduce the number of pins needed to drive an LED. The 16 red LED is split into 4 rows and 4 columns which allow you drive it using 4 row outputs and 4 column outputs. **Figure 3-1** shows its arrangement.

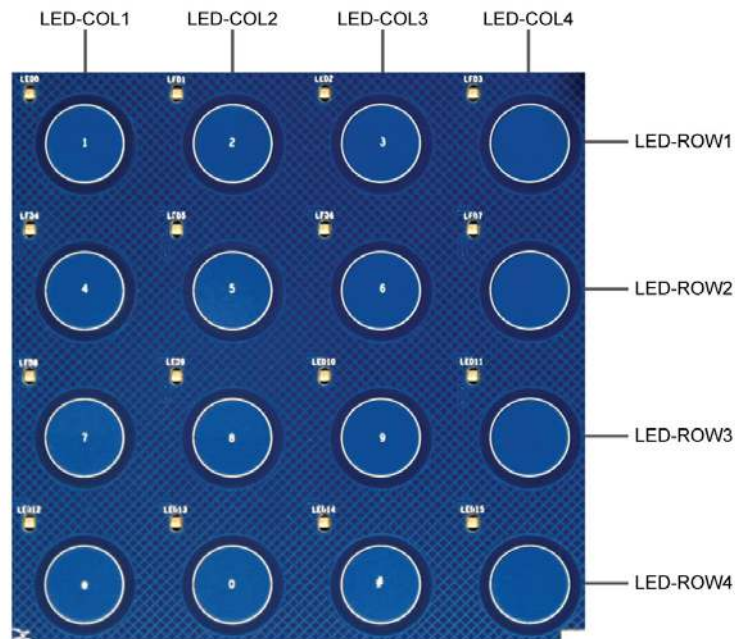

**Figure 3-1 LED Arrangement**

- **Mechanical Matrix Truth Table Output**

The table below lists the truth table for the 4x4 (16) button solutions. The dots indicate the connected terminals corresponding to the row and column LEDs illustrated above. The associated button location (1-16) is shown in **Figure 3-2**. The following GPO pins (GPO\_0-GPO\_7) share pin connection with LED column and row pins (LED-COL1-LED--COL4, LED-ROW1-LED--ROW4).

**Table 3-1 Names and Description of the 5 pin Header**

4X4		Matrix Codes							
Button Location	1	•				•			
	2		•			•			
	3			•		•			
	4				•	•			
	5	•					•		
	6		•				•		
	7			•			•		
	8				•		•		
	9	•							•
	10		•						•
	11			•					•
	12				•				•
	13	•							•
	14		•						•
	15			•					•
	16				•				•
		1	2	3	4	1	2	3	4
		Column				Row			

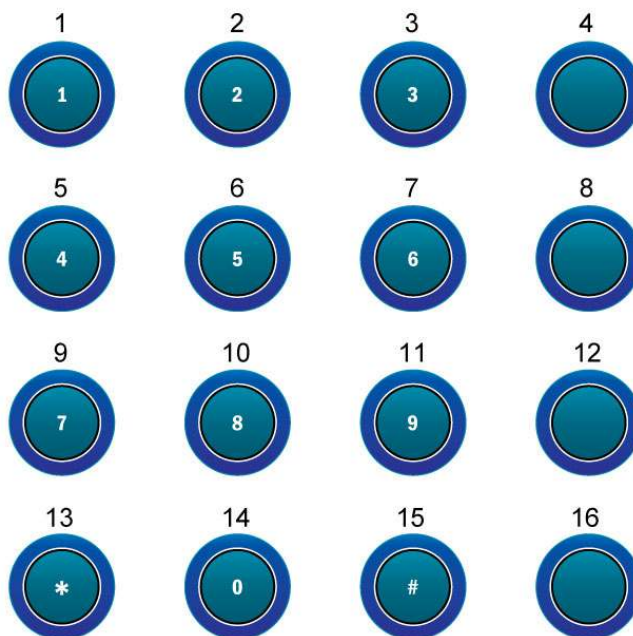

**Figure 3-2 Button Location**

- **Push-button**

The CapSense Matrix Button Keypad board includes a reset push-button (SW1) to allow a system reset signal for designs loaded into the PSoC device. The push-button provides a high logic level or a low logic level when it is not pressed or pressed, respectively.

- **Audio Beep Buzzer**

The CapSense Matrix Button Keypad board contains an audio beep buzzer for an audible beep feedback for any button press.

- **4x4 Matrix-type Capacitive Touch Buttons**

4x4 (16) CapSense buttons are connected and laid out in a matrix-type fashion on the CapSense Matrix Keyboard board. The 16 CapSense buttons include 12 standard buttons marked with 0-9, \* and # symbols. The remainder 4 buttons are unlabeled. **Figure 3-3** illustrates the CapSense buttons matrix-type layout.

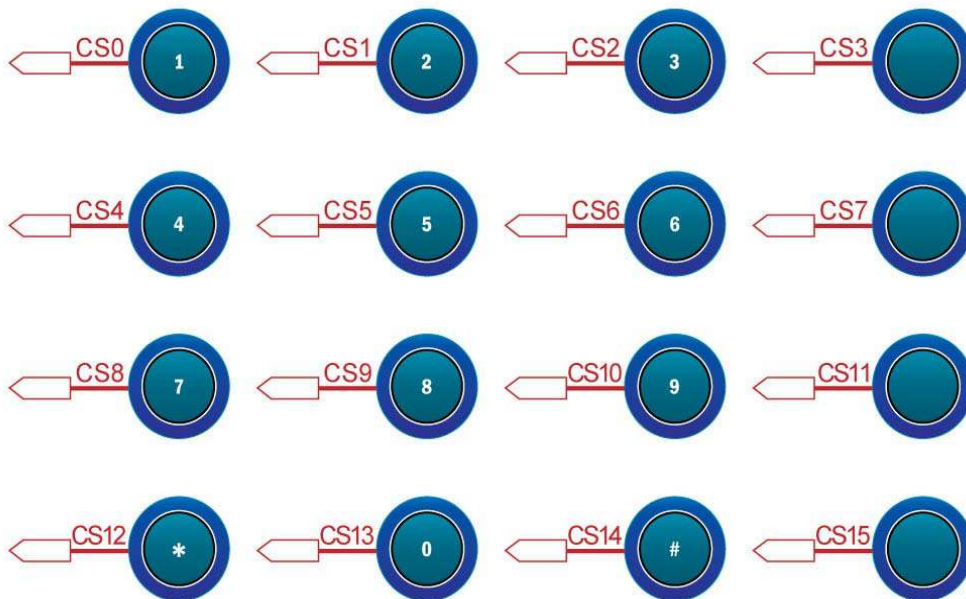

**Figure 3-3 CapSense Buttons Layout**

### 3.2 GPO Header

The board provides 8 GPO interface pins for host communication plus one GPO for generating an interrupt for host controller. The GPO header share pin connection with LED interface, as a result only one can be used. **Figure 3-4** shows the block diagram for the Encoded Keyscan GPO interface.

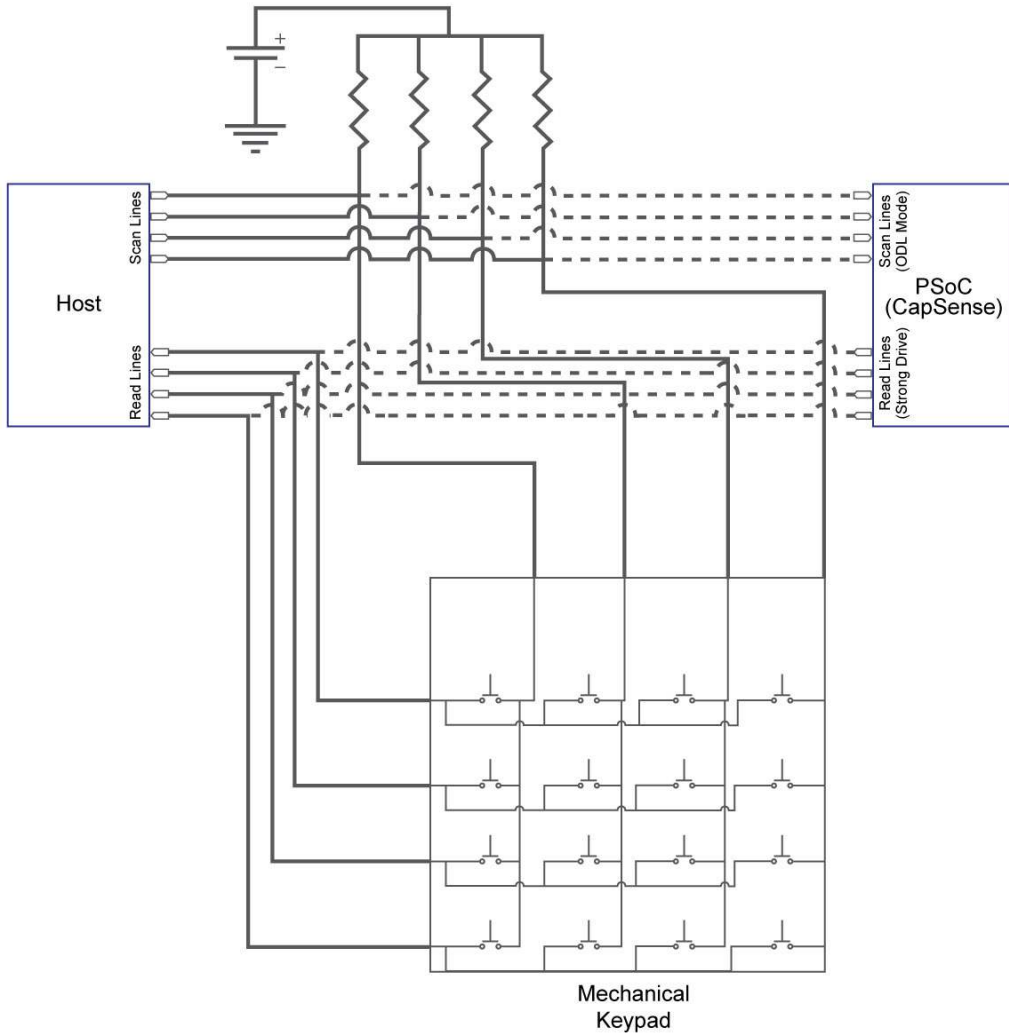

**Figure 3-4 Encoded Keyscan GPO Interface Block Diagram**



### 3.3 Power Supply

The Cypress CapSense Matrix Button Keypad board’s power is provided through 5V power of the USB Type mini-AB connector or the ISSP Programming header. The DC voltage is then stepped down to a regulator providing 3.3V.

- **Power Distribution System**

**Figure 3-5** shows the power distribution system on the Cypress CapSense Matrix Button Keypad board.

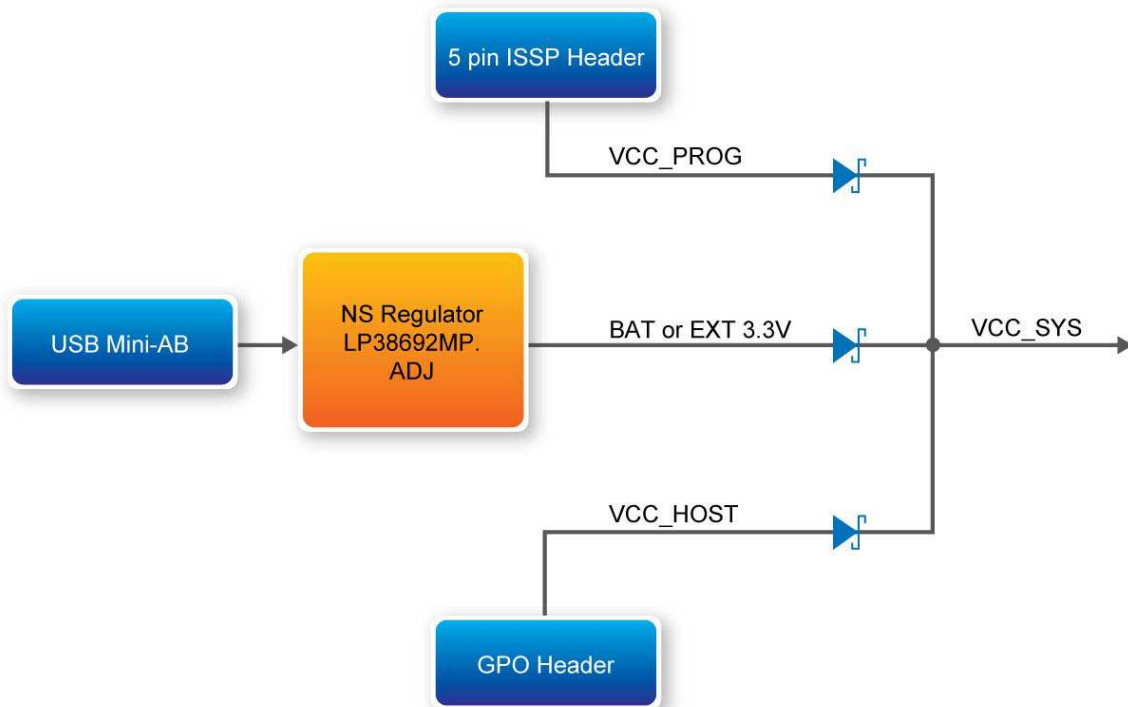

**Figure 3-5 Power Distribution System**

## Chapter 4

# *Project Examples*

This chapter introduces examples of the CapSense Matrix Button Keypad board by using the capacitive touch buttons with Cypress's CapSense/SmartSense technology.

### 4.1 System Requirements

Make sure PSoC Programmer is installed on your PC and PSoC MiniProg (sold separately) is used.

- PSoC Programmer Setup

Multiple versions of PSoC Programmer cannot be installed on the same computer. Un-install any previous version.

Installing from PSoC Programmer CD-ROM:

1. Place the System CD-ROM in your CD-ROM drive
2. At the setup screen, select Install PSoC Programmer.
3. Proceed as directed.

### 4.2 LEDs

The first example project demonstrates the ability of the PSoC device to integrate CapSense, LED driving capabilities. The CapSense buttons are configured so that when a button is touched its corresponding LED lights up. In addition, a buzzer sound will activate whenever a button is pressed.



## 4.3 Firmware Functionality

Below describes some of the features implemented in the LED example.

- **MTS/MFS**

Using the MTS/MFS jumper, you can enable/disable the MTS/MFS feature.

- **ARST**

The Sensor Auto Reset time can be controlled on the ARST jumper. When Auto Reset feature is enabled, if a key is pressed/active for more than 5, 20 or 40 seconds the device resets the key.

- **Scan Rate**

The firmware reads resistor values and reset sets the scan rate of the CapSense device.

Scan Rate configuration:

1. Pin grounded – low
2. 1.5K(5%) ohms resistor to ground – medium
3. 5K (5%) resistor to ground – high
4. Pin connected to  $V_{DD}$  or left floating – continuous

- **Deep Sleep Control**

The Deep Sleep jumper setting sets the device to active or deep sleep modes.

Deep Sleep configuration:

1. Pin grounded – Sleep state disabled
2. VCC\_SYS – Sleep state enabled



## Demonstration Setup

- Power on the board using an USB A to Mini-B cable (included)
- Check the functionality and demonstration features by adjusting the jumper settings.

## Chapter 5

# Appendix

### 5.1 Revision History

<i>Version</i>	<i>Change Log</i>
V1.0	Initial Version (Preliminary)

### 5.2 Copyright Statement

Copyright © 2010 Terasic Technologies. All rights reserved.

### Getting Help

Here are the addresses where you can get help if you encounter problems:

- Terasic Technologies / Cypress Semiconductor
- Tel: +1(800)541-4736 Ext.8(in the USA) / +1(408)943-2600 Ext.8(International)
- Support Link: [www.cypress.com/go/support](http://www.cypress.com/go/support)

Terasic Technologies provides design consulting services to customers in electronic system development to help accelerate their system from design to production. Please contact us below for more info:

- Terasic Technologies
- Tel: +886-3-550-8800 (China and Taiwan)
- Email: [cysupport@terasic.com](mailto:cysupport@terasic.com)