

**SINGLE-PHASE GLASS PASSIVATED
SILICON BRIDGE RECTIFIER**

VOLTAGE RANGE 50 to 1000 Volts CURRENT 25 Amperes

FEATURES

- * Superior thermal desing
- * 1/4" universal faston terminal
- * Hole thru for # 10 screw

MECHANICAL DATA

- * UL listed the recognized component directory, file #E94233
- * Epoxy: Device has UL flammability classification 94V-O



MP-25W

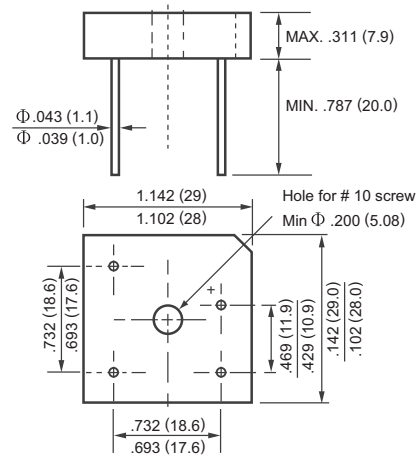

Dimensions in inches and (millimeters)

MAXIMUM RATINGS AND ELECTRICAL CHARACTERISTICS

Ratings at 25 °C ambient temperature unless otherwise specified.
Single phase, half wave, 60 Hz, resistive or inductive load.
For capacitive load, derate current by 20%.

MAXIMUM RATINGS (At TA = 25°C unless otherwise noted)

RATINGS	SYMBOL	MP2505W	MP251W	MP252W	MP254W	MP256W	MP258W	MP2510W	UNITS	
Maximum Recurrent Peak Reverse Voltage	VRRM	50	100	200	400	600	800	1000	Volts	
Maximum RMS Bridge Input Voltage	VRMS	35	70	140	280	420	560	700	Volts	
Maximum DC Blocking Voltage	VDC	50	100	200	400	600	800	1000	Volts	
Maximum Average Forward Rectified Output Current at Tc = 55°C	Io	25.0								Amps
Peak Forward Surge Current 8.3 ms single half sine-wave superimposed on rated load (JEDEC method)	IFSM	300								Amps
Peak Forward Surge Current 10 ms single half sine-wave superimposed on rated load (JEDEC method)	IFSM	273.3								Amps
Typical Current Squared Time	I ² t	373.5								A ² S
RMS isolation voltage from case to lead	VISO	2500								Volts
Typical Thermal Resistance (from junction to case)	RθJC	1.9								°C/W
Typical Thermal Resistance (from junction to ambient)	RθJA	19								
Operating and Storage Temperature Range	TJ, TSTG	-55 to + 150								°C

ELECTRICAL CHARACTERISTICS (At TA = 25°C unless otherwise noted)

CHARACTERISTICS	SYMBOL	MP2505W	MP251W	MP252W	MP254W	MP256W	MP258W	MP2510W	UNITS	
Maximum Forward Voltage Drop per element at 12.5A DC	VF	1.1								Volts
Maximum Reverse Current at Rated	IR	5.0								uAmps
DC Blocking Voltage per element		1.0								mAmps

NOTE: 1. Suffix "W" for wire type
2. "ROHS compliant".

RATING AND CHARACTERISTIC CURVES(MP2505W THRU MP2510W)

FIG. 1 - MAXIMUM NON-REPETITIVE FORWARD SURGE CURRENT

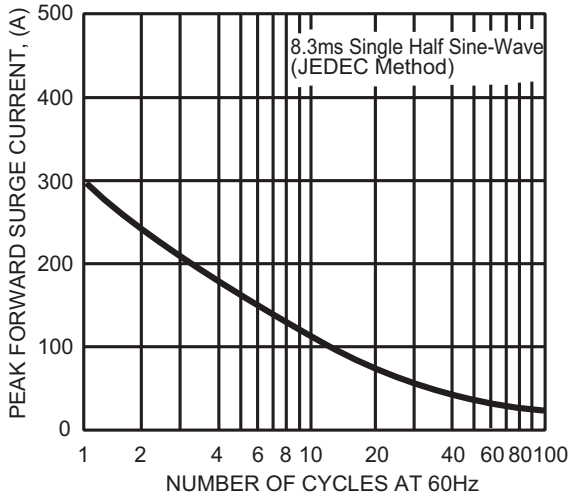

FIG. 2 - TYPICAL FORWARD CURRENT DERATING CURVE

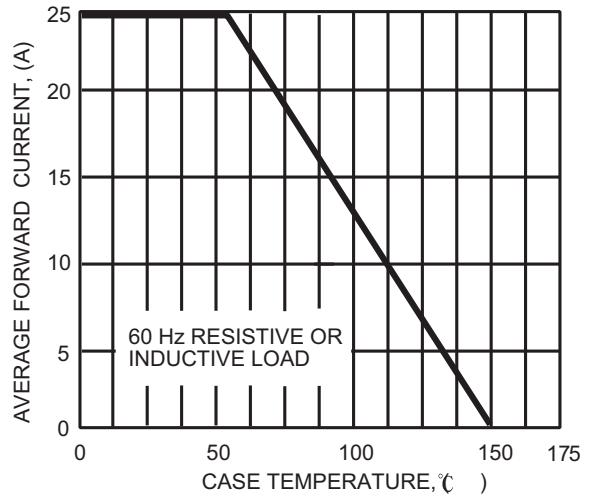

FIG. 3- TYPICAL INSTANTANEOUS FORWARD CHARACTERISTICS

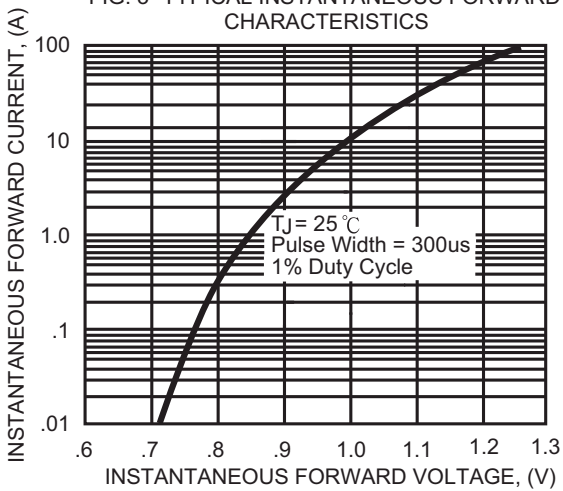
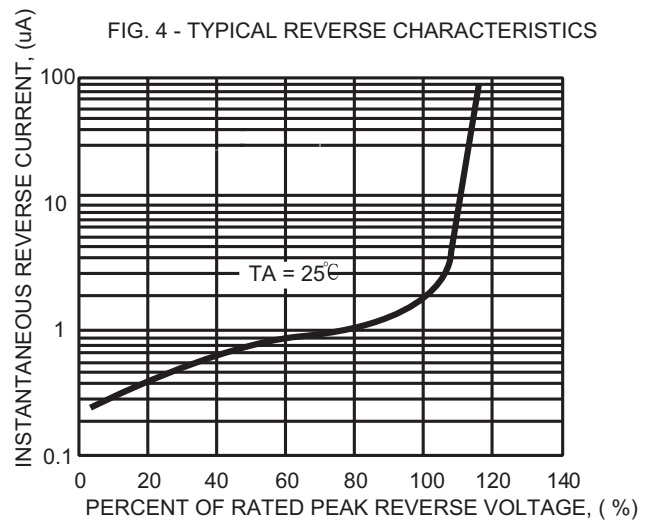

FIG. 4 - TYPICAL REVERSE CHARACTERISTICS





RECTRON

Attachment information about MP25XW

1. Internal Circuit

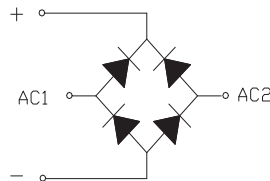

2. Marking on the body

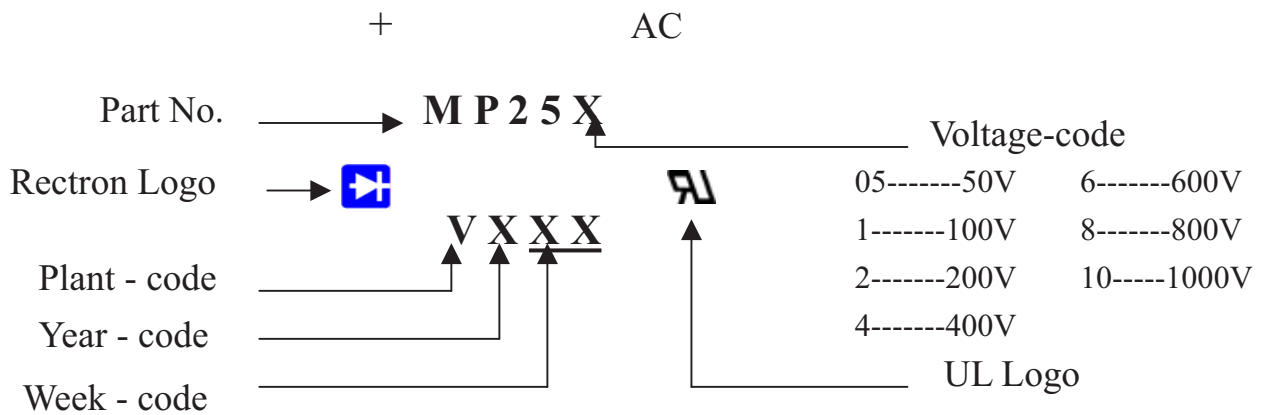

3. Items marked on the inner box and carton

3.1 On the box (for -B)

CUSTOMER
TYPE
LOT NO.
QUANTITY
Q.A.
DATE

3.2 On the carton

CUSTOMER
TYPE
QUANTITY
LOT NO.
REMARK

PACKAGING OF DIODE AND BRIDGE RECTIFIERS

BULK PACK

PACKAGE	PACKING CODE	EA PER BOX	INNER BOX SIZE (mm)	CARTON SIZE (mm)	EA PER CARTON	GROSS WEIGHT(Kg)
MP-15/-25/-35W	-B	50	206*208*57	450*220*255	400	8.26

DISCLAIMER NOTICE

Rectron Inc reserves the right to make changes without notice to any product specification herein, to make corrections, modifications, enhancements or other changes. Rectron Inc or anyone on its behalf assumes no responsibility or liability for any errors or inaccuracies. Data sheet specifications and its information contained are intended to provide a product description only. "Typical" parameters which may be included on RECTRON data sheets and/ or specifications can and do vary in different applications and actual performance may vary over time. Rectron Inc does not assume any liability arising out of the application or use of any product or circuit.

Rectron products are not designed, intended or authorized for use in medical, life-saving implant or other applications intended for life-sustaining or other related applications where a failure or malfunction of component or circuitry may directly or indirectly cause injury or threaten a life without expressed written approval of Rectron Inc. Customers using or selling Rectron components for use in such applications do so at their own risk and shall agree to fully indemnify Rectron Inc and its subsidiaries harmless against all claims, damages and expenditures.