

### General information

|                   |                     |
|-------------------|---------------------|
| Part number       | S20F1C-P07MCCO-150S |
| Termination       | solder              |
| Size              | 0                   |
| Locking principle | push                |
| Coding            | 1_halfshell         |
| Cable Diameter    | cable_mini_15       |
| Cable outlet      | bend_relief         |

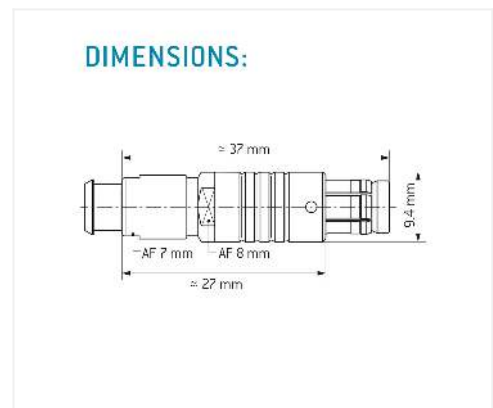
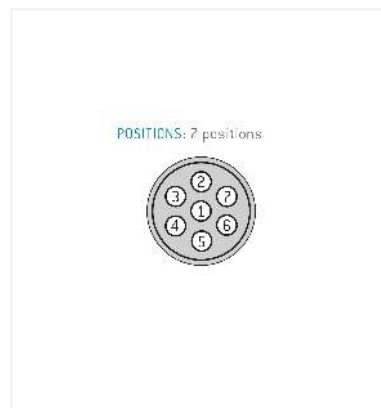

### Contact insert description

|                      |        |
|----------------------|--------|
| Number of contacts   | 7      |
| Contact type         | pins   |
| Contact diameter     | 05mm   |
| Insulator material   | peek   |
| Wire cross section   | 28_awg |
| Termination          | solder |
| Termination diameter | 04mm   |

reverse\_gender\_on\_request

### Technical information

|  |          |               |
|--|----------|---------------|
| Max. creepage and air clearance distance | 07_mm    | 06_mm         |
| Nominal current single contact           | 04_a     | iec_60512_5_2 |
| Nominal current insert                   | 2,6 A    | vde_0298_4    |
| Test voltage                             | 09_kv_ac | sae_13441     |

safety\_text

## Mechanical and environmental data

|                       |      |
|-----------------------|------|
| Degree of protection* | ip50 |
|-----------------------|------|

|                       |          |
|-----------------------|----------|
| Operating temperature | 40_120_c |
|-----------------------|----------|

|               |      |
|---------------|------|
| Mating cycles | 5000 |
|---------------|------|

mated\_unmated

## Material and surface treatments

|         |          |
|---------|----------|
| Housing | m_chrome |
|---------|----------|

|         |               |
|---------|---------------|
| Contact | cu_alloy_gold |
|---------|---------------|

safety\_text\_2

ul\_text

illustrative\_text