

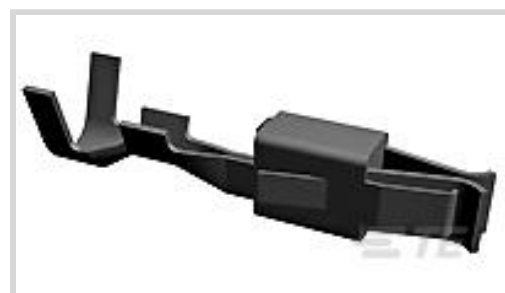

Terminals & Splices > Automotive Terminals > TIMER, RECEPTACLE AND TAB



Terminal Type: **Receptacle**

Mating Tab Width: **2.8 mm [.11 in]**

Mating Tab Thickness: **.8 mm [.031 in]**

Terminal Transmits: **25 – 40 A (Power)**

Wire Size: **16 – 13 AWG**

[All TIMER, RECEPTACLE AND TAB \(348\)](#)

Features

Product Type Features

Sealable	Yes
Primary Locking Feature	Locking Lance

Body Features

Terminal Seal Type	Single Wire Seal (SWS)
--------------------	------------------------

Contact Features

Contact Size	2.8mm
Contact Fabrication	Stamped & Formed
Wire Contact Termination Area Plating Material	Tin
Typical Current Rating	30 A
Crimp Type	F-Crimp
Terminal Type	Receptacle
Mating Tab Width	2.8 mm[.11 in]
Mating Tab Thickness	.8 mm[.031 in]
Interface Plating	Tin (Sn)

Termination Features

Termination Method to Wire & Cable	Crimp
Product Terminates To	Wire



Dimensions

Compatible Insulation Diameter Range	2.7 – 3 mm [.106 – .118 in]
Wire Size	1.5 – 2.5 mm ²
Tab Length	21 mm [.826 in]

Usage Conditions

Insulation Option	Uninsulated
Operating Temperature (Max)	130 °C [266 °F]
Operating Temperature Range	-40 – 130 °C [-40 – 266 °F]

Operation/Application

Compatible With Wire Base Material	Copper
------------------------------------	--------

Industry Standards

Agency/Standard	DIN 72 551 Part 6, DIN ISO 6722 part 3
-----------------	--

Packaging Features

Packaging Quantity	3700
Packaging Method	Reel

Other

Terminal Transmits	25 – 40 A (Power)
--------------------	-------------------

Product Compliance

[For compliance documentation, visit the product page on TE.com>](#)

EU RoHS Directive 2011/65/EU	Compliant
EU ELV Directive 2000/53/EC	Compliant
China RoHS 2 Directive MIIT Order No 32, 2016	No Restricted Materials Above Threshold
EU REACH Regulation (EC) No. 1907/2006	Current ECHA Candidate List: JUNE 2023 (235) Candidate List Declared Against: JUNE 2023 (235) Does not contain REACH SVHC
Halogen Content	Low Halogen - Br, Cl, F, I < 900 ppm per homogenous material. Also BFR/CFR/PVC Free
Solder Process Capability	Not applicable for solder process capability

Product Compliance Disclaimer

This information is provided based on reasonable inquiry of our suppliers and represents our current actual knowledge based on the information they provided. This information is subject to change. The part numbers that TE has identified as EU RoHS compliant have a maximum concentration of 0.1% by weight in homogenous materials for lead, hexavalent chromium, mercury, PBB, PBDE, DBP, BBP, DEHP, DIBP, and 0.01% for cadmium, or qualify for an exemption to these limits as defined in the Annexes of Directive 2011/65/EU (RoHS2). Finished electrical and electronic equipment products will be CE marked as required by Directive 2011/65/EU. Components may not be CE marked. Additionally, the part numbers that TE has identified as EU ELV compliant have a maximum concentration of 0.1% by weight in homogenous materials for lead, hexavalent chromium, and mercury, and 0.01% for cadmium, or qualify for an exemption to these limits as defined in the Annexes of Directive 2000/53/EC (ELV). Regarding the REACH Regulation, the information TE provides on SVHC in articles for this part number is based on the latest European Chemicals Agency (ECHA) 'Guidance on requirements for substances in articles' posted at this URL: <https://echa.europa.eu/guidance-documents/guidance-on-reach>

Compatible Parts



TE Part # CAT-T4827-CH8172
Timer Connector Housing



TE Part # 4-1579007-3
EXTRACTION TOOL KIT



TE Part # 1-1579007-6
EXTRACTION TOOL

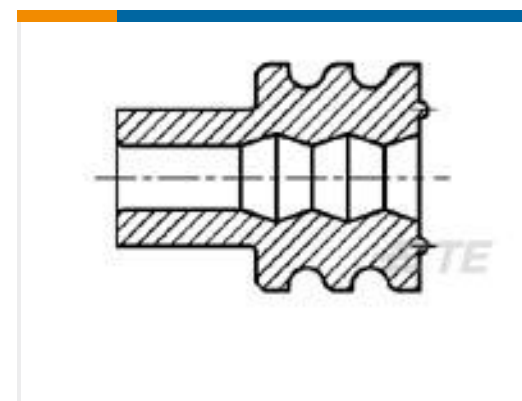

TE Part # 963292-1
WIRE SEALING 2,2



TE Part # 828905-1
SINGLE-WIRE-SEAL(5MM HOLE)



TE Part # 2305570-1
Strip Terminal Cutter-Side Feed-No Crimp



TE Part # 2137216-1
3P SPLASH PROOF CONNECTOR ASS'



TE Part # 828904-1
SINGLE WIRE SEAL FOR J.P.T.CON



TE Part # 2-2151109-1
OCEAN_2.0_APPLICATOR-S-110F1700



TE Part # 2-2151109-2
OCEAN_2.0_APPLICATOR-S-110F1700



TE Part # 2137216-2
3P SPLASH PROOF CONNECTOR ASS'



TE Part # 2151109-1
OCEAN_2.0_APPLICATOR-S-110F1700



TE Part # 2151109-2
OCEAN_2.0_APPLICATOR-S-110F1700



TE Part # 282648-1
SPLASH PROOF CONN. W.S.L.2 WAY



TE Part # 5-2151109-1
OCEAN_2.0_APPLICATOR-S-110F1700



TE Part # 5-2151109-2
OCEAN_2.0_APPLICATOR-S-110F1700



TE Part # 7-2151109-1
OCEAN_2.0_APPLICATOR-S-110F170O



TE Part # 7-2151109-2
OCEAN_2.0_APPLICATOR-S-110F170O



TE Part # 7-2151109-7
OCEAN_2.0_SPARE_PART_KIT-110F170D



TE Part # 7-2266069-7
OC-110F170O-752-CRIMPTOOLINGKIT

Also in the Series | Junior Power Timer



Automotive Connector Caps & Covers (5)



Automotive Housings(251)



Automotive Seals & Cavity Plugs(10)



Automotive Terminals(86)



Busbars & Terminals(1)



Insertion & Extraction Tools(8)



Module Components(6)



Other Automotive Connector Accessories(1)



PCB Headers & Receptacles(1)

Customers Also Bought



TE Part #828905-1
SINGLE-WIRE-SEAL(5MM HOLE)



TE Part #2005275-3
MT3/JPT/SPT HYB 58P CAP ASSY



TE Part #964324-1
SPT A REC 6.3 Contact SRC Sn



TE Part #927838-2
SPT REC 6.3 Contact SRC Sn (LP)

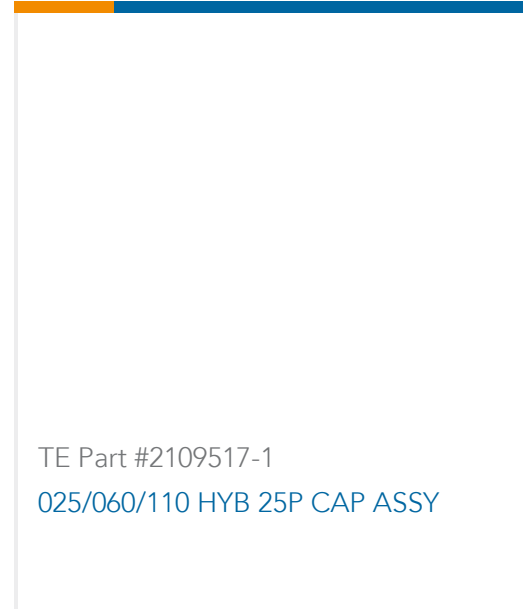
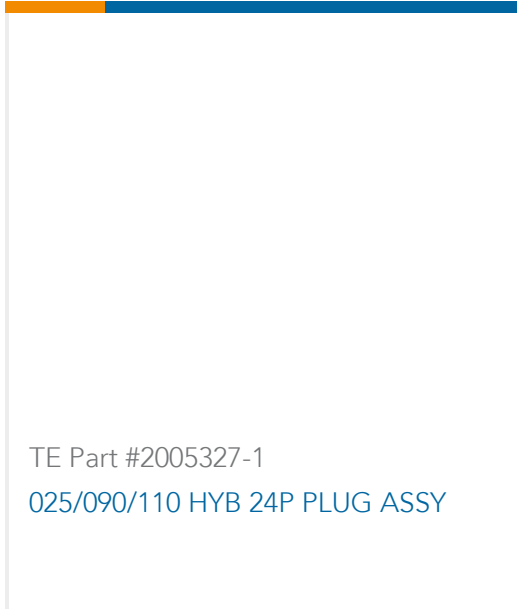
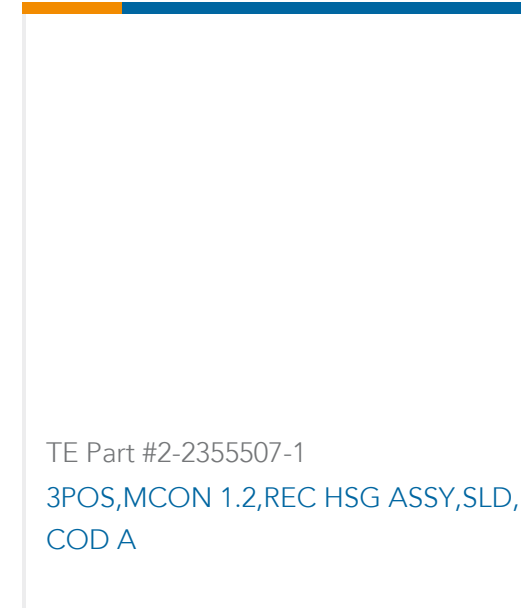
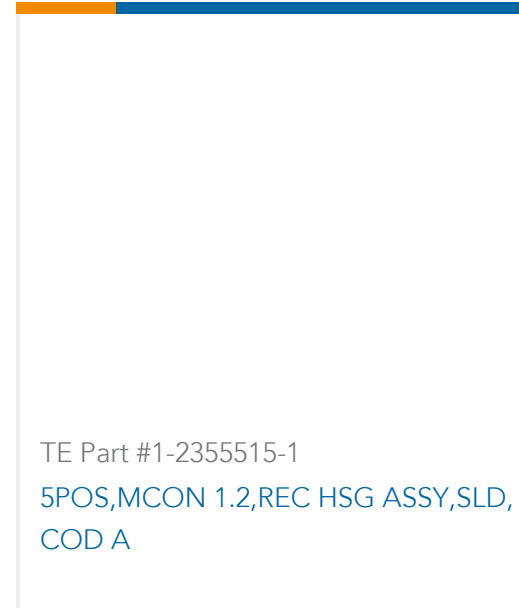
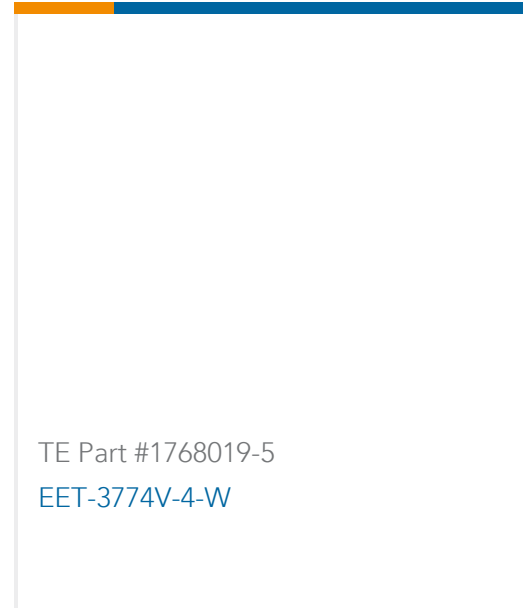

Documents

Product Drawings

[JPT REC 2.8 Contact SWS Sn](#)

English

[JPT REC 2.8 Contact SWS Sn](#)

English

CAD Files

Customer View Model

[ENG_CVM_929937-3_A9.3d_igs.zip](#)

English

Customer View Model

[ENG_CVM_929937-3_A9.3d_stp.zip](#)

English

3D PDF

English

Customer View Model

[ENG_CVM_929937-3_A9.2d_dxf.zip](#)

English

By downloading the CAD file I accept and agree to the [Terms and Conditions](#) of use.

Datasheets & Catalog Pages

[Timer Interconnection System](#)

English

Product Specifications

[Application Specification](#)

German



Application Specification

English

Application Specification

English

Instruction Sheets

[Instruction Sheet \(non U.S.\)](#)

French