

XMLA500N2S11

pressure switch XMLA 500 bar - fixed scale 1
threshold - 1 C/O



Main

Range of Product	Telemecanique Pressure sensors XM
Product or Component Type	Electromechanical pressure sensor
Pressure sensor type	Electromechanical pressure sensor
Device short name	XMLA
Pressure Rating	7251.89 psi (500 bar)
Controlled fluid	Air 32...320 °F (0...160 °C) Corrosive fluid 32...320 °F (0...160 °C))
Fluid connection type	G 1/4 (female) ISO 228
Electrical connection	Screw-clamps terminals, 1 x 0.5...2 x 2.5 mm ² 1 connector Pg 13
AWG Gauge	AWG 20...AWG 14
Cable entry	Cable gland 0.35...0.51 in (9...13 mm)
Contacts type and composition	1 C/O
Product Specific Application	-
Pressure switch type of operation	Detection of 1 single threshold
Electrical circuit type	Control circuit
Scale type	Fixed differential
Local display	With
Adjustable range of switching point on rising pressure	435.11...7251.89 psi (30...500 bar)
Adjustable range of switching point on falling pressure	145.04...6599.22 psi (10...455 bar)
Maximum permissible accidental pressure	16316.75 psi (1125 bar)
Destruction pressure	32633.49 psi (2250 bar)
Pressure actuator	Piston
Materials in contact with fluid	FPM, FKM PTFE 316L stainless steel
Enclosure Material	Zinc alloy
Line Rated Current	3 A, B300, AC-15 (Ue = 120 V)EN/IEC 60947-5-1 1.5 A, B300, AC-15 (Ue = 240 V)EN/IEC 60947-5-1 0.1 A, R300, DC-13 (Ue = 250 V)EN/IEC 60947-5-1

Complementary

Natural differential at low setting	290.08 psi (20 bar) +/- 6 bar)
Natural differential at high setting	652.67 psi (45 bar) +/- 10 bar)
Maximum permissible pressure - per cycle	9064.86 psi (625 bar)
Terminal block type	4 terminals
Maximum operating rate	60 cyc/mn
Repeat accuracy	2 %
[Ui] rated insulation voltage	300 V UL 508 500 V EN/IEC 60947-1 300 V CSA C22.2 No 14
[Uimp] rated impulse withstand voltage	6 kV EN/IEC 60947-1
Auxiliary contacts operation	Snap action

Contacts material	Silver contacts
Maximum resistance across terminals	25 MOhm IEC 255-7 category 3 25 mOhm NF C 93-050 method A
Short-circuit protection	10 A cartridge fuse gG (gl)
Mechanical durability	3000000 cycles
Setting	External
Height	4.45 in (113 mm)
Depth	2.95 in (75 mm)
Width	1.38 in (35 mm)
Net Weight	1.65 lb(US) (0.75 kg)

Environment

Standards	EN/IEC 60947-5-1 UL 508 CSA C22.2 No 14 CE
Product Certifications	UL CSA LROS (Lloyds register of shipping) CCC EAC BV
Protective treatment	TC standard version
Ambient Air Temperature for Operation	-13...158 °F (-25...70 °C)
Ambient Air Temperature for Storage	-40...158 °F (-40...70 °C)
Operating position	Any position
Vibration resistance	4 gn 30...500 Hz)IEC 60068-2-6
Shock resistance	50 gn IEC 60068-2-27
Electrical shock protection class	Class I IEC 1140 Class I IEC 536 Class I NF C 20-030
IP degree of protection	IP66 conforming to EN/IEC 60529

Ordering and shipping details



Category	22661-XMLA,B,C,D PRESSURE SWITCHES
Discount Schedule	DS2
GTIN	3389110712476
Nbr. of units in pkg.	1
Package weight(Lbs)	3.00 oz (85.0 g)
Returnability	No
Country of origin	FR

Packing Units

Unit Type of Package 1	PCE
Package 1 Height	4.92 in (12.5 cm)
Package 1 width	1.65 in (4.2 cm)
Package 1 Length	3.23 in (8.2 cm)

Offer Sustainability

Sustainable offer status	Green Premium product
California proposition 65	WARNING: This product can expose you to chemicals including: Diisononyl phthalate (DINP), which is known to the State of California to cause cancer, and Di-isodecyl phthalate (DIDP), which is known to the State of California to cause birth defects or other reproductive harm. For more information go to www.P65Warnings.ca.gov
REACH Regulation	 REACH Declaration
EU RoHS Directive	Pro-active compliance (Product out of EU RoHS legal scope)  EU RoHS Declaration
Mercury free	Yes

RoHS exemption information	 Yes
Environmental Disclosure	 Product Environmental Profile

Contractual warranty

Warranty	18 months
----------	-----------

Dimensions

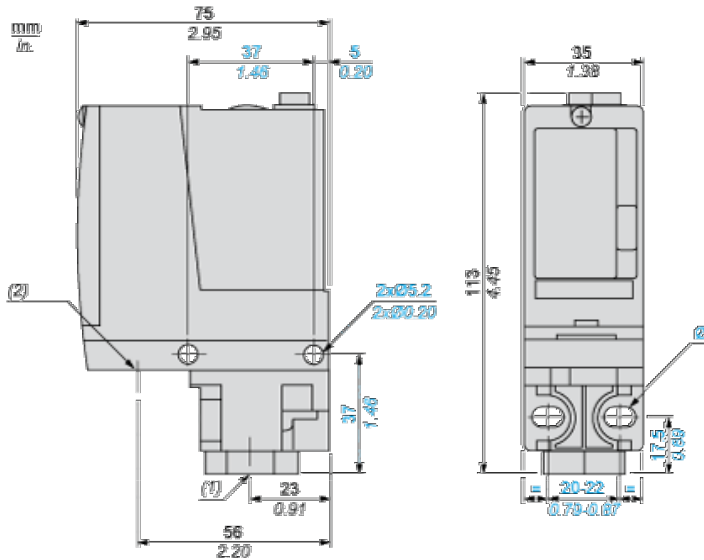

- (1) 1 fluid entry, tapped G1/4 (BSP female)
- (2) 1 electrical connections entry, tapped Pg 13.5
- Ø : 2 elongated holes Ø 5.2 x 6.7

Wiring Diagram

Terminal Model

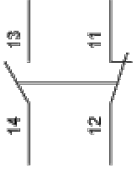

Operating Curves

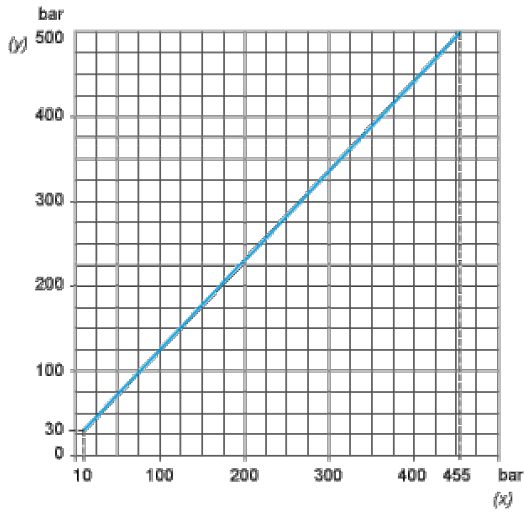

- (y) Rising pressure
- (x) Falling pressure

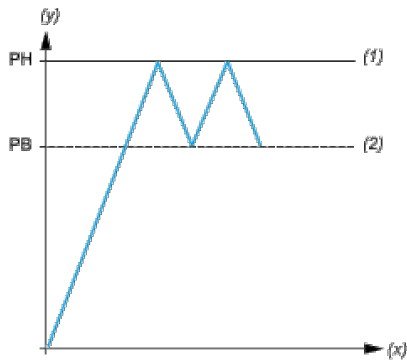

- (y) Pressure
- (x) Time
- (1) Adjustable value
- (2) Non adjustable value
- PH : High point
- PB : Below point