

# "High Frequency Ceramic Solutions"

**2.38GHz / 2.45GHz / 2.6GHz Wideband SMD Chip Antenna** P/N 2500AT44M0400

Designed for: BAN, Bluetooth, 802.11, WLAN, Zigbee, Proprietary Protocol, ISM, Smart Energy, WiMax

Detail Specification: 5/24/2013

Page 1 of 9

## General Specifications

Part Number	2500AT44M0400		<b>Quantity per Reel</b> 1,000	
Operating Frequency (MHz)	2300 - 2700			
Impedance	50 Ω			
Operating Temperature	-40 to +85°C			
Return Loss (2.3-2.7GHz)	9.5 dB min.			
Peak Gain @ 2.38GHz	2.0 dBi typ. (XZ-V)			
Average Gain @ 2.38GHz	0.0 dBi typ. (XZ-V)			
Peak Gain @ 2.45GHz	2.5 dBi typ. (XZ-V)			
Average Gain @ 2.45GHz	0.5 dBi typ. (XZ-V)			
Peak Gain @ 2.60GHz	2.0 dBi typ. (XZ-V)			<b>Recommended Storage Conditions</b> +5 ~ +35 °C, Humidity 45~75%RH
Average Gain @ 2.60GHz	0.0 dBi typ. (XZ-V)			

## Mechanical Specifications

	In	mm
L	0.315 ± 0.008	8.00 ± 0.20
W	0.039 ± 0.008	1.00 ± 0.20
T	0.039 ± 0.008	1.00 ± 0.20
a	0.020 ± 0.008	0.50 ± 0.20
a2	0.039 ± 0.008	1.00 ± 0.20

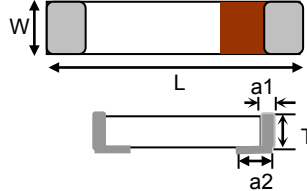

## Terminal Configuration

No.	Function
1	Feeding Point
2	NC

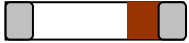

## Mounting Considerations - Layout #1

Mount these devices with brown mark facing up. Units: mm

\*Line width should be designed to provide 50 Ω impedance matching characteristics.

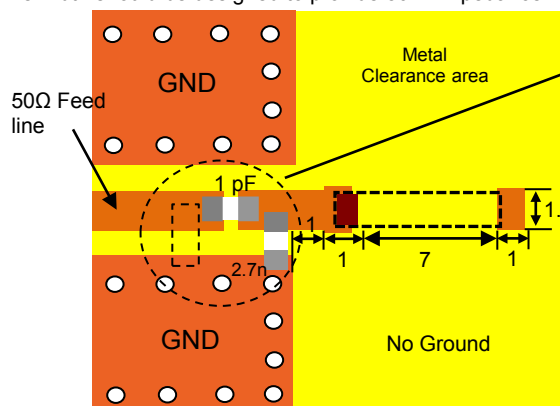

It is recommended that the designer leave available slots for a "pi" (or shunt-series-shunt) network. The antenna matching network values are used when antenna is mounted on Johanson's evaluation board. The matching values on clinet's PCB will be different. Go to: <http://johansontechnology.com/tuning> and see how to obtain the new values. If you need further help, contact our RF Applications Eng Team at: [www.johansontechnology.com/en/ask-a-technical-question.html](http://www.johansontechnology.com/en/ask-a-technical-question.html)

Johanson Technology, Inc. reserves the right to make design changes without notice.

All sales are subject to Johanson Technology, Inc. terms and conditions.



[www.johansontechnology.com](http://www.johansontechnology.com)

4001 Calle Tecate • Camarillo, CA 93012 • TEL 805.389.1166 FAX 805.389.1821

Ver 1.2

2013 Johanson Technology, Inc. All Rights Reserved

# "High Frequency Ceramic Solutions"

2.38GHz / 2.45GHz / 2.6GHz Wideband SMD Chip Antenna P/N 2500AT44M0400

Designed for: BAN, Bluetooth, 802.11, WLAN, Zigbee, Proprietary Protocol, ISM, Smart Energy, WiMax

Detail Specification: 5/24/2013

Page 2 of 9

## Layout #1 example (units in mm)

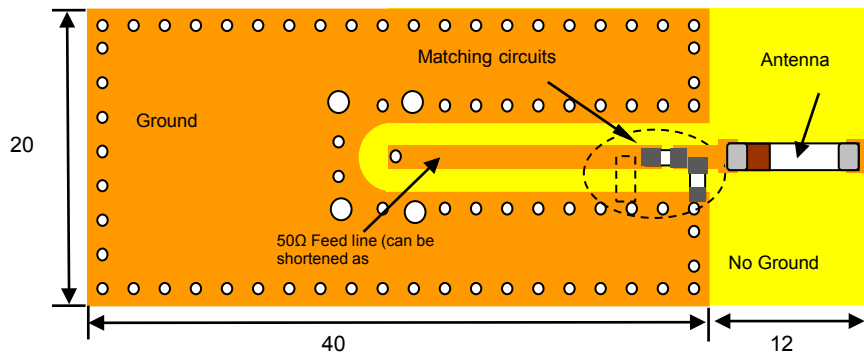

Orderable EVB p/n: 2500AT44M0400-EB1SMA

## Return Loss - with Matching Circuits

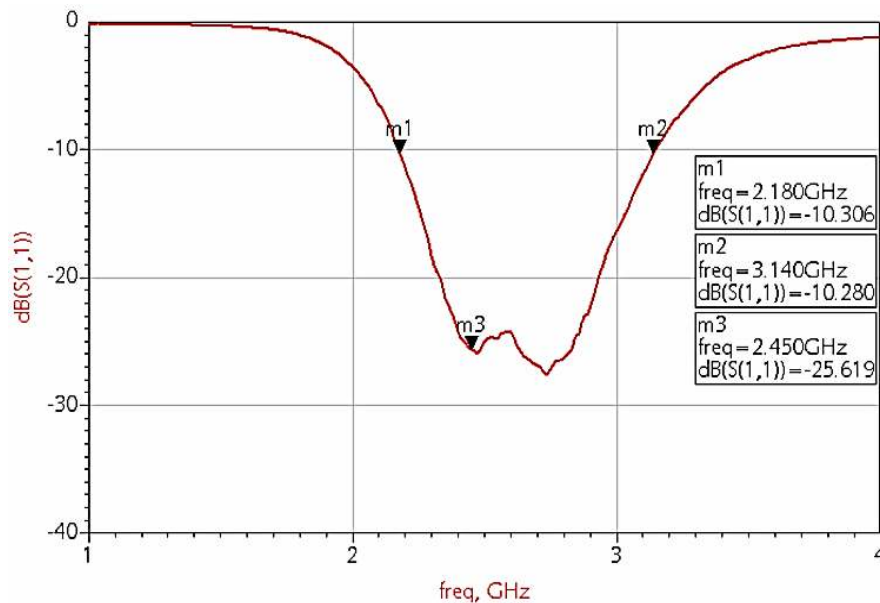

Johanson Technology, Inc. reserves the right to make design changes without notice.

All sales are subject to Johanson Technology, Inc. terms and conditions.



[www.johansontechnology.com](http://www.johansontechnology.com)

4001 Calle Tecate • Camarillo, CA 93012 • TEL 805.389.1166 FAX 805.389.1821

Ver 1.2

2013 Johanson Technology, Inc. All Rights Reserved

# "High Frequency Ceramic Solutions"

2.38GHz / 2.45GHz / 2.6GHz Wideband SMD Chip Antenna

P/N 2500AT44M0400

Designed for: BAN, Bluetooth, 802.11, WLAN, Zigbee, Proprietary Protocol, ISM, Smart Energy, WiMax

Detail Specification: 5/24/2013

Page 3 of 9

## Typical Radiation Patterns @ 2.38GHz - Layout #1

### Typical Radiation Patterns - Layout #1

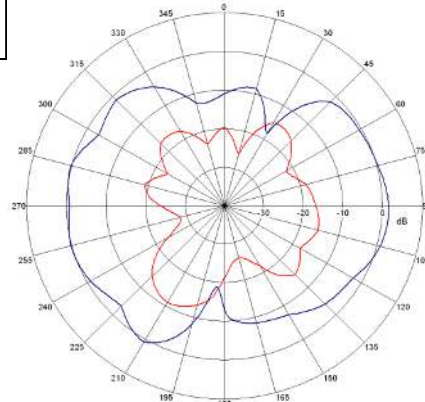
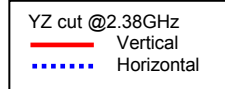
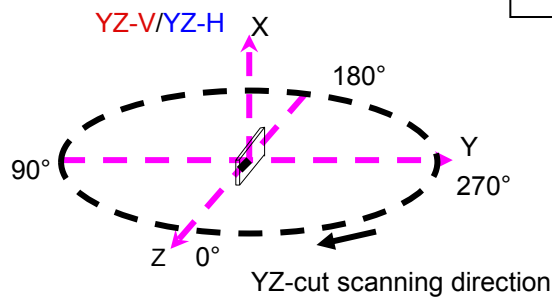
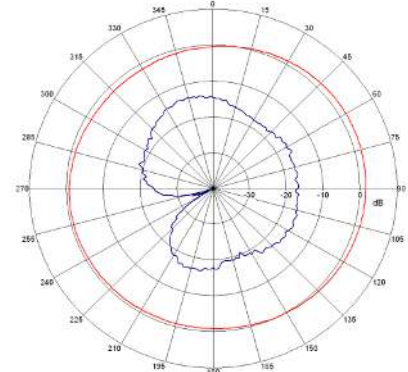
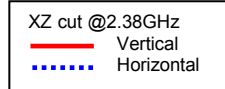
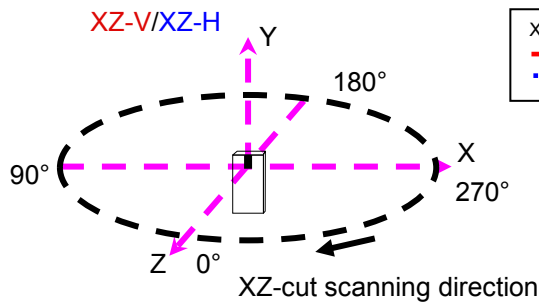
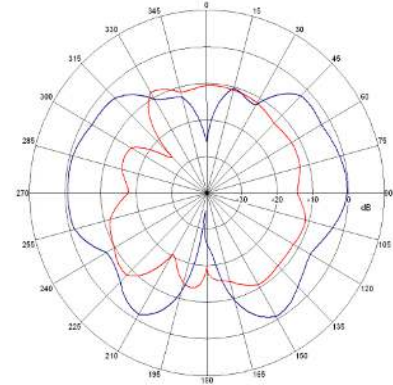
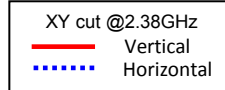
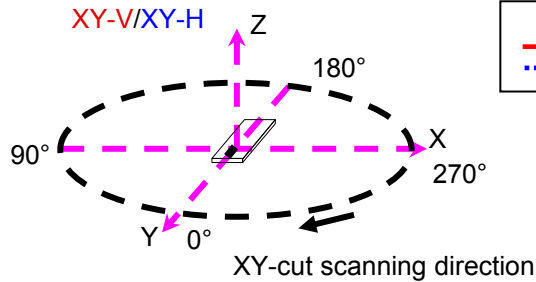

Johanson Technology, Inc. reserves the right to make design changes without notice.

All sales are subject to Johanson Technology, Inc. terms and conditions.



[www.johansontechnology.com](http://www.johansontechnology.com)

4001 Calle Tecate • Camarillo, CA 93012 • TEL 805.389.1166 FAX 805.389.1821

Ver 1.2

2013 Johanson Technology, Inc. All Rights Reserved

# "High Frequency Ceramic Solutions"

2.38GHz / 2.45GHz / 2.6GHz Wideband SMD Chip Antenna

P/N 2500AT44M0400

Designed for: BAN, Bluetooth, 802.11, WLAN, Zigbee, Proprietary Protocol, ISM, Smart Energy, WiMax

Detail Specification: 5/24/2013

Page 4 of 9

## Typical Radiation Patterns @ 2.45GHz - Layout #1

### Typical Radiation Patterns - Layout #1

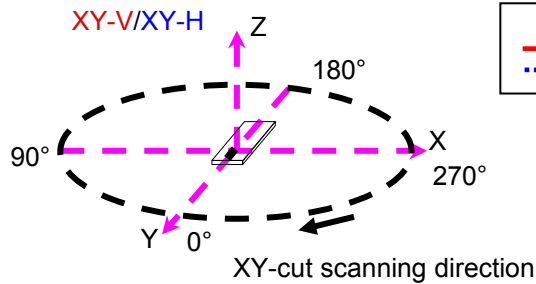

XY cut @2.45GHz  
 — Vertical  
 ..... Horizontal

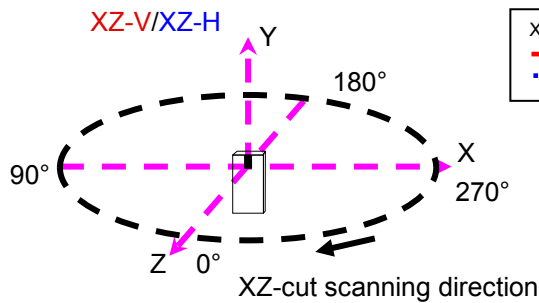
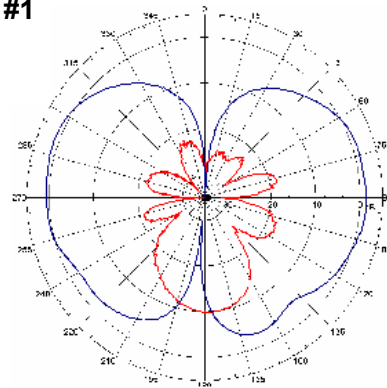

XZ cut @2.45GHz  
 — Vertical  
 ..... Horizontal

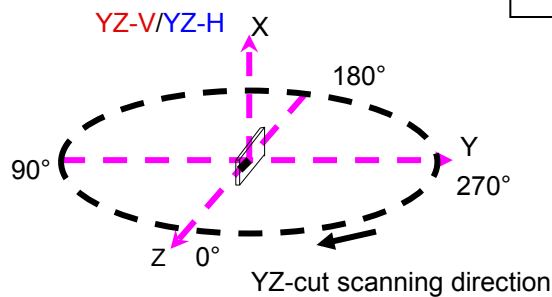
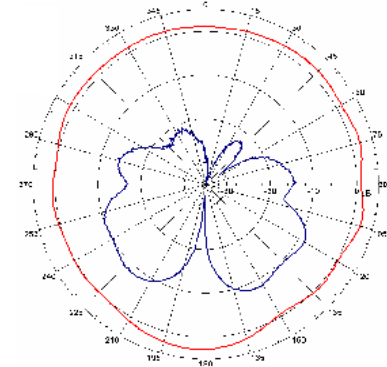

YZ cut @2.45GHz  
 — Vertical  
 ..... Horizontal

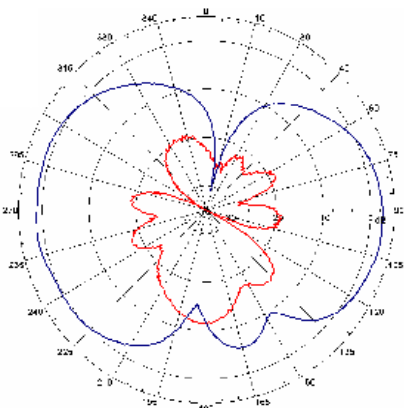

Johanson Technology, Inc. reserves the right to make design changes without notice.  
 All sales are subject to Johanson Technology, Inc. terms and conditions.



[www.johansontechnology.com](http://www.johansontechnology.com)  
 4001 Calle Tecate • Camarillo, CA 93012 • TEL 805.389.1166 FAX 805.389.1821

Ver 1.2

2013 Johanson Technology, Inc. All Rights Reserved

# "High Frequency Ceramic Solutions"

2.38GHz / 2.45GHz / 2.6GHz Wideband SMD Chip Antenna

P/N 2500AT44M0400

Designed for: BAN, Bluetooth, 802.11, WLAN, Zigbee, Proprietary Protocol, ISM, Smart Energy, WiMax

Detail Specification: 5/24/2013

Page 5 of 9

## Typical Radiation Patterns @ 2.6GHz - Layout #1

### Typical Radiation Patterns - Layout #1

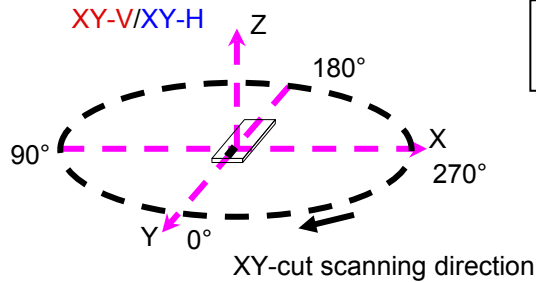

XY cut @2.6GHz  
 — Vertical  
 ..... Horizontal

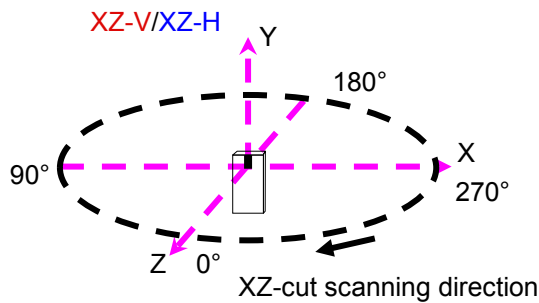
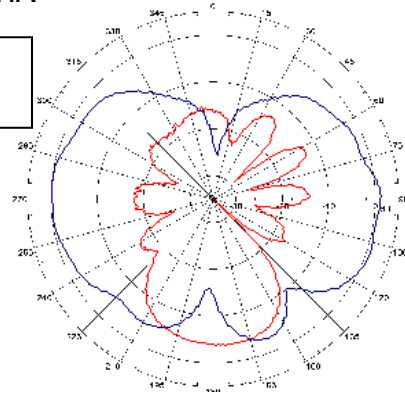

XZ cut @2.6GHz  
 — Vertical  
 ..... Horizontal

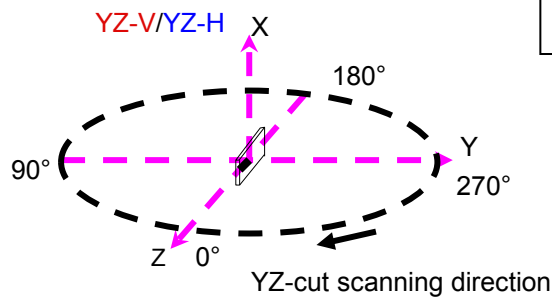
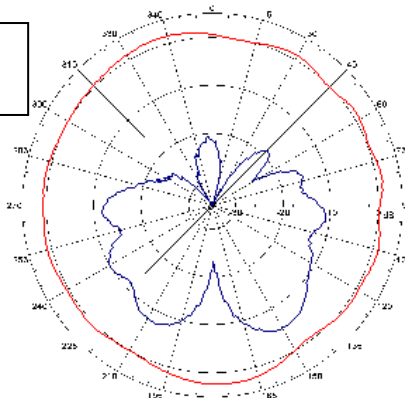

YZ cut @2.6GHz  
 — Vertical  
 ..... Horizontal

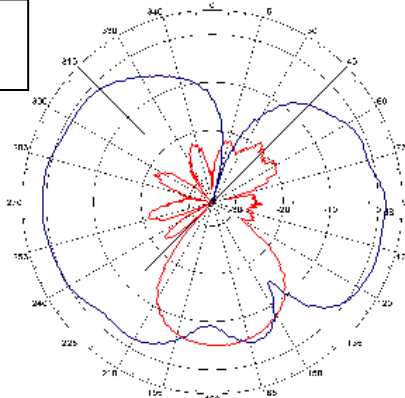

Johanson Technology, Inc. reserves the right to make design changes without notice.

All sales are subject to Johanson Technology, Inc. terms and conditions.



[www.johansontechnology.com](http://www.johansontechnology.com)

4001 Calle Tecate • Camarillo, CA 93012 • TEL 805.389.1166 FAX 805.389.1821

Ver 1.2

2013 Johanson Technology, Inc. All Rights Reserved

# "High Frequency Ceramic Solutions"

2.38GHz / 2.45GHz / 2.6GHz Wideband SMD Chip Antenna

P/N 2500AT44M0400

Designed for: BAN, Bluetooth, 802.11, WLAN, Zigbee, Proprietary Protocol, ISM, Smart Energy, WiMax

Detail Specification: 5/24/2013

Page 6 of 9

## Alternate layout - Layout #2

Mount these devices with brown mark facing up. Units: mm

\*Line width should be designed to provide 50  $\Omega$  impedance matching characteristics.

### Layout #2 example (units in mm)\*\*

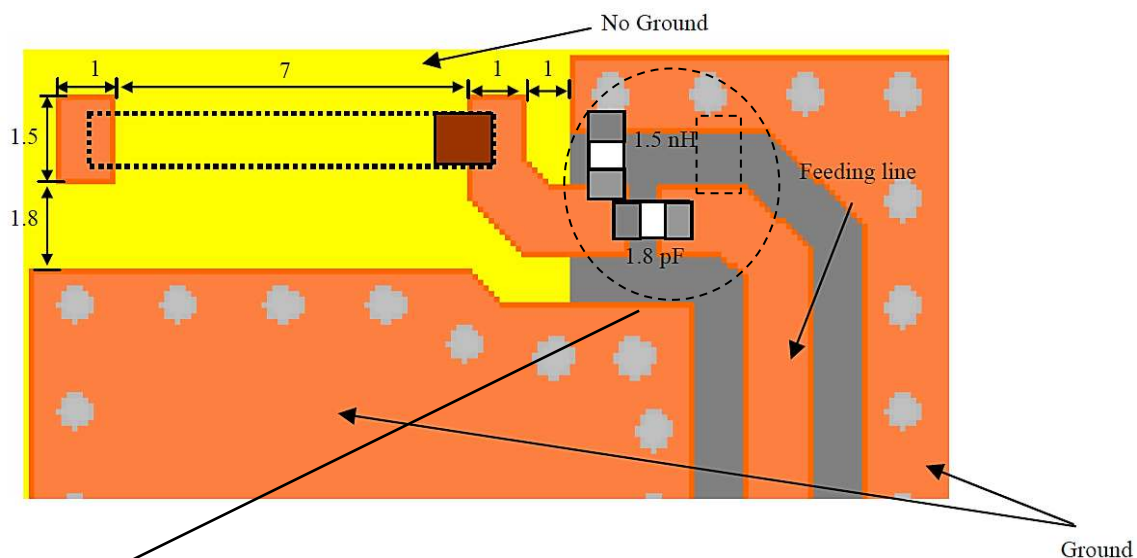

It is recommended that the designer leave available slots for a "pi" (or shunt-series-shunt) network. The antenna matching network values are used when antenna is mounted on Johanson's evaluation board. The matching values on clinet's PCB will be different.

Go to: <http://johansontechnology.com/tuning> and see how to obtain the new values.

If you need further help, contact our RF Applications Eng Team at:

[www.johansontechnology.com/en/ask-a-technical-question.html](http://www.johansontechnology.com/en/ask-a-technical-question.html)

\*\*Bandwidth is about 190MHz in this configuration

Johanson Technology, Inc. reserves the right to make design changes without notice.

All sales are subject to Johanson Technology, Inc. terms and conditions.



[www.johansontechnology.com](http://www.johansontechnology.com)  
4001 Calle Tecate • Camarillo, CA 93012 • TEL 805.389.1166 FAX 805.389.1821

Ver 1.2

2013 Johanson Technology, Inc. All Rights Reserved



# "High Frequency Ceramic Solutions"

2.38GHz / 2.45GHz / 2.6GHz Wideband SMD Chip Antenna P/N 2500AT44M0400

Designed for: BAN, Bluetooth, 802.11, WLAN, Zigbee, Proprietary Protocol, ISM, Smart Energy, WiMax

Detail Specification: 5/24/2013

Page 7 of 9

## Typical Electrical Characteristics (T=25 °C)

Test Board - Layout #2 (units in mm)

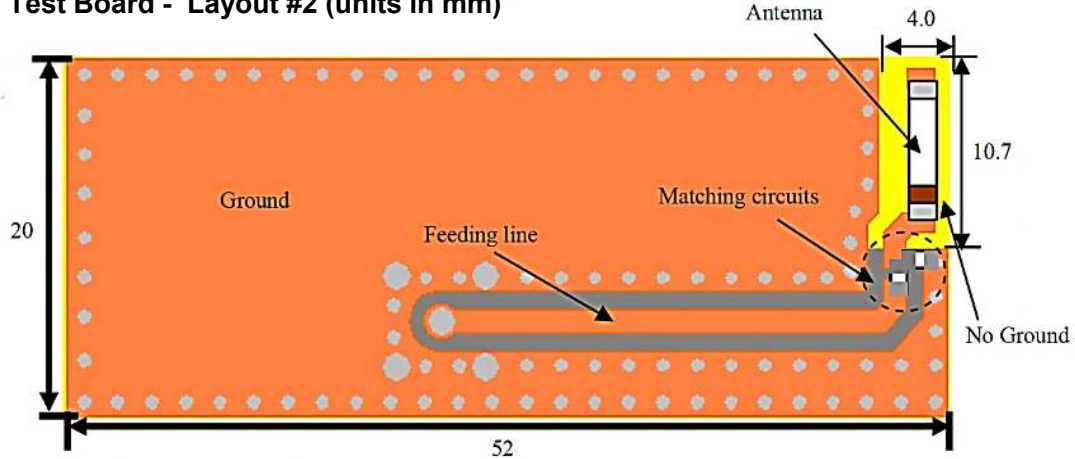

Return Loss - with Matching Circuits

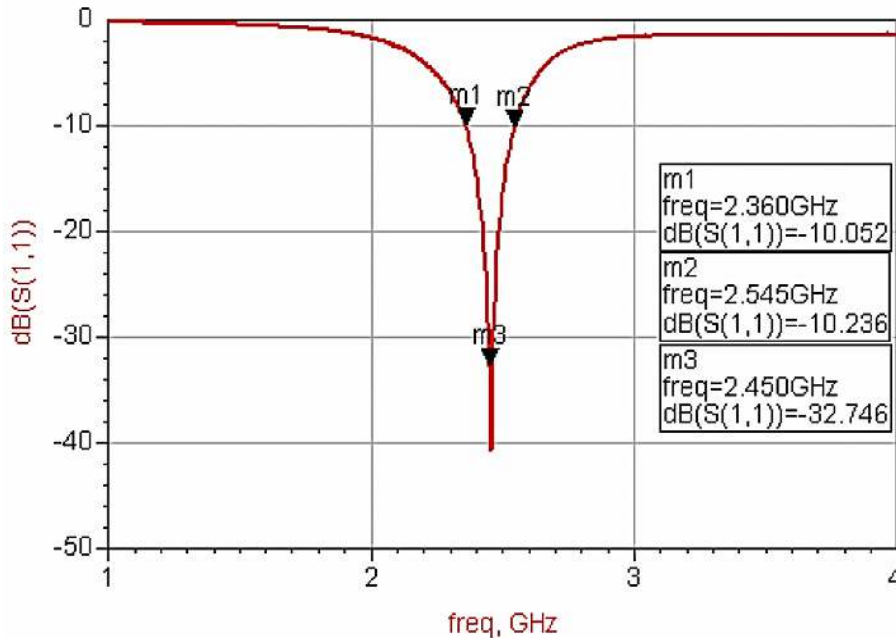

Johanson Technology, Inc. reserves the right to make design changes without notice.

All sales are subject to Johanson Technology, Inc. terms and conditions.



[www.johansontechnology.com](http://www.johansontechnology.com)

4001 Calle Tecate • Camarillo, CA 93012 • TEL 805.389.1166 FAX 805.389.1821

Ver 1.2

2013 Johanson Technology, Inc. All Rights Reserved

# "High Frequency Ceramic Solutions"

2.38GHz / 2.45GHz / 2.6GHz Wideband SMD Chip Antenna

P/N 2500AT44M0400

Designed for: BAN, Bluetooth, 802.11, WLAN, Zigbee, Proprietary Protocol, ISM, Smart Energy, WiMax

Detail Specification: 5/24/2013

Page 8 of 9

## Typical Radiation Patterns @ 2.45GHz - Layout #2

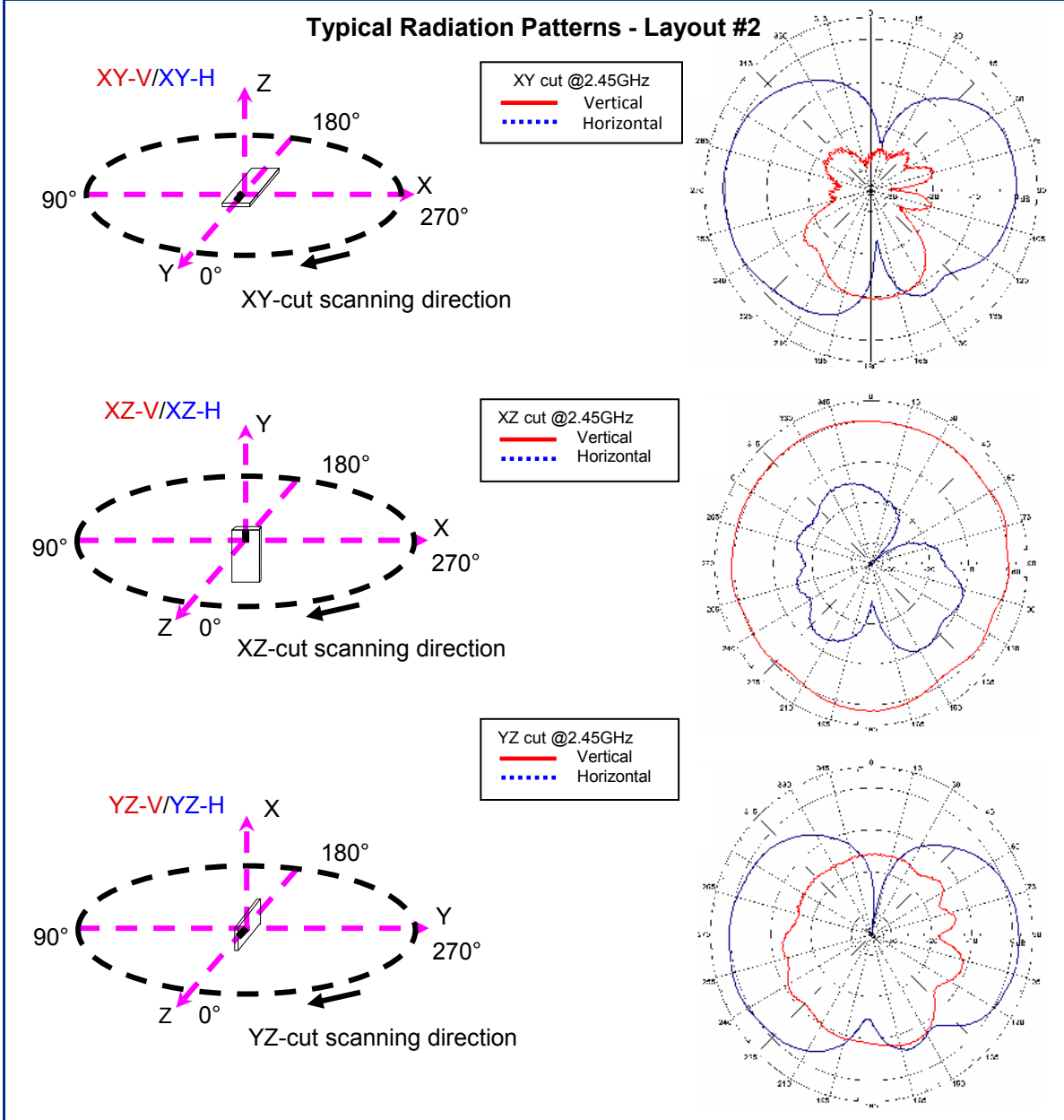

Johanson Technology, Inc. reserves the right to make design changes without notice.

All sales are subject to Johanson Technology, Inc. terms and conditions.



[www.johansontechnology.com](http://www.johansontechnology.com)

4001 Calle Tecate • Camarillo, CA 93012 • TEL 805.389.1166 FAX 805.389.1821

Ver 1.2

2013 Johanson Technology, Inc. All Rights Reserved



# "High Frequency Ceramic Solutions"

**2.38GHz / 2.45GHz / 2.6GHz Wideband SMD Chip Antenna**      **P/N 2500AT44M0400**

Designed for: **BAN, Bluetooth, 802.11, WLAN, Zigbee, Proprietary Protocol, ISM, Smart Energy, WiMax**

Detail Specification:      5/24/2013

Page 9 of 9

## Additional Info

### Part Number Explanation

P/N Suffix	Packing Style			
	Bulk	Suffix = S	eg. 2500AT44M0400S	
	T & R	Suffix = T	eg. 2500AT44M0400E	
	Evaluation Board	SMA	Suffix = -EB1SMA	eg. 2500AT44M0400-EB1SMA

### Tape & Reel Specifications

<http://www.johansontechnology.com/ipcpackaging.html>

### Soldering Profile

<http://johansontechnology.com/ipcsoldering-profile>

Johanson Technology, Inc. reserves the right to make design changes without notice.

All sales are subject to Johanson Technology, Inc. terms and conditions.



[www.johansontechnology.com](http://www.johansontechnology.com)

4001 Calle Tecate • Camarillo, CA 93012 • TEL 805.389.1166 FAX 805.389.1821

Ver 1.2

2013 Johanson Technology, Inc. All Rights Reserved