

GEN. ST.	01	02	03	04	05	06	07	08	0D	50	60	70	80	90
INT. ST.	10	11	12	13	14	18	20	31	32	33	34	38	39	40

REV.	DATE	DESCRIPTION	BY	C'K'D'
A	2001-09-14	CONVERSION REVISION 02	KN	
B	2005-05-31	105-0082	ALEX B	BKP
C	2006-07-05	106-0096	VIVEK	BKP

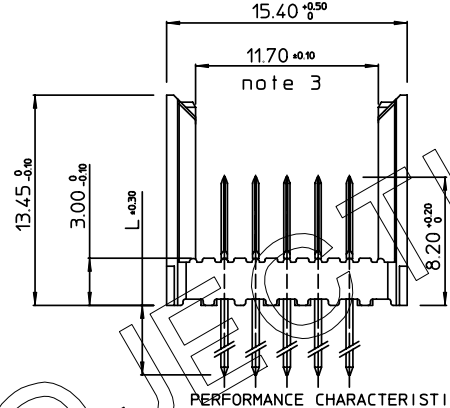
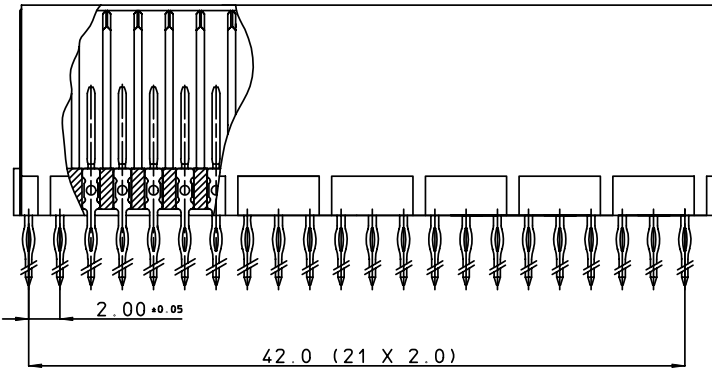

PERFORMANCE CHARACTERISTICS

1.5 A AT 20°C (FULLY LOADED)
 CURRENT RATING : 1 A AT 70°C (FULLY LOADED)
 RATED VOLTAGE : 500 V AC (CONT / CONT)
 OPERATING TEMPERATURE : -55°C TO 125°C
 CONTACT RESISTANCE : 20 mΩ MAX
 INSERTION FORCE : 0.75 N MAX / CONT
 EXTRACTION FORCE : 0.15 N MIN / CONT
 INSULATION RESISTANCE : 10⁴ MΩ MIN

CAT. NR.	L ±0.3	DESCRIPTION
HM2P66PD5110----	3.7	SHORT PRESS-FIT
HM2P66PC5110----	4.5	SHORT PRESS-FIT
HM2P66PK5110----	13	REAR PLUG-UP: LEVEL 1
HM2P66PM5110----	14.5	REAR PLUG-UP: LEVEL 2
HM2P66PN5110----	16	REAR PLUG-UP: LEVEL 3
HM2P66PT5110----	13	WIRE WRAP

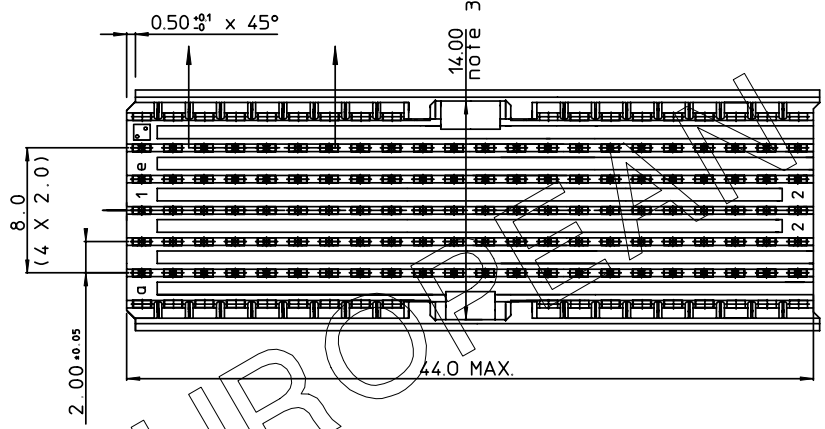

8.0
(4 X 2.0)
2.00 ±0.05

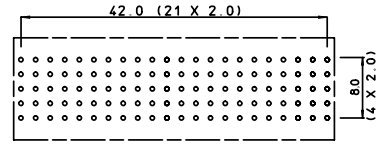



LAY-OUT P.C.B. - HOLE

NOTES

- PERFORMANCE LEVEL INDICATION: (DIGIT 15 & 16)(REF DWG No. BS,C ,201844,003)
- LEAD FREE INDICATOR: LF-LEAD FREE (DIGIT 15 & 16)
- THIS PRODUCT IS CSA APPROVED. THIS PRODUCT IS UL RECOGNIZED.
- MEASURED AT THE BOTTOM.
- THIS PRODUCT (LF) MEETS EUROPEAN UNION DIRECTIVES AND OTHER COUNTRY REGULATIONS AS DESCRIBED IN GS-22-008
- FOR PTH DETAILS REFER DRAWING : BS,A ,201572,001

MALE SIGNAL STRAIGHT PRESS-FIT-TO-BOARD CONNECTOR

WITH GUIDING		APPR.	DATE	SGN.	MILLIPACS 2 / TYPE AB (22 POS) / NO SHIELDING
1DEC ±0.2					
2DEC ±0.1					
ANGLES ±1°					
DRAFT CHECKED			1999-05-06	N.Otto	CAT. No. HM2P66P#5110----
WE RESERVE THE RIGHT TO CHANGE DIMENSIONS OR REQUIREMENTS WITHOUT PRIOR NOTICE.		PROD. MGR.			 www.fciconnect.com
ALL DIMENSIONS IN MM		PR. ENG. MGR.			
		PR. MGT. MGR.			

 	REFERENCES	BS,C ,201632,032	C
		DRAWING No.	REVISION
		CUSTOMER DRAWING	

THIS IS OUR EXCLUSIVE PROPERTY. IT IS NOT TO BE COPIED, REPRINTED OR DISCLOSED TO A THIRD PARTY. NOR USED FOR MANUFACTURING WITHOUT OUR WRITTEN CONSENT, AND HAS TO BE RETURNED TO US IN CASE OF NO USAGE

DIT IS ONZE EIGENDOM EN MAG NOCH NAGEMAAKT, HERDRUKT, OVERGEDRAAGT AAN DERDEN. NOCH VOOR FABRIKATIE GEBRUIKT WORDEN, ZONDER ONZE SCHRIFTELIJKE TOELATING. BIJ NIET GEBRUIK IS TERUGZENDING VERPLICHT.