

1.5A Step-Up Current Regulator for Flash LEDs**General Description**

The AAT1271 is a high-efficiency, high-current boost converter capable of 1.5A typical output current. It is an ideal power solution for LED photo flash applications in all single cell Li-ion powered products.

The AAT1271 maintains output current regulation by switching the internal high-side and low-side switch transistors. The transistor switches are pulse-width modulated at a fixed frequency of 2MHz. The high switching frequency allows the use of a small inductor and output capacitor, making the AAT1271 ideally suited for small battery-powered applications.

Skyworks' proprietary AS²Cwire™ (Advanced Simple Serial Control™) serial digital interface is used to enable, disable, configure, and program the operation of the AAT1271. Using the AS²Cwire interface, the movie-mode current level for each LED, the safety timer delay, and the flash-to-movie-mode current ratio can be programmed to one of 16 levels. In addition, the single-wire serial protocol sets output channel control. The AAT1271 also includes a separate Flash Enable input to initiate both the flash operation and the default timer which can be used either to terminate a flash event at the end of a user-programmed delay or as a safety feature. Also included is a Flash Inhibit pin which reduces the flash current to movie-mode levels during high battery demand.

The maximum flash and movie-mode current is set by one external resistor where the ratio of Flash to Movie-mode current is set at approximately 7.3:1. One or two LEDs can be connected to the AAT1271, where in the case of two LEDs the output current is matched between each diode.

The AAT1271 contains a thermal management system to protect the device in the event of an output short-circuit condition. Built-in circuitry prevents excessive inrush current during start-up. The shutdown feature reduces quiescent current to less than 1.0µA.

The AAT1271 is available in a Pb-free, thermally-enhanced 14-pin 3x3mm TDFN package.

Features

- V_{IN} Range: 2.7V to 5.5V
- Dual Channel Output
- Up to 1.5A Regulated Output Current (750mA per channel)
- Up to 85% Efficiency with Small Inductor (1µH)
- 2 MHz Switching Frequency
- Separate Flash Enable
- Separate Flash Inhibit
- User-Programmable Safety Timer
- Single Resistor Sets Flash and Movie Mode Current
- AS²Cwire Single Wire Programming:
 - Movie Mode Current
 - Flash/Movie Mode Current Ratio
 - Movie Mode Output Configuration
 - Flash Safety Timer
- True Load Disconnect
- Input Current Limit
- Over-Voltage (Open LED, Open Circuit), Short Circuit, and Over-Temperature Protection
- Shutdown Current < 1.0µA
- 14-pin TDFN 3x3 mm Package
- -40°C to +85°C Temperature Range

Applications

- Camcorder Video Light (Torch Light)
- Cellphones/Smartphones
- Digital Still Cameras (DSCs)
- LED Photo Flash/Torch
- Mobile Handsets

1.5A Step-Up Current Regulator for Flash LEDs

Typical Application

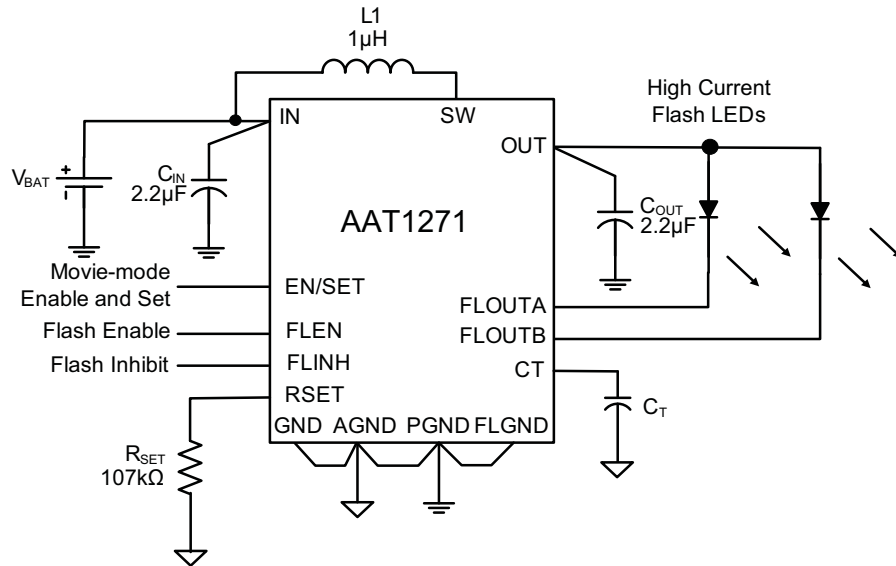

Pin Descriptions

Pin #	Symbol	Function
1	CT	Flash timer control input. Connect a capacitor between CT and AGND to set maximum duration of the flash pulse. To disable the flash timer, connect CT to AGND.
2	EN/SET	Enable and Serial Control input. EN/SET is the AS ² Cwire addressing and programming input to: a) adjust the movie-mode current level; b) program the flash timer based on CT; c) select the Flash-to-Movie-mode ratio; and d) select FLOUTA and FLOUTB's output configuration.
3	FLEN	Flash enable pin. A low-to-high transition on the FLEN pin initiates a flash pulse and starts the flash timer.
4	AGND	Analog ground pin. Connect AGND to PGND, GND, and FLGND at a single point as close to the AAT1271 as possible.
5	IN	Power input. Connect IN to the input power supply voltage. Connect a 2.2µF or larger ceramic capacitor from IN to PGND as close as possible to the AAT1271.
6	SW	Boost converter switching node. Connect a 1µH inductor between SW and IN.
7	PGND	Power ground pin. Connect PGND to AGND, GND, and FLGND at a single point as close to the AAT1271 as possible.
8	OUT	Power output of the boost converter. Connect a 2.2µF or larger ceramic capacitor from OUT to PGND as close as possible to the AAT1271. Connect OUT to the anode(s) of the Flash LED(s).
9	GND	Ground pin. Connect GND to PGND, AGND, and FLGND at a single point as close to the AAT1271 as possible.
10	FLINH	Flash inhibit pin. FLINH is an active HIGH control input with an internal 200kΩ resistor to AGND. A low-to-high transition on the FLINH pin reduces FLOUTA and FLOUTB output currents to the maximum (default) movie-mode current level for the duration of FLINH. Strobing the FLINH pin low to high does not reset the flash timer.
11	FLOUTB	Flash Output B. Connect cathode of Flash LEDB to FLOUTB. For a single flash LED, connect FLOUTB & FLOUTA together. For two flash LEDs, each output will conduct 50% of the total flash output current.
12	FLGND	Flash ground pin. Connect FLGND to PGND, GND, and AGND at a single point as close to the AAT1271 as possible.
13	FLOUTA	Flash Output A. Connect cathode of Flash LEDA to FLOUTA. For a single flash LED, connect FLOUTA and FLOUTB together. For two flash LEDs, each output will conduct 50% of the total flash output current.
14	RSET	Flash current setting input. A 107kΩ resistor from RSET to AGND sets the maximum flash current available at FLOUTA and FLOUTB to 1.5A. Each FLOUTA and FLOUTB channel will conduct 50% of the maximum programmed current. The AAT1271's flash-to-movie-mode ratio is fixed at 7.3:1.
EP		Exposed paddle (bottom); Connect EP to PGND as close as possible to the AAT1271.

1.5A Step-Up Current Regulator for Flash LEDs

Pin Configuration

**TDFN33-14
(Top View)**

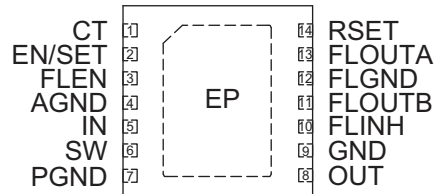

Absolute Maximum Ratings¹

(T_A = 25°C unless otherwise noted.)

Symbol	Description	Value	Units
IN, SW, OUT	Maximum Rating	-0.3 to 6.0	V
RSET, EN/SET, FLEN, FLINH, CT, FLOUTA, FLOUTB	Maximum Rating	V _{IN} + 0.3	V
T _J	Operating Temperature Range	-40 to 150	°C
T _s	Storage Temperature Range	-65 to 150	°C
T _{LEAD}	Maximum Soldering Temperature (at leads, 10 sec)	300	°C

Recommended Operating Conditions

Symbol	Description	Value	Units
θ _{JA}	Thermal Resistance	50	°C/W
P _D	Maximum Power Dissipation	2	W

1. Stresses above those listed in Absolute Maximum Ratings may cause permanent damage to the device. Functional operation at conditions other than the operating conditions specified is not implied. Only one Absolute Maximum Rating should be applied at any one time. The AAT1271 is guaranteed to meet performance specifications over the -40°C to +85°C operating temperature range and is assured by design, characterization, and correlation with statistical process controls.

1.5A Step-Up Current Regulator for Flash LEDs

Electrical Characteristics¹

$V_{IN} = 3.6V$; $C_{IN} = 2.2\mu F$; $C_{OUT} = 2.2\mu F$; $L = 1\mu H$; $R_{SET} = 107k\Omega$; $T_A = -40^\circ C$ to $85^\circ C$, unless otherwise noted. Typical values are $T_A = 25^\circ C$.

Symbol	Description	Conditions	Min	Typ	Max	Units
Power Supply						
V_{IN}	Input Voltage Range		2.7		5.5	V
$V_{OUT(MAX)}$	Maximum Output Voltage				5.5	V
$I_{IN(Q)}$	Supply Current	EN/SET = FLEN = IN, Set FL Load = 1.5A		0.67	1	mA
		EN/SET = IN, FLEN = AGND		0.23		
$I_{SHDN(MAX)}$	V_{IN} Shutdown Current	EN/SET = FLEN = FLINH = GND			1	μA
$I_{FL(TOTAL)}$	Total Output Current, Flash Mode	$R_{SET} = 107k\Omega$; FLOUTA + FLOUTB	1.2	1.5		A
$I_{FL(MATCH)}$	FLOUTA and FLOUTB Current Matching			10		%
$I_{MM(LOAD)}$	Total Output Current, Movie Mode	$R_{SET} = 107k\Omega$, Movie Mode Current Set = 100%; FLOUTA + FLOUTB		206		mA
I_{FL}	FLOUTA/FLOUTB Current Accuracy	FLOUTA + FLOUTB = 1.2A	-10		10	%
f_{OSC}	Switching Frequency	$T_A = 25^\circ C$	1.5	2.0	2.5	MHz
$t_{DEFAULT}$	Default ON Time	$C_T = 74nF$		600		ms
T_{SD}	Thermal Shutdown Threshold			140		$^\circ C$
$T_{SD(HYS)}$	Thermal Shutdown Hysteresis			15		$^\circ C$
EN/SET/ FLEN/ FLINH Logic Control						
$V_{EN/SET(L)}$, $V_{FLEN(L)}$	EN/SET, FLEN Input Low Threshold				0.4	V
$V_{EN/SET(H)}$, $V_{FLEN(H)}$	EN/SET, FLEN Input High Threshold		1.4			V
$I_{EN/SET}$, I_{FLEN}	EN/SET or FLEN Input Leakage Current	$FL_{EN}/V_{EN/SET} = V_{IN} = 5V$	-1		1	μA
$V_{T(FLINH)}$	FLINH Input Threshold Voltage			$\frac{1}{2}V_{IN}$		V
$R_{IN(FLINH)}$	FLINH Input Resistance to AGND			200		$k\Omega$
$t_{EN/SET(LOW)}$	EN/SET Serial Interface Low Time		0.3		75	μs
$t_{EN/SET(HI_MIN)}$	Minimum EN/SET high Time			50		ns
$t_{EN/SET(HI_MAX)}$	Maximum EN/SET High Time				75	μs
$t_{EN/SET(OFF)}$	EN/SET Off Timeout				500	μs
$t_{EN/SET(LAT)}$	EN/SET Latch Timeout				500	μs
t_{FLEN_ON}	FLEN ON Delay Time	EN/SET = GND		40		μs
t_{FLEN_OFF}	FLEN OFF Delay Time	EN/SET = GND		10		μs
t_{FLINH_ON}	FLINH ON Delay Time			93		μs
t_{FLINH_OFF}	FLINH OFF Delay Time			5		μs

1. The AAT1271 is guaranteed to meet performance specifications over the $-40^\circ C$ to $+85^\circ C$ operating temperature range and is assured by design, characterization, and correlation with statistical process controls.

1.5A Step-Up Current Regulator for Flash LEDs

Typical Characteristics

Flash Mode Efficiency vs. Input Voltage

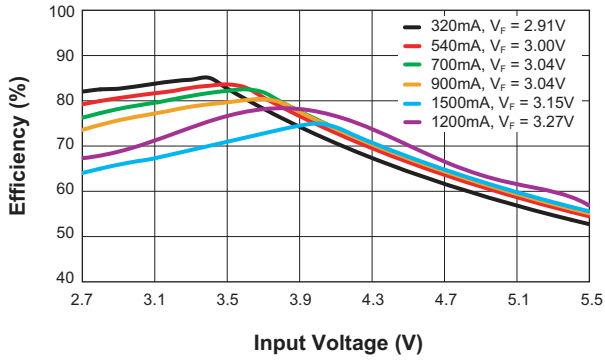

Movie Mode Efficiency vs. Input Voltage

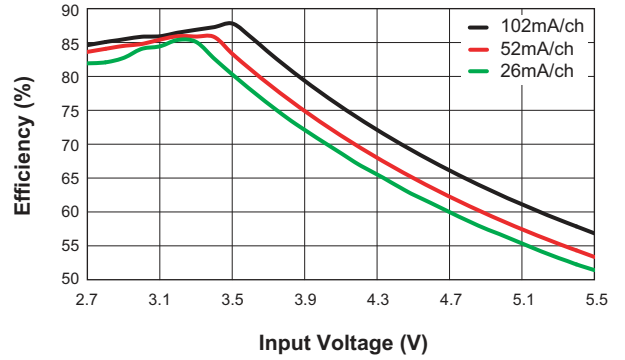

Boost Switching Frequency vs. Input Voltage
(Movie Mode; $L = 1\mu H$)

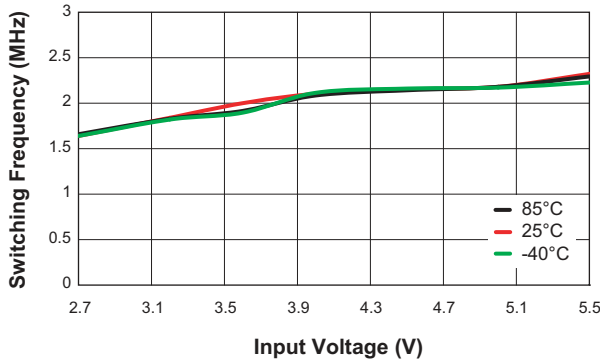

Shutdown Current vs. Input Voltage
($V_{EN/SET} = V_{FLEN} = 0V$)

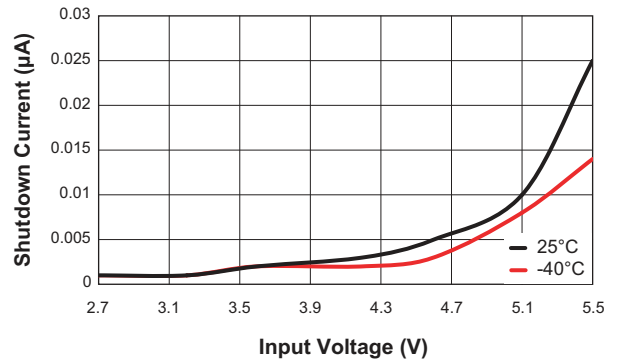

Supply Current vs. Input Voltage
($V_{EN} = V_{FLEN} = 3.6V$)

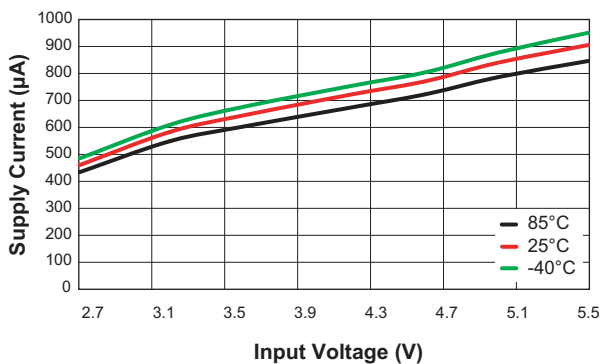

Movie Mode Current vs. Temperature
($I_{FLOUTX} = 103mA/Ch$; $V_{IN} = 3.6V$; $L = 1\mu H$)

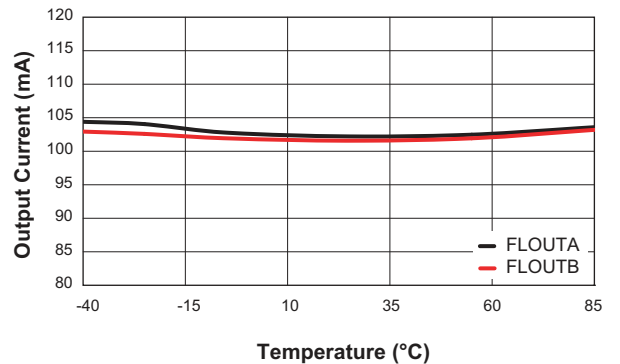

1.5A Step-Up Current Regulator for Flash LEDs

Typical Characteristics

Movie Mode LED Current Accuracy vs. Input Voltage
($I_{FLOUTX} = 103\text{mA/Channel}$; $L = 1\mu\text{H}$)

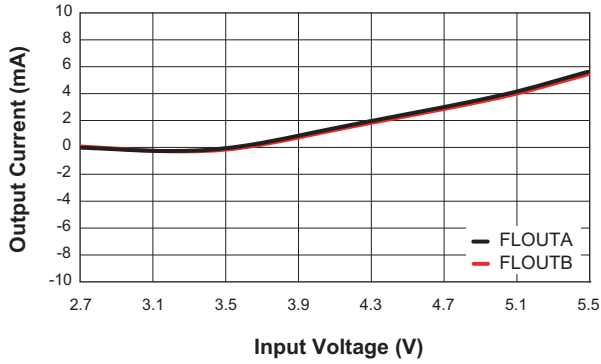

Movie Mode Output Ripple
($I_{FLOUTX} = 103\text{mA/ch}$; $V_{IN} = 3.6\text{V}$; $L = 1\mu\text{H}$)

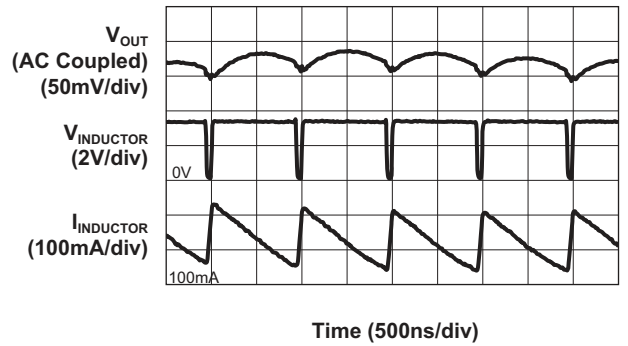

Flash Mode Output Ripple
($I_{FLOUTX} = 750\text{mA/ch}$; $V_{IN} = 4\text{V}$; $L = 1\mu\text{H}$)

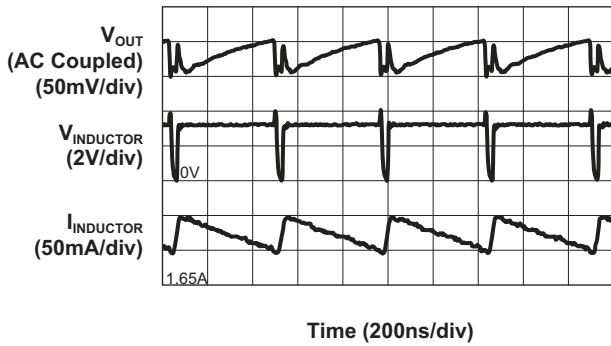

Flash LED Current Matching vs. Temperature
($I_{FLOUTX} = 750\text{mA/Ch}$; $V_{IN} = 4.2\text{V}$; $L = 1\mu\text{H}$)

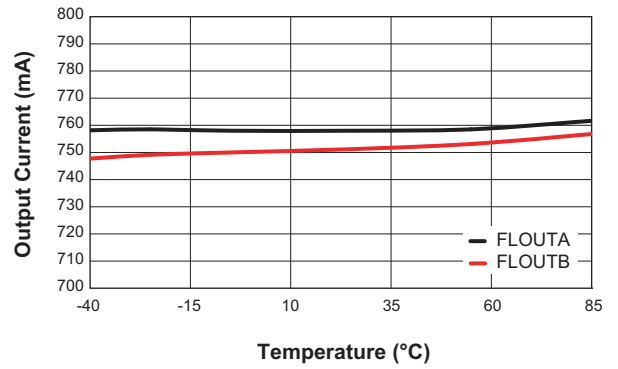

Flash On Time Delay vs. Input Voltage
($I_{FLOUTX} = 750\text{mA/ch}$; $C_{OUT} = 2.2\mu\text{F}$; $L = 1\mu\text{H}$)

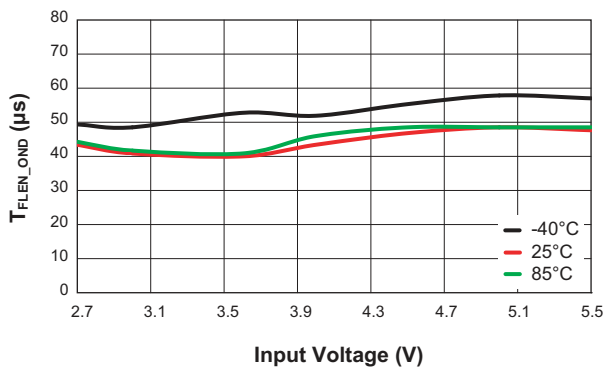

Flash Timeout Delay vs. C_T Capacitor
($I_{FLOUTX} = 750\text{mA/ch}$; $V_{IN} = 3.6\text{V}$)

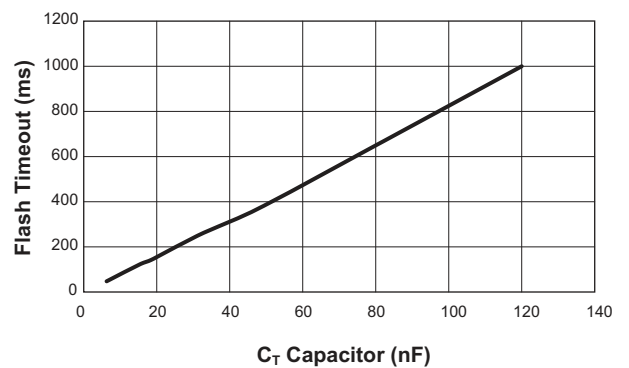

1.5A Step-Up Current Regulator for Flash LEDs

Typical Characteristics

Movie Mode Line Transient
 ($I_{FLOUTX} = 103\text{mA}/\text{ch}$; $V_{IN} = 4.2\text{V}$ to 3.6V)

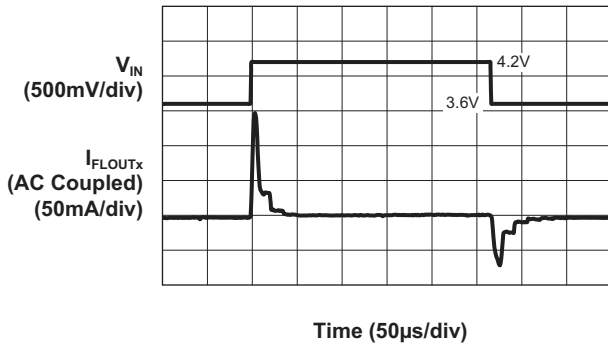

Flash Turn On Characteristic
 ($I_{FLOUTX} = 750\text{mA}/\text{ch}$; $V_{IN} = 3.6\text{V}$; $L = 1\mu\text{H}$)

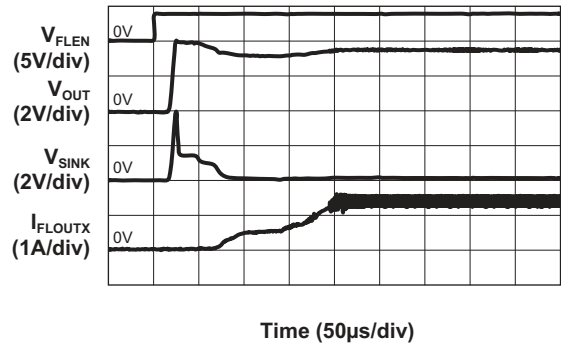

Movie Mode to Flash Turn On Characteristic
 ($I_{FLOUTX} = 103\text{mA}$ to $750\text{mA}/\text{ch}$; $V_{IN} = 3.6\text{V}$; $L = 1\mu\text{H}$)

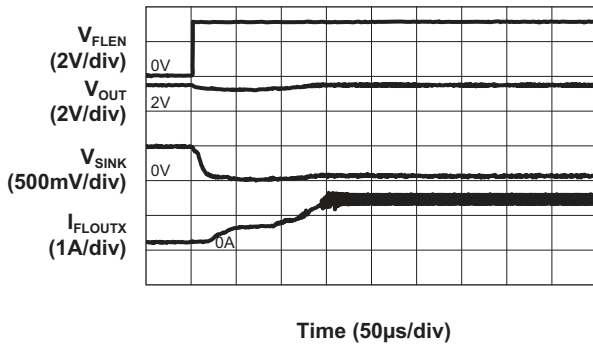

Movie Mode Turn On Characteristic
 ($I_{FLOUTX} = 103\text{mA}/\text{ch}$; $V_{IN} = 3.6\text{V}$; $L = 1\mu\text{H}$)

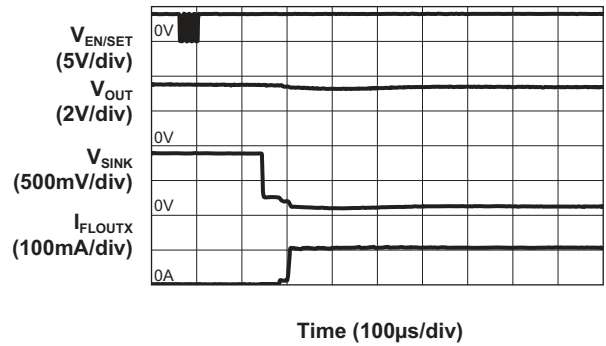

Movie Mode Transition Characteristic
 ($I_{FLOUTX} = 103\text{mA}$ to $188\text{mA}/\text{ch}$; $C_{OUT} = 0.22\mu\text{F}$;
 $V_{IN} = 3.6\text{V}$; $L = 1\mu\text{H}$)

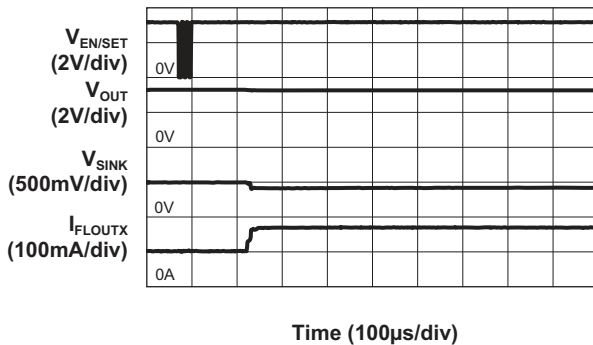

Flash Timeout vs. Temperature
 ($I_{FLOUTX} = 750\text{mA}/\text{ch}$; $V_{IN} = 3.6\text{V}$; $C_T = 47\text{nF}$)

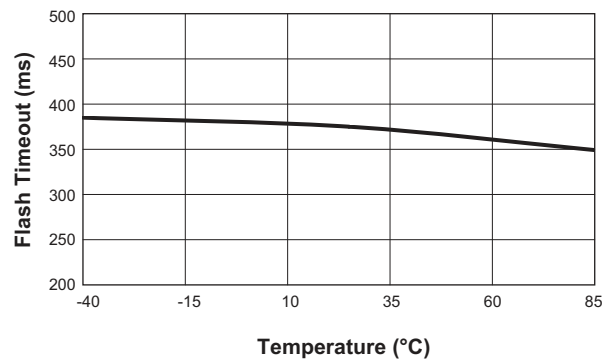

1.5A Step-Up Current Regulator for Flash LEDs

Typical Characteristics

EN, FLEN High Threshold Voltage vs. Input Voltage

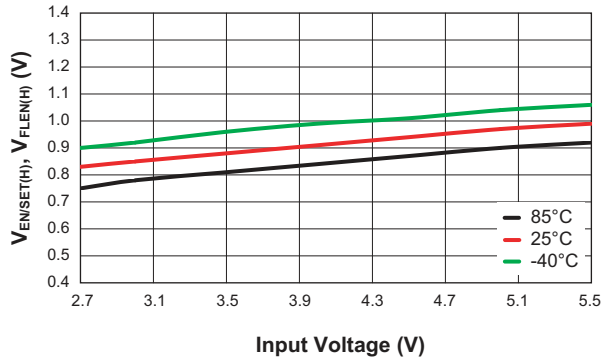

EN, FLEN Low Threshold Voltage vs. Input Voltage

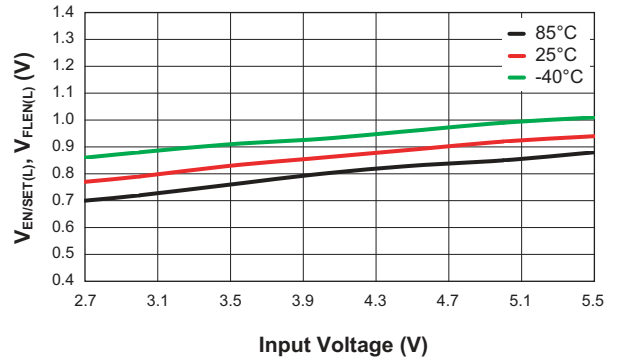

EN/SET Off Timeout vs. Input Voltage

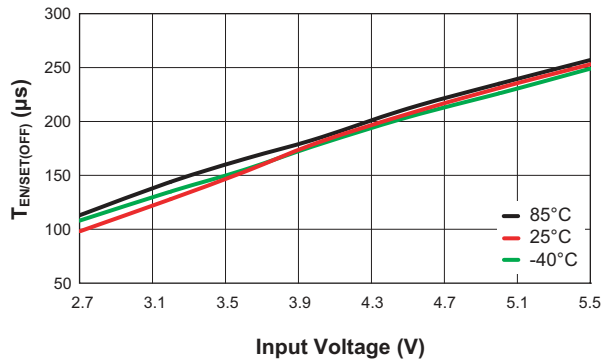

EN/SET Latch Timeout vs. Input Voltage

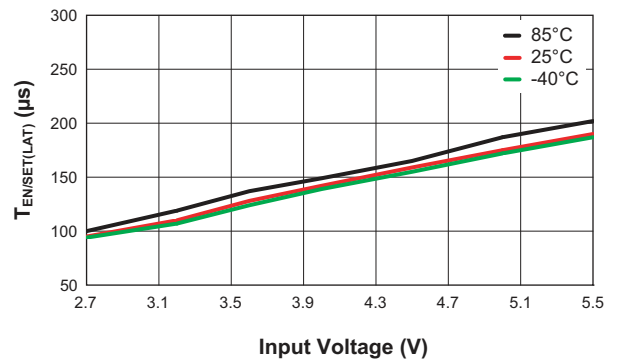

1.5A Step-Up Current Regulator for Flash LEDs

Functional Block Diagram

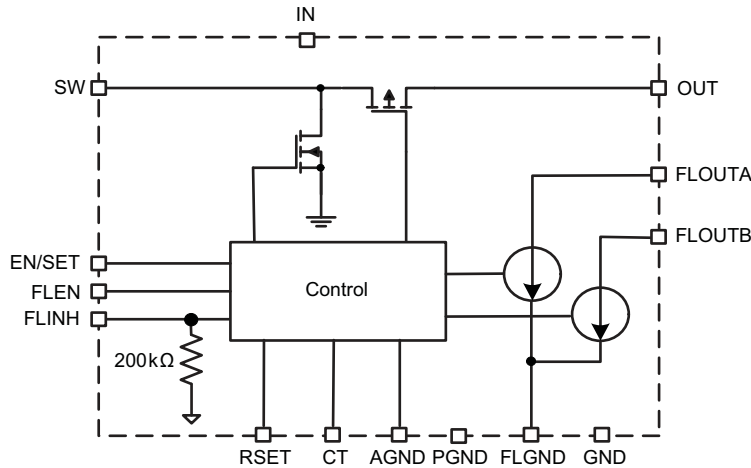

Functional Description

The AAT1271 is a boost converter with a current regulated output designed to drive high current white LEDs used in camera flash applications. The AAT1271 has two channels to accurately regulate the current flow through two separate white LEDs. There are two basic modes of operation in the AAT1271; a Flash mode controlled by the FLEN pin and the movie mode controlled through the AS²Cwire interface.

Flash Mode

A flash pulse is initiated by strobing the FLEN input pin low-to-high, which initiates a flash pulse and also starts the internal timer. The maximum flash current in the AAT1271 is set by an external resistor, R_{SET} , which sets the flash current and the maximum movie-mode current reduced by a factor of 2. The flash timer will terminate the flash current regardless of the status of the FLEN pin. This can be either used as a simple flash timing pulse or can be used as a safety timer in the event of a control logic malfunction to prevent the LED from over-heating.

The maximum flash time is determined by an external timing capacitor connected to the CT pin. The flash duration can be set from 50ms up to a maximum of 1s. The AS²Cwire interface allows further adjustment of the flash timer duration. This allows the flash timer duration to be reduced in 16 linear steps from the maximum time set by the timing capacitor. If the safety timer is not needed in the application, it can be disabled by connecting the CT pin directly to AGND.

The AAT1271 has two LED current sources which share the output current equally. For a single white LED application, the two current sources can be connected together to apply full output current into the LED. In two LED applications, each diode can be connected to its corresponding current source (FLOUTA or FLOUTB) and the output current will be shared. In applications where only one LED is connected to either FLOUTA or FLOUTB, the unused current sink must be directly connected to OUT, thereby disabling that channel.

In mobile GSM systems where the phone remains in constant contact with the base station by regular communication, a FLINH pin is provided to prevent both the camera flash and PA transmission pulses from occurring simultaneously. This avoids potential dips to the Li-ion battery voltage below the system's undervoltage lockout threshold (UVLO). During a flash event, strobing the FLINH pin low-to-high reduces the LED current to the default movie-mode current level for the duration of FLINH. Strobing FLINH high-to-low instructs the AAT1271 to revert the flash LED current to its maximum level, assuming that the FLEN pin is still active (HIGH) and the flash timer has not expired.

Movie Mode

The movie mode current level, channel enable, and the flash to maximum movie mode current ratio are set using the AAT1271's AS²Cwire interface at the EN/SET pin. The movie-mode current level can be adjusted in 16 steps using a logarithmic scale where each code is 1dB below the previous code. Channel current outputs (FLOUTA and FLOUTB) in movie-mode can be enabled or

1.5A Step-Up Current Regulator for Flash LEDs

disabled individually or together. Lastly, the flash to maximum movie mode current ratio can be set from 1:2 to 1:30 with respect to the maximum programmed flash current. The FLEN signal takes priority over movie-mode operation.

Movie mode operation is controlled entirely by the AS²Cwire interface via the EN/SET pin. Address 2 controls the movie mode on and off functions. Using this register either or both of the LED channels can be turned on to the current values set in Address registers 0 and 3. The movie mode is not operational when the FLEN pin is high and the part is in flash mode operation. If the AAT1271 is in movie mode (FLEN=low) and the FLEN is strobed high the movie mode state will end and the part will operate in the flash mode. The part will not reenter movie mode when ENFL is brought low. To reenter movie mode after a flash event the part must be turned off and the AS²Cwire interface must be reprogrammed to the desired movie mode level.

Over-Temperature Protection

Thermal protection disables the AAT1271 when internal power dissipation becomes excessive, as it disables both MOSFETs. The junction over-temperature threshold is 140°C with 15°C of temperature hysteresis. The output

voltage automatically recovers when the over-temperature fault condition is removed.

Over-Voltage Protection (Open LED, Open Circuit)

The AAT1271's output voltage is limited by internal over-voltage protection circuitry, which prevents damage to the AAT1271 from open LED or open circuit conditions. During an open circuit, the output voltage rises and reaches 5.5V (typical), and the OVP circuit disables the switching, preventing the output voltage from rising higher. Once the open circuit condition is removed, switching will resume. The controller will return to normal operation and maintain an average output voltage.

Auto-Disable Feature

The AAT1271 is equipped with an auto-disable feature for each LED channel. After the IC is enabled and started up, a test current of 2-3mA (typical) is forced through each sink channel. The channel will be disabled if the voltage of that particular SINK pin does not drop to a certain threshold. This feature is very convenient for disabling an unused channel or during an LED fail-short event. This small test current should be added to the set output current in both Flash and MM conditions.

Timing Diagram

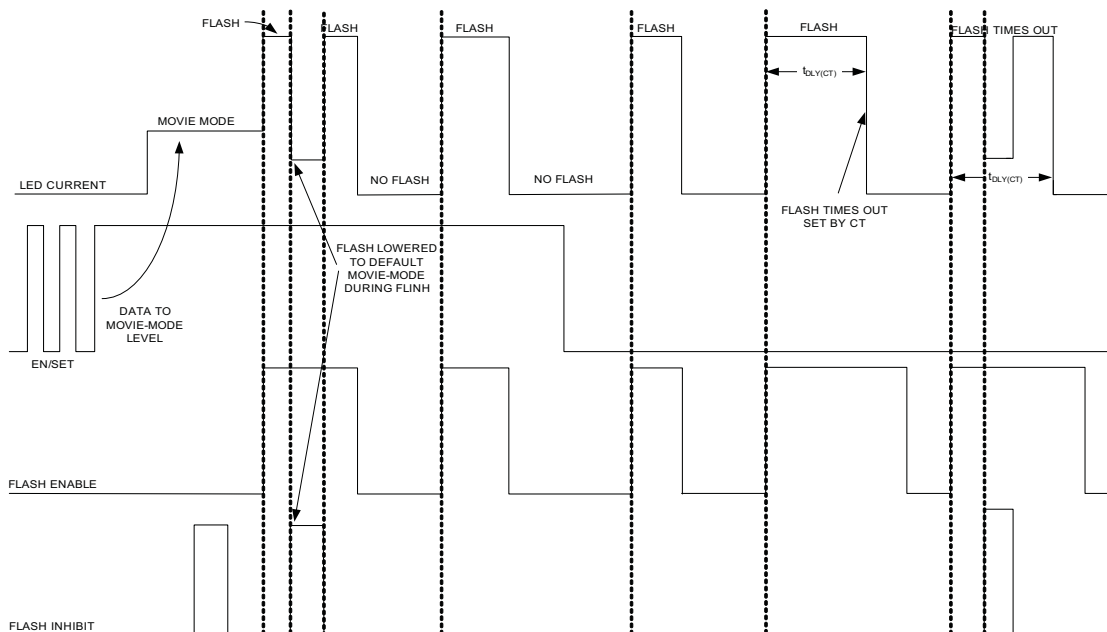

No AS²C address programming shown.

1.5A Step-Up Current Regulator for Flash LEDs

Applications Information

LED Selection

The AAT1271 is specifically designed to drive white flash LEDs (typical forward voltage of 2.5V to 4.0V). Since the FLOUTA and FLOUTB input current sinks are matched with low voltage dependence; the LED-to-LED brightness will be matched regardless of the individual LED forward voltage (V_F) levels.

Flash Mode LED Current

FLOUTA and FLOUTB can be programmed up to a maximum total flash current of 1.5A or up to 750mA per channel. The output currents in FLOUTA and FLOUTB are equal.

The maximum flash current in each FLOUTA and FLOUTB is set by the R_{SET} resistor. For the desired flash current in each output, the resistor value can be calculated using the following equation:

$$I_{FLOUTA} = I_{FLOUTB} = \frac{81k\Omega \times A}{R_{SET}} = \frac{81k\Omega \times A}{107k\Omega} = 750\text{mA per channel}$$

A flash event is initiated by asserting the FLEN pin. A flash event is automatically terminated when FLEN is de-asserted or if the safety timer terminates before the FLEN pin is de-asserted. Any time that the FLINH pin is asserted, the default movie-mode current level will appear at both FLOUTA and FLOUTB. The default movie-mode current level will be maintained on FLOUTA and FLOUTB as long as the FLINH and FLEN pins are asserted, and the safety timer continues to run.

In addition to setting the flash current via R_{SET} , the flash current can be changed after FLEN is asserted by programming the movie mode current register with 16 different steps.

AS²Cwire Control of Movie Mode Operation and Flash Safety Timer

In the AAT1271 control of the movie mode operation and flash timer is managed by the Advanced Simple Serial Control (AS²Cwire) interface. AS²Cwire relies on the number of rising edges of the EN/SET pin to address and load the AAT1271's registers. As shown in Table 1, Address 0 controls the Movie Current level as a percentage of the maximum movie mode current level. Address 1 controls the safety timer duration as a percentage of the maximum value set by an external timing capacitor. Address 2 enables the two LED channels independently during movie mode. Finally, Address 3 sets the maximum possible current for movie mode operation. The maximum movie mode current is set as a fraction of the flash current with peak value of 1/2 and default value of 1/7.3. The last column in Table 1 shows the default values for each of the address registers.

AS²Cwire Serial Interface

AS²Cwire latches data or address after the EN/SET pin has been held high for longer than t_{LAT} (500 μ s). Address or data is differentiated by the number of EN/SET rising edges. Since the data registers are 4 bits each, the differentiating number of pulses is 2^4 or 16, so that Address 0 is signified by 17 rising edges, Address 1 by 18 rising edges and Address 2 by 19 rising edges and Address 3 by 20 rising edges. Data is applied to any number of rising edges between 1 and 16, inclusive. A typical write protocol is a burst of EN/SET rising edges, signifying a particular address, followed by a pause with EN/SET held high for the prescribed t_{LAT} timeout period, a burst of rising edges signifying data, and a t_{LAT} timeout for the data registers. Once an address is set, then multiple writes to the corresponding data register are allowed. Address 0 is the default address on the first rising edge after the AAT1271 has been disabled.

Address	EN/SET Rising Edges	Function	Default (No programming)
0	17	Movie Mode Current	100%
1	18	Flash Safety Timer	16/16
2	19	Movie Mode Output Configuration	FLOUTA and FLOUTB OFF
3	20	Flash/Movie Mode Current Ratio	1/7.3

Table 1: AS²Cwire Serial Interface Addressing.

1.5A Step-Up Current Regulator for Flash LEDs

When EN/SET is strobed low and held low longer than t_{OFF} (500 μ s), the AAT1271 enters shutdown mode and draws less than 1 μ A from V_{IN} . All data and address are cleared (reset to 0) during shutdown.

The AS²Cwire addressing allows the control of the movie-mode output current, the safety timer delay, independent control of the FLOUTA and FLOUTB current sinks, and the ratio of movie-mode current to flash current.

If there are no programmed write instructions applied to the EN/SET pin prior to the assertion of the FLEN pin and the device is enabled, then all registers will be loaded with their default values shown in Table 1. In the event that the number of rising edges applied at the EN/SET pin is less than 17, the AAT1271's state machine will interpret instruction to program the output currents to the desired current level for movie-mode operation.

Movie Mode Current – Address 0

The AAT1271 movie mode current settings are controlled using the AS²Cwire interface. Movie Mode current has a maximum value of 50% of the flash current with 240 possible current levels. The maximum movie mode current is set by Address register 3 (discussed below). The default ratio between the flash current level and maximum movie mode current level is 1:7.3. The corresponding FLOUTA/FLOUTB maximum movie mode current can be calculated:

$$I_{MOVIE\ MODE[A/B]} = \frac{I_{FLOUTA/B\ MAX}}{7.3}$$

For example, if an R_{SET} value of 107k Ω is chosen, then the FLOUTA/FLOUTB flash current is set to 750mA. For

movie mode operation, the maximum current available at either FLOUTA or FLOUTB is then:

$$I_{MOVIE\ MODE[A/B]} = \frac{I_{FLOUTA/B\ MAX}}{7.3} = \frac{750mA}{7.3} = 103mA$$

Address 0 controls precise movie mode current levels. The FLOUTA/FLOUTB movie-mode current can be adjusted in logarithmic fashion to one of 16 steps represented as a fraction of the maximum movie mode current in Table 2. To adjust the movie-mode current the user must first access Address 0 before writing the data to set the MM Current value.

Data	Percentage of Maximum MM Current
1*	100%
2	89%
3	79%
4	71%
5	63%
6	56%
7	50%
8	45%
9	40%
10	36%
11	32%
12	28%
13	25%
14	22%
15	20%
16	0%

Table 2: Address 0, Movie Mode Current Programming.

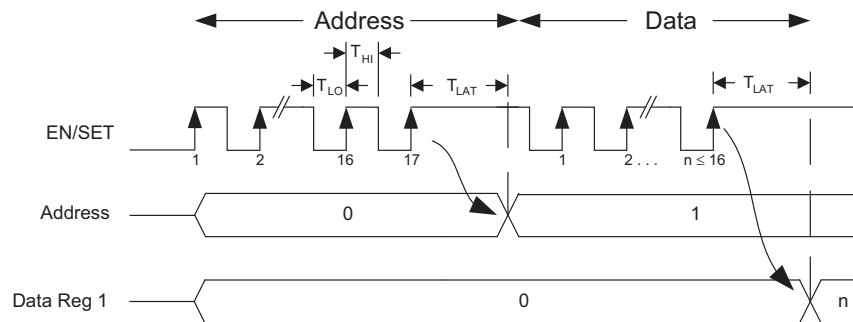

Figure 1: AS²Cwire™ Serial Interface Timing.

* Denotes the default value.

1.5A Step-Up Current Regulator for Flash LEDs

Flash/Safety Timer – Address 1

A timer function that enables the flash current sinks for a programmed amount of time is incorporated in the AAT1271. The on-time is programmed by loading the Timing Register at Address 1 with a value from 1 to 16 and by choosing a value for the external timing capacitor, C_T (see Table 3). When data is latched into Address 1, the data will be used at the next occurrence of an asserted FLEN, it will then revert back to the default value of Data 1, or 16/16. This feature eliminates the need for an external, housekeeping baseband controller to contain a safety delay routine. It also serves as a protection feature to minimize thermal issues with the Flash LEDs in the event an external controller's flash software routine experience hang-up or freeze. If no write instruction is applied to Address 1, then the safety timer will default to the maximum delay programmed externally at C_T .

The Flash Time T can be calculated by the following equation:

$$T = 7.98s/\mu F \cdot C_T (\mu F)$$

Where T is in seconds and C_T is in μF .

For example, using a 47nF capacitor at C_T sets the flash timeout to:

$$\text{Flash Timeout} = 7.98s/\mu F \cdot 47nF = 375ms$$

The relationship between the flash safety timeout and the capacitance of the timer capacitor is illustrated in Figure 2.

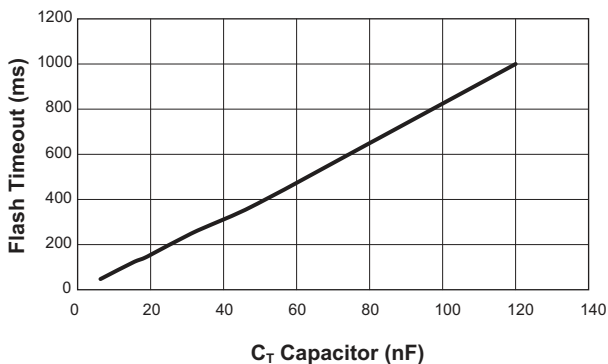

Figure 2: Flash Safety Timeout vs. Timer Capacitor.

Data	Ratio of MM Timeout
1*	16/16
2	15/16
3	14/16
4	13/16
5	12/16
6	11/16
7	10/16
8	9/16
9	8/16
10	7/16
11	6/16
12	5/16
13	4/16
14	3/16
15	2/16
16	1/16

Table 3: Address 1, Flash Safety Timer Programming; Maximum Value Programmed by C_T .

Output Enable Control – Address 2

In the case where two LEDs are used, each output can be enabled or disabled independently in movie mode as shown in Table 4. To enable or disable either or both FLOUTA and FLOUTB, a write instruction to Address 2 is applied to the AAT1271's EN/SET pin. If no write instruction is applied, the default value for Address 2 is FLOUTA, FLOUTB = OFF. During a flash event, both FLOUTA and FLOUTB will be enabled regardless of the movie-mode setting.

Data	Selection	
	FLOUTA	FLOUTB
1*	OFF	OFF
2	OFF**	ON
3	ON	OFF**
4	ON	ON

Table 4: Address 2, Movie Mode Output Configuration.

* Denotes the default value.

** A small current will flow due to the start-up test current.

1.5A Step-Up Current Regulator for Flash LEDs

Flash to Maximum Movie Mode Current Ratio – Address 3

The maximum movie-mode current is a fixed ratio of the flash current controlled by Address 3. The ratio may be varied from 1:2 to OFF in 16 linear steps as shown in Table 5. The default value for Address 3 is Data=4 and represents a flash to maximum movie mode current level of 1 to 7.3.

Data	FL to MM Ratio
1	1/2
2	1/3.8
3	1/5.5
4*	1/7.3
5	1/8.9
6	1/10.5
7	1/12.2
8	1/13.8
9	1/14.9
10	1/16.5
11	1/18
12	1/19.6
13	1/21.1
14	1/22.6
15	1/24
16	OFF

Table 5: Address 3, Flash/Movie Mode Current Ratio.

The default maximum movie mode current can be calculated:

$$I_{\text{MOVIE MODE[A/B]}} = \frac{I_{\text{FLOUTA/BIMAX}}}{7.3}$$

For example, if an R_{SET} value of 107k Ω is chosen, then the FLOUTA/FLOUTB flash current is set to 750mA. For movie mode operation, the maximum current available at either FLOUTA or FLOUTB is then:

$$I_{\text{MOVIE MODE[A/B]}} = \frac{I_{\text{FLOUTA/BIMAX}}}{7.3} = \frac{750\text{mA}}{7.3} = 103\text{mA}$$

The maximum movie mode current level can be calculated using the following equation:

$$I_{\text{MOVIE MODE[A/B]}} = \frac{81\text{k}\Omega \times A}{R_{\text{SET}}} = \frac{1}{\text{FL to MM Ratio}} = \text{Max Movie Mode Current}$$

Shutdown

Since the sink switches are the only power returns for all loads, there is no leakage current to load if all the sink switches are disabled. When EN/SET pin is held low for an amount of time greater than t_{OFF} (500 μs), the AAT1271 enters shutdown mode and draws less than 1 μA from V_{IN} . All data and address registers are cleared (reset to 0) during shutdown.

Selecting the Boost Inductor

The AAT1271 controller utilizes PWM control and the switching frequency is fixed. To maintain 2MHz maximum switching frequency and stable operation, a 1 μH inductor is recommended. Manufacturer's specifications list both the inductor DC current rating, which is a thermal limitation, and peak inductor current rating, which is determined by the saturation characteristics. Measurements at full load and high ambient temperature should be performed to ensure that the inductor does not saturate or exhibit excessive temperature rise.

Manufacturer	Part Number	Inductance (μH)	Saturated Rated Current (A)	DCR (m Ω)	Size (mm) LxWxH	Type
Cooper Bussmann	SD3812-1R0-R	1	2.69	48	4.0x4.0x1.2	Shielded Drum Core
Cooper Bussmann	SDH3812-1R0-R	1	3	45	3.8x3.8x1.2	Shielded Drum Core
Cooper Bussmann	SD10-1R0-R	1	2.25	44.8	5.2x5.2x1.0	Shielded Drum Core
Sumida	CDH38D11/S	1	2.8	48.8	4.0x4.0x1.2	Shielded Drum Core
Coilcraft	LPS4012-102NLC	1	2.5	60	4.1x4.1x1.2	Shielded Drum Core

Table 6: Typical Suggested Surface Mount Inductors.

*Denotes the default value.

1.5A Step-Up Current Regulator for Flash LEDs

The inductor (L) is selected to avoid saturation at minimum input voltage and maximum output load conditions. Worst-case peak current occurs at minimum input voltage (maximum duty cycle) and maximum load. Bench measurements are recommended to confirm actual I_{PEAK} and to ensure that the inductor does not saturate at maximum LED current and minimum input supply voltage. The RMS current flowing through the boost inductor is equal to the DC plus AC ripple components. Under worst case RMS conditions, the current waveform is critically continuous. The resulting RMS calculation yields worst case inductor loss. The RMS current value should be compared against the inductor manufacturer's temperature rise, or thermal derating guidelines:

$$I_{RMS} = \frac{I_{PEAK}}{\sqrt{3}}$$

For a given inductor type, smaller inductor size leads to an increase in DCR winding resistance and, in most cases, increased thermal impedance. Winding resistance degrades boost converter efficiency and increases the inductor's operating temperature:

$$P_{LOSS(INDUCTOR)} = I_{RMS}^2 \cdot DCR$$

Selecting the Boost Capacitors

In general, it is good design practice to place a decoupling capacitor (input capacitor) between the IN and GND pins. An input capacitor in the range of 2.2μF to 10μF is recommended. A larger input capacitor in this application may be required for stability, transient response, and/or ripple performance. The high output ripple inherent in the boost converter necessitates the use of low impedance output filtering. Multi-layer ceramic (MLC) capacitors provide small size and adequate capacitance, low parasitic equivalent series resistance (ESR) and equivalent series inductance (ESL), and are well suited for use with the AAT1271 boost regulator. MLC capacitors of type X7R or X5R are recommended to ensure good capacitance stability over the full operating temperature range. The output capacitor is selected to maintain the output load without significant voltage droop (ΔV_{OUT}) during the power switch ON interval. A 2.2μF ceramic output capacitor is recommended (see Table 7). Typically, 6.3V or 10V rated capacitors are required for this flash LED boost output. Ceramic capacitors selected as small as 0603 are available which meet these requirements. MLC capacitors exhibit significant capacitance reduction with applied voltage. Output ripple measurements should confirm that output voltage droop and operating stability are within acceptable limits. Voltage derating can minimize this factor, but results may vary with package size and among specific manufacturers. To maintain stable operation at full load, the output capacitor should be selected to maintain ΔV_{OUT} between 100mV and 200mV. The boost converter input current flows during both ON and OFF switching intervals. The input ripple current is less than the output ripple and, as a result, less input capacitance is required.

Manufacturer	Part Number	Capacitance (μF)	Voltage Rating (V)	Temp Co.	Case Size
Murata	GRM185R60J225KE26	2.2	6.3	X5R	0603
	GRM188R71A225KE15	2.2	10	X7R	0603
	GRM21BR70J225KA01	2.2	6.3	X7R	0805
	GRM21BR71A225KA01	2.2	10	X7R	0805
	GRM219R61A475KE19	4.7	10	X5R	0805
	GRM21BR71A106KE51	10	10	X7R	0805

Table 7: Typical Suggested Surface Mount Capacitors.

1.5A Step-Up Current Regulator for Flash LEDs

PCB Layout Guidelines

Boost converter performance can be adversely affected by poor layout. Possible impact includes high input and output voltage ripple, poor EMI performance, and reduced operating efficiency. Every attempt should be made to optimize the layout in order to minimize parasitic PCB effects (stray resistance, capacitance, and inductance) and EMI coupling from the high frequency SW node. A suggested PCB layout for the AAT1271 1.5A step-up regulator is shown in Figures 4 and 5. The following PCB layout guidelines should be considered:

1. Minimize the distance from capacitor C_{IN} and C_{OUT} 's negative terminals to the PGND pins. This is especially true with output capacitor C_{OUT} , which conducts high ripple current from the output to the PGND pins.

2. Minimize the distance under the inductor between IN and switching pin SW; minimize the size of the PCB area connected to the SW pin.
3. Maintain a ground plane and connect to the IC PGND pin(s) as well as the PGND connections of C_{IN} and C_{OUT} .
4. Consider additional PCB exposed area for the flash LEDs to maximize heatsinking capability. This may be necessary when using high current application and long flash duration application.
5. Connect the exposed paddle (bottom of the die) to either PGND or GND. Connect AGND, FLGND to GND as close as possible to the package.

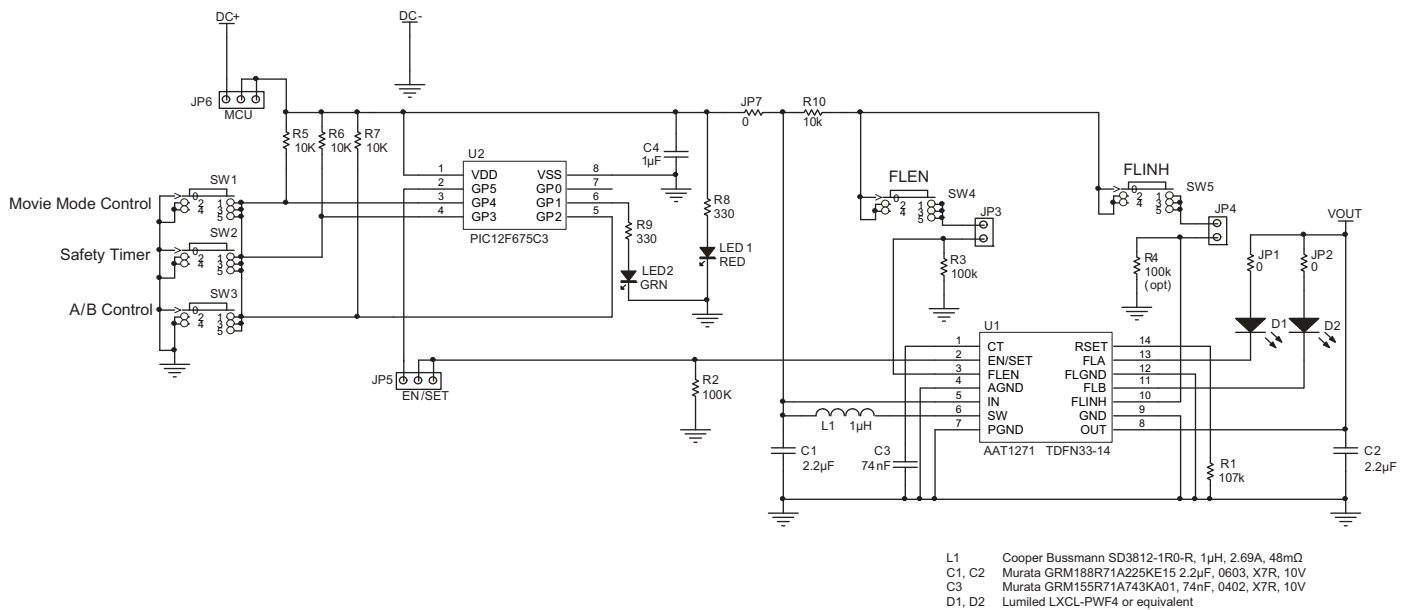

Figure 3: AAT1271 Evaluation Board Schematic.

DATA SHEET

AAT1271

1.5A Step-Up Current Regulator for Flash LEDs

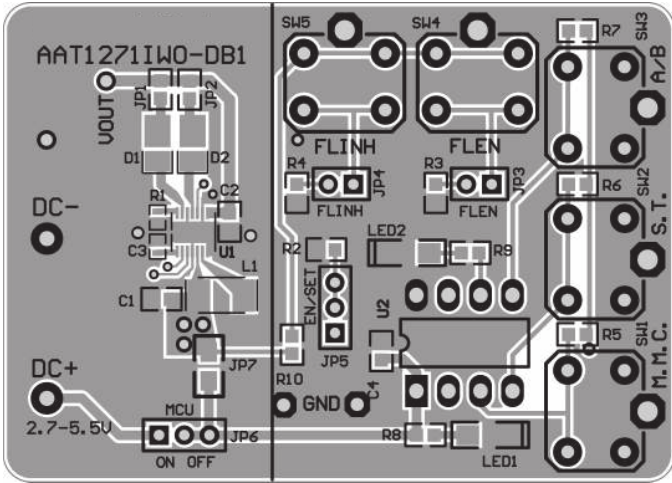

Figure 4: AAT1271 Evaluation Board Top Side Layout.

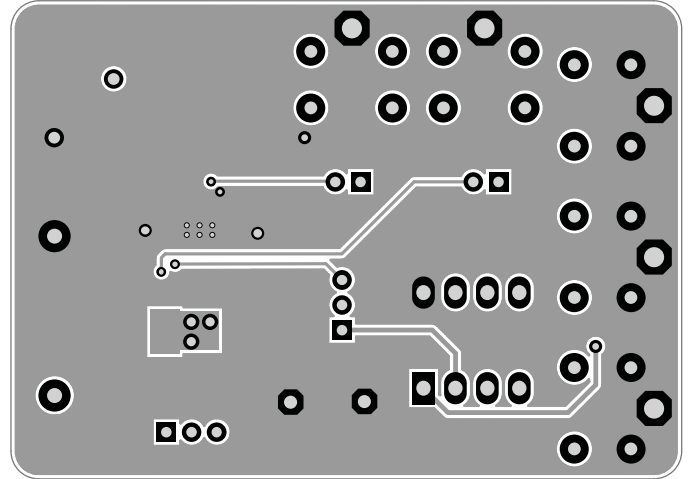

Figure 5: AAT1271 Evaluation Board Bottom Side Layout.

Component	Part Number	Description	Manufacturer
U1	AAT1271IWO	1.5A Step-Up Current Regulator for Flash LEDs; TDFN33-14 package	Skyworks
U2	PIC12F675	8-bit CMOS, FLASH-based μ C; 8-pin PDIP package	Microchip
SW1 – SW3	PTS645TL50	Switch, SPST, 5mm	ITT Industries
R1	Chip Resistor	107k Ω , 1%, 1/4W; 0402	Vishay
R2, R3, R4	Chip Resistor	100k Ω , 1%, 1/4W; 0603	Vishay
R5, R8	Chip Resistor	10k Ω , 5%, 1/4W; 0603	Vishay
R6, R7	Chip Resistor	330 Ω , 5%, 1/4W; 0603	Vishay
JP1, JP2, JP7	Chip Resistor	0 Ω , 5%	Vishay
C1, C2	GRM188R71A225KE15	2.2 μ F, 10V, X7R, 0603	Murata
C3	GRM155R71A743KA01	74nF, 10V, X7R, 0402	Murata
C4	GRM216R61A105KA01	1 μ F, 10V, X5R, 0805	Murata
L1	SD3812-1R0-R	Drum Core, 1 μ H, 2.69A, 48m Ω	Cooper Bussmann
D1-D2	LXCL-PWF4	White Flash LED	Lumileds, Philips
LED1	CMD15-21SRC/TR8	Red LED; 1206	Chicago Miniature Lamp
LED2	CMD15-21VGC/TR8	Green LED; 1206	Chicago Miniature Lamp
JP3, JP4, JP5, JP6	PRPN401PAEN	Conn. Header, 2mm zip	Sullins Electronics

Table 8: AAT1271 Evaluation Board Bill of Materials.

1.5A Step-Up Current Regulator for Flash LEDs

Ordering Information

Package	Marking ¹	Part Number (Tape and Reel) ²
TDFN33-14	ZUXYY	AAT1271IWO-T1



Skyworks Green™ products are compliant with all applicable legislation and are halogen-free. For additional information, refer to *Skyworks Definition of Green™*, document number SQ04-0074.

Package Information

TDFN33-14³

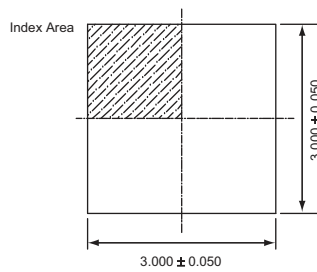

Top View

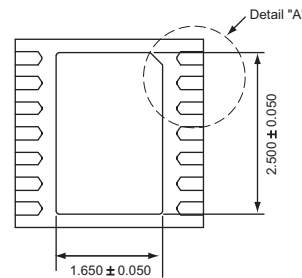

Bottom View

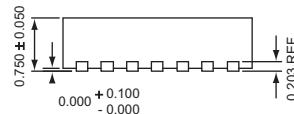

Side View

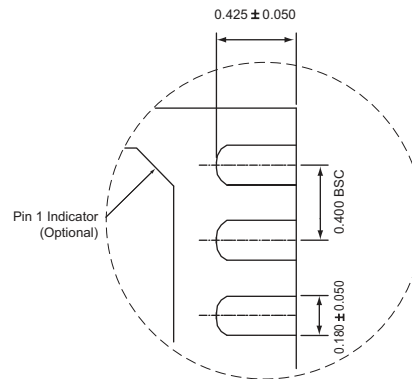

Detail "A"

All dimensions in millimeters.

1. XYY = assembly and date code.
2. Sample stock is generally held on part numbers listed in **BOLD**.
3. The leadless package family, which includes QFN, TQFN, DFN, TDFN, and STDFN, has exposed copper (unplated) at the end of the lead terminals due to the manufacturing process. A solder fillet at the exposed copper edge cannot be guaranteed and is not required to ensure a proper bottom solder connection.

1.5A Step-Up Current Regulator for Flash LEDs

Copyright © 2012 Skyworks Solutions, Inc. All Rights Reserved.

Information in this document is provided in connection with Skyworks Solutions, Inc. ("Skyworks") products or services. These materials, including the information contained herein, are provided by Skyworks as a service to its customers and may be used for informational purposes only by the customer. Skyworks assumes no responsibility for errors or omissions in these materials or the information contained herein. Skyworks may change its documentation, products, services, specifications or product descriptions at any time, without notice. Skyworks makes no commitment to update the materials or information and shall have no responsibility whatsoever for conflicts, incompatibilities, or other difficulties arising from any future changes.

No license, whether express, implied, by estoppel or otherwise, is granted to any intellectual property rights by this document. Skyworks assumes no liability for any materials, products or information provided hereunder, including the sale, distribution, reproduction or use of Skyworks products, information or materials, except as may be provided in Skyworks Terms and Conditions of Sale.

THE MATERIALS, PRODUCTS AND INFORMATION ARE PROVIDED "AS IS" WITHOUT WARRANTY OF ANY KIND, WHETHER EXPRESS, IMPLIED, STATUTORY, OR OTHERWISE, INCLUDING FITNESS FOR A PARTICULAR PURPOSE OR USE, MERCHANTABILITY, PERFORMANCE, QUALITY OR NON-INFRINGEMENT OF ANY INTELLECTUAL PROPERTY RIGHT; ALL SUCH WARRANTIES ARE HEREBY EXPRESSLY DISCLAIMED. SKYWORKS DOES NOT WARRANT THE ACCURACY OR COMPLETENESS OF THE INFORMATION, TEXT, GRAPHICS OR OTHER ITEMS CONTAINED WITHIN THESE MATERIALS. SKYWORKS SHALL NOT BE LIABLE FOR ANY DAMAGES, INCLUDING BUT NOT LIMITED TO ANY SPECIAL, INDIRECT, INCIDENTAL, STATUTORY, OR CONSEQUENTIAL DAMAGES, INCLUDING WITHOUT LIMITATION, LOST REVENUES OR LOST PROFITS THAT MAY RESULT FROM THE USE OF THE MATERIALS OR INFORMATION, WHETHER OR NOT THE RECIPIENT OF MATERIALS HAS BEEN ADVISED OF THE POSSIBILITY OF SUCH DAMAGE.

Skyworks products are not intended for use in medical, lifesaving or life-sustaining applications, or other equipment in which the failure of the Skyworks products could lead to personal injury, death, physical or environmental damage. Skyworks customers using or selling Skyworks products for use in such applications do so at their own risk and agree to fully indemnify Skyworks for any damages resulting from such improper use or sale.

Customers are responsible for their products and applications using Skyworks products, which may deviate from published specifications as a result of design defects, errors, or operation of products outside of published parameters or design specifications. Customers should include design and operating safeguards to minimize these and other risks. Skyworks assumes no liability for applications assistance, customer product design, or damage to any equipment resulting from the use of Skyworks products outside of stated published specifications or parameters.

Skyworks, the Skyworks symbol, and "Breakthrough Simplicity" are trademarks or registered trademarks of Skyworks Solutions, Inc., in the United States and other countries. Third-party brands and names are for identification purposes only, and are the property of their respective owners. Additional information, including relevant terms and conditions, posted at www.skyworksinc.com, are incorporated by reference.