

TPS7B83-Q1 150-mA, 40-V, Low-Dropout Regulator

1 Features

- AEC-Q100 qualified for automotive applications:
 - Temperature grade 1: -40°C to $+125^{\circ}\text{C}$, T_A
 - Junction temperature: -40°C to $+150^{\circ}\text{C}$, T_J
- Input voltage range: 3 V to 40 V (42 V max)
- Output voltage range: 3.3 V and 5 V (fixed)
- Output current: up to 150 mA
- Output voltage accuracy: $\pm 1\%$ (max)
- Low dropout voltage:
 - 230 mV (max) at 150 mA ($V_{OUT} \geq 3.3$ V)
- Low quiescent current:
 - 18 μA (typ)
- Excellent line transient response:
 - $\pm 2\%$ V_{OUT} deviation during cold-crank
 - $\pm 2\%$ V_{OUT} deviation ($1\text{-V}/\mu\text{s}$ V_{IN} slew rate)
- Stable with a 2.2- μF or larger capacitor
- **Functional Safety-Capable**
 - [Documentation available to aid functional safety system design](#)
- Package: 3-pin SOT-223

2 Applications

- [Reconfigurable instrument clusters](#)
- [Body control modules \(BCM\)](#)
- Always-on battery-connected applications:
 - [Automotive gateways](#)
 - [Remote keyless entries \(RKE\)](#)

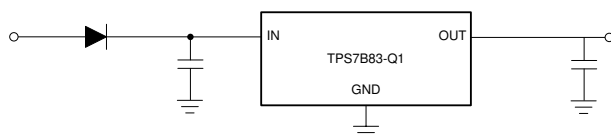

Typical Application Schematic

3 Description

The TPS7B83-Q1 is a low-dropout linear regulator designed to connect to the battery in automotive applications. The device has an input voltage range extending to 40 V, which allows the device to withstand transients (such as load dump) that are anticipated in automotive systems. With only an 18- μA quiescent current, the device is an optimal solution for powering always-on components such as microcontrollers (MCUs) and controller area network (CAN) transceivers in standby systems.

The device has state-of-the-art transient response that allows the output to quickly react to changes in load or line (for example, during cold-crank conditions). Additionally, the device has a novel architecture that minimizes output overshoot when recovering from dropout. During normal operation, the device has a tight DC accuracy of $\pm 1\%$ over line, load, and temperature.

Device Information⁽¹⁾

PART NUMBER	PACKAGE	BODY SIZE (NOM)
TPS7B83-Q1	SOT-223 (3)	6.50 mm × 3.50 mm

- (1) For all available packages, see the orderable addendum at the end of the data sheet.

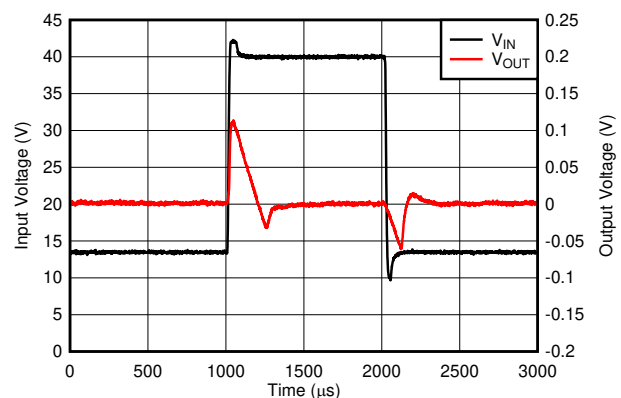

Line Transient Response
(3-V/ μs V_{IN} Slew Rate)



Table of Contents

1 Features	1	8 Application and Implementation	15
2 Applications	1	8.1 Application Information.....	15
3 Description	1	8.2 Typical Application.....	19
4 Revision History	2	9 Power Supply Recommendations	20
5 Pin Configuration and Functions	3	10 Layout	21
6 Specifications	3	10.1 Layout Guidelines.....	21
6.1 Absolute Maximum Ratings	3	10.2 Layout Example.....	21
6.2 ESD Ratings	3	11 Device and Documentation Support	22
6.3 Recommended Operating Conditions	4	11.1 Device Support.....	22
6.4 Thermal Information	4	11.2 Receiving Notification of Documentation Updates..	22
6.5 Electrical Characteristics	4	11.3 Support Resources.....	22
6.6 Typical Characteristics.....	6	11.4 Trademarks.....	22
7 Detailed Description	12	11.5 Electrostatic Discharge Caution.....	22
7.1 Overview.....	12	11.6 Glossary.....	22
7.2 Functional Block Diagram.....	12	12 Mechanical, Packaging, and Orderable	
7.3 Feature Description.....	13	Information	22
7.4 Device Functional Modes.....	14		

4 Revision History

NOTE: Page numbers for previous revisions may differ from page numbers in the current version.

DATE	REVISION	NOTES
November 2020	*	Initial release.

5 Pin Configuration and Functions

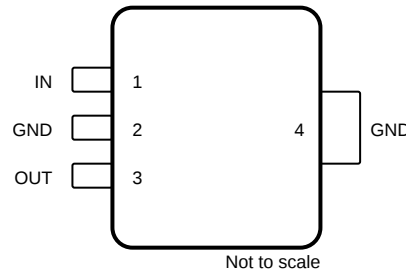

Figure 5-1. DCY Package, 3-Pin SOT-223, Top View

Table 5-1. Pin Functions

PIN		TYPE ⁽¹⁾	DESCRIPTION
NAME	DCY		
GND	2, 4	G	Ground pin. Connect this pin to the thermal pad with a low-impedance connection.
IN	1	P	Input power-supply voltage pin. For best transient response and to minimize input impedance, use the recommended value or larger ceramic capacitor from IN to ground, as listed in the <i>Recommended Operating Conditions</i> table and the Input Capacitor section. Place the input capacitor as close to the input of the device as possible.
OUT	3	O	Regulated output voltage pin. A capacitor is required from OUT to ground for stability. For best transient response, use the nominal recommended value or larger ceramic capacitor from OUT to ground; see the <i>Recommended Operating Conditions</i> table and the Output Capacitor section. Place the output capacitor as close to output of the device as possible. If using a high ESR capacitor, decouple the output with a 100-nF ceramic capacitor.

(1) I = input; O = output; P = power; G = ground.

6 Specifications

6.1 Absolute Maximum Ratings

over operating free-air temperature range (unless otherwise noted)⁽¹⁾

		MIN	MAX	UNIT
IN	Unregulated input	-0.3	42	V
OUT	Regulated output	-0.3	$V_{IN} + 0.3$ ⁽²⁾	V
T _A	Operating ambient temperature	-40	125	°C
T _J	Operating junction temperature	-40	150	°C
T _{stg}	Storage temperature	-65	150	°C

- (1) Stresses beyond those listed under *absolute maximum ratings* may cause permanent damage to the device. These are stress ratings only and functional operation of the device at these or any other conditions beyond those indicated under *recommended operating conditions* is not implied. Exposure to absolute-maximum-rated conditions for extended periods may affect device reliability.
- (2) The absolute maximum rating is $V_{IN} + 0.3$ V or 20 V, whichever is smaller.

6.2 ESD Ratings

			VALUE	UNIT	
V _(ESD)	Electrostatic discharge	Human-body model (HBM), per AEC Q100-002 ⁽¹⁾	±2000	V	
		Charged-device model (CDM), per AEC Q100-011	All pins		±500
			Corner pins		±750

(1) AEC Q100-002 indicates that HBM stressing shall be in accordance with the ANSI/ESDA/JEDEC JS-001 specification.

6.3 Recommended Operating Conditions

over operating free-air temperature range (unless otherwise noted)

		MIN	TYP	MAX	UNIT
V _{IN}	Input voltage	3		40	V
V _{OUT}	Output voltage	1.2		18	V
I _{OUT}	Output current	0		150	mA
C _{OUT}	Output capacitor ⁽²⁾	2.2		220	μF
ESR	Output capacitor ESR requirements ⁽³⁾	0.001		2	Ω
C _{IN}	Input capacitor ⁽¹⁾	0.1	1		μF
T _J	Operating junction temperature	-40		150	°C

(1) For robust EMI performance the minimum input capacitance is 500 nF.

(2) Effective output capacitance of 1 μF minimum required for stability.

(3) If using a large ESR capacitor it is recommended to decouple this with a 100-nF ceramic capacitor to improve transient performance.

6.4 Thermal Information

THERMAL METRIC ^{(1) (2)}		TPS7B83-Q1	UNIT
		DCY	
		3 PINS	
R _{θJA}	Junction-to-ambient thermal resistance ⁽³⁾	77.1	°C/W
R _{θJC(top)}	Junction-to-case (top) thermal resistance	41.7	°C/W
R _{θJB}	Junction-to-board thermal resistance	11.7	°C/W
ψ _{JT}	Junction-to-top characterization parameter	3.3	°C/W
ψ _{JB}	Junction-to-board characterization parameter	11.5	°C/W
R _{θJC(bot)}	Junction-to-case (bottom) thermal resistance	11.5	°C/W

(1) The thermal data is based on the JEDEC standard high K profile, JESD 51-7. Two-signal, two-plane, four-layer board with 2-oz. copper. The copper pad is soldered to the thermal land pattern. Also, correct attachment procedure must be incorporated.

(2) For more information about traditional and new thermal metrics, see the [Semiconductor and IC Package Thermal Metrics](#) application report.

(3) The 1s0p R_{θJA} is 154.6°C/W for the DCY package.

6.5 Electrical Characteristics

specified at T_J = -40°C to +150°C, V_{IN} = 13.5 V, I_{OUT} = 0 mA, C_{OUT} = 2.2 μF, 1 mΩ < C_{OUT} ESR < 2 Ω, C_{IN} = 1 μF typical values are at T_J = 25°C

PARAMETER		TEST CONDITIONS		MIN	TYP	MAX	UNIT
V _{OUT}	Regulated output accuracy DCY	V _{IN} = V _{OUT} + 500 mV to 40 V, I _{OUT} = 100 μA to 150 mA ⁽¹⁾	T _J = 25°C	-0.75		0.75	%
			T _J = -40°C to +150°C	-1		1	
ΔV _{OUT(ΔVIN)}	Line regulation	Change in percent of output voltage	V _{IN} = V _{OUT} + 500 mV to 40 V, I _{OUT} = 100 μA			0.2	%
ΔV _{OUT(ΔIOUT)}	Load regulation	Change in percent of output voltage	V _{IN} = V _{OUT} + 500 mV, I _{OUT} = 100 μA to 150 mA			0.2	
ΔV _{OUT}	Load transient response settling time ^{(2) (3)}	C _{OUT} = 10 μF	C _{OUT} = 10 μF			100	μs
	Load transient response overshoot, undershoot ⁽³⁾		I _{OUT} = 45 mA to 105 mA	-2%		10%	%V _{OUT}
			I _{OUT} = 0 mA to 150 mA	-10%			

6.5 Electrical Characteristics (continued)

specified at $T_J = -40^\circ\text{C}$ to $+150^\circ\text{C}$, $V_{IN} = 13.5\text{ V}$, $I_{OUT} = 0\text{ mA}$, $C_{OUT} = 2.2\text{ }\mu\text{F}$, $1\text{ m}\Omega < C_{OUT}\text{ ESR} < 2\text{ }\Omega$, $C_{IN} = 1\text{ }\mu\text{F}$ typical values are at $T_J = 25^\circ\text{C}$

PARAMETER		TEST CONDITIONS		MIN	TYP	MAX	UNIT
I_Q	Quiescent current	$V_{IN} = V_{OUT} + 500\text{ mV}$ to 40 V , $I_{OUT} = 0\text{ mA}$	$T_J = 25^\circ\text{C}$	18	21		μA
			$T_J = -40^\circ\text{C}$ to $+150^\circ\text{C}$			26	
		$I_{OUT} = 500\text{ }\mu\text{A}$	$T_J = -40^\circ\text{C}$ to $+150^\circ\text{C}$			35	
V_{DO}	Dropout voltage	$I_{OUT} \leq 1\text{ mA}$, $V_{OUT} \geq 3.3\text{ V}$, $V_{IN} = V_{OUT(NOM)} \times 0.95$				47	mV
		$I_{OUT} = 105\text{ mA}$, $V_{OUT} \geq 3.3\text{ V}$, $V_{IN} = V_{OUT(NOM)}$		130	180		
		$I_{OUT} = 150\text{ mA}$, $V_{OUT} \geq 3.3\text{ V}$, $V_{IN} = V_{OUT(NOM)}$		160	230		
$V_{UVLO(RISING)}$	Rising input supply UVLO	V_{IN} rising		2.6	2.7	2.82	V
$V_{UVLO(FALLING)}$	Falling input supply UVLO	V_{IN} falling		2.38	2.5	2.6	V
$V_{UVLO(HYST)}$	V_{UVLO} hysteresis				230		mV
I_{CL}	Output current limit	$V_{IN} = V_{OUT(nom)} + 1\text{ V}$, V_{OUT} short to $90\% \times V_{OUT(NOM)}$		180	220	260	mA
PSRR	Power-supply ripple rejection	$V_{IN} - V_{OUT} = 500\text{ mV}$, frequency = 1 kHz , $I_{OUT} = 150\text{ mA}$			55		dB
V_n	Output noise voltage	$V_{OUT} = 3.3\text{ V}$, BW = 10 Hz to 100 kHz			280		μV_{RMS}
$T_{SD(SHUTDOWN)}$	Junction shutdown temperature				175		$^\circ\text{C}$
$T_{SD(HYST)}$	Hysteresis of thermal shutdown				20		$^\circ\text{C}$

- (1) Power dissipation is limited to 2W for IC production testing purposes. The power dissipation can be higher during normal operation. Please see the thermal dissipation section for more information on how much power the device can dissipate while maintaining a junction temperature below 150°C .
- (2) The settling time is measured from when I_{OUT} is stepped from 45mA to 105 mA to when the output voltage recovers to $V_{OUT} = V_{OUT(nom)} - 5\text{ mV}$.
- (3) This specification is specified by design.

6.6 Typical Characteristics

specified at $T_J = -40^\circ\text{C}$ to $+150^\circ\text{C}$, $V_{IN} = 13.5\text{ V}$, $I_{OUT} = 100\ \mu\text{A}$, $C_{OUT} = 2.2\ \mu\text{F}$, $1\ \text{m}\Omega < C_{OUT}\ \text{ESR} < 2\ \Omega$, and $C_{IN} = 1\ \mu\text{F}$ (unless otherwise noted)

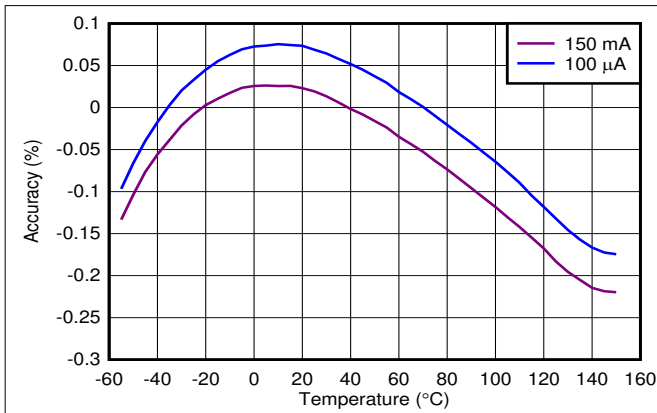
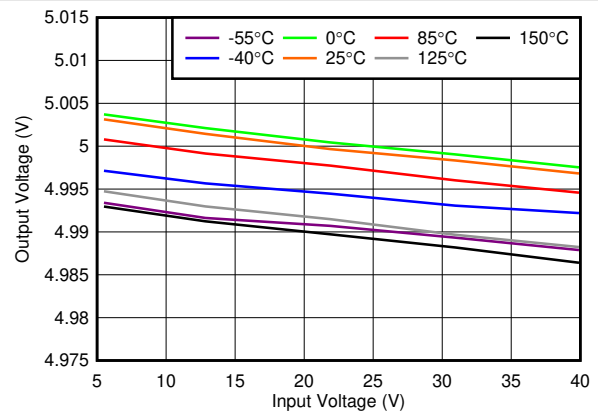
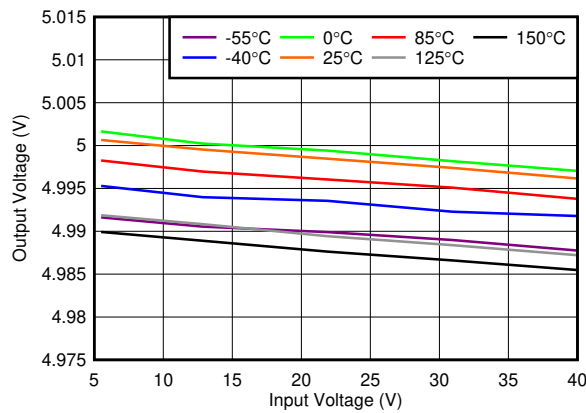

Figure 6-1. Accuracy vs Temperature



$V_{OUT} = 5\text{ V}$, $I_{OUT} = 150\text{ mA}$

Figure 6-2. Line Regulation vs V_{IN}



$V_{OUT} = 5\text{ V}$, $I_{OUT} = 5\text{ mA}$

Figure 6-3. Line Regulation vs V_{IN}

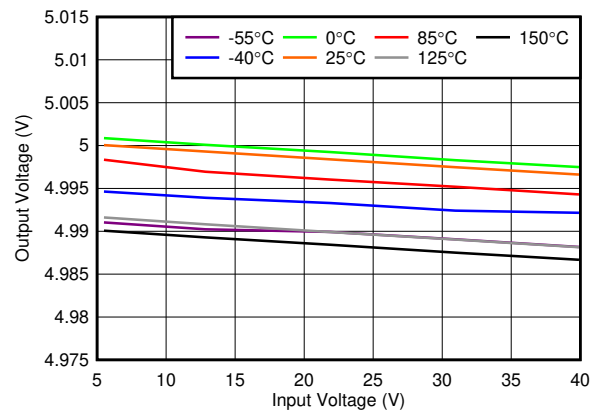

$V_{OUT} = 5\text{ V}$, $I_{OUT} = 1\text{ mA}$

Figure 6-4. Line Regulation vs V_{IN}

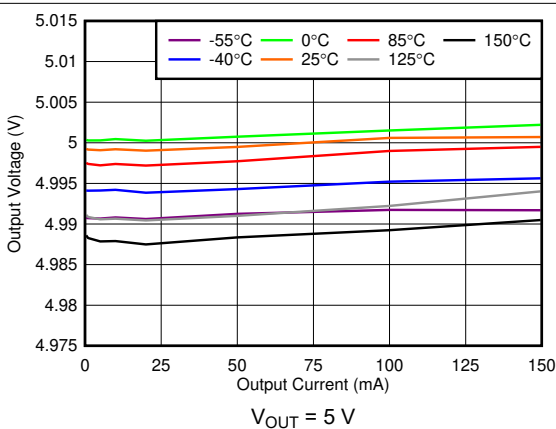

$V_{OUT} = 5\text{ V}$

Figure 6-5. Load Regulation vs I_{OUT}

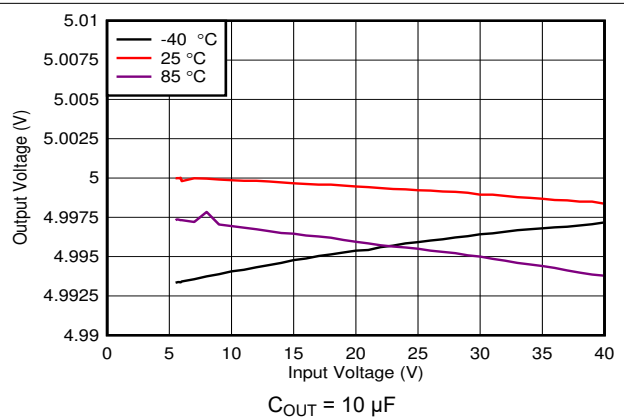

$C_{OUT} = 10\ \mu\text{F}$

Figure 6-6. Line Regulation at 50 mA

6.6 Typical Characteristics (continued)

specified at $T_J = -40^\circ\text{C}$ to $+150^\circ\text{C}$, $V_{IN} = 13.5\text{ V}$, $I_{OUT} = 100\ \mu\text{A}$, $C_{OUT} = 2.2\ \mu\text{F}$, $1\ \text{m}\Omega < C_{OUT}\ \text{ESR} < 2\ \Omega$, and $C_{IN} = 1\ \mu\text{F}$ (unless otherwise noted)

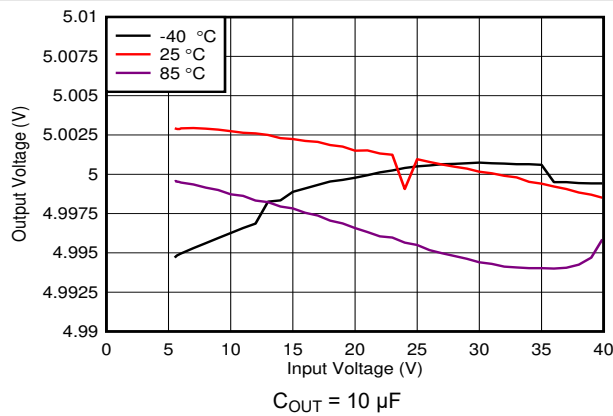

Figure 6-7. Line Regulation at 100 mA

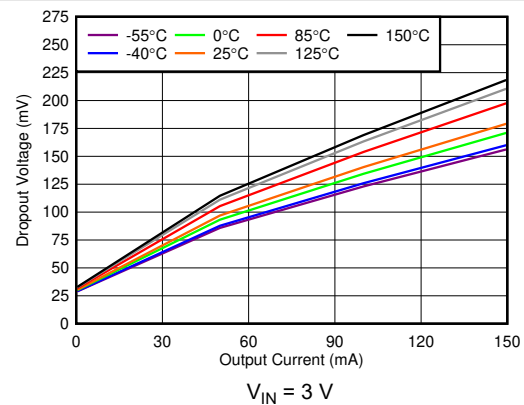

Figure 6-8. Dropout Voltage (V_{DO}) vs I_{OUT}

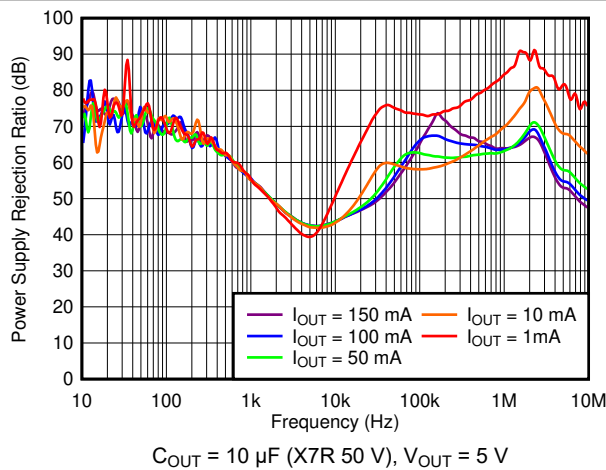

Figure 6-9. PSRR vs Frequency and I_{OUT}

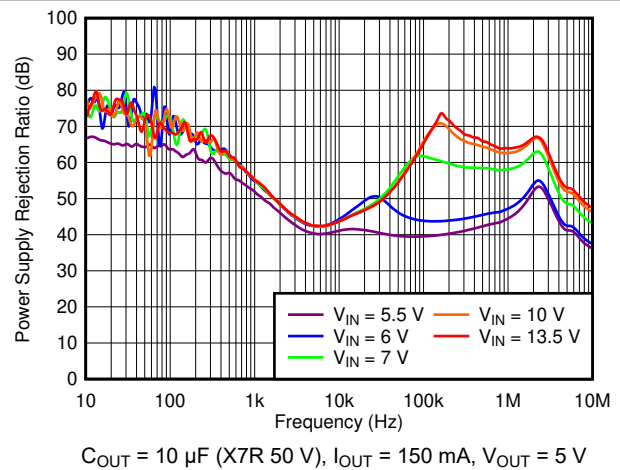

Figure 6-10. PSRR vs Frequency and V_{IN}

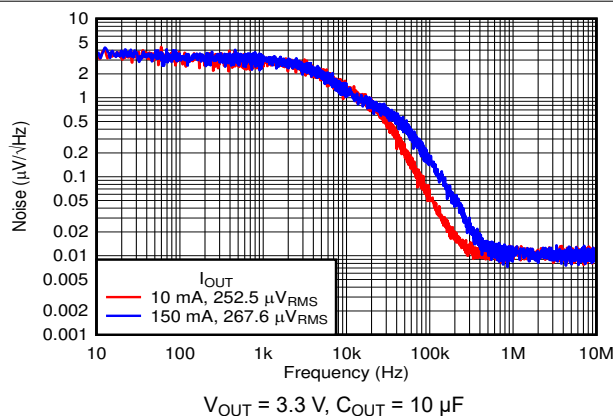

Figure 6-11. Noise vs Frequency at 3.3 V

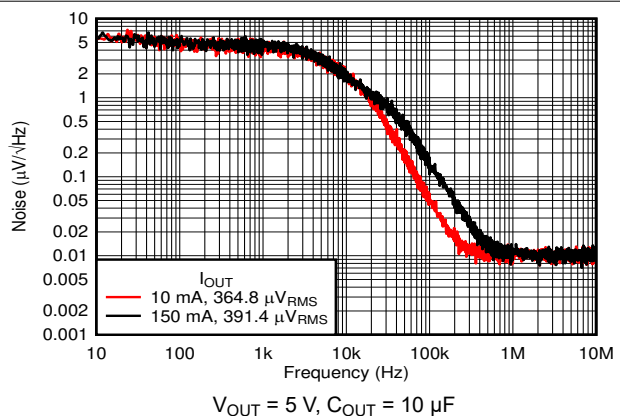
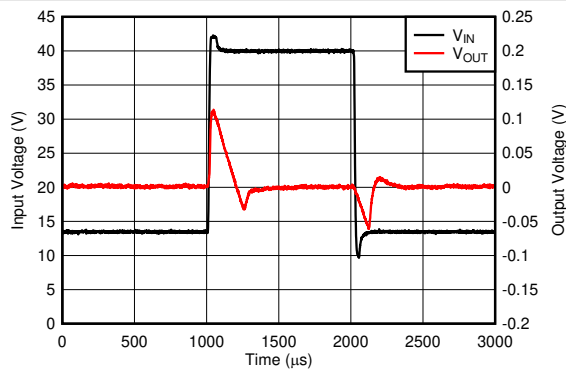

Figure 6-12. Noise vs Frequency at 5.0 V

6.6 Typical Characteristics (continued)

specified at $T_J = -40^\circ\text{C}$ to $+150^\circ\text{C}$, $V_{IN} = 13.5\text{ V}$, $I_{OUT} = 100\ \mu\text{A}$, $C_{OUT} = 2.2\ \mu\text{F}$, $1\ \text{m}\Omega < C_{OUT}\ \text{ESR} < 2\ \Omega$, and $C_{IN} = 1\ \mu\text{F}$ (unless otherwise noted)



$V_{OUT} = 5\text{ V}$, $I_{OUT} = 1\text{ mA}$, $V_{IN} = 13.5\text{ V}$ to 40 V ,
slew rate = $2.7\text{ V}/\mu\text{s}$, $V_{EN} = 3.3\text{ V}$, $C_{OUT} = 10\ \mu\text{F}$

Figure 6-13. Line Transients at 13.5 V to 40 V

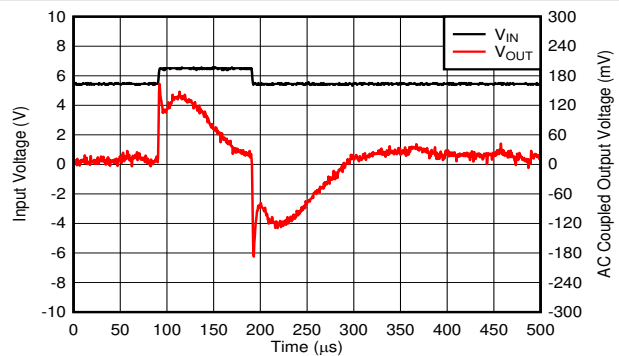

$V_{OUT} = 5\text{ V}$, $V_{IN} = 5.5\text{ V}$ to 6.5 V , $t_{\text{rise}} = 1\ \mu\text{s}$, $C_{OUT} = 10\ \mu\text{F}$

Figure 6-14. Line Transients at 5.5 V to 6.5 V

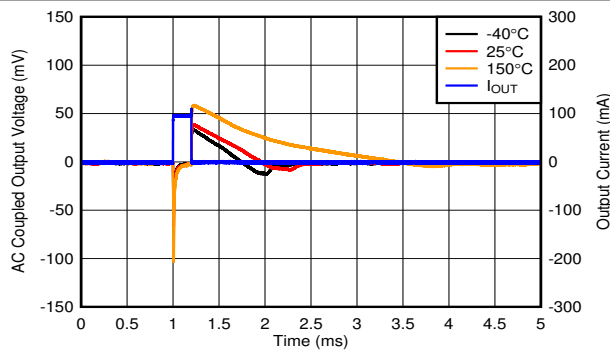

$V_{OUT} = 5\text{ V}$, $I_{OUT} = 0\text{ mA}$ to 100 mA , slew rate = $1\text{ A}/\mu\text{s}$,
 $V_{EN} = 3.3\text{ V}$, $C_{OUT} = 10\ \mu\text{F}$

Figure 6-15. Load Transient, No Load to 100 mA

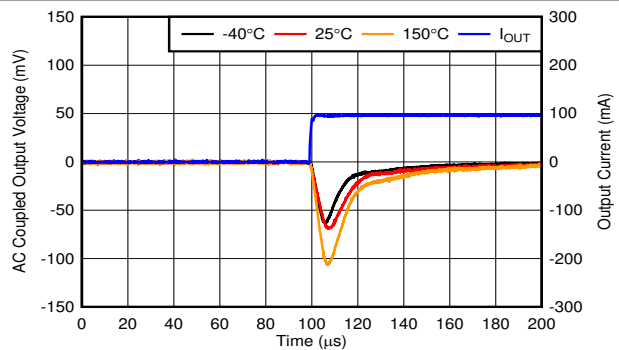

$V_{OUT} = 5\text{ V}$, $I_{OUT} = 0\text{ mA}$ to 100 mA , slew rate = $1\text{ A}/\mu\text{s}$,
 $V_{EN} = 3.3\text{ V}$, $C_{OUT} = 10\ \mu\text{F}$

Figure 6-16. Load Transient, No Load to 100-mA Rising Edge

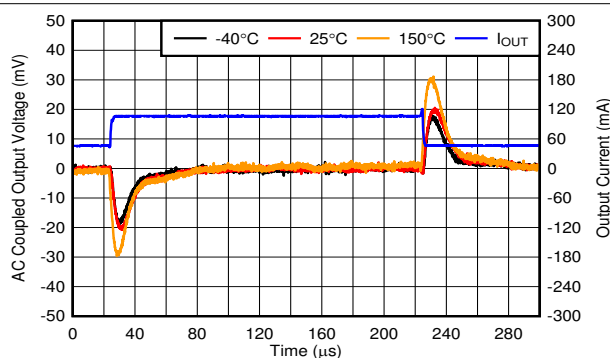

$V_{OUT} = 5\text{ V}$, $I_{OUT} = 45\text{ mA}$ to 105 mA , slew rate = $0.1\text{ A}/\mu\text{s}$,
 $V_{EN} = 3.3\text{ V}$, $C_{OUT} = 10\ \mu\text{F}$

Figure 6-17. Load Transient, 45 mA to 105 mA

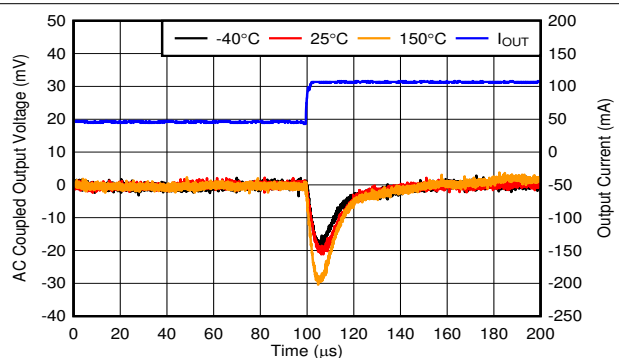

$V_{OUT} = 5\text{ V}$, $I_{OUT} = 45\text{ mA}$ to 105 mA , slew rate = $0.1\text{ A}/\mu\text{s}$,
 $V_{EN} = 3.3\text{ V}$, $C_{OUT} = 10\ \mu\text{F}$

Figure 6-18. Load Transient, 45-mA to 105-mA Rising Edge

6.6 Typical Characteristics (continued)

specified at $T_J = -40^\circ\text{C}$ to $+150^\circ\text{C}$, $V_{IN} = 13.5\text{ V}$, $I_{OUT} = 100\ \mu\text{A}$, $C_{OUT} = 2.2\ \mu\text{F}$, $1\ \text{m}\Omega < C_{OUT}\ \text{ESR} < 2\ \Omega$, and $C_{IN} = 1\ \mu\text{F}$ (unless otherwise noted)

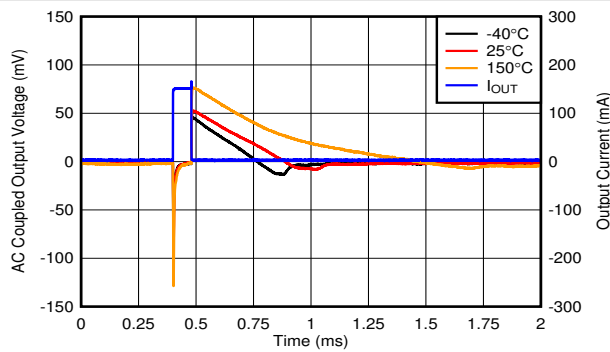

$V_{OUT} = 5\text{ V}$, $I_{OUT} = 0\text{ mA}$ to 150 mA , slew rate = $1\ \text{A}/\mu\text{s}$,
 $V_{EN} = 3.3\text{ V}$, $C_{OUT} = 10\ \mu\text{F}$

Figure 6-19. Load Transient, No Load to 150 mA

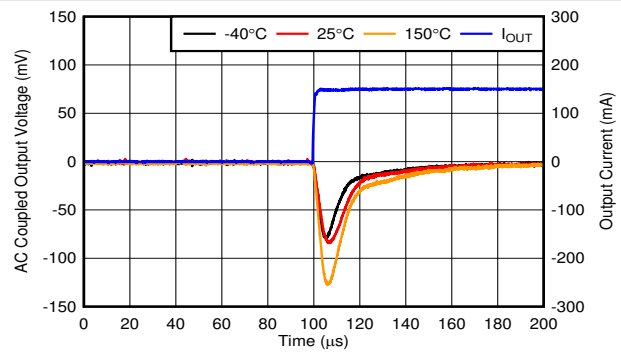

$V_{OUT} = 5\text{ V}$, $I_{OUT} = 0\text{ mA}$ to 150 mA , slew rate = $1\ \text{A}/\mu\text{s}$, $V_{EN} = 3.3\text{ V}$, $C_{OUT} = 10\ \mu\text{F}$

Figure 6-20. Load Transient, No Load to 150-mA Rising Edge

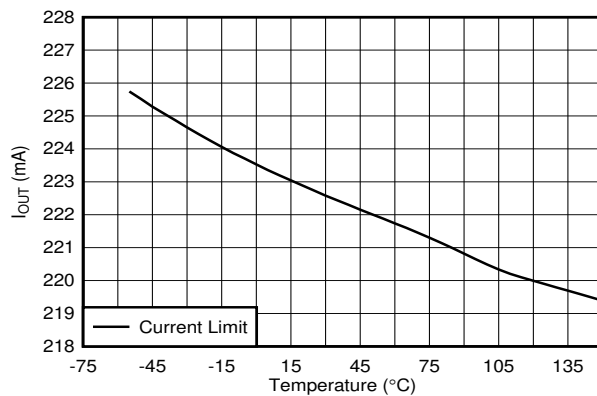

$V_{IN} = V_{OUT} + 1\text{ V}$, $V_{OUT} = 90\% \times V_{OUT(NOM)}$

Figure 6-21. Output Current Limit vs Temperature

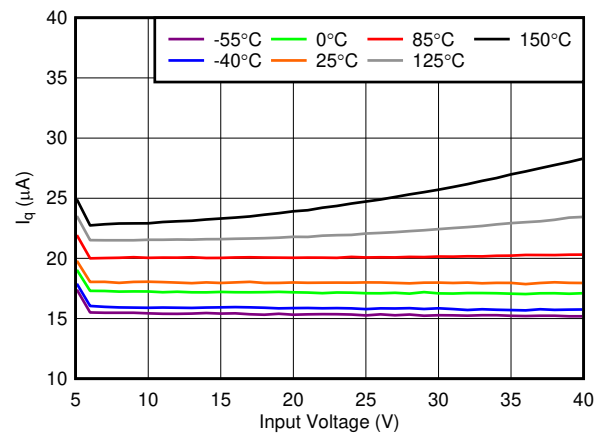

$V_{OUT} = 5\text{ V}$

Figure 6-22. Quiescent Current (I_Q) vs V_{IN}

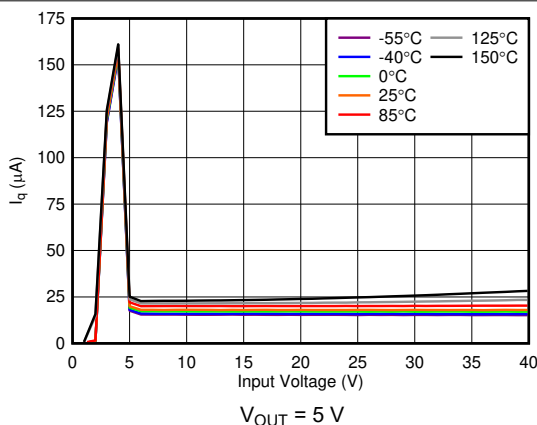

$V_{OUT} = 5\text{ V}$

Figure 6-23. Quiescent Current (I_Q) vs V_{IN}

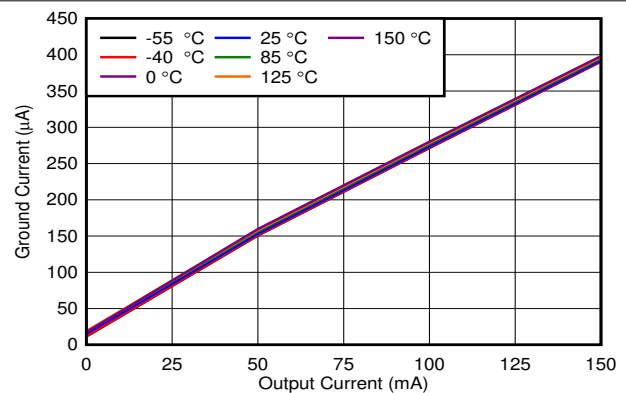

Figure 6-24. Ground Current (I_{GND}) vs I_{OUT}

6.6 Typical Characteristics (continued)

specified at $T_J = -40^\circ\text{C}$ to $+150^\circ\text{C}$, $V_{IN} = 13.5\text{ V}$, $I_{OUT} = 100\ \mu\text{A}$, $C_{OUT} = 2.2\ \mu\text{F}$, $1\ \text{m}\Omega < C_{OUT}\ \text{ESR} < 2\ \Omega$, and $C_{IN} = 1\ \mu\text{F}$ (unless otherwise noted)

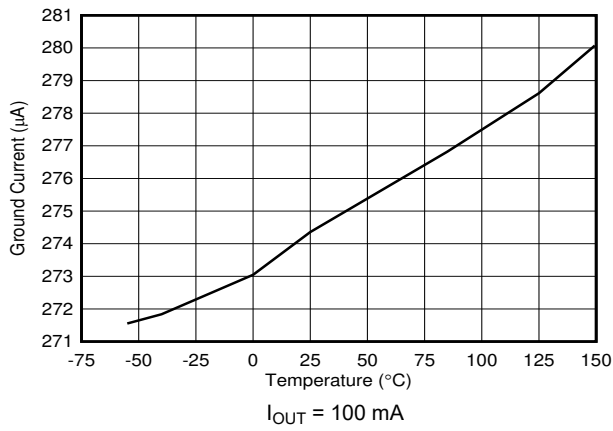

Figure 6-25. Ground Current

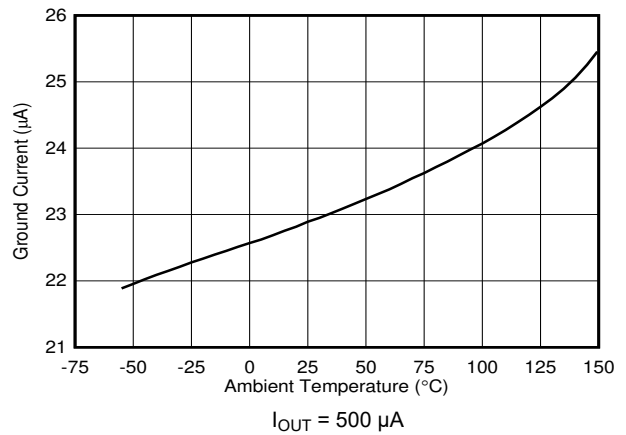

Figure 6-26. Ground Current

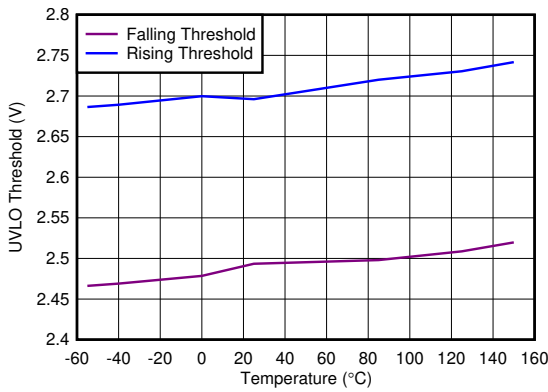

Figure 6-27. Undervoltage Lockout (UVLO) Threshold vs Temperature

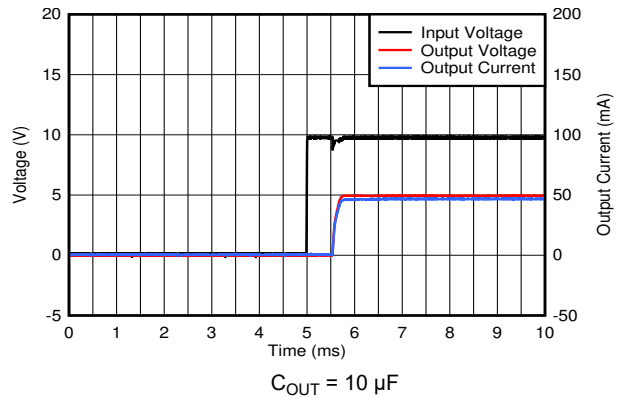

Figure 6-28. Startup Plot

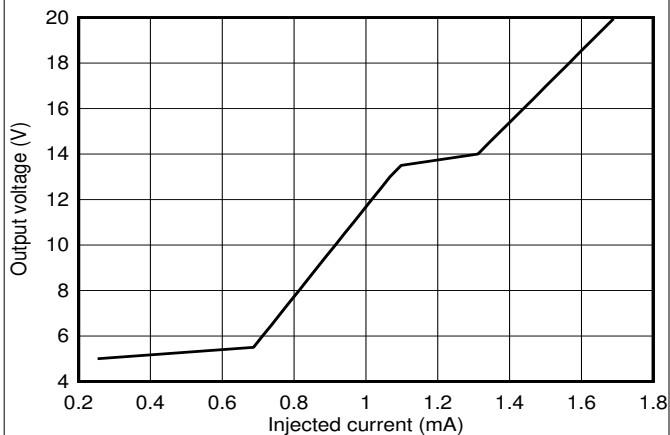

Figure 6-29. Output Voltage vs Injected Current

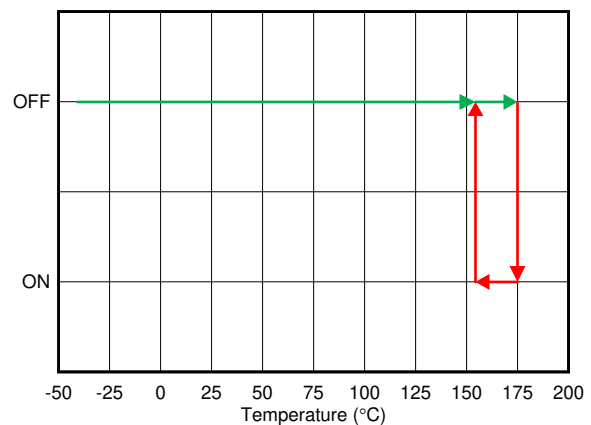

Figure 6-30. Thermal Shutdown

6.6 Typical Characteristics (continued)

specified at $T_J = -40^{\circ}\text{C}$ to $+150^{\circ}\text{C}$, $V_{IN} = 13.5\text{ V}$, $I_{OUT} = 100\ \mu\text{A}$, $C_{OUT} = 2.2\ \mu\text{F}$, $1\ \text{m}\Omega < C_{OUT}\ \text{ESR} < 2\ \Omega$, and $C_{IN} = 1\ \mu\text{F}$ (unless otherwise noted)

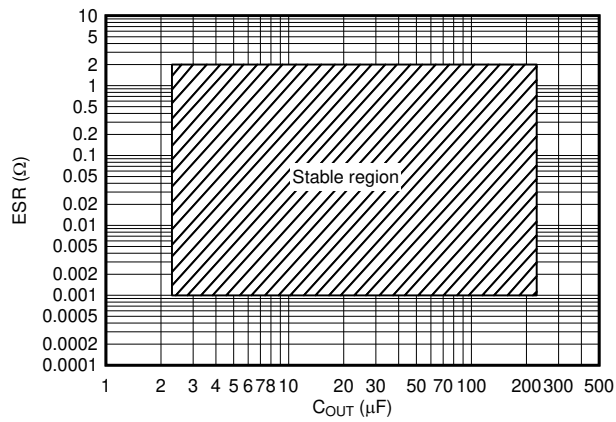

Figure 6-31. Stability ESR vs C_{OUT}

7 Detailed Description

7.1 Overview

The TPS7B83-Q1 is a low-dropout linear regulator (LDO) designed to connect to the battery in automotive applications. The device has an input voltage range extending to 40 V, which allows the device to withstand transients (such as load dumps) that are anticipated in automotive systems. With only a 18- μ A quiescent current at light loads, the device is an optimal solution for powering always-on components.

The device has a state-of-the-art transient response that allows the output to quickly react to changes in the load or line (for example, during cold-crank conditions). Additionally, the device has a novel architecture that minimizes output overshoot when recovering from dropout. During normal operation, the device has a tight DC accuracy of $\pm 1\%$ over line, load, and temperature.

7.2 Functional Block Diagram

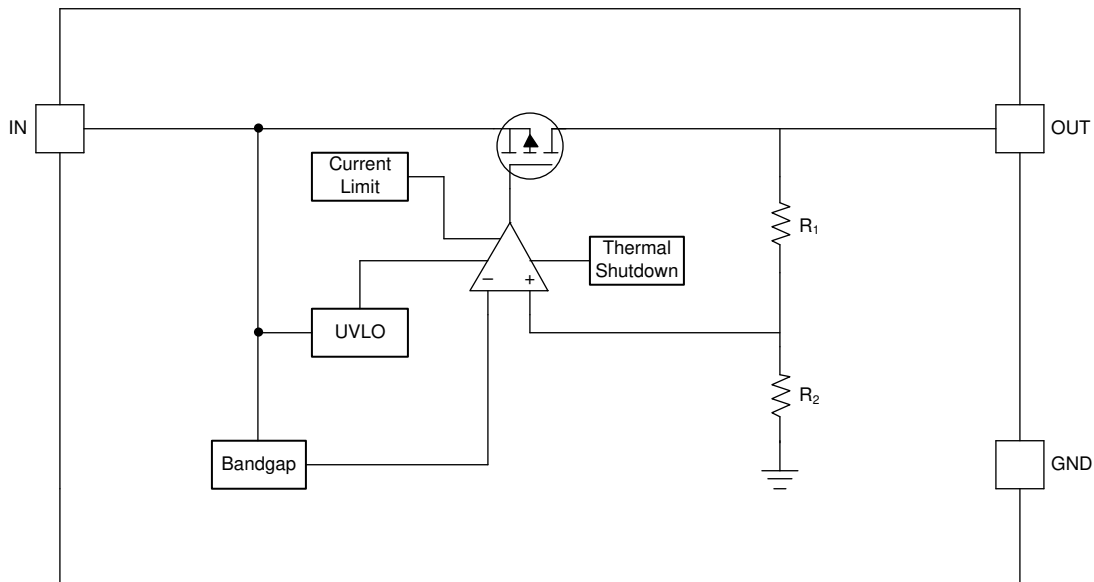

7.3 Feature Description

7.3.1 Undervoltage Lockout

The device has an independent undervoltage lockout (UVLO) circuit that monitors the input voltage, allowing a controlled and consistent turn on and off of the output voltage. To prevent the device from turning off if the input drops during turn on, the UVLO has hysteresis as specified in the *Electrical Characteristics* table.

7.3.2 Thermal Shutdown

The device contains a thermal shutdown protection circuit to disable the device when the junction temperature (T_J) of the pass transistor rises to $T_{SD(\text{shutdown})}$ (typical). Thermal shutdown hysteresis assures that the device resets (turns on) when the temperature falls to $T_{SD(\text{reset})}$ (typical).

The thermal time-constant of the semiconductor die is fairly short, thus the device may cycle on and off when thermal shutdown is reached until power dissipation is reduced. Power dissipation during startup can be high from large $V_{IN} - V_{OUT}$ voltage drops across the device or from high inrush currents charging large output capacitors. Under some conditions, the thermal shutdown protection disables the device before startup completes.

For reliable operation, limit the junction temperature to the maximum listed in the *Recommended Operating Conditions* table. Operation above this maximum temperature causes the device to exceed its operational specifications. Although the internal protection circuitry of the device is designed to protect against thermal overall conditions, this circuitry is not intended to replace proper heat sinking. Continuously running the device into thermal shutdown or above the maximum recommended junction temperature reduces long-term reliability.

7.3.3 Current Limit

The device has an internal current limit circuit that protects the regulator during transient high-load current faults or shorting events. The current limit is a brickwall scheme. In a high-load current fault, the brickwall scheme limits the output current to the current limit (I_{CL}). I_{CL} is listed in the *Electrical Characteristics* table.

The output voltage is not regulated when the device is in current limit. When a current limit event occurs, the device begins to heat up because of the increase in power dissipation. When the device is in brickwall current limit, the pass transistor dissipates power $[(V_{IN} - V_{OUT}) \times I_{CL}]$. If thermal shutdown is triggered, the device turns off. After the device cools down, the internal thermal shutdown circuit turns the device back on. If the output current fault condition continues, the device cycles between current limit and thermal shutdown. For more information on current limits, see the [Know Your Limits application report](#).

Figure 7-1 shows a diagram of the current limit.

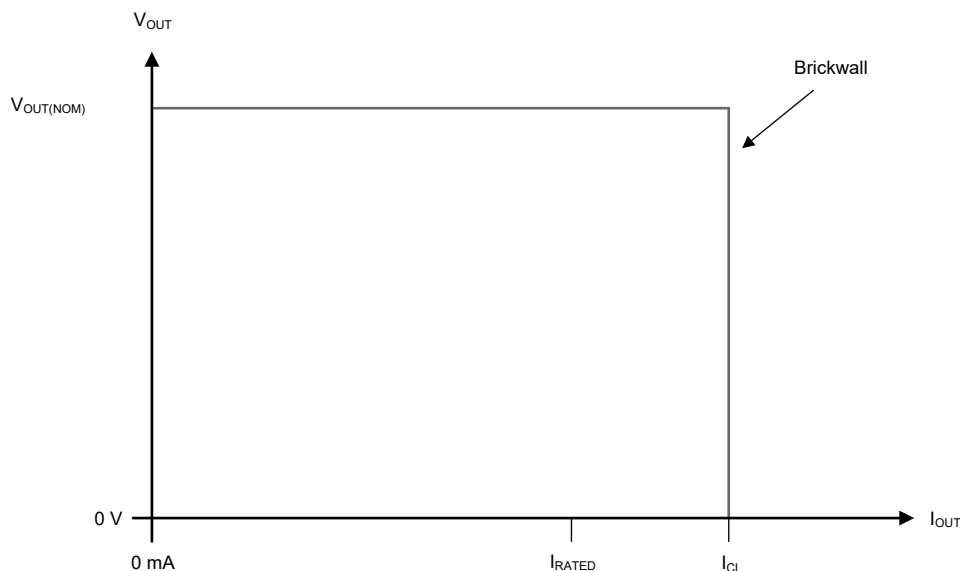

Figure 7-1. Current Limit

7.4 Device Functional Modes

7.4.1 Device Functional Mode Comparison

The *Device Functional Mode Comparison* table shows the conditions that lead to the different modes of operation. See the *Electrical Characteristics* table for parameter values.

Table 7-1. Device Functional Mode Comparison

OPERATING MODE	PARAMETER		
	V_{IN}	I_{OUT}	T_J
Normal operation	$V_{IN} > V_{OUT(nom)} + V_{DO}$ and $V_{IN} > V_{IN(min)}$	$I_{OUT} < I_{OUT(max)}$	$T_J < T_{SD(shutdown)}$
Dropout operation	$V_{IN(min)} < V_{IN} < V_{OUT(nom)} + V_{DO}$	$I_{OUT} < I_{OUT(max)}$	$T_J < T_{SD(shutdown)}$
Disabled (any true condition disables the device)	$V_{IN} < V_{UVLO}$	Not applicable	$T_J > T_{SD(shutdown)}$

7.4.2 Normal Operation

The device regulates to the nominal output voltage when the following conditions are met:

- The input voltage is greater than the nominal output voltage plus the dropout voltage ($V_{OUT(nom)} + V_{DO}$)
- The output current is less than the current limit ($I_{OUT} < I_{CL}$)
- The device junction temperature is less than the thermal shutdown temperature ($T_J < T_{SD}$)
- The enable voltage has previously exceeded the enable rising threshold voltage and has not yet decreased to less than the enable falling threshold

7.4.3 Dropout Operation

If the input voltage is lower than the nominal output voltage plus the specified dropout voltage, but all other conditions are met for normal operation, the device operates in dropout mode. In this mode, the output voltage tracks the input voltage. During this mode, the transient performance of the device becomes significantly degraded because the pass transistor is in the ohmic or triode region, and acts as a switch. Line or load transients in dropout can result in large output-voltage deviations.

When the device is in a steady dropout state (defined as when the device is in dropout, $V_{IN} < V_{OUT(NOM)} + V_{DO}$, directly after being in a normal regulation state, but *not* during startup), the pass transistor is driven into the ohmic or triode region. When the input voltage returns to a value greater than or equal to the nominal output voltage plus the dropout voltage ($V_{OUT(NOM)} + V_{DO}$), the output voltage can overshoot for a short period of time while the device pulls the pass transistor back into the linear region.

8 Application and Implementation

Note

Information in the following applications sections is not part of the TI component specification, and TI does not warrant its accuracy or completeness. TI's customers are responsible for determining suitability of components for their purposes, as well as validating and testing their design implementation to confirm system functionality.

8.1 Application Information

8.1.1 Input and Output Capacitor Selection

The TPS7B83-Q1 requires an output capacitor of 2.2 μF or larger (1 μF or larger capacitance) for stability and an equivalent series resistance (ESR) between 0.001 Ω and 2 Ω . For the best transient performance, use X5R- and X7R-type ceramic capacitors because these capacitors have minimal variation in value and ESR over temperature. When choosing a capacitor for a specific application, be mindful of the DC bias characteristics for the capacitor. Higher output voltages cause a significant derating of the capacitor. For best performance, the maximum recommended output capacitance is 220 μF .

Although an input capacitor is not required for stability, good analog design practice is to connect a capacitor from IN to GND. Some input supplies have a high impedance, thus placing the input capacitor on the input supply helps reduce the input impedance. This capacitor counteracts reactive input sources and improves transient response, input ripple, and PSRR. If the input supply has a high impedance over a large range of frequencies, several input capacitors can be used in parallel to lower the impedance over frequency. Use a higher-value capacitor if large, fast, rise-time load transients are anticipated, or if the device is located several inches from the input power source.

8.1.2 Dropout Voltage

Dropout voltage (V_{DO}) is defined as the input voltage minus the output voltage ($V_{\text{IN}} - V_{\text{OUT}}$) at the rated output current (I_{RATED}), where the pass transistor is fully on. I_{RATED} is the maximum I_{OUT} listed in the *Recommended Operating Conditions* table. The pass transistor is in the ohmic or triode region of operation, and acts as a switch. The dropout voltage indirectly specifies a minimum input voltage greater than the nominal programmed output voltage at which the output voltage is expected to stay in regulation. If the input voltage falls to less than the nominal output regulation, then the output voltage falls as well.

For a CMOS regulator, the dropout voltage is determined by the drain-source on-state resistance ($R_{\text{DS(ON)}}$) of the pass transistor. Therefore, if the linear regulator operates at less than the rated current, the dropout voltage for that current scales accordingly. The following equation calculates the $R_{\text{DS(ON)}}$ of the device.

$$R_{\text{DS(ON)}} = \frac{V_{\text{DO}}}{I_{\text{RATED}}} \quad (1)$$

8.1.3 Reverse Current

Excessive reverse current can damage this device. Reverse current flows through the intrinsic body diode of the pass transistor instead of the normal conducting channel. At high magnitudes, this current flow degrades the long-term reliability of the device.

Conditions where reverse current can occur are outlined in this section, all of which can exceed the absolute maximum rating of $V_{\text{OUT}} \leq V_{\text{IN}} + 0.3 \text{ V}$.

- If the device has a large C_{OUT} and the input supply collapses with little or no load current
- The output is biased when the input supply is not established
- The output is biased above the input supply

If reverse current flow is expected in the application, external protection is recommended to protect the device. Reverse current is not limited in the device, so external limiting is required if extended reverse voltage operation is anticipated.

8.1.4 Power Dissipation (P_D)

Circuit reliability requires consideration of the device power dissipation, location of the circuit on the printed circuit board (PCB), and correct sizing of the thermal plane. The PCB area around the regulator must have few or no other heat-generating devices that cause added thermal stress.

To first-order approximation, power dissipation in the regulator depends on the input-to-output voltage difference and load conditions. The following equation calculates power dissipation (P_D).

$$P_D = (V_{IN} - V_{OUT}) \times I_{OUT} \quad (2)$$

Note

Power dissipation can be minimized, and therefore greater efficiency can be achieved, by correct selection of the system voltage rails. For the lowest power dissipation use the minimum input voltage required for correct output regulation.

For devices with a thermal pad, the primary heat conduction path for the device package is through the thermal pad to the PCB. Solder the thermal pad to a copper pad area under the device. This pad area must contain an array of plated vias that conduct heat to additional copper planes for increased heat dissipation.

The maximum power dissipation determines the maximum allowable ambient temperature (T_A) for the device. According to the following equation, power dissipation and junction temperature are most often related by the junction-to-ambient thermal resistance ($R_{\theta JA}$) of the combined PCB and device package and the temperature of the ambient air (T_A).

$$T_J = T_A + (R_{\theta JA} \times P_D) \quad (3)$$

Thermal resistance ($R_{\theta JA}$) is highly dependent on the heat-spreading capability built into the particular PCB design, and therefore varies according to the total copper area, copper weight, and location of the planes. The junction-to-ambient thermal resistance listed in the *Thermal Information* table is determined by the JEDEC standard PCB and copper-spreading area, and is used as a relative measure of package thermal performance.

8.1.4.1 Thermal Performance Versus Copper Area

The most used thermal resistance parameter, $R_{\theta JA}$, is highly dependent on the heat-spreading capability built into the particular PCB design, and therefore varies according to the total copper area, copper weight, and location of the planes. The $R_{\theta JA}$ recorded in the *Thermal Information* table in the [Specifications](#) section is determined by the JEDEC standard (see [Figure 8-1](#)), PCB, and copper-spreading area, and is only used as a relative measure of package thermal performance. For a well-designed thermal layout, $R_{\theta JA}$ is actually the sum of the package junction-to-case (bottom) thermal resistance ($R_{\theta JCbot}$) plus the thermal resistance contribution by the PCB copper.

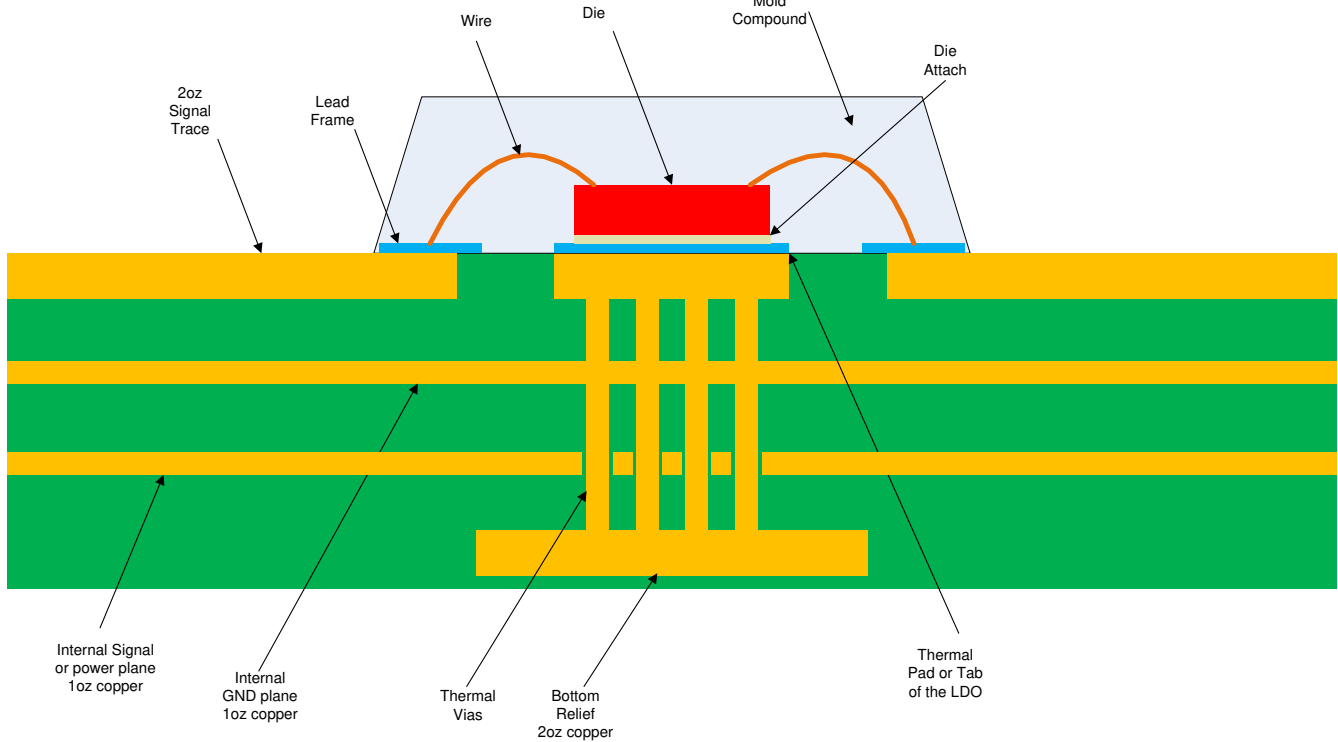

Figure 8-1. JEDEC Standard 2s2p PCB

Figure 8-2 and Figure 8-3 depict the functions of $R_{\theta JA}$ and ψ_{JB} versus copper area and thickness. These plots are generated with a 101.6-mm x 101.6-mm x 1.6-mm PCB of two and four layers. For the four-layer board, the inner planes use a 1-oz copper thickness. Outer layers are simulated with both a 1-oz and 2-oz copper thickness. A 4 x 4 array of thermal vias of 300- μ m drill diameter and 25- μ m Cu plating is located beneath the thermal pad of the device. The thermal vias connect the top layer, the bottom layer and, in the case of the 4-layer board, the first inner GND plane. Each of the layers has a copper plane of equal area.

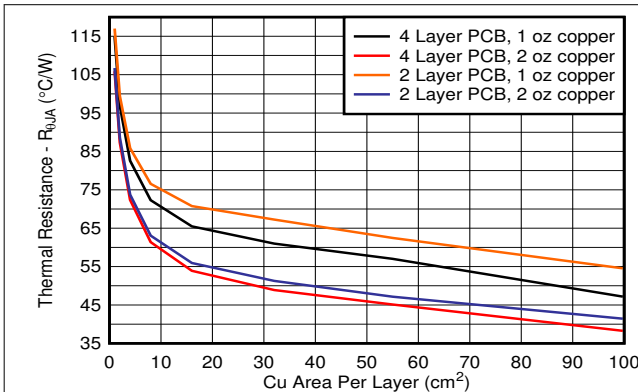

Figure 8-2. $R_{\theta JA}$ vs Copper Area 2s2p DCY Package

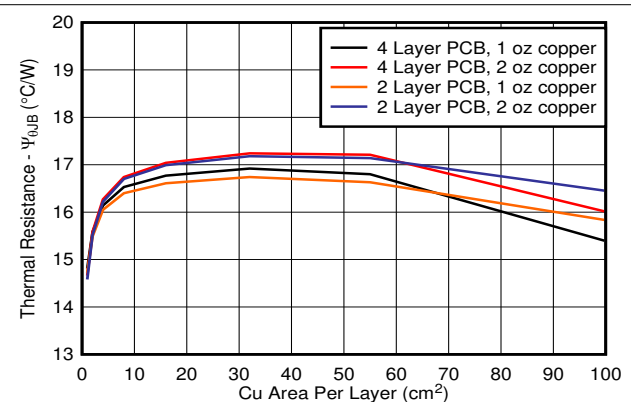

Figure 8-3. ψ_{JB} vs Copper Area 2s2p DCY Package

8.1.5 Estimating Junction Temperature

The JEDEC standard now recommends the use of psi (Ψ) thermal metrics to estimate the junction temperatures of the linear regulator when in-circuit on a typical PCB board application. These metrics are not thermal resistance parameters and instead offer a practical and relative way to estimate junction temperature. These psi metrics are determined to be significantly independent of the copper area available for heat-spreading. The *Thermal Information* table lists the primary thermal metrics, which are the junction-to-top characterization parameter (ψ_{JT}) and junction-to-board characterization parameter (ψ_{JB}). These parameters provide two methods for calculating the junction temperature (T_J), as described in the following equations. Use the junction-to-top characterization parameter (ψ_{JT}) with the temperature at the center-top of device package (T_T) to calculate the junction temperature. Use the junction-to-board characterization parameter (ψ_{JB}) with the PCB surface temperature 1 mm from the device package (T_B) to calculate the junction temperature.

$$T_J = T_T + \psi_{JT} \times P_D \quad (4)$$

where:

- P_D is the dissipated power
- T_T is the temperature at the center-top of the device package

$$T_J = T_B + \psi_{JB} \times P_D \quad (5)$$

where

- T_B is the PCB surface temperature measured 1 mm from the device package and centered on the package edge

For detailed information on the thermal metrics and how to use them, see the [Semiconductor and IC Package Thermal Metrics application report](#).

8.2 Typical Application

Figure 8-4 shows a typical application circuit for the TPS7B83-Q1. Use different values of external components, depending on the end application. An application may require a larger output capacitor during fast load steps in order to prevent a reset from occurring. TI recommends a low-ESR ceramic capacitor with a dielectric of type X5R or X7R.

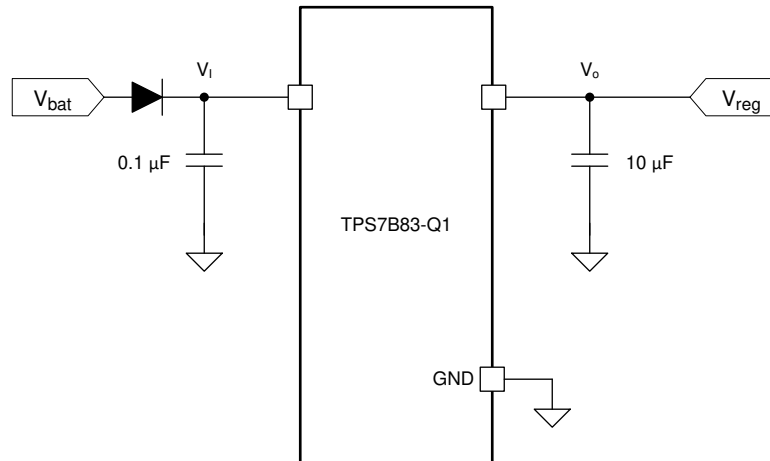

Figure 8-4. Typical Application Schematic for the TPS7B83-Q1

8.2.1 Design Requirements

For this design example, use the parameters listed in Table 8-1 as the input parameters.

Table 8-1. Design Parameters

DESIGN PARAMETER	EXAMPLE VALUE
Input voltage range	6 V to 40 V
Output voltage	5 V
Output current	100 mA
Output capacitor	10 µF

8.2.2 Detailed Design Procedure

8.2.2.1 Input Capacitor

The device requires an input decoupling capacitor, the value of which depends on the application. The typical recommended value for the decoupling capacitor is 1 µF. The voltage rating must be greater than the maximum input voltage.

8.2.2.2 Output Capacitor

The device requires an output capacitor to stabilize the output voltage. The capacitor value must be between 2.2 µF and 200 µF and the ESR range must be between 1 mΩ and 2 Ω. For this design a low ESR, 10-µF ceramic capacitor was used to improve transient performance.

8.2.3 Application Curves

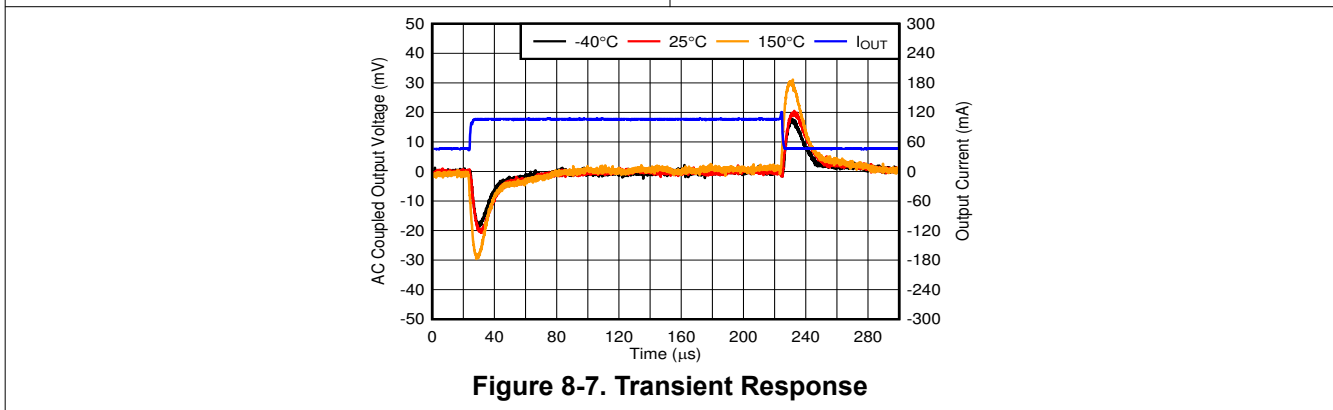
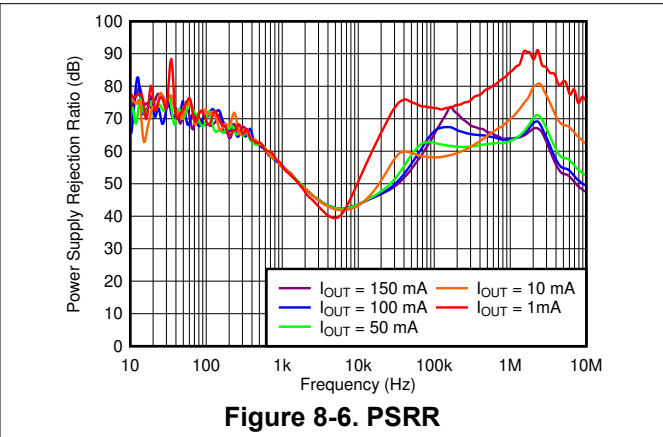
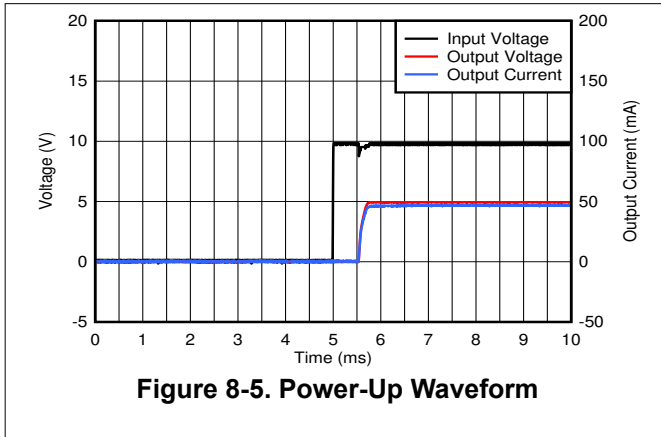

9 Power Supply Recommendations

This device is designed for operation from an input voltage supply with a range between 3 V and 40 V. This input supply must be well regulated. If the input supply is located more than a few inches from the TPS7B83-Q1, add an electrolytic capacitor and a ceramic bypass capacitor at the input.

10 Layout

10.1 Layout Guidelines

For best overall performance, place all circuit components on the same side of the circuit board and as near as practical to the respective LDO pin connections. Place ground return connections to the input and output capacitor, and to the LDO ground pin as close as possible to each other, connected by a wide, component-side, copper surface. The use of vias and long traces to the input and output capacitors is strongly discouraged and negatively affects system performance. TI also recommends a ground reference plane either embedded in the PCB itself or located on the bottom side of the PCB opposite the components. This reference plane serves to assure accuracy of the output voltage, shield noise, and behaves similarly to a thermal plane to spread (or sink) heat from the LDO device when connected to the thermal pad. In most applications, this ground plane is necessary to meet thermal requirements.

10.1.1 Package Mounting

Solder pad footprint recommendations for the TPS7B83-Q1 are available at the end of this document and at www.ti.com.

10.1.2 Board Layout Recommendations to Improve PSRR and Noise Performance

As depicted in [Figure 10-1](#), place the input and output capacitors close to the device for the layout of the TPS7B83-Q1. In order to enhance the thermal performance, place as many vias as possible around the device. These vias improve the heat transfer between the different GND planes in the PCB.

To improve ac performance such as PSRR, output noise, and transient response, TI recommends a board design with separate ground planes for IN and OUT, with each ground plane connected only at the GND pin of the device. In addition, the ground connection for the output capacitor must connect directly to the GND pin of the device.

Minimize equivalent series inductance (ESL) and ESR in order to maximize performance and ensure stability. Place each capacitor as close as possible to the device and on the same side of the PCB as the regulator itself.

Do not place any of the capacitors on the opposite side of the PCB from where the regulator is installed. TI strongly discourages the use of vias and long traces to connect the capacitors because these can negatively impact system performance and may even cause instability.

If possible, and to ensure the maximum performance specified in this document, use the same layout pattern used for the TPS7B83-Q1 evaluation board, available at www.ti.com.

10.2 Layout Example

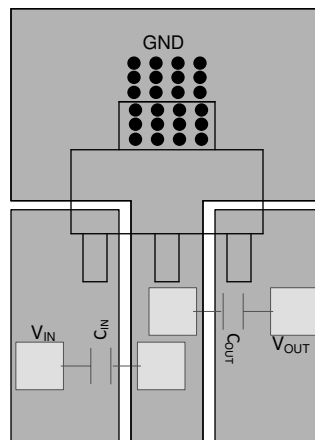

Figure 10-1. SOT-223 (DCY) Layout

11 Device and Documentation Support

11.1 Device Support

11.1.1 Device Nomenclature

Table 11-1. Device Nomenclature⁽¹⁾

PRODUCT	V _{OUT}
TPS7B83xxQDCYRQ1	xx is the nominal output voltage (for example, 33 = 3.3 V V; 50 = 5.0 V). Q indicates that this device is a grade-1 device in accordance with the AEC-Q100 standard. Q1 indicates that this device is an automotive grade (AEC-Q100) device.

(1) For the most current package and ordering information see the Package Option Addendum at the end of this document, or visit the device product folder on www.ti.com.

11.2 Receiving Notification of Documentation Updates

To receive notification of documentation updates, navigate to the device product folder on ti.com. Click on *Subscribe to updates* to register and receive a weekly digest of any product information that has changed. For change details, review the revision history included in any revised document.

11.3 Support Resources

[TI E2E™ support forums](#) are an engineer's go-to source for fast, verified answers and design help — straight from the experts. Search existing answers or ask your own question to get the quick design help you need.

Linked content is provided "AS IS" by the respective contributors. They do not constitute TI specifications and do not necessarily reflect TI's views; see TI's [Terms of Use](#).

11.4 Trademarks

TI E2E™ is a trademark of Texas Instruments.

All trademarks are the property of their respective owners.

11.5 Electrostatic Discharge Caution



This integrated circuit can be damaged by ESD. Texas Instruments recommends that all integrated circuits be handled with appropriate precautions. Failure to observe proper handling and installation procedures can cause damage.

ESD damage can range from subtle performance degradation to complete device failure. Precision integrated circuits may be more susceptible to damage because very small parametric changes could cause the device not to meet its published specifications.

11.6 Glossary

[TI Glossary](#) This glossary lists and explains terms, acronyms, and definitions.

12 Mechanical, Packaging, and Orderable Information

The following pages include mechanical, packaging, and orderable information. This information is the most current data available for the designated devices. This data is subject to change without notice and revision of this document. For browser-based versions of this data sheet, refer to the left-hand navigation.

PACKAGING INFORMATION

Orderable Device	Status (1)	Package Type	Package Drawing	Pins	Package Qty	Eco Plan (2)	Lead finish/ Ball material (6)	MSL Peak Temp (3)	Op Temp (°C)	Device Marking (4/5)	Samples
TPS7B8333QDCYRQ1	ACTIVE	SOT-223	DCY	4	2500	RoHS & Green	NIPDAU	Level-2-260C-1 YEAR	-40 to 125	7B8333	Samples
TPS7B8333QDCYRQ1M3	ACTIVE	SOT-223	DCY	4	2500	RoHS & Green	SN	Level-2-260C-1 YEAR	-40 to 125	7B8333	Samples
TPS7B8350QDCYRQ1	ACTIVE	SOT-223	DCY	4	2500	RoHS & Green	NIPDAU	Level-2-260C-1 YEAR	-40 to 125	7B8350	Samples
TPS7B8350QDCYRQ1M3	ACTIVE	SOT-223	DCY	4	2500	RoHS & Green	SN	Level-2-260C-1 YEAR	-40 to 125	7B8350	Samples

(1) The marketing status values are defined as follows:

ACTIVE: Product device recommended for new designs.

LIFEBUY: TI has announced that the device will be discontinued, and a lifetime-buy period is in effect.

NRND: Not recommended for new designs. Device is in production to support existing customers, but TI does not recommend using this part in a new design.

PREVIEW: Device has been announced but is not in production. Samples may or may not be available.

OBSELETE: TI has discontinued the production of the device.

(2) **RoHS:** TI defines "RoHS" to mean semiconductor products that are compliant with the current EU RoHS requirements for all 10 RoHS substances, including the requirement that RoHS substance do not exceed 0.1% by weight in homogeneous materials. Where designed to be soldered at high temperatures, "RoHS" products are suitable for use in specified lead-free processes. TI may reference these types of products as "Pb-Free".

RoHS Exempt: TI defines "RoHS Exempt" to mean products that contain lead but are compliant with EU RoHS pursuant to a specific EU RoHS exemption.

Green: TI defines "Green" to mean the content of Chlorine (Cl) and Bromine (Br) based flame retardants meet JS709B low halogen requirements of <=1000ppm threshold. Antimony trioxide based flame retardants must also meet the <=1000ppm threshold requirement.

(3) MSL, Peak Temp. - The Moisture Sensitivity Level rating according to the JEDEC industry standard classifications, and peak solder temperature.

(4) There may be additional marking, which relates to the logo, the lot trace code information, or the environmental category on the device.

(5) Multiple Device Markings will be inside parentheses. Only one Device Marking contained in parentheses and separated by a "-" will appear on a device. If a line is indented then it is a continuation of the previous line and the two combined represent the entire Device Marking for that device.

(6) Lead finish/Ball material - Orderable Devices may have multiple material finish options. Finish options are separated by a vertical ruled line. Lead finish/Ball material values may wrap to two lines if the finish value exceeds the maximum column width.

Important Information and Disclaimer:The information provided on this page represents TI's knowledge and belief as of the date that it is provided. TI bases its knowledge and belief on information provided by third parties, and makes no representation or warranty as to the accuracy of such information. Efforts are underway to better integrate information from third parties. TI has taken and

continues to take reasonable steps to provide representative and accurate information but may not have conducted destructive testing or chemical analysis on incoming materials and chemicals. TI and TI suppliers consider certain information to be proprietary, and thus CAS numbers and other limited information may not be available for release.

In no event shall TI's liability arising out of such information exceed the total purchase price of the TI part(s) at issue in this document sold by TI to Customer on an annual basis.

TAPE AND REEL INFORMATION

QUADRANT ASSIGNMENTS FOR PIN 1 ORIENTATION IN TAPE

*All dimensions are nominal

Device	Package Type	Package Drawing	Pins	SPQ	Reel Diameter (mm)	Reel Width W1 (mm)	A0 (mm)	B0 (mm)	K0 (mm)	P1 (mm)	W (mm)	Pin1 Quadrant
TPS7B8333QDCYRQ1M3	SOT-223	DCY	4	2500	330.0	12.4	7.05	7.4	1.9	8.0	12.0	Q3
TPS7B8350QDCYRQ1M3	SOT-223	DCY	4	2500	330.0	12.4	7.05	7.4	1.9	8.0	12.0	Q3

TAPE AND REEL BOX DIMENSIONS

*All dimensions are nominal

Device	Package Type	Package Drawing	Pins	SPQ	Length (mm)	Width (mm)	Height (mm)
TPS7B8333QDCYRQ1M3	SOT-223	DCY	4	2500	340.0	340.0	38.0
TPS7B8350QDCYRQ1M3	SOT-223	DCY	4	2500	366.0	364.0	50.0

DCY (R-PDSO-G4)

PLASTIC SMALL-OUTLINE

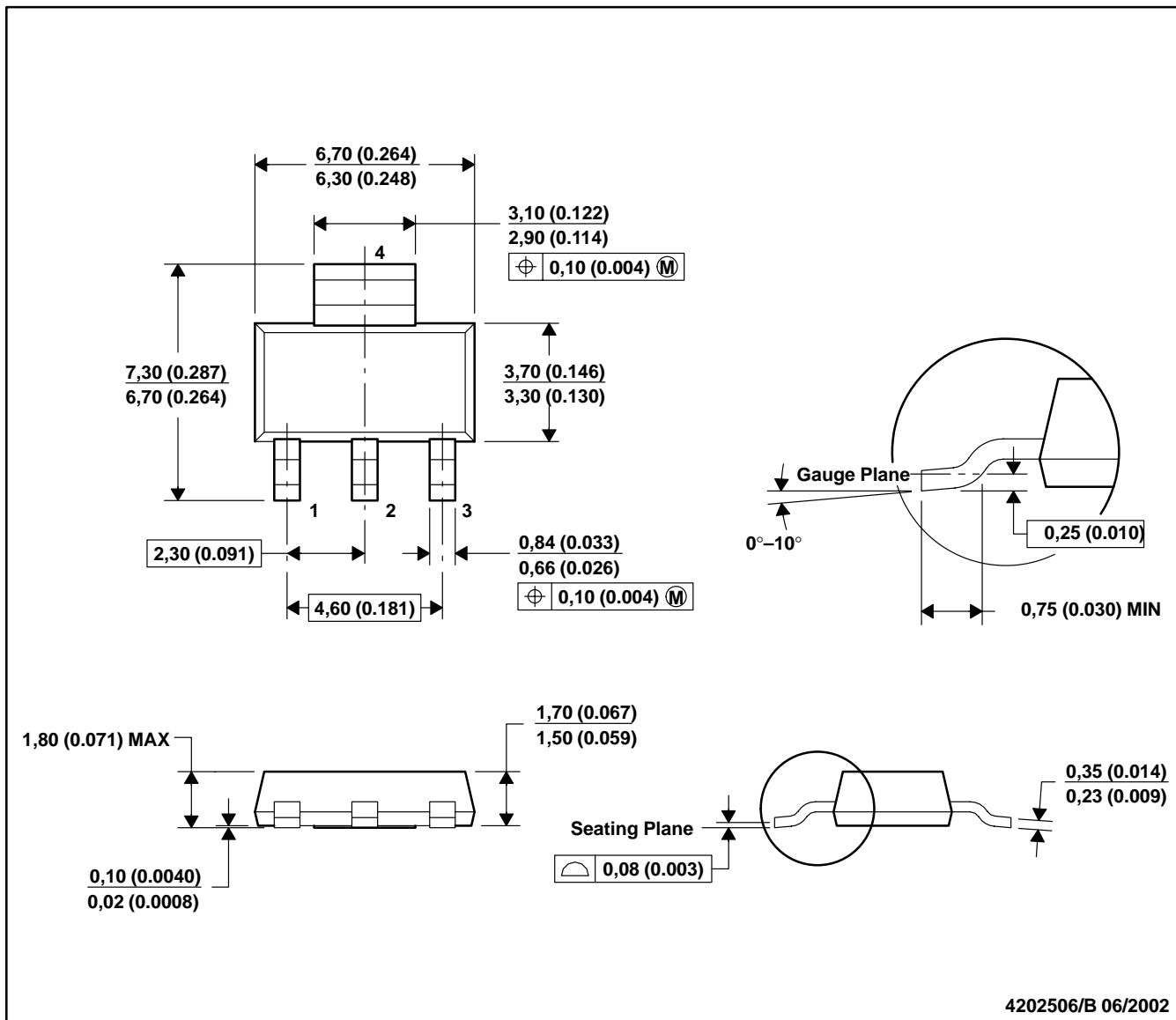

- NOTES: A. All linear dimensions are in millimeters (inches).
 B. This drawing is subject to change without notice.
 C. Body dimensions do not include mold flash or protrusion.
 D. Falls within JEDEC TO-261 Variation AA.

IMPORTANT NOTICE AND DISCLAIMER

TI PROVIDES TECHNICAL AND RELIABILITY DATA (INCLUDING DATA SHEETS), DESIGN RESOURCES (INCLUDING REFERENCE DESIGNS), APPLICATION OR OTHER DESIGN ADVICE, WEB TOOLS, SAFETY INFORMATION, AND OTHER RESOURCES "AS IS" AND WITH ALL FAULTS, AND DISCLAIMS ALL WARRANTIES, EXPRESS AND IMPLIED, INCLUDING WITHOUT LIMITATION ANY IMPLIED WARRANTIES OF MERCHANTABILITY, FITNESS FOR A PARTICULAR PURPOSE OR NON-INFRINGEMENT OF THIRD PARTY INTELLECTUAL PROPERTY RIGHTS.

These resources are intended for skilled developers designing with TI products. You are solely responsible for (1) selecting the appropriate TI products for your application, (2) designing, validating and testing your application, and (3) ensuring your application meets applicable standards, and any other safety, security, regulatory or other requirements.

These resources are subject to change without notice. TI grants you permission to use these resources only for development of an application that uses the TI products described in the resource. Other reproduction and display of these resources is prohibited. No license is granted to any other TI intellectual property right or to any third party intellectual property right. TI disclaims responsibility for, and you will fully indemnify TI and its representatives against, any claims, damages, costs, losses, and liabilities arising out of your use of these resources.

TI's products are provided subject to [TI's Terms of Sale](#) or other applicable terms available either on [ti.com](https://www.ti.com) or provided in conjunction with such TI products. TI's provision of these resources does not expand or otherwise alter TI's applicable warranties or warranty disclaimers for TI products.

TI objects to and rejects any additional or different terms you may have proposed.

Mailing Address: Texas Instruments, Post Office Box 655303, Dallas, Texas 75265
Copyright © 2023, Texas Instruments Incorporated