

# FAN1585A

## 5A Adjustable/Fixed Low Dropout Linear Regulator

### Features

- Fast transient response
- Low dropout voltage at up to 5A
- Load regulation: 0.05% typical
- Trimmed current limit
- On-chip thermal limiting
- Packages: TO-220, TO-252, TO-263 and TO-263 Centercut

### Applications

- AGTL+ bus supply for FC-PGA
- Low voltage logic supply
- Post regulator for switching supply
- 3.3V to 1.5V linear regulator
- 5V to 1.8V linear regulator

### Description

The FAN1585A, FAN1585A-1.5, and FAN1585A-1.8 are low dropout three-terminal regulators with 5A output current capability. These devices have been optimized for low voltage applications including  $V_{TT}$  bus termination for FC-PGA, where transient response and minimum input voltage are critical. The FAN1585A-1.5 offers fixed 1.5V with 5A current capabilities for AGTL+ bus  $V_{TT}$  termination for FC-PGA. The FAN1585A is ideal for low voltage microprocessor applications requiring a regulated output from 1.5V to 3.6V with an input supply of 5V or less, or for FC-PGA applications with significant trace resistance.

Current limit is trimmed to ensure specified output current and controlled short-circuit current. On-chip thermal limiting provides protection against any combination of overload and ambient temperature that would create excessive junction temperatures.

The FAN1585A series regulators are available in the industry-standard TO-220, TO-252, TO-263 and TO-263 Centercut power packages.

### Typical Applications

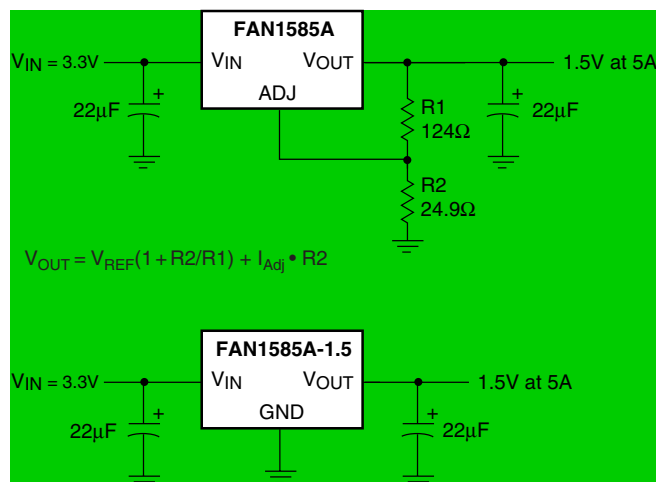

## Pin Assignments

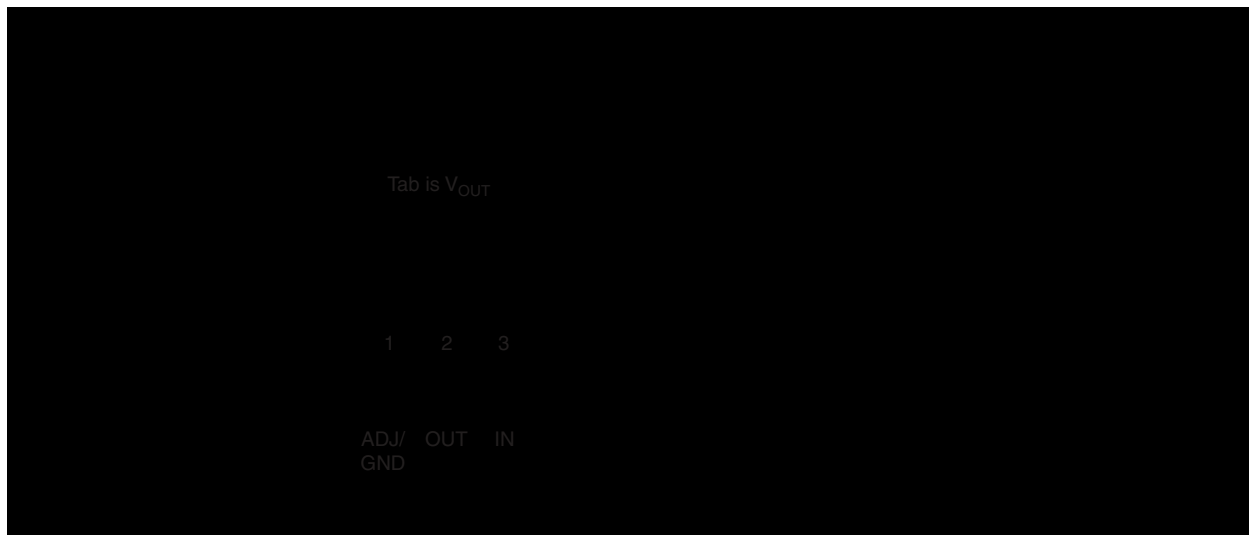

\*With package soldered to 0.5 square inch copper area over backside ground plane or internal power plane,  $\theta_{JA}$  can vary from 30°C/W to more than 40°C/W. Other mounting techniques can provide a thermal resistance lower than 30°C/W.

## Absolute Maximum Ratings

Parameter	Min.	Max.	Unit
V <sub>IN</sub>		18	V
Operating Junction Temperature Range	0	125	°C
Storage Temperature Range	-65	150	°C
Lead Temperature (Soldering, 10 sec.)		300	°C

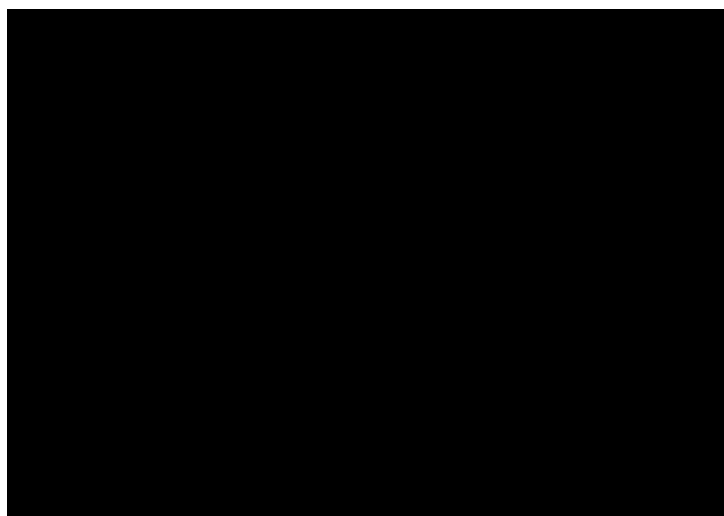

Absolute Maximum Safe Operating Area

## Electrical Characteristics

T<sub>j</sub> = 25°C unless otherwise specified.

The • denotes specifications which apply over the specified operating temperature range.

Parameter	Conditions		Min.	Typ.	Max	Units
Reference Voltage <sup>3</sup>	$1.5V \leq (V_{IN} - V_{OUT}) \leq 5.75V$ , $10mA \leq I_{OUT} \leq 5A$	•	1.225 (-2%)	1.250	1.275 (+2%)	V
Output Voltage <sup>4</sup>	$3.0V \leq V_{IN} \leq 8V$ $10mA \leq I_{OUT} \leq 5A$	•	1.47	1.5	1.53	V
Output Voltage <sup>5</sup>	$3.3V \leq V_{IN} \leq 8.3V$ $10mA \leq I_{OUT} \leq 5A$	•	1.764	1.8	1.836	V
Line Regulation <sup>1, 2</sup>	$(V_{OUT} + 1.5V) \leq V_{IN} \leq 12V$ , $I_{OUT} = 10mA$	•		0.005	0.2	%
Load Regulation <sup>1, 2, 3</sup>	$(V_{IN} - V_{OUT}) = 3V$ , $10mA \leq I_{OUT} \leq 5A$	•		0.05	0.5	%
Dropout Voltage	$\Delta V_{REF} = 1\%$ , $I_{OUT} = 5A$	•		1.150	1.300	V
Current Limit	$(V_{IN} - V_{OUT}) = 2V$	•	5.1	5.9		A
Adjust Pin Current <sup>3</sup>		•		35	120	μA
Adjust Pin Current Change <sup>3</sup>	$1.5V \leq (V_{IN} - V_{OUT}) \leq 5.75V$ , $10mA \leq I_{OUT} \leq 5A$	•		0.2	5	μA
Minimum Load Current	$1.5V \leq (V_{IN} - V_{OUT}) \leq 12V$	•	10			mA
Quiescent Current	$V_{IN} = 5V$	•		4	13	mA
Ripple Rejection	$f = 120Hz$ , $C_{OUT} = 22\mu F$ Tantalum, $(V_{IN} - V_{OUT}) = 3V$ , $I_{OUT} = 5A$		60	72		dB
Thermal Regulation	$T_A = 25^\circ C$ , 30ms pulse			0.004	0.02	%/W
Temperature Stability		•		0.5		%
Long-Term Stability	$T_A = 125^\circ C$ , 1000 hrs.			0.03	1.0	%
RMS Output Noise (% of V <sub>OUT</sub> )	$T_A = 25^\circ C$ , $10Hz \leq f \leq 10kHz$			0.003		%
Thermal Resistance, Junction to Case	TO-220, TO-252, TO-263, and TO-263 CC			3		°C/W
Thermal Shutdown				150		°C

### Notes:

1. See thermal regulation specifications for changes in output voltage due to heating effects. Load and line regulation are measured at a constant junction temperature by low duty cycle pulse testing.
2. Line and load regulation are guaranteed up to the maximum power dissipation. Power dissipation is determined by input/output differential and the output current. Guaranteed maximum output power will not be available over the full input/output voltage range.
3. FAN1585A only.
4. FAN1585A-1.5 only.
5. FAN1585A-1.8 only.

## Typical Performance Characteristics

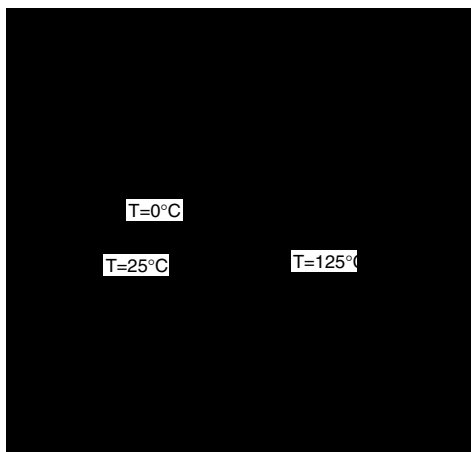

Figure 1. Dropout Voltage vs. Output Current

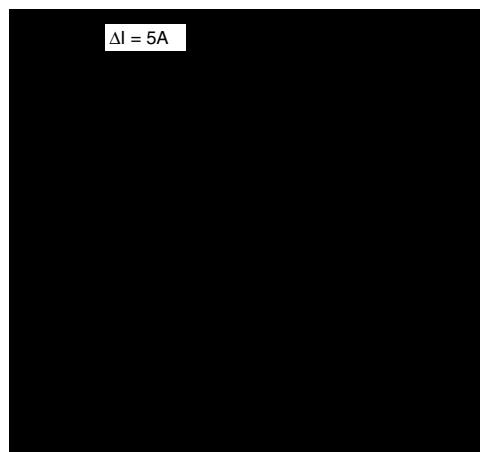

Figure 2. Load Regulation vs. Temperature

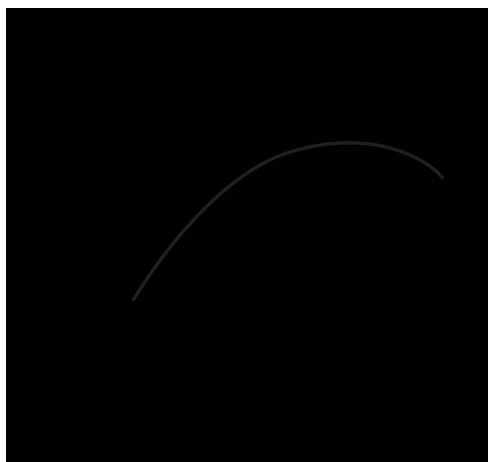

Figure 3. Reference Voltage vs. Temperature

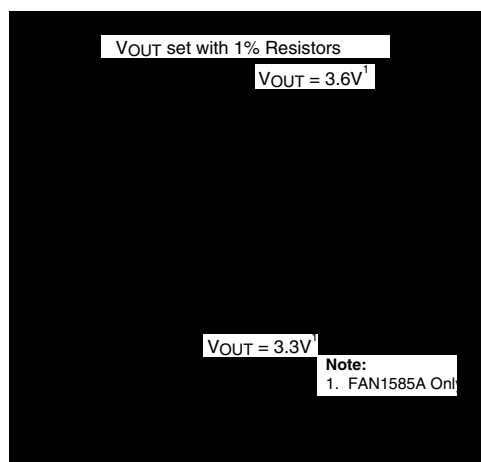

Figure 4. Output Voltage vs. Temperature



Figure 5. Minimum Load Current vs. Temperature



Figure 6. Adjust Pin Current vs. Temperature

### Typical Performance Characteristics (continued)

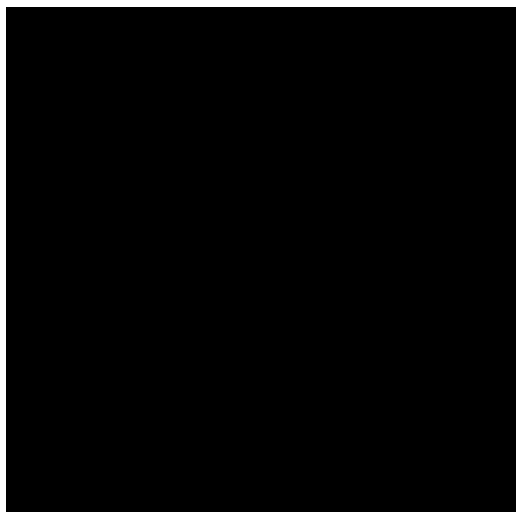

Figure 7. Short-Circuit Current vs. Temperature

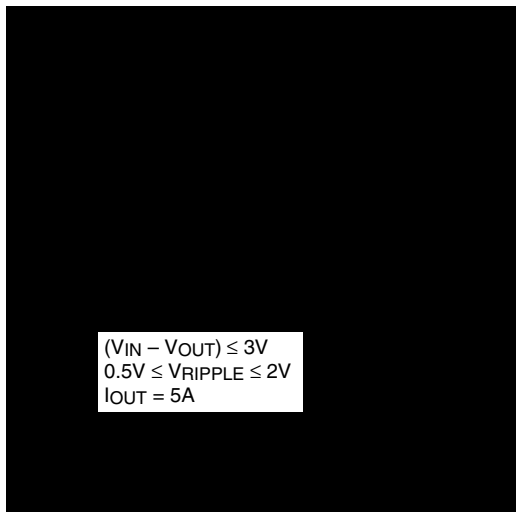

Figure 8. Ripple Rejection vs. Frequency

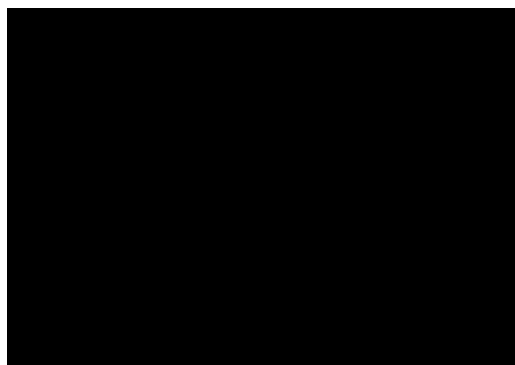

Figure 9. Maximum Power Dissipation

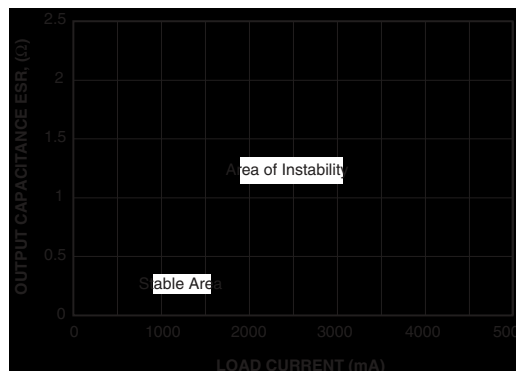

Figure 10. Stability Region  $V_{IN}/V_{OUT} = 5V/1.5V$

## Applications Information

### General

The FAN1585A and FAN1585A-1.5 are three-terminal regulators optimized for GTL+  $V_{TT}$  termination and logic applications. These devices are short-circuit protected and offer thermal shutdown to turn off the regulator when the junction temperature exceeds about 150°C. The FAN1585A series provides low dropout voltage and fast transient response. Frequency compensation uses capacitors with low ESR while still maintaining stability. This is critical in addressing the needs of low voltage high speed microprocessor buses like GTL+.

### Stability

The FAN1585A series requires an output capacitor as a part of the frequency compensation. It is recommended to use a 22 $\mu$ F solid tantalum or a 100  $\mu$ F aluminum electrolytic on the output to ensure stability. The frequency compensation of these devices optimizes the frequency response with low ESR capacitors. In general, it is suggested to use capacitors with an ESR of <300m $\Omega$ . It is also recommended to use bypass capacitors such as a 22 $\mu$ F tantalum or a 100 $\mu$ F aluminum on the adjust pin of the FAN1585A for low ripple and fast transient response. When these bypassing capacitors are not used at the adjust pin, larger values of output capacitors provide equally good results. Refer to Typical Performance Characteristics for graph of stability of output capacitance ESR vs load current.

### Protection Diodes

In normal operation, the FAN1585A series does not require any protection diodes. For the FAN1585A, internal resistors limit internal current paths on the adjust pin. Therefore, even with bypass capacitors on the adjust pin, no protection diode is needed to ensure device safety under short-circuit conditions.

A protection diode between the input and output pins is usually not needed. An internal diode between the input and the output pins on the FAN1585A series can handle microsecond surge currents of 50A to 100A. Even with large value output capacitors it is difficult to obtain those values of surge currents in normal operation. Only with large values of output capacitance, such as 1000 $\mu$ F to 5000 $\mu$ F, and with the input pin instantaneously shorted to ground can damage occur. A crowbar circuit at the input can generate those levels of current; a diode from output to input is then recommended, as shown in Figure 10. Usually, normal power supply cycling or system “hot plugging and unplugging” will not generate current large enough to do any damage.

The adjust pin can be driven on a transient basis  $\pm 7V$  with respect to the output, without any device degradation. As with any IC regulator, exceeding the maximum input-to-output voltage differential causes the internal transistors to

break down and none of the protection circuitry is then functional.



Figure 10. Optional Protection

### Ripple Rejection

In applications that require improved ripple rejection, a bypass capacitor from the adjust pin of the FAN1585A to ground reduces the output ripple by the ratio of  $V_{OUT}/1.25V$ . The impedance of the adjust pin capacitor at the ripple frequency should be less than the value of R1 (typically in the range of 100 $\Omega$  to 120 $\Omega$ ) in the feedback divider network in Figure 10. Therefore, the value of the required adjust pin capacitor is a function of the input ripple frequency. For example, if R1 equals 100 $\Omega$  and the ripple frequency equals 120Hz, the adjust pin capacitor should be 22 $\mu$ F. At 10kHz, only 0.22 $\mu$ F is needed.

### Output Voltage

The FAN1585A regulator develops a 1.25V reference voltage between the output pin and the adjust pin (see Figure 11). Placing a resistor R1 between these two terminals causes a constant current to flow through R1 and down through R2 to set the overall output voltage. Normally, this current is the specified minimum load current of 10mA.

The current out of the adjust pin adds to the current from R1 and is typically 35 $\mu$ A. Its output voltage contribution is small and only needs consideration when a very precise output voltage setting is required.



Figure 11. Basic Regulator Circuit

**Load Regulation**

It is not possible to provide true remote load sensing because the FAN1585A series are three-terminal devices. Load regulation is limited by the resistance of the wire connecting the regulators to the load. Load regulation per the data sheet specification is measured at the bottom of the package.

For fixed voltage devices, negative side sensing is a true Kelvin connection with the ground pin of the device returned to the negative side of the load. This is illustrated in Figure 12.

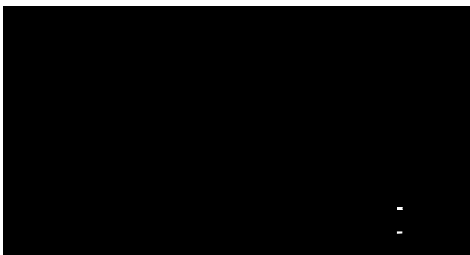

Figure 12. Connection for Best Load Regulation

For adjustable voltage devices, negative side sensing is a true Kelvin connection with the bottom of the output divider returned to the negative side of the load. The best load regulation is obtained when the top of the resistor divider R1 connects directly to the regulator output and not to the load. Figure 13 illustrates this point.

If R1 connects to the load, then the effective resistance between the regulator and the load would be:

$$R_p \times (1 + R_2/R_1), R_p = \text{Parasitic Line Resistance}$$

The connection shown in Figure 13 does not multiply  $R_p$  by the divider ratio. As an example,  $R_p$  is about four milliohms per foot with 16-gauge wire. This translates to 4mV per foot at 1A load current. At higher load currents, this drop represents a significant percentage of the overall regulation. It is important to keep the positive lead between the regulator and the load as short as possible and to use large wire or PC board traces.

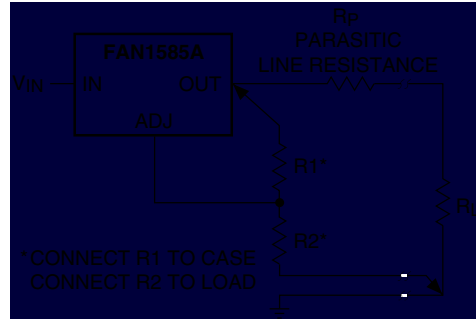

Figure 13. Connection for Best Load Regulation

**Thermal Considerations**

The FAN1585A series protect themselves under overload conditions with internal power and thermal limiting circuitry. However, for normal continuous load conditions, do not exceed maximum junction temperature ratings. It is important to consider all sources of thermal resistance from junction-to-ambient. These sources include the junction-to-case resistance, the case-to-heat sink interface resistance, and the heat sink resistance. Thermal resistance specifications have been developed to more accurately reflect device temperature and ensure safe operating temperatures.

For example, look at using an FAN1585AT to generate 5A @ 1.5V ± 2% from a 3.3V source (3.2V to 3.6V).

**Assumptions:**

- $V_{IN} = 3.6V$  worst case
- $V_{OUT} = 1.46V$  worst case
- $I_{OUT} = 5A$  continuous
- $T_A = 50^\circ C$
- $\theta_{Case-to-Ambient} = 3^\circ C/W$  (assuming both a heatsink and a thermally conductive material)

The power dissipation in this application is:

$$P_D = (V_{IN} - V_{OUT}) * (I_{OUT}) = (3.6 - 1.46) * (5) = 10.7W$$

From the specification table:

$$T_J = T_A + (P_D) * (\theta_{Case-to-Ambient} + \theta_{JC}) = 50 + (10.7) * (3 + 3) = 115^\circ C$$

The junction temperature is below the maximum rating.

Junction-to-case thermal resistance is specified from the IC junction to the bottom of the case directly below the die. This is the lowest resistance path for heat flow. Proper mounting ensures the best thermal flow from this area of the package to the heat sink. Use of a thermally conductive material at the

case-to-heat sink interface is recommended. Use a thermally conductive spacer if the case of the device must be electrically isolated and include its contribution to the total thermal resistance. The cases of the FAN1585A series are directly connected to the output of the device.

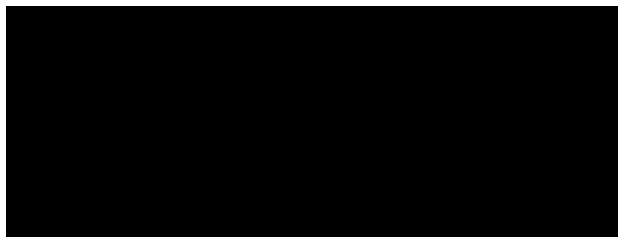

Figure 14. Application Circuit (FAN1585A)

Table 1. Bill of Materials for Application Circuit for the FAN1585A

Item	Quantity	Manufacturer	Part Number	Description
C1	1	Xicon	L10V22	22 $\mu$ F, 10V Aluminum
C2, C3	2	Xicon	L10V100	100 $\mu$ F, 10V Aluminum
R1	1	Generic		124 $\Omega$ , 1%
R2	1	Generic		24.9 $\Omega$ , 1%
U1	1	Fairchild	FAN1585AT	5A Regulator

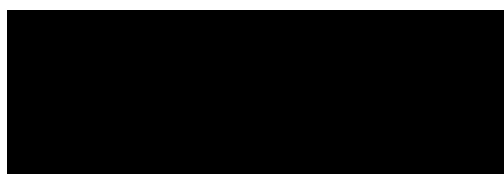

Figure 15. Application Circuit (FAN1585A-1.5)

Table 2. Bill of Materials for Application Circuit for the FAN1585A-1.5

Item	Quantity	Manufacturer	Part Number	Description
C1	1	Xicon	L10V22	22 $\mu$ F, 10V Aluminum
C3	1	Xicon	L10V100	100 $\mu$ F, 10V Aluminum
U1	1	Fairchild	FAN1585AT-1.5	5A Regulator



# Mechanical Dimensions

## 3-Lead TO-263 Package

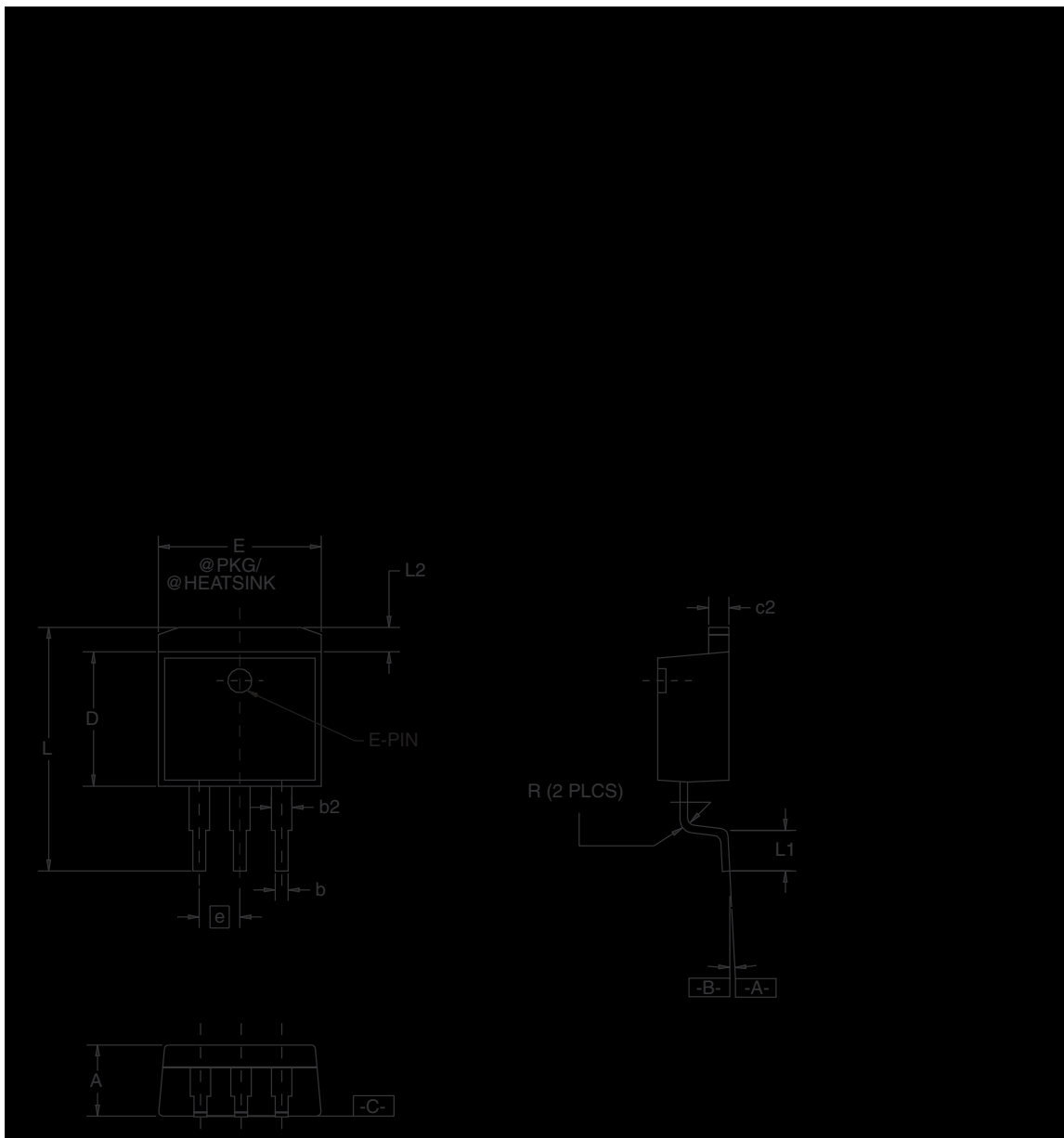

# Mechanical Dimensions (continued)

## 3-Lead TO-263 Center Cut Package

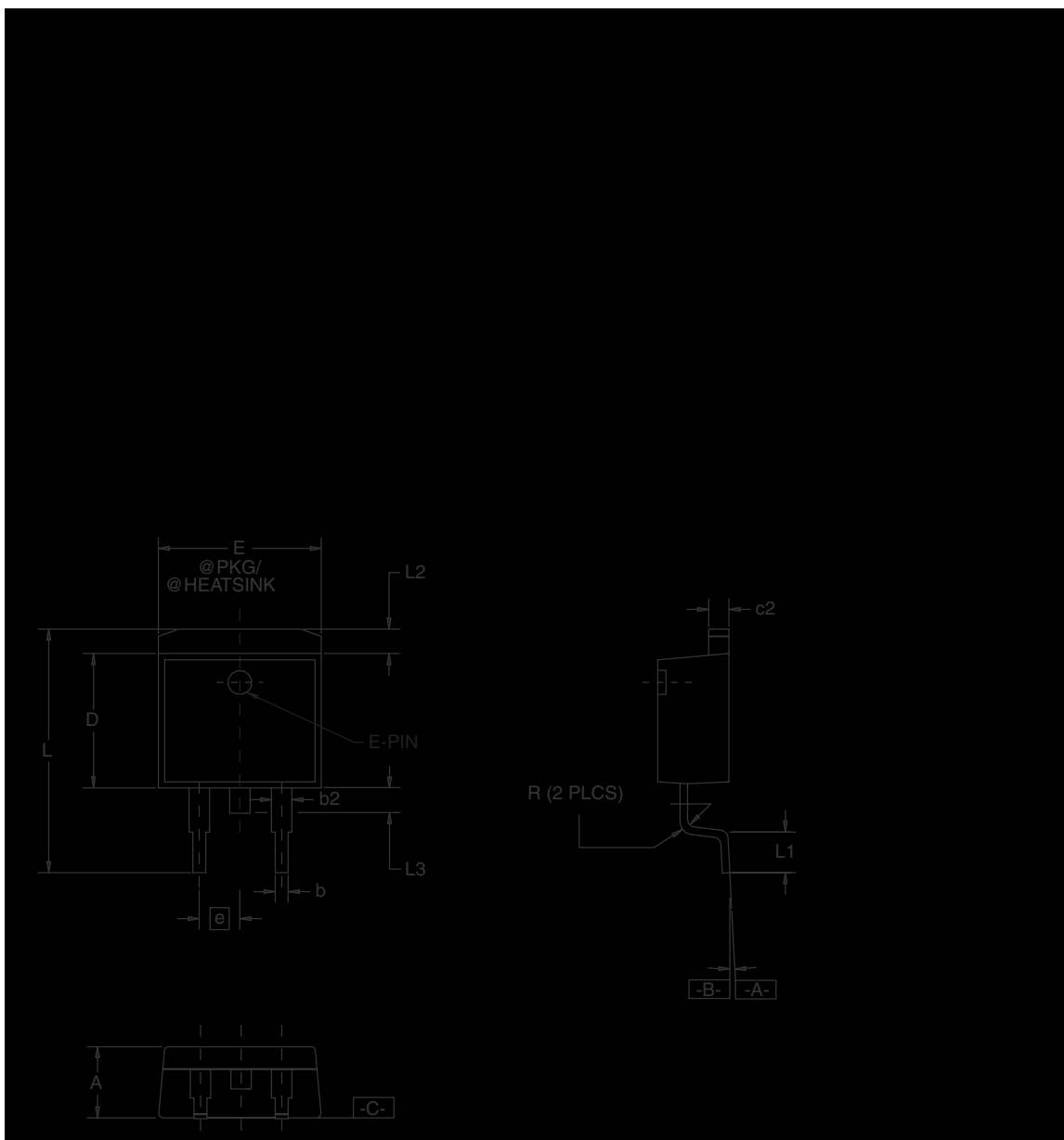

---

## Mechanical Dimensions (continued)

### 3-Lead TO-220 Package

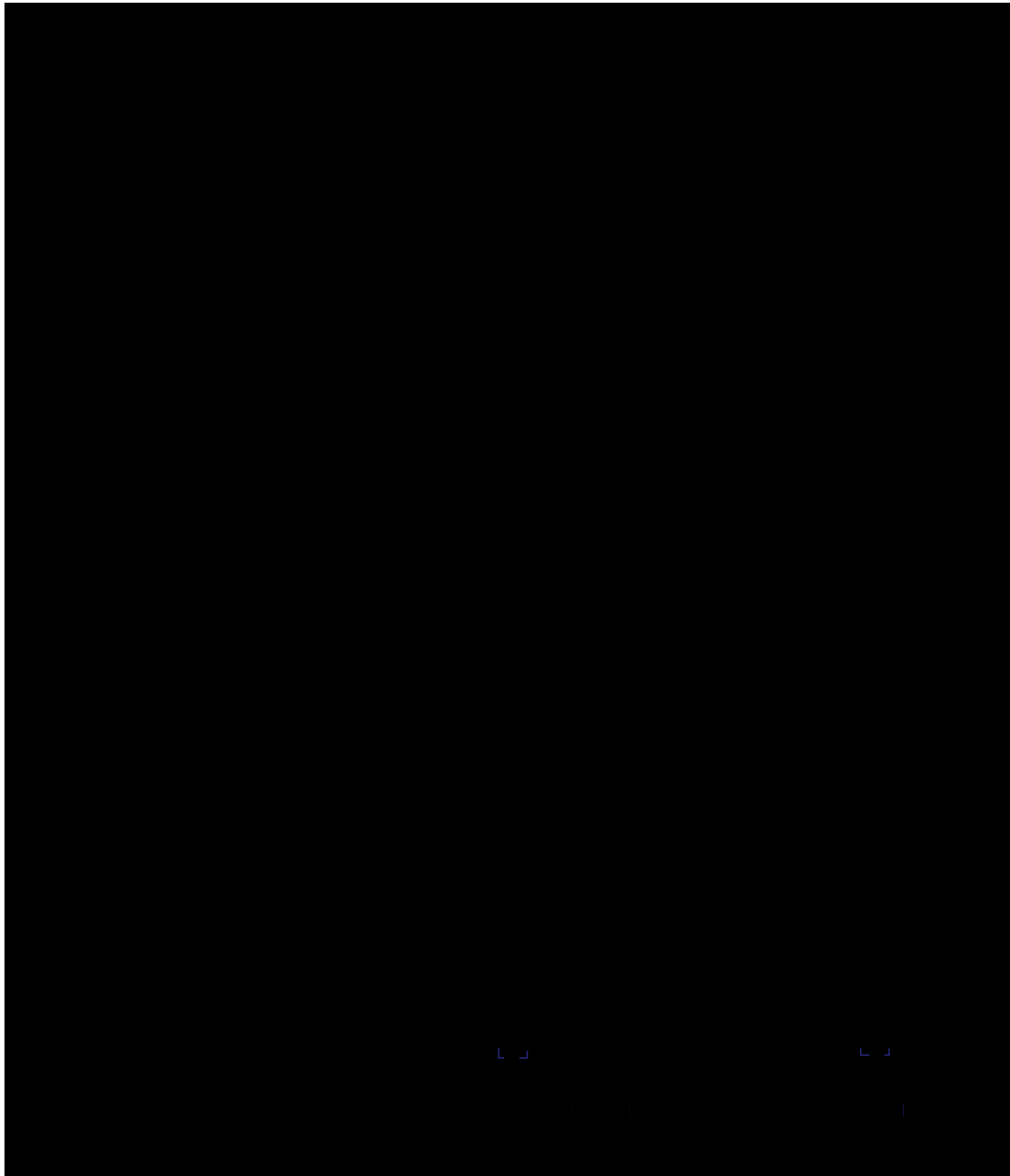

# Mechanical Dimensions (continued)

## 3-Lead TO-252 Package

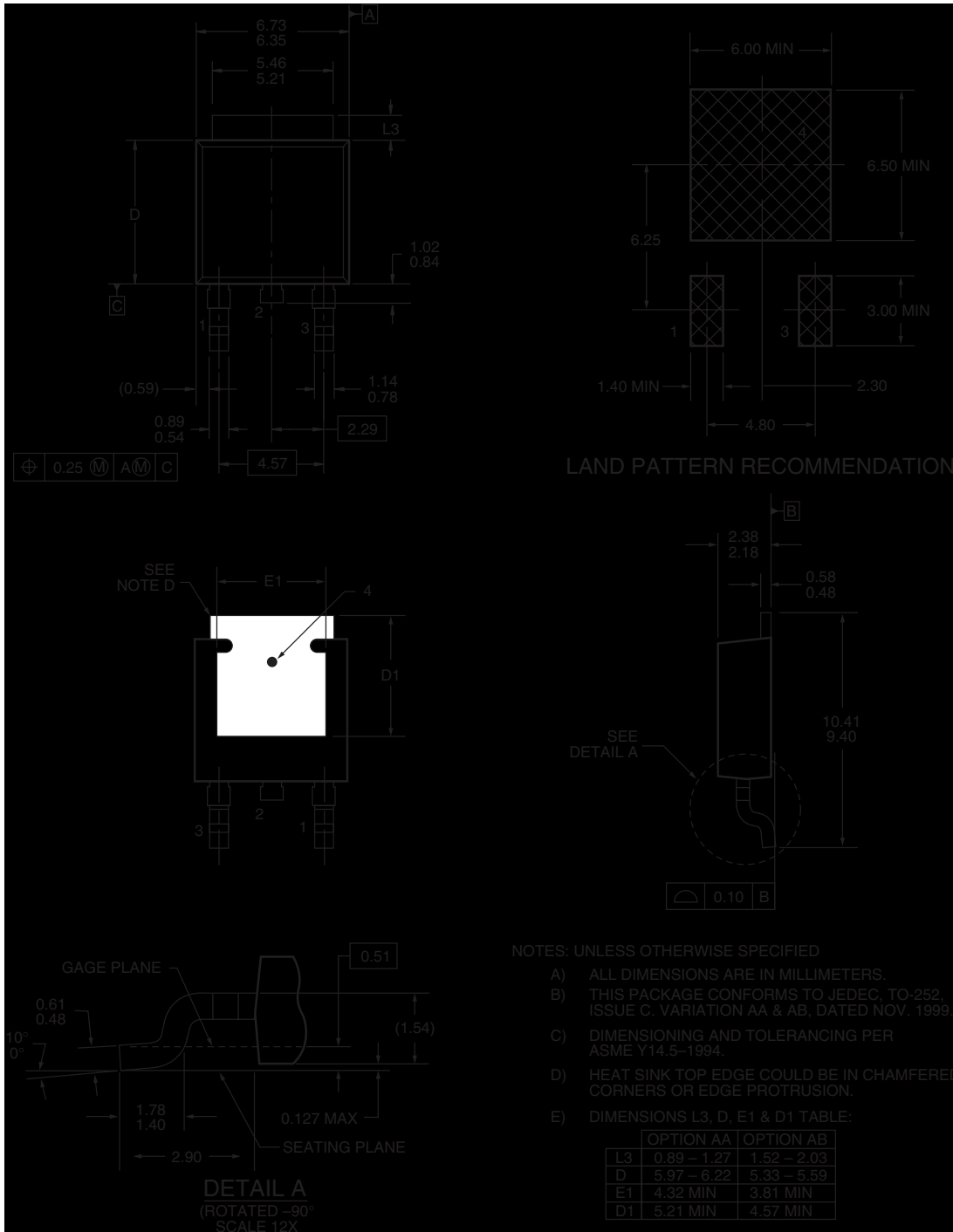

## Ordering Information

Product Number	Package
FAN1585AMX	TO-263 in Tape and Reel
FAN1585AMCX	TO-263 Center Cut in Tape and Reel
FAN1585AT	TO-220
FAN1585AM15X	TO-263 in Tape and Reel
FAN1585AMC15X	TO-263 Center Cut in Tape and Reel
FAN1585AT15	TO-220
FAN1585AM18X	TO-263 in Tape and Reel
FAN1585AMC18X	TO-263 Center Cut in Tape and Reel
FAN1585AT18	TO-220
FAN1585AD	TO-252
FAN1585ADX	TO-252 in Tape and Reel

### DISCLAIMER

FAIRCHILD SEMICONDUCTOR RESERVES THE RIGHT TO MAKE CHANGES WITHOUT FURTHER NOTICE TO ANY PRODUCTS HEREIN TO IMPROVE RELIABILITY, FUNCTION OR DESIGN. FAIRCHILD DOES NOT ASSUME ANY LIABILITY ARISING OUT OF THE APPLICATION OR USE OF ANY PRODUCT OR CIRCUIT DESCRIBED HEREIN; NEITHER DOES IT CONVEY ANY LICENSE UNDER ITS PATENT RIGHTS, NOR THE RIGHTS OF OTHERS.

### LIFE SUPPORT POLICY

FAIRCHILD'S PRODUCTS ARE NOT AUTHORIZED FOR USE AS CRITICAL COMPONENTS IN LIFE SUPPORT DEVICES OR SYSTEMS WITHOUT THE EXPRESS WRITTEN APPROVAL OF THE PRESIDENT OF FAIRCHILD SEMICONDUCTOR CORPORATION. As used herein:

1. Life support devices or systems are devices or systems which, (a) are intended for surgical implant into the body, or (b) support or sustain life, or (c) whose failure to perform when properly used in accordance with instructions for use provided in the labeling, can be reasonably expected to result in significant injury to the user.
2. A critical component is any component of a life support device or system whose failure to perform can be reasonably expected to cause the failure of the life support device or system, or to affect its safety or effectiveness.