

### DESCRIPTION

The MP21148 is a monolithic, step-down, switch-mode converter with built-in, internal power MOSFETs. It can achieve 1A of continuous output current from a 2.3V-to-5.5V input voltage with excellent load and line regulation. The output voltage can be regulated as low as 0.6V.

The constant-on-time control scheme in forced CCM provides a fast transient response, low output voltage ripple, and eases loop stabilization. Fault protections include cycle-by-cycle current limiting and thermal shutdown.

The MP21148 is available in an ultra-small QFN-6 (1.0mmx1.5mm) package and requires a minimal number of readily available, standard, external components.

The MP21148 is ideal for a wide range of applications including high-performance DSPs, wireless power, portable and mobile devices, and other low-power systems.

### FEATURES

- 2.4MHz Switching Frequency
- EN for Power Sequencing
- Wide 2.3V-to-5.5V Operating Input Range
- Output Adjustable from 0.6V
- Up to 1A of Output Current
- 120mΩ and 80mΩ Internal Power MOSFET Switches
- Output Discharging
- 100% Duty Cycle
- Short-Circuit Protection (SCP) with Hiccup Mode
- Stable with Low ESR Output Ceramic Capacitors
- Available in a QFN-6 (1.0mmx1.5mm) Package
- Continuous Conduction Mode (CCM)

### APPLICATIONS

- Wireless/Networking Cards
- Portable and Mobile Devices
- Battery-Powered /Wearable Devices
- Low-Voltage I/O System Power

All MPS parts are lead-free, halogen-free, and adhere to the RoHS directive. For MPS green status, please visit the MPS website under Quality Assurance. "MPS" and "The Future of Analog IC Technology" are registered trademarks of Monolithic Power Systems, Inc.

### TYPICAL APPLICATION

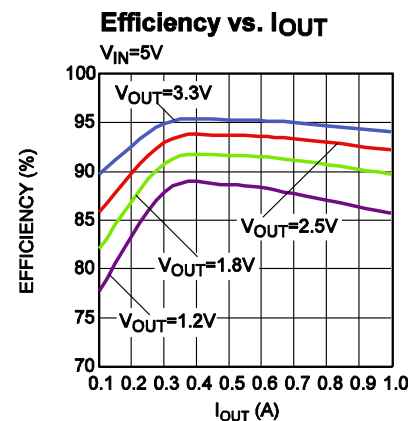
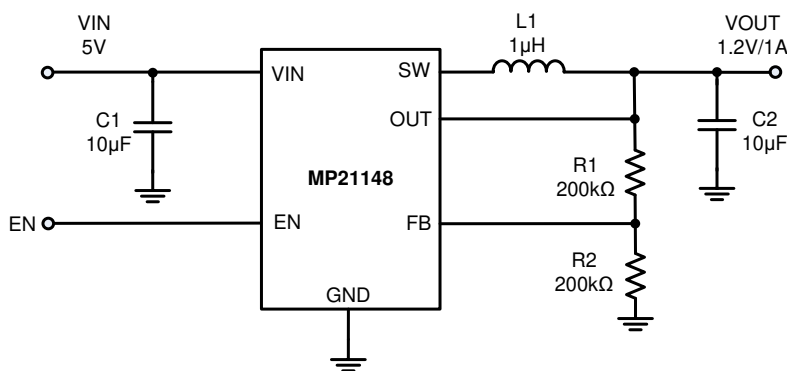

### ORDERING INFORMATION

Part Number	Package	Top Marking	V <sub>OUT</sub> Range
MP21148GQD*	QFN-6 (1mmx1.5mm)	See Below	Adjustable

\* For Tape & Reel, add suffix -Z (e.g. MP21148GQD-Z)

### TOP MARKING

—  
ET  
LL

ET: Product code of MP21148GQD  
LL: Lot number

### PACKAGE REFERENCE

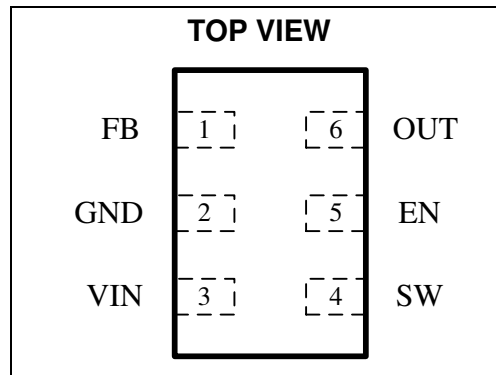

#### ABSOLUTE MAXIMUM RATINGS <sup>(1)</sup>

Supply voltage (V<sub>IN</sub>) .....6V  
V<sub>SW</sub>.....-0.3V (-5V for <10ns) to  
6V (8V for <10ns or 10V for <3ns)  
All other pins..... -0.3V to 6V  
Junction temperature ..... 150°C  
Lead temperature ..... 260°C  
Continuous power dissipation (T<sub>A</sub> = +25°C) <sup>(2)</sup>  
.....0.6W  
Storage temperature..... -65°C to +150°C

#### Recommended Operating Conditions <sup>(3)</sup>

Supply voltage (V<sub>IN</sub>) ..... 2.3V to 5.5V  
Operating junction temp. (T<sub>J</sub>)... -40°C to +125°C

**Thermal Resistance <sup>(4)</sup>**      **θ<sub>JA</sub>**      **θ<sub>JC</sub>**  
QFN-6 (1mmx1.5mm)..... 220.....110...°C/W

#### NOTES:

- 1) Exceeding these ratings may damage the device.
- 2) The maximum allowable power dissipation is a function of the maximum junction temperature T<sub>J</sub> (MAX), the junction-to-ambient thermal resistance θ<sub>JA</sub>, and the ambient temperature T<sub>A</sub>. The maximum allowable continuous power dissipation at any ambient temperature is calculated by P<sub>D</sub> (MAX) = (T<sub>J</sub> (MAX)-T<sub>A</sub>)/θ<sub>JA</sub>. Exceeding the maximum allowable power dissipation produces an excessive die temperature, causing the regulator to go into thermal shutdown. Internal thermal shutdown circuitry protects the device from permanent damage.
- 3) The device is not guaranteed to function outside of its operating conditions.
- 4) Measured on JESD51-7, 4-layer PCB.

## ELECTRICAL CHARACTERISTICS

$V_{IN} = 3.6V$ ,  $T_J = -40^{\circ}C$  to  $+125^{\circ}C$ . Typical value is tested at  $T_J = +25^{\circ}C$ . The limit over temperature is guaranteed by characterization, unless otherwise noted.

Parameter	Symbol	Condition	Min	Typ	Max	Units
Feedback voltage	$V_{FB}$	$2.3V \leq V_{IN} \leq 5.5V$ , $T_J = 25^{\circ}C$	594	600	606	mV
		$T_J = -40^{\circ}C$ to $+125^{\circ}C$	588		612	
Feedback current	$I_{FB}$	$V_{FB} = 0.63V$		50	100	nA
P-FET switch on resistance	$R_{DSON\ P}$			120		m $\Omega$
N-FET switch on resistance	$R_{DSON\ N}$			80		m $\Omega$
Switch leakage current		$V_{EN} = 0V$ , $T_J = 25^{\circ}C$		0	1	$\mu A$
P-FET peak current limit		Sourcing		2		A
NFET valley current limit		Sourcing, valley current limit		1.2		A
On time	$T_{ON}$	$V_{IN} = 5V$ , $V_{OUT} = 1.2V$		100		ns
		$V_{IN} = 3.6V$ , $V_{OUT} = 1.2V$		140		
Switching frequency	$f_s$	$V_{IN} = 5V$ , $V_{OUT} = 1.2V$ , $I_{OUT} = 500mA$ , $T_J = 25^{\circ}C^{(5)}$		2400		kHz
		$V_{IN} = 5V$ , $V_{OUT} = 1.2V$ , $I_{OUT} = 500mA$ , $T_J = -40^{\circ}C$ to $+125^{\circ}C^{(5)}$		2400		
Minimum off time	$T_{MIN-OFF}$			60		ns
Minimum on time <sup>(5)</sup>	$T_{MIN-ON}$			60		ns
Soft-start time	$T_{SS-ON}$	$V_{OUT}$ rise from 10% to 90%		0.5		ms
Under-voltage lockout threshold rising				2	2.25	V
Under-voltage lockout threshold hysteresis				150		mV
EN input logic low voltage					0.4	V
EN input logic high voltage			1.2			V
Output discharge resistor	$R_{DIS}$	$V_{EN} = 0V$ , $V_{OUT} = 1.2V$		1		k $\Omega$
EN input current		$V_{EN} = 2V$		1.2		$\mu A$
		$V_{EN} = 0V$		0		$\mu A$
Supply current (shutdown)		$V_{EN} = 0V$ , $T_J = 25^{\circ}C$		0	1	$\mu A$
Supply current (quiescent)		$V_{EN} = 2V$ , $V_{FB} = 0.63V$ , $V_{IN} = 3.6V$ , $5V$ , $T_J = 25^{\circ}C$		0.5		mA
Thermal shutdown <sup>(6)</sup>				160		$^{\circ}C$
Thermal hysteresis <sup>(6)</sup>				30		$^{\circ}C$

**NOTES:**

5) Guaranteed by characterization.

6) Guaranteed by design.

## TYPICAL PERFORMANCE CHARACTERISTICS

$V_{IN} = 5V$ ,  $V_{OUT} = 1.2V$ ,  $L = 1.0\mu H$ ,  $C_{OUT} = 10\mu F$ ,  $T_A = +25^\circ C$ , unless otherwise noted.

### Efficiency vs. $I_{OUT}$

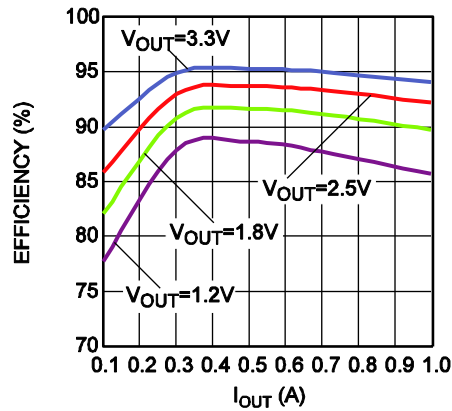

### Efficiency vs. $I_{OUT}$

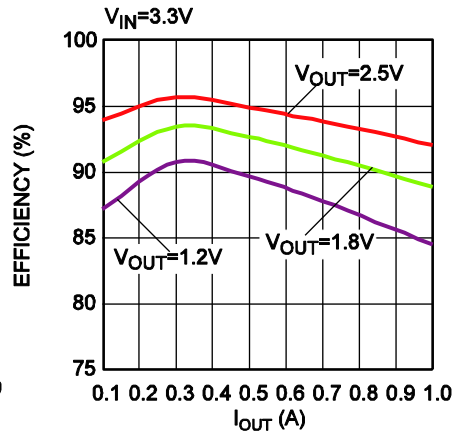

### Load Regulation vs. $I_{OUT}$

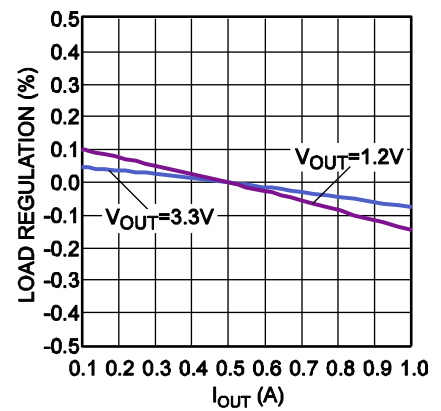

### Line Regulation vs. $I_{OUT}$

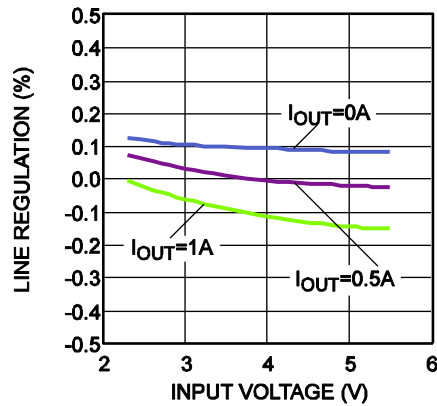

### Case Temperature Rise

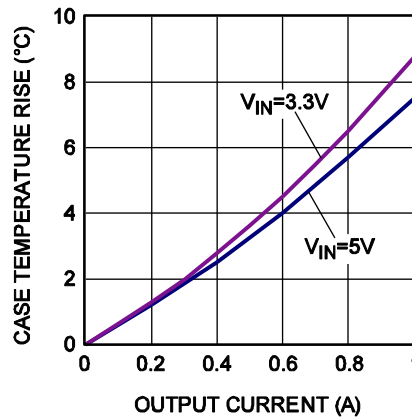

### Quiescent Current vs. Input Voltage

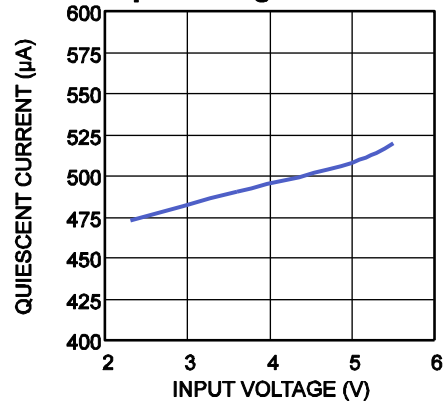

### Quiescent Current vs. Temperature

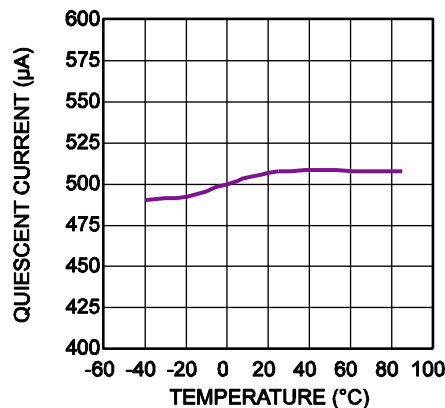

### $V_{IN}$ UVLO Rising and Falling Threshold vs. Temperature

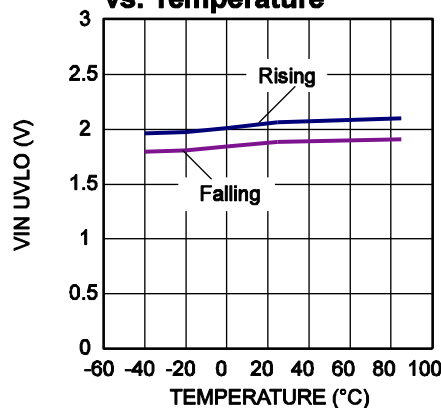

### EN Rising and Falling Threshold vs. Temperature

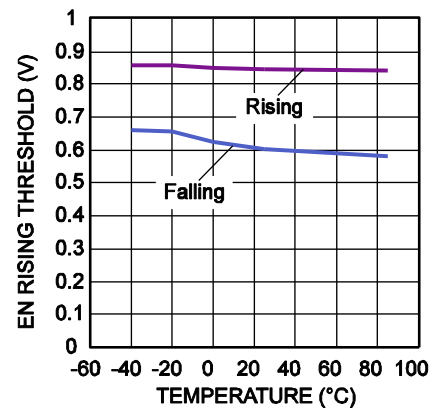

**TYPICAL PERFORMANCE CHARACTERISTICS (CONTINUED)**
 $V_{IN} = 5V$ ,  $V_{OUT} = 1.2V$ ,  $L = 1.0\mu H$ ,  $C_{OUT} = 10\mu F$ ,  $T_A = +25^\circ C$ , unless otherwise noted.

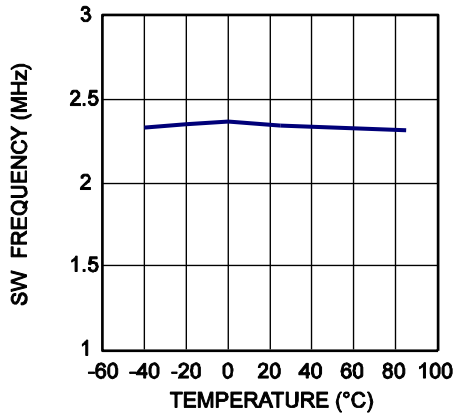
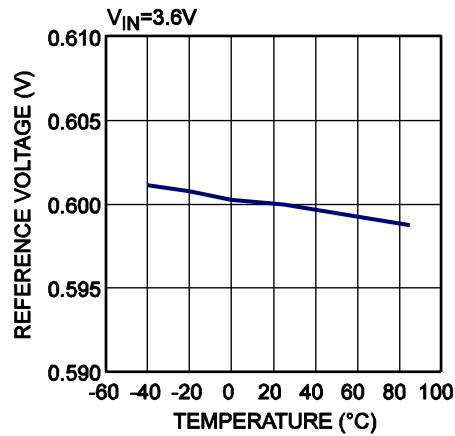
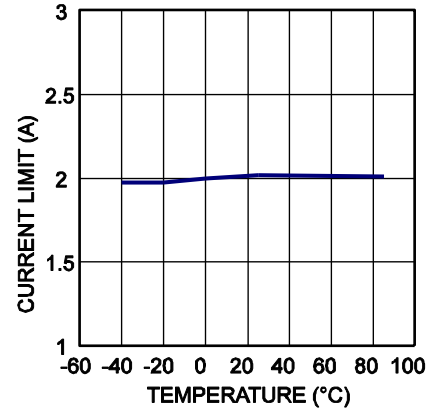
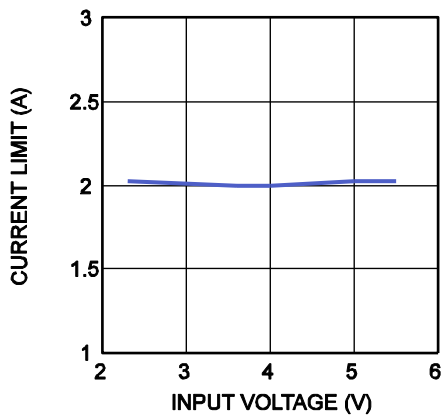
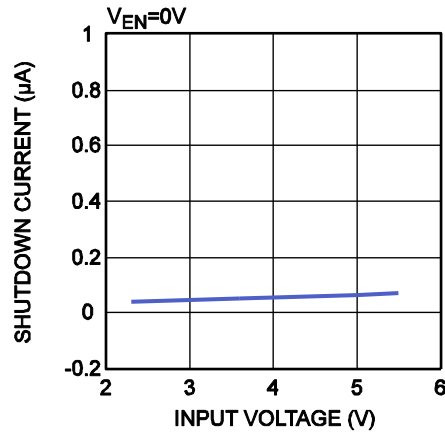
**Switching Frequency vs. Temperature**

**Reference Voltage vs. Temperature**

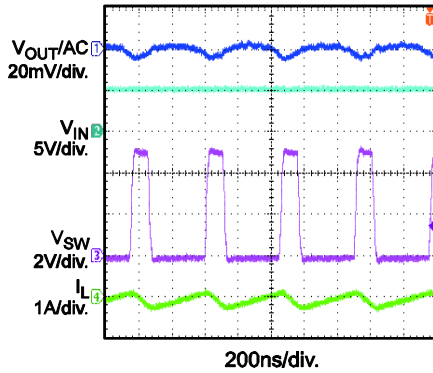
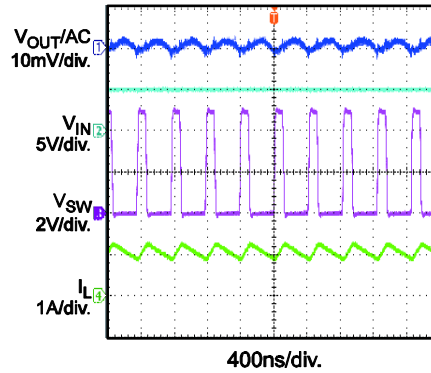
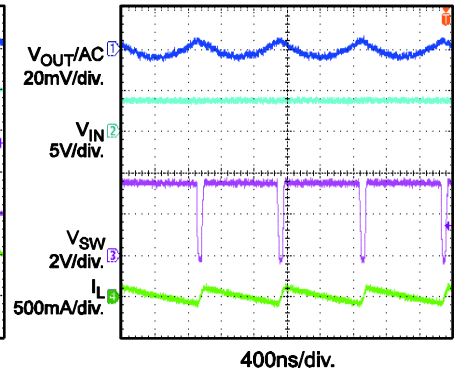
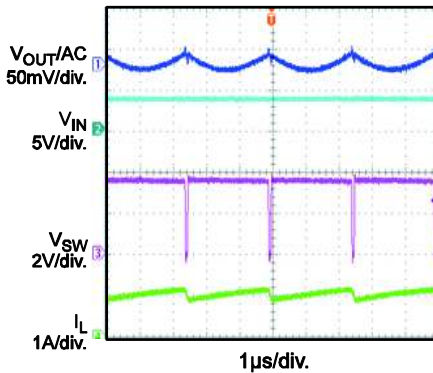
**Current limit vs. Temperature**

**Current Limit vs. Input Voltage**

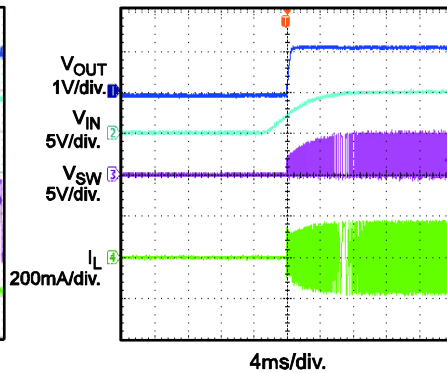
**Shutdown Current vs. Input Voltage**

**TYPICAL PERFORMANCE CHARACTERISTICS (CONTINUED)**
 $V_{IN} = 5V$ ,  $V_{OUT} = 1.2V$ ,  $L = 1.0\mu H$ ,  $C_{OUT} = 10\mu F$ ,  $T_A = +25^\circ C$ , unless otherwise noted.

**Steady State**  
without Load

**Steady State**  
with 1A Load

**Steady State**  
 $V_{IN}=3.6V$ ,  $V_{OUT}=3.3V$ , without Load

**Steady State**
 $V_{IN}=3.6V$ ,  $V_{OUT}=3.3V$ ,  $I_{OUT}=1A$ 

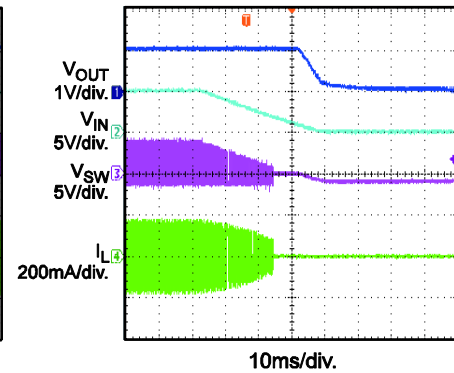
**V<sub>IN</sub> Power-Up**

without Load

**V<sub>IN</sub> Shutdown**

without Load

**V<sub>IN</sub> Power-Up**

with 1A Load

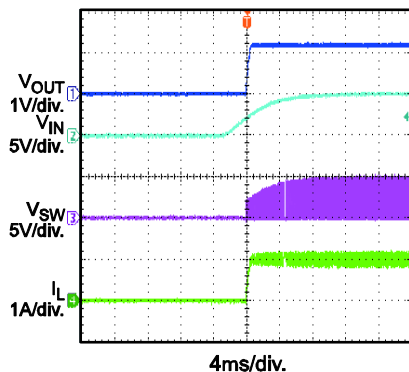
**V<sub>IN</sub> Shutdown**

with 1A Load

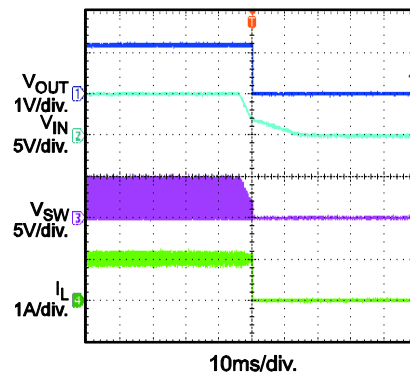
**EN Start-Up**

without Load

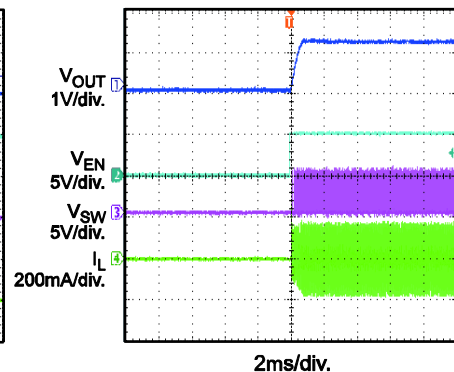

**TYPICAL PERFORMANCE CHARACTERISTICS (CONTINUED)**
 $V_{IN} = 5V$ ,  $V_{OUT} = 1.2V$ ,  $L = 1.0\mu H$ ,  $C_{OUT} = 10\mu F$ ,  $T_A = +25^\circ C$ , unless otherwise noted.

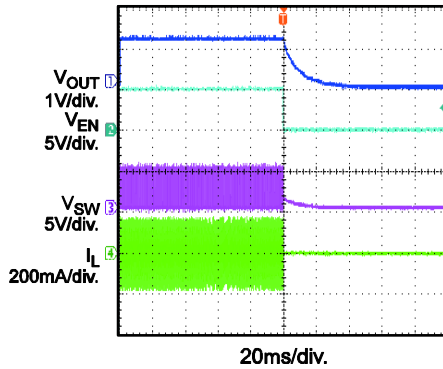
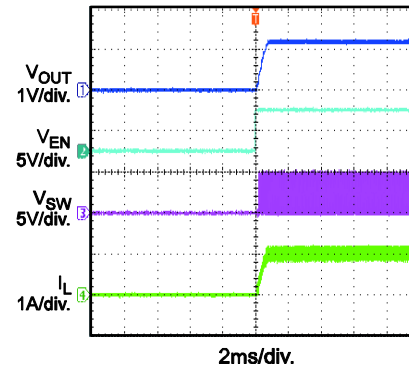
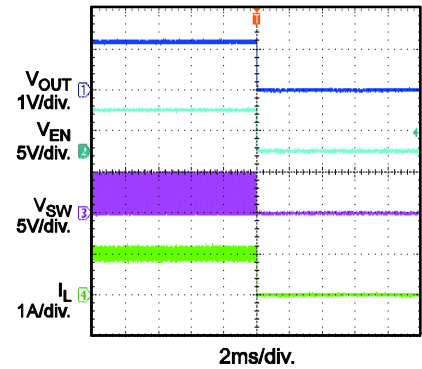
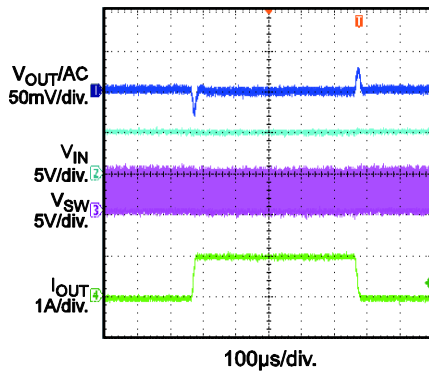
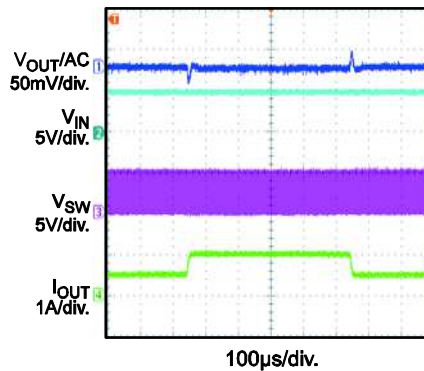
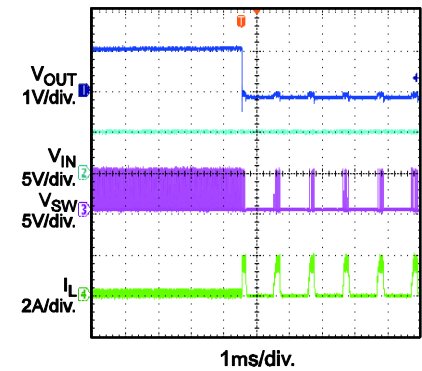
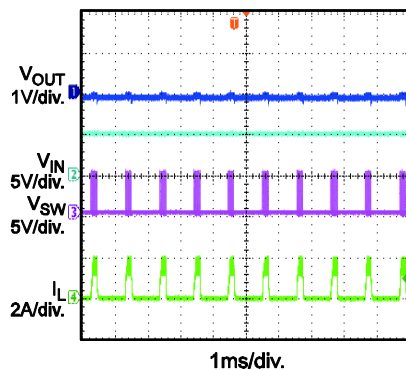
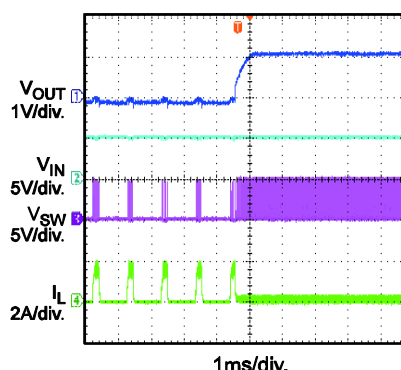
**EN Shutdown**  
without Load

**EN Start-Up**  
with 1A Load

**EN Shutdown**  
with 1A Load

**Load Transient Response**  
 $I_{OUT} = 0A - 1A$ 

**Load Transient Response**  
 $I_{OUT} = 0.5A$  to 1A

**Short-Circuit Entry**

**Short Circuit**

**Short-Circuit Recovery**

## PIN FUNCTIONS

Pin #	Name	Description
1	FB	<b>Feedback.</b> An external resistor divider from the output to GND tapped to FB sets the output voltage.
2	GND	<b>Power ground.</b>
3	VIN	<b>Supply voltage.</b> The MP21148 operates on a +2.3V to +5.5V unregulated input. A decoupling capacitor is needed to prevent large voltage spikes from appearing at input.
4	SW	<b>Output switching node.</b> SW is the drain of the internal, high-side, P-channel MOSFET. Connect the inductor to SW to complete the converter.
5	EN	<b>On/off control.</b>
6	OUT	<b>Output voltage power rail and input sense.</b> Connect the load to OUT. An output capacitor is needed to decrease the output voltage ripple.



## BLOCK DIAGRAM

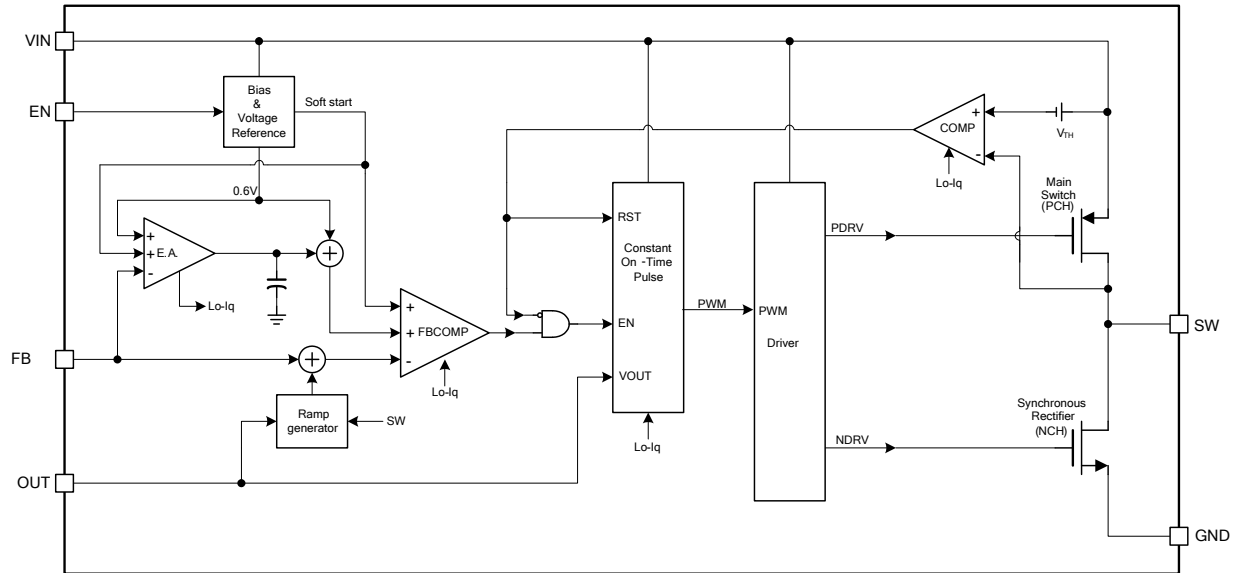

Figure 1: Functional Block Diagram

## OPERATION

The MP21148 uses constant-on-time control with an input voltage feed-forward to stabilize the switching frequency over the full input range. It achieves 1A of continuous output current from a 2.3V-to-5.5V input voltage with excellent load and line regulation. The output voltage can be regulated as low as 0.6V.

### Constant-on-Time Control

Compared to fixed-frequency PWM control, constant-on-time control offers a simpler control loop and a faster transient response. By using an input voltage feed forward, the MP21148 maintains a nearly constant switching frequency across the input and output voltage ranges. The switching pulse on time can be estimated with Equation (1):

$$T_{ON} = \frac{V_{OUT}}{V_{IN}} \cdot 0.417\mu\text{s} \quad (1)$$

To prevent inductor current runaway during the load transient, the MP21148 uses a fixed minimum off time of 60ns.

### Enable (EN)

When the input voltage is greater than the under-voltage lockout (UVLO) threshold (typically 2V) the MP21148 can be enabled by pulling EN higher than 1.2V. Leave EN floating or pull EN down to ground to disable the MP21148. There is an internal 1M $\Omega$  resistor from EN to ground.

When the device is disabled, the MP21148 goes into output discharge mode automatically. Its internal discharge MOSFET provides a resistive discharge path for the output capacitor.

### Soft Start (SS)

The MP21148 has a built-in soft start that ramps up the output voltage at a controlled slew rate to avoid overshooting at start-up. The soft start time is about 0.5ms, typically.

### Current Limit

The MP21148 has a 2A high-side switch current limit. When the high-side switch reaches its current limit, the MP21148 remains in hiccup mode until the current drops. This prevents the inductor current from continuing to rise and damaging components.

### Short Circuit and Recovery

The MP21148 also enters short-circuit protection mode when it reaches the current limit and attempts to recover with hiccup mode. In this process, the MP21148 disables the output power stage, discharges the soft-start capacitor and attempts to soft start again automatically. If the short-circuit condition remains after the soft start ends, the MP21148 repeats this cycle until the short circuit disappears and the output rises back to regulation levels.

## APPLICATION INFORMATION

### Setting the Output Voltage

The external resistor divider sets the output voltage (see the Typical Application Circuit on page 15). Select the feedback resistor (R1), typically between 100kΩ to 200kΩ, to reduce the  $V_{OUT}$  leakage current. There is no strict requirement on the feedback resistor. An R1 with a value greater than 10kΩ is recommended for most applications. R2 can then be calculated with Equation (2):

$$R2 = \frac{R1}{\frac{V_{out}}{0.6} - 1} \quad (2)$$

Figure 2 shows the feedback circuit.

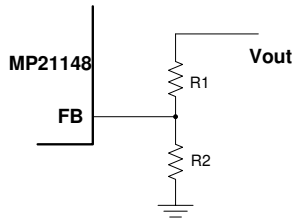

**Figure 2: Feedback Network**

Table 1 lists the recommended resistor values for common output voltages.

**Table 1: Resistor Values for Common Output Voltages**

$V_{OUT}$ (V)	R1 (kΩ)	R2 (kΩ)
1.0	200 (1%)	300 (1%)
1.2	200 (1%)	200 (1%)
1.8	200 (1%)	100 (1%)
2.5	200 (1%)	63.2 (1%)
3.3	200 (1%)	44.2 (1%)

### Selecting the Inductor

Most applications work best with a 0.47μH-to-2.2μH inductor. Select an inductor with a DC resistance below 50mΩ to optimize efficiency.

A high-frequency switch mode power supply with a magnetic device has a strong, electronic, magnetic inference for the system. Any unshielded power inductor should be avoided. Metal alloy or multiplayer chip power inductors are ideal shielded inductors for the application of the EMI as they can decrease the influence effectively. Table 2 lists some recommended inductors.

**Table 2: Suggested Inductor List**

Manufacturer P/N	Inductance (μH)	Manufacturer
PIFE25201B-1R0MS	1.0	CYNTEC CO. LTD.
1239AS-H-1R0M	1.0	Tokyo
74438322010	1.0	Würth

For most designs, estimate the inductance value with Equation (3):

$$L_1 = \frac{V_{OUT} \times (V_{IN} - V_{OUT})}{V_{IN} \times \Delta I_L \times f_{OSC}} \quad (3)$$

Where  $\Delta I_L$  is the inductor ripple current.

Choose the inductor current to be approximately 30% of the maximum load current. The maximum inductor peak current can be calculated with Equation (4):

$$I_{L(MAX)} = I_{LOAD} + \frac{\Delta I_L}{2} \quad (4)$$

### Selecting the Input Capacitor

The input current to the step-down converter is discontinuous and therefore requires a capacitor to supply AC current to the step-down converter while maintaining the DC input voltage. For best performance, use low ESR capacitors. Ceramic capacitors with X5R or X7R dielectrics are highly recommended because of their low ESR and small temperature coefficients. For most applications, a 10μF capacitor is sufficient. Higher output voltages may require a 22μF capacitor to increase system stability.

Since the input capacitor absorbs the input switching current, it requires an adequate ripple current rating. Estimate the RMS current in the input capacitor with Equation (5):

$$I_{C1} = I_{LOAD} \times \sqrt{\frac{V_{OUT}}{V_{IN}} \times \left(1 - \frac{V_{OUT}}{V_{IN}}\right)} \quad (5)$$

The worst case occurs at  $V_{IN} = 2V_{OUT}$ , shown in Equation (6):

$$I_{C1} = \frac{I_{LOAD}}{2} \quad (6)$$

For simplification, choose an input capacitor with an RMS current rating greater than half of the maximum load current.

The input capacitor can be electrolytic, tantalum, or ceramic. When using electrolytic or tantalum capacitors, add a small, high-quality 0.1µF ceramic capacitor as close to the IC as possible. When using ceramic capacitors, ensure that they have enough capacitance to provide a sufficient charge to prevent excessive voltage ripple at the input. The input voltage ripple caused by capacitance can be estimated with Equation (7):

$$\Delta V_{IN} = \frac{I_{LOAD}}{f_s \times C1} \times \frac{V_{OUT}}{V_{IN}} \times \left(1 - \frac{V_{OUT}}{V_{IN}}\right) \quad (7)$$

### Selecting the Output Capacitor

The output capacitor (C2) stabilizes the DC output voltage. Ceramic capacitors are recommended. For best results, use low ESR capacitors to limit the output voltage ripple. The output voltage ripple can be estimated with Equation (8):

$$\Delta V_{OUT} = \frac{V_{OUT}}{f_s \times L_1} \times \left(1 - \frac{V_{OUT}}{V_{IN}}\right) \times \left(R_{ESR} + \frac{1}{8 \times f_s \times C2}\right) \quad (8)$$

Where  $L_1$  is the inductor value and  $R_{ESR}$  is the equivalent series resistance (ESR) value of the output capacitor.

When using ceramic capacitors, the capacitance dominates the impedance at the switching frequency and causes most of the output voltage ripple. For simplification, the output voltage ripple can be estimated with Equation (9):

$$\Delta V_{OUT} = \frac{V_{OUT}}{8 \times f_s^2 \times L_1 \times C2} \times \left(1 - \frac{V_{OUT}}{V_{IN}}\right) \quad (9)$$

For tantalum or electrolytic capacitors, the ESR dominates the impedance at the switching frequency. For simplification, the output ripple can be approximated with Equation (10):

$$\Delta V_{OUT} = \frac{V_{OUT}}{f_s \times L_1} \times \left(1 - \frac{V_{OUT}}{V_{IN}}\right) \times R_{ESR} \quad (10)$$

The characteristics of the output capacitor also affect the stability of the regulation system.

### PCB Layout Guidelines

Efficient PCB layout is critical for stable operation. For the high-frequency switching converter, a poor layout design can result in poor line or load regulation and stability issues. For best results, refer to Figure 3 and follow the guidelines below.

1. Place the high-current paths (GND, IN, and SW) very close to the device with short, direct, and wide traces.
2. Place the input capacitor as close to IN and GND as possible.
3. Place the external feedback resistors next to FB.
4. Keep the switching node SW short and away from the feedback network.
5. Keep the  $V_{OUT}$  sense line as short as possible or keep it away from the power inductor.

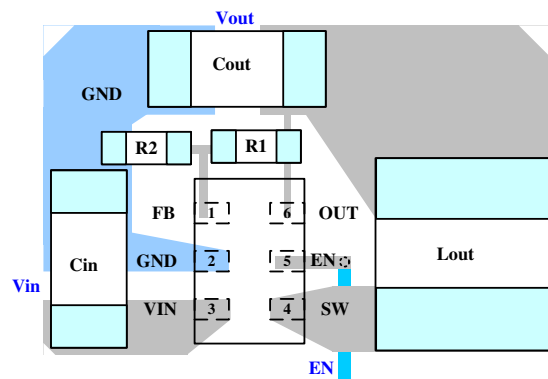

**Figure 3: Two Ends of Input Decoupling Capacitor Close to Pin 2 and Pin 3**

## TYPICAL APPLICATION CIRCUITS

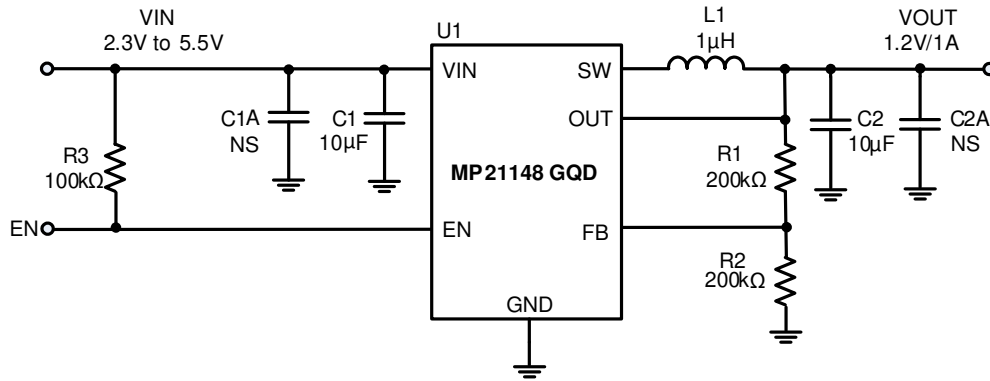
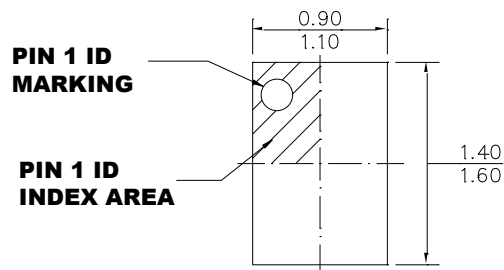

Figure 4: Typical Application Circuit

 NOTE:  $V_{IN} < 3.3V$  may require more input capacitors

## PACKAGE INFORMATION

### QFN-6 (1.0mmx1.5mm)



**TOP VIEW**

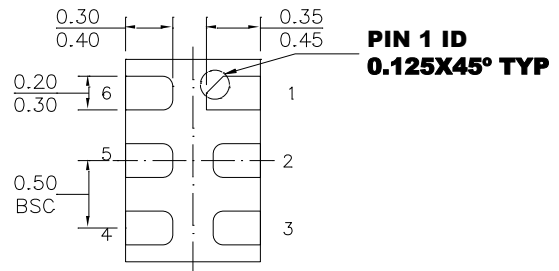

**BOTTOM VIEW**

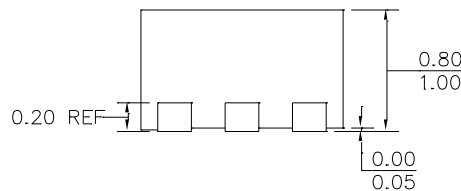

**SIDE VIEW**

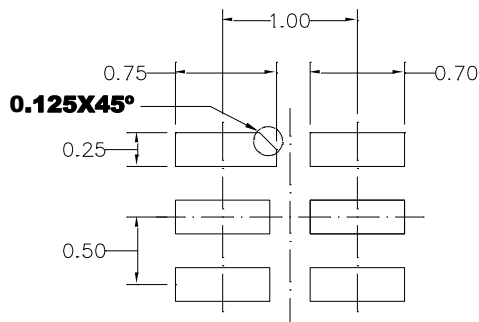

**RECOMMENDED LAND PATTERN**

### NOTE:

- 1) ALL DIMENSIONS ARE IN MILLIMETERS.
- 2) EXPOSED PADDLE SIZE DOES NOT INCLUDE MOLD FLASH.
- 3) LEAD COPLANARITY SHALL BE 0.10 MILLIMETERS MAX.
- 4) JEDEC REFERENCE IS MO-220.
- 5) DRAWING IS NOT TO SCALE.

**NOTICE:** The information in this document is subject to change without notice. Please contact MPS for current specifications. Users should warrant and guarantee that third party Intellectual Property rights are not infringed upon when integrating MPS products into any application. MPS will not assume any legal responsibility for any said applications.