

2 Attaching to a TV Wall Mount

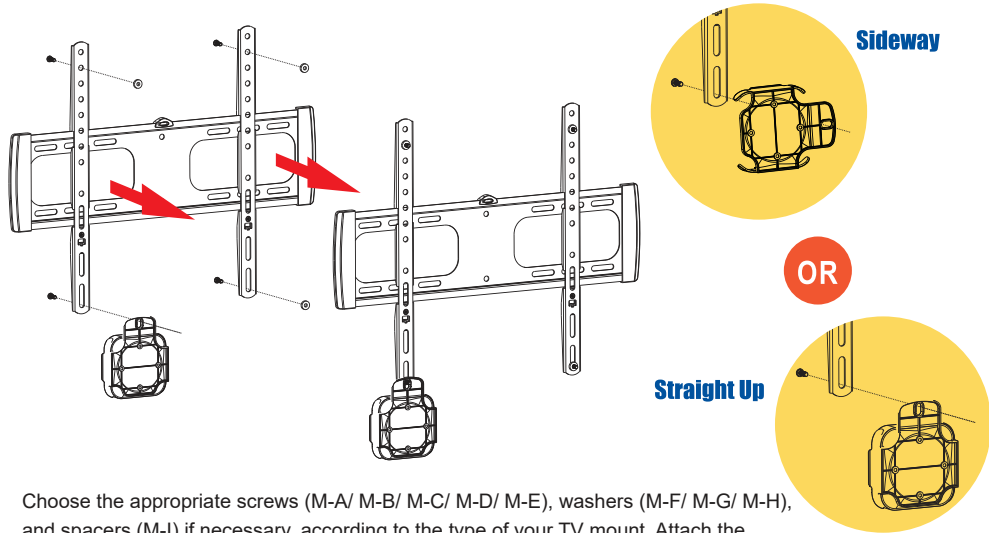

Choose the appropriate screws (M-A/ M-B/ M-C/ M-D/ M-E), washers (M-F/ M-G/ M-H), and spacers (M-I) if necessary, according to the type of your TV mount. Attach the Apple TV Wall Mount to the TV Wall Mount using a Phillips screwdriver.

3 Snapping the Apple TV onto the Mount

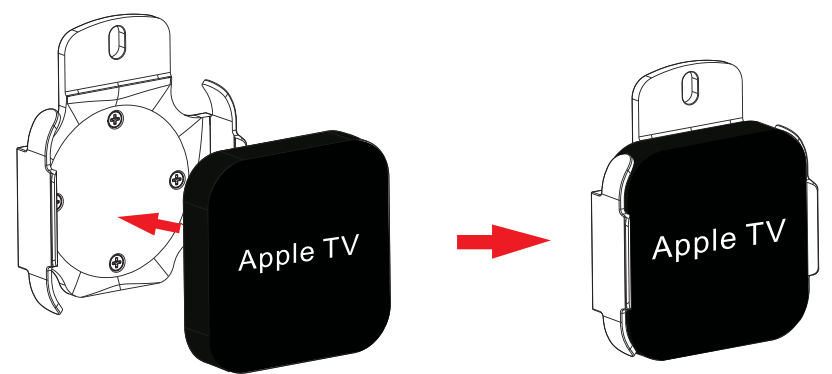

Maintenance

Please check that the mount is secure and safe to use at regular intervals. If you have any questions regarding any of the instructions or warnings, please contact your local distributor (OR) contact QualGear technical support via email at support@qualgear.com.

APPLE TV MOUNTING KIT













www.qualgear.com

■ 1 Year Limited Warranty

■ Version August 2015

! **IMPORTANT!** Please read the entire installation manual and check that all parts are included before you start installation and assembly.

Hardware Package

 M3x14mm (x1) M-A	 M4x14mm (x1) M-B	 M5x14mm (x1) M-C	 M6x14mm (x1) M-D	 M8x20mm (x1) M-E	 ST3.5x25mm Screw (x4) W-A
 D3 Washer (x1) M-F	 D5 Washer (x1) M-G	 D8 Washer (x1) M-H	 3mm Small Spacer (x3) M-I	 Φ6x28mm Concrete Anchor (x4) W-B	

Two Installation Options

Mount to a wall surface

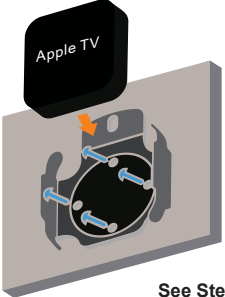

See Step 1a or 1b

Attach to a TV wall mount

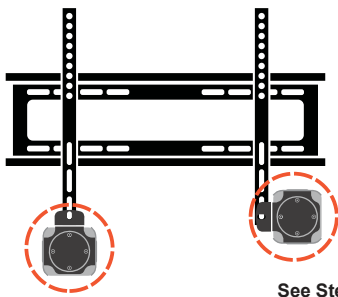

See Step 2

1a Mounting to a Wooden Stud Wall



NOTE For concrete or brick wall mounting, see Step 1b. To attach to a TV wall mount, see Step 2.

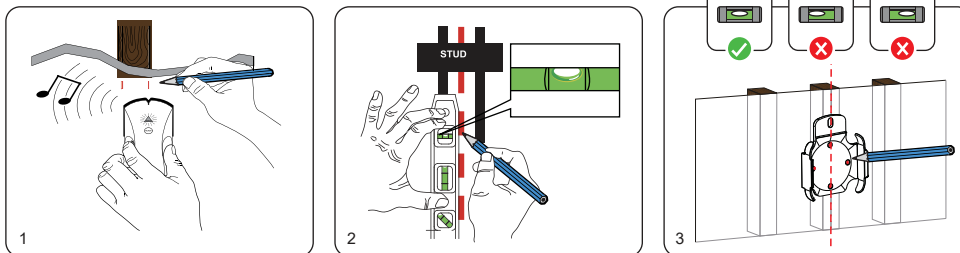

1 Using an edge-to-edge stud finder, find the edges of the stud.

2 Using a level, mark the centerline of the stud.

3 Using the wall mount as a template, mark four holes for drilling on the centerline of the stud.

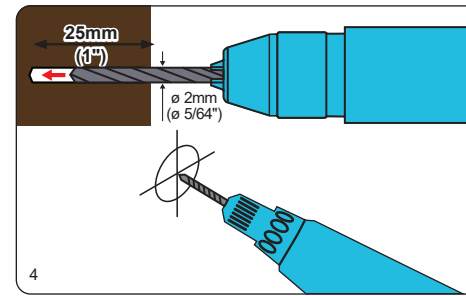

4 Using a power drill and 5/64" drill bit, drill pilot holes of 5/64" (2mm) diameter and at least 1" (25 mm) depth.

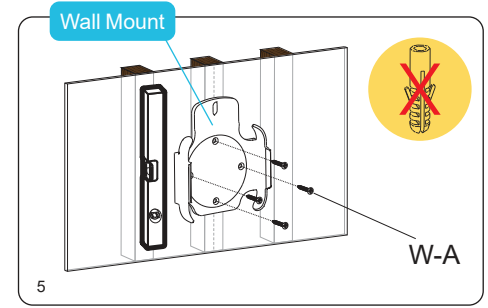

5 Using a Phillips screwdriver, mount the wall mount and fasten with the provided screws (W-A).

1b Mounting to a Concrete or a Brick Wall

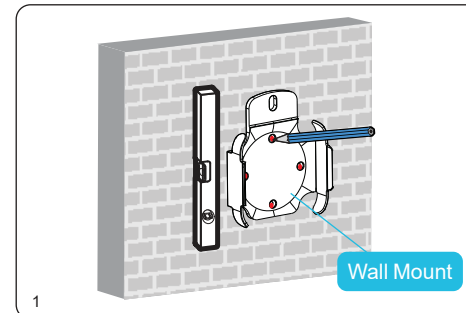
1 Use the wall mount as a template, place it against the wall where you want to install the TV.

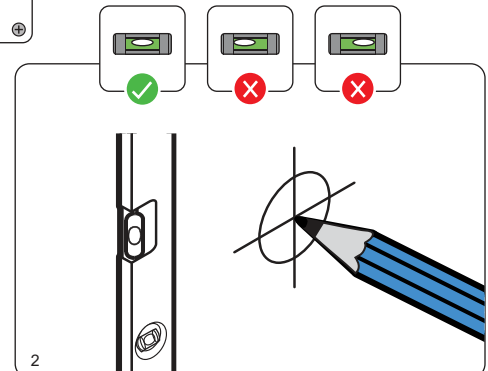

2 Level the wall mount and mark four holes for drilling.

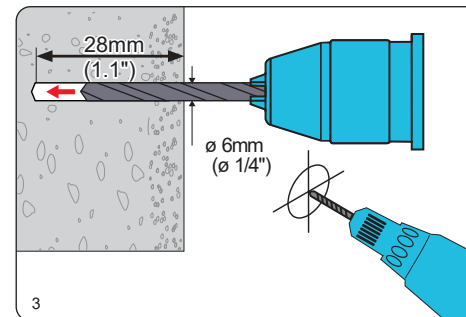

3 Using a power drill and 1/4" drill bit, drill pilot holes of 1/4" (6mm) diameter and at least 1.1" (28 mm) depth.

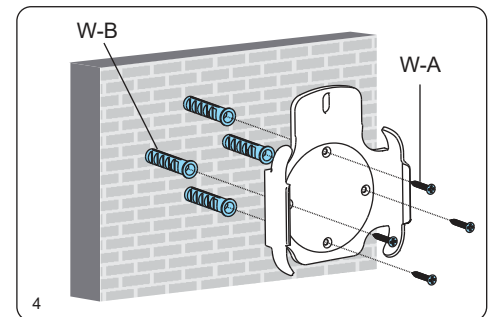

4 Place concrete anchors (W-B) in each hole. Tap each anchor flush with the wall using a hammer. Mount the wall mount and fasten screws (W-A) using a Phillips screwdriver.