

# HC-B 16-A-UT-PEL-F - Terminal adapter



1648042

<https://www.phoenixcontact.com/us/products/1648042>

Please be informed that the data shown in this PDF document is generated from our online catalog. Please find the complete data in the user documentation. Our general terms of use for downloads are valid.

HEAVYCON terminal adapter, socket insert, B16 series, 16-pos., for the left control cabinet panel, screw connection



## Commercial data

Item number	1648042
Packing unit	1 pc
Minimum order quantity	1 pc
Sales key	BF61
Product key	BF7ADC
Catalog page	Page 551 (C-2-2019)
GTIN	4017918969653
Weight per piece (including packing)	160.14 g
Weight per piece (excluding packing)	160.14 g
Customs tariff number	85366990
Country of origin	CN

# HC-B 16-A-UT-PEL-F - Terminal adapter



1648042

<https://www.phoenixcontact.com/us/products/1648042>

## Technical data

### Notes

General	For HEAVYCON-ADVANCE mounting flange and HEAVYCON panel mounting base of B16 type
General	Connectors may be operated only when there is no load/voltage.

### Product properties

Type	B16
Product type	Terminal adapter
Number of positions	16
Connection profile	16+PE
Contact numbering	1 - 16
Type	for the left side of the control cabinet
Series	HC-B
Screwdriver blade	0.5 x 3.5 mm

### Insulation characteristics

Overvoltage category	III
Degree of pollution	3

### Electrical properties

Rated voltage (III/3)	500 V
Rated surge voltage	6 kV
Rated current	16 A
SCCR	5 kA (UL 2237)

### Connection data

#### Connection technology

Connection technology	Screw connection
Connection in acc. with standard	IEC / EN

#### Conductor connection

Conductor cross section	0.5 mm <sup>2</sup> ... 2.5 mm <sup>2</sup>
Connection cross section AWG	20 ... 14
Tightening torque	0.5 Nm ... 0.8 Nm
Stripping length of the individual wire	12 mm

### Dimensions

# HC-B 16-A-UT-PEL-F - Terminal adapter



1648042

<https://www.phoenixcontact.com/us/products/1648042>

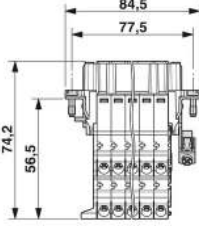
Dimensional drawing	
Width	34 mm
Height	74.2 mm
Length	84.5 mm
Drill hole distance, horizontal	77.5 mm
Drill hole distance, vertical	27 mm

## Material specifications

Flammability rating according to UL 94	V0
Contact material	Copper alloy
Contact surface material	Ag
Contact carrier material	PA
Standards/regulations	PA: Fire protection in rail vehicles - requirement sets R22, R23, and R24 acc. to DIN EN 45545-2 (Risk level HL1 - HL3)

## Cable/line

Stripping length of the individual wire	12 mm
---	-------

## Mechanical properties

### Mechanical data

Insertion/withdrawal cycles	≥ 500
-----------------------------	-------

## Environmental and real-life conditions

### Ambient conditions

Ambient temperature (operation)	-40 °C ... 125 °C
---------------------------------	-------------------

## Standards and regulations

Constructional and testing regulations	DIN EN 61984
	DIN EN 60664
	IEC 60352
Tests	DIN EN 61984
	DIN EN 60664
	IEC 60352

### Testing

Standards/regulations	PA: Fire protection in rail vehicles - requirement sets R22, R23, and R24 acc. to DIN EN 45545-2 (Risk level HL1 - HL3)
-----------------------	---

# HC-B 16-A-UT-PEL-F - Terminal adapter



1648042

<https://www.phoenixcontact.com/us/products/1648042>

## Mounting

Assembly instructions

To ensure correct use, installation in housing with IP54 protection or better is required

Connectors may only be actuated when there is no load/voltage.

# HC-B 16-A-UT-PEL-F - Terminal adapter





1648042

<https://www.phoenixcontact.com/us/products/1648042>

## Approvals

To download certificates, visit the product detail page: <https://www.phoenixcontact.com/us/products/1648042>

 **CSA**  
Approval ID: 013631\_6233\_01

 **cUL Recognized**  
Approval ID: FILE E 118976

 **UL Recognized**  
Approval ID: FILE E 118976

 **EAC**  
Approval ID: RU C-DE.AI30.B.01102

 **EAC**  
Approval ID: RU C-DE.AI30.B.01102

 **cULus Recognized**  
Approval ID: E468743

	Nominal voltage $U_N$	Nominal current $I_N$	Cross section AWG	Cross section $\text{mm}^2$
	600 V	14 A	- 14	-

 **UL Recognized**  
Approval ID: FILE E 118976

 **CSA**  
Approval ID: 013631\_6233\_01

 **cUL Recognized**  
Approval ID: FILE E 118976

 **EAC**  
Approval ID: RU C-DE.BL08.B.00511

# HC-B 16-A-UT-PEL-F - Terminal adapter



1648042

<https://www.phoenixcontact.com/us/products/1648042>

## Classifications

### ECLASS

ECLASS-11.0	27440222
ECLASS-12.0	27440222
ECLASS-13.0	27440222

### ETIM

ETIM 8.0	EC000438
----------	----------

### UNSPSC

UNSPSC 21.0	39121500
-------------	----------

# HC-B 16-A-UT-PEL-F - Terminal adapter



1648042

<https://www.phoenixcontact.com/us/products/1648042>

## Environmental product compliance

REACH SVHC	Lead 7439-92-1
China RoHS	Environmentally Friendly Use Period = 50 years
	For information on hazardous substances, refer to the manufacturer's declaration available under "Downloads"

Phoenix Contact 2023 © - all rights reserved  
<https://www.phoenixcontact.com>

Phoenix Contact USA  
586 Fulling Mill Road  
Middletown, PA 17057, United States  
(+717) 944-1300  
[info@phoenixcon.com](mailto:info@phoenixcon.com)