

## 3.3V, 1000 Kbps RS-232 Transceivers

### FEATURES

- Meets true EIA/TIA-232-F Standards from a +3.0V to +5.5V power supply
- Interoperable with EIA/TIA - 232 and adheres to EIA/TIA - 562 down to a +2.7V power source
- 1µA Low-Power Shutdown with Receivers Active (**SP3222EU**)
- Enhanced ESD Specifications:
  - ±15kV Human Body Model
  - ±15kV IEC1000-4-2 Air Discharge
  - ±8kV IEC1000-4-2 Contact Discharge
- 1000 kbps Minimum Transmission Rate
- Ideal for Handheld, Battery Operated Applications

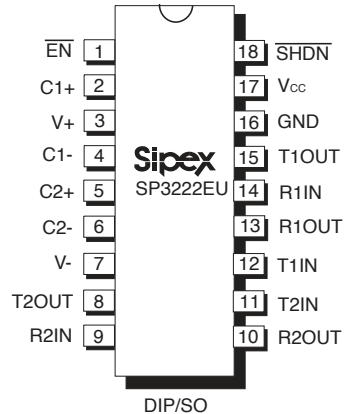

*Now Available in Lead Free Packaging*

### DESCRIPTION

The SP3222EU and the SP3232EU are 2 driver, 2 receiver RS-232 transceiver solutions intended for portable or hand-held applications such as notebook or palmtop computers. Their data transmission rate of 1000 kbps meets the demands of high speed RS-232 applications. Both ICs have a high-efficiency, charge-pump power supply that requires only 0.1µF capacitors in 3.3V operation. This charge pump allows the SP3222EU and the 3232EU to deliver true RS-232 performance from a single power supply ranging from +3.0V to +5.5V. The ESD tolerance of the SP3222EU/3232EU devices are over ±15kV for both Human Body Model and IEC1000-4-2 Air discharge test methods.

The SP3222EU device has a low-power shutdown mode where the devices' driver outputs and charge pumps are disabled. During shutdown, the supply current falls to less than 1µA.

### SELECTION TABLE

MODEL	Power Supplies	RS-232 Drivers	RS-232 Receivers	External Components	Shutdown	TTL 3-State	No. of Pins
SP3222EU	+3.0V to +5.5V	2	2	4	Yes	Yes	18, 20
SP3232EU	+3.0V to +5.5V	2	2	4	No	No	16

## ABSOLUTE MAXIMUM RATINGS

These are stress ratings only and functional operation of the device at these ratings or any other above those indicated in the operation sections of the specifications below is not implied. Exposure to absolute maximum rating conditions for extended periods of time may affect reliability and cause permanent damage to the device.

$V_{CC}$  ..... -0.3V to +6.0V  
 $V+$  (NOTE 1) ..... -0.3V to +7.0V  
 $V-$  (NOTE 1) ..... +0.3V to -7.0V  
 $V+ + V-I$  (NOTE 1) ..... +13V

$I_{CC}$  (DC  $V_{CC}$  or GND current) .....  $\pm 100$ mA

## Input Voltages

$TxIN$ ,  $EN$   $\overline{SHDN}$  ..... -0.3V to +  $V_{CC}$  +0.3V  
 $RxIN$  .....  $\pm 25$ V

## Output Voltages

$TxOUT$  .....  $\pm 13.2$ V  
 $RxOUT$  ..... -0.3V to ( $V_{CC}$  + 0.3V)

## Short-Circuit Duration

$TxOUT$  ..... Continuous

Storage Temperature ..... -65°C to +150°C

## Power Dissipation Per Package

20-pin SSOP (derate 9.25mW/°C above +70°C) ..... 750mW  
 18-pin PDIP (derate 15.2mW/°C above +70°C) ..... 1220mW  
 18-pin SOIC (derate 15.7mW/°C above +70°C) ..... 1260mW  
 20-pin TSSOP (derate 11.1mW/°C above +70°C) ..... 890mW  
 16-pin SSOP (derate 9.69mW/°C above +70°C) ..... 775mW  
 16-pin PDIP (derate 14.3mW/°C above +70°C) ..... 1150mW  
 16-pin Wide SOIC (derate 11.2mW/°C above +70°C) ..... 900mW  
 16-pin TSSOP (derate 10.5mW/°C above +70°C) ..... 850mW  
 16-pin nSOIC (derate 13.57mW/°C above +70°C) ..... 1086mW

**NOTE 1:**  $V+$  and  $V-$  can have maximum magnitudes of 7V, but their absolute difference cannot exceed 13V.

## ELECTRICAL CHARACTERISTICS

Unless otherwise noted, the following specifications apply for  $V_{CC} = +3.0$ V to +5.5V with  $T_{AMB} = T_{MIN}$  to  $T_{MAX}$ ,  $C_1$  to  $C_4 = 0.1\mu$ F

PARAMETER	MIN.	TYP.	MAX.	UNITS	CONDITIONS
DC CHARACTERISTICS					
Supply Current		0.3	1.0	mA	no load, $T_{AMB} = +25^\circ$ C, $V_{CC} = 3.3$ V, $TxIN = GND$ or $V_{CC}$
Shutdown Supply Current		1.0	10	$\mu$ A	$\overline{SHDN} = GND$ , $T_{AMB} = +25^\circ$ C, $V_{CC} = +3.3$ V, $TxIN = GND$ or $V_{CC}$
LOGIC INPUTS AND RECEIVER OUTPUTS					
Input Logic Threshold LOW	GND		0.8	V	$TxIN$ , $\overline{EN}$ , $\overline{SHDN}$ , Note 2
Input Logic Threshold HIGH	2.0 2.4		$V_{CC}$	V	$V_{CC} = 3.3$ V, Note2 $V_{CC} = 5.0$ V, Note 2
Input Leakage Current		$\pm 0.01$	$\pm 1.0$	$\mu$ A	$TxIN$ , $\overline{EN}$ , $\overline{SHDN}$ , $T_{AMB} = +25^\circ$ C, $V_{IN} = 0$ V to $V_{CC}$
Output Leakage Current		$\pm 0.05$	$\pm 10$	$\mu$ A	receivers disabled, $V_{OUT} = 0$ V to $V_{CC}$
Output Voltage LOW			0.4	V	$I_{OUT} = 1.6$ mA
Output Voltage HIGH	$V_{CC} - 0.6$	$V_{CC} - 0.1$		V	$I_{OUT} = -1.0$ mA
DRIVER OUTPUTS					
Output Voltage Swing	$\pm 5.0$	$\pm 5.4$		V	3k $\Omega$ load to ground at all driver outputs, $T_{AMB} = +25^\circ$ C
Output Resistance	300			$\Omega$	$V_{CC} = V+ = V- = 0$ V, $T_{OUT} = +2$ V
Output Short-Circuit Current		$\pm 35$	$\pm 60$	mA	$V_{OUT} = 0$ V
Output Leakage Current			$\pm 25$	$\mu$ A	$V_{OUT} = +12$ V, $V_{CC} = 0$ V to 5.5V, drivers disabled

## ELECTRICAL CHARACTERISTICS

Unless otherwise noted, the following specifications apply for  $V_{CC} = +3.0V$  to  $+5.5V$  with  $T_{AMB} = T_{MIN}$  to  $T_{MAX}$ ,  $C_1$  to  $C_4 = 0.1\mu F$ . Typical Values apply at  $V_{CC} = +3.3V$  or  $+5.5V$  and  $T_{AMB} = 25^\circ C$ .

PARAMETER	MIN.	TYP.	MAX.	UNITS	CONDITIONS
<b>RECEIVER INPUTS</b>					
Input Voltage Range	-25		+25	V	
Input Threshold LOW	0.6	1.2		V	$V_{CC}=3.3V$
	0.8	1.5		V	$V_{CC}=5.0V$
Input Threshold HIGH		1.5	2.4	V	$V_{CC}=3.3V$
		1.8	2.4	V	$V_{CC}=5.0V$
Input Hysteresis		0.3		V	
Input Resistance	3	5	7	$k\Omega$	
<b>TIMING CHARACTERISTICS</b>					
Maximum Data Rate	1000			kbps	$R_L=3k\Omega$ , $C_L=250pF$ , one driver switching
Receiver Propagation Delay		0.15		$\mu s$	$t_{PHL}$ , RxIN to RxOUT, $C_L=150pF$
		0.15		$\mu s$	$t_{PLH}$ , RxIN to RxOUT, $C_L=150pF$
Receiver Output Enable Time		200		ns	
Receiver Output Disable Time		200		ns	
Driver Skew		100		ns	$ t_{PHL} - t_{PLH} $ , $T_{AMB} = 25^\circ C$
Receiver Skew		50		ns	$ t_{PHL} - t_{PLH} $
Transition-Region Slew Rate		90		$V/\mu s$	$V_{CC} = 3.3V$ , $R_L = 3K\Omega$ , $T_{AMB} = 25^\circ C$ , measurements taken from $-3.0V$ to $+3.0V$ or $+3.0V$ to $-3.0V$

**NOTE 2:** Driver input hysteresis is typically 250mV.

## TYPICAL PERFORMANCE CHARACTERISTICS

Unless otherwise noted, the following performance characteristics apply for  $V_{CC} = +3.3V$ , 1000kbps data rates, all drivers loaded with  $3k\Omega$ ,  $0.1\mu F$  charge pump capacitors, and  $T_{AMB} = +25^{\circ}C$ .

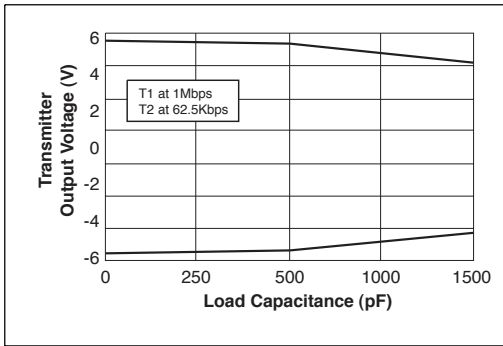

Figure 1. Transmitter Output Voltage vs Load Capacitance for the SP3222EU and the SP3232EU

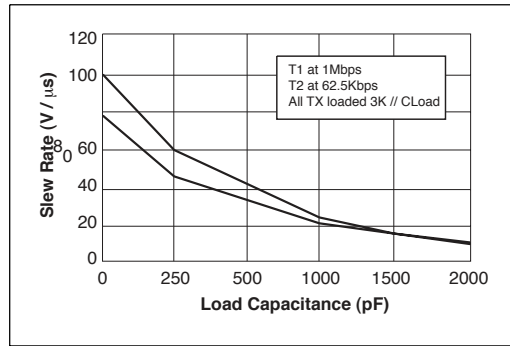

Figure 2. Slew Rate vs Load Capacitance for the SP3222EU and the SP3232EU

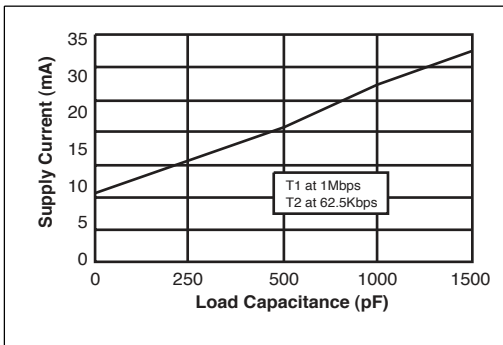

Figure 3. Supply Current vs Load Capacitance when Transmitting Data for the SP3222EU and the SP3232EU

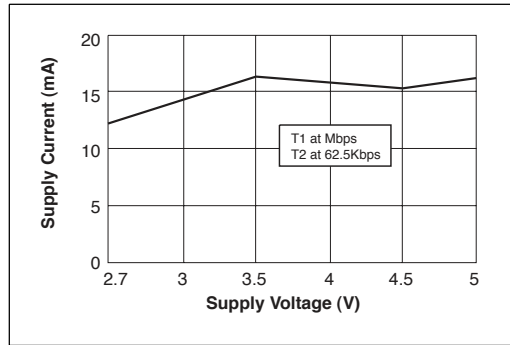

Figure 4. Supply Current vs Supply Voltage for the SP3222EU and the SP3232EU

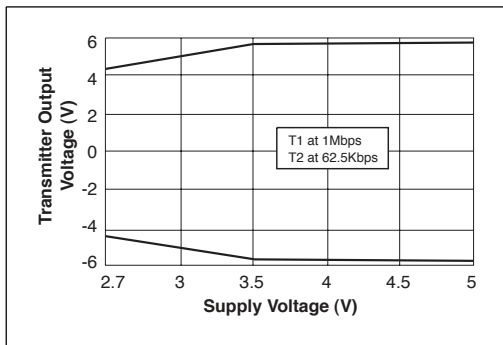

Figure 5. Transmitter Output Voltage vs Supply Voltage for the SP3222EU and the SP3232EU

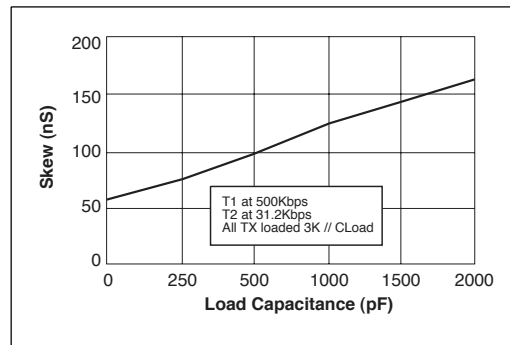

Figure 6. Transmitter Skew vs Load Capacitance for the SP3222EU and the SP3232EU

NAME	FUNCTION	PIN NUMBER		
		SP3222EU		SP3232EU
		DIP/SO	SSOP TSSOP	
$\overline{\text{EN}}$	Receiver Enable. Apply logic LOW for normal operation. Apply logic HIGH to disable the receiver outputs (high-Z state).	1	1	-
C1+	Positive terminal of the voltage doubler charge-pump capacitor.	2	2	1
V+	+5.5V generated by the charge pump.	3	3	2
C1-	Negative terminal of the voltage doubler charge-pump capacitor.	4	4	3
C2+	Positive terminal of the inverting charge-pump capacitor.	5	5	4
C2-	Negative terminal of the inverting charge-pump capacitor.	6	6	5
V-	-5.5V generated by the charge pump.	7	7	6
T1OUT	RS-232 driver output.	15	17	14
T2OUT	RS-232 driver output.	8	8	7
R1IN	RS-232 receiver input.	14	16	13
R2IN	RS-232 receiver input.	9	9	8
R1OUT	TTL/CMOS receiver output.	13	15	12
R2OUT	TTL/CMOS receiver output.	10	10	9
T1IN	TTL/CMOS driver input.	12	13	11
T2IN	TTL/CMOS driver input.	11	12	10
GND	Ground.	16	18	15
V <sub>CC</sub>	+3.0V to +5.5V supply voltage	17	19	16
$\overline{\text{SHDN}}$	Shutdown Control Input. Drive HIGH for normal device operation. Drive LOW to shutdown the drivers (high-Z output) and the on-board power supply.	18	20	-
N.C.	No Connect.	-	11, 14	-

**Table 1. Device Pin Description**

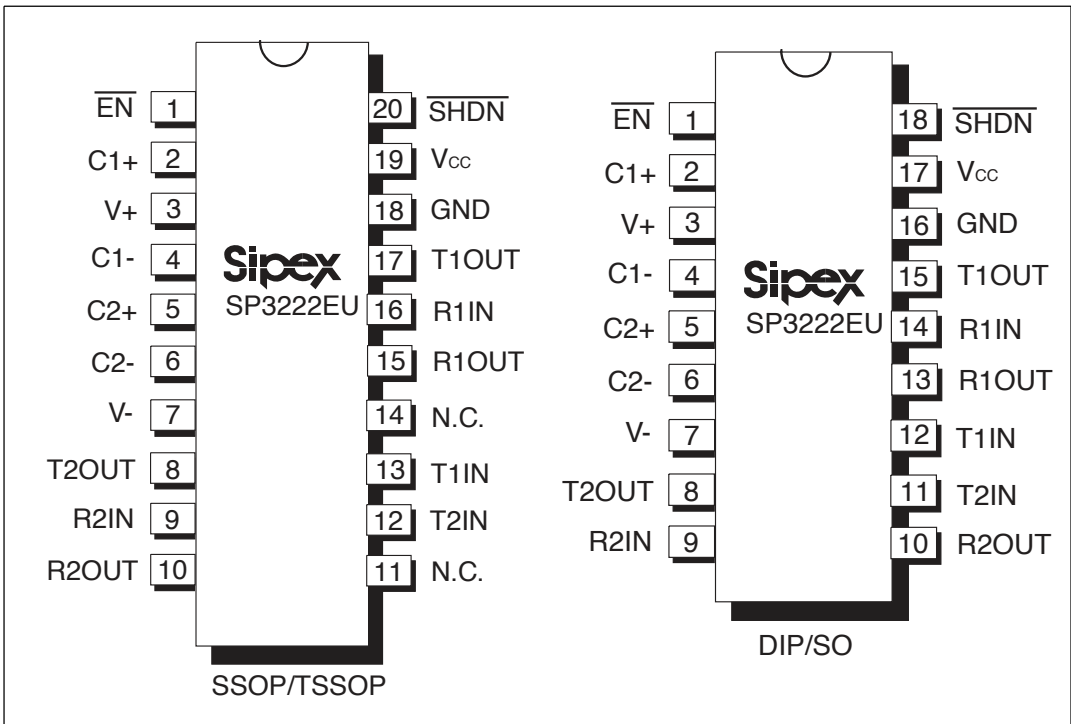

Figure 7. Pinout Configurations for the SP3222EU

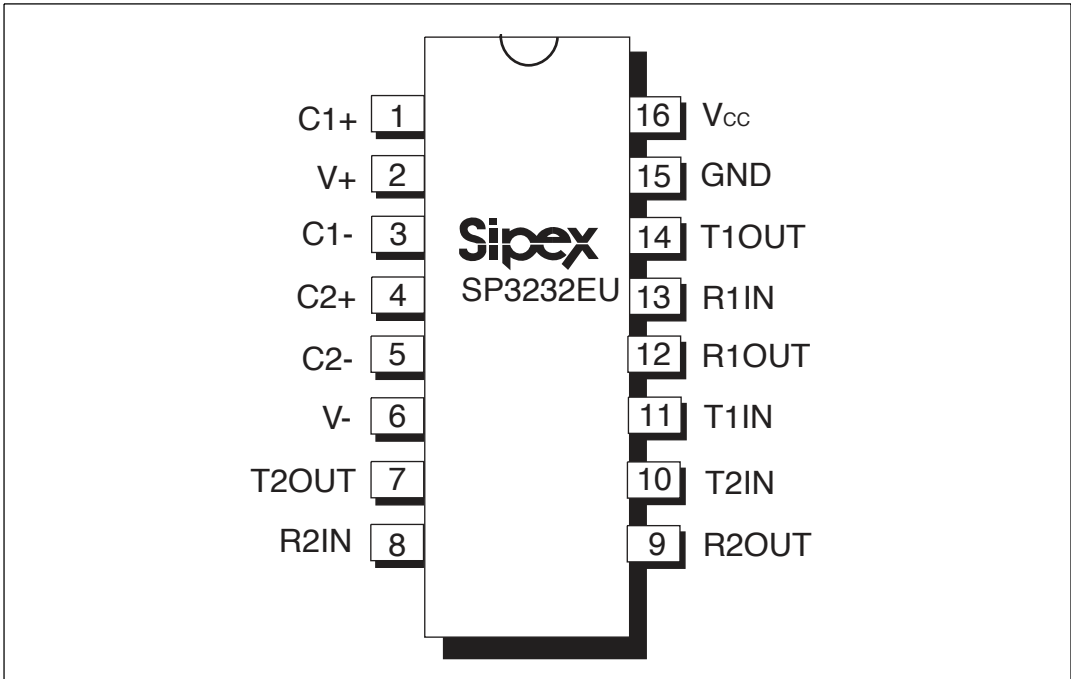

Figure 8. Pinout Configuration for the SP3232EU

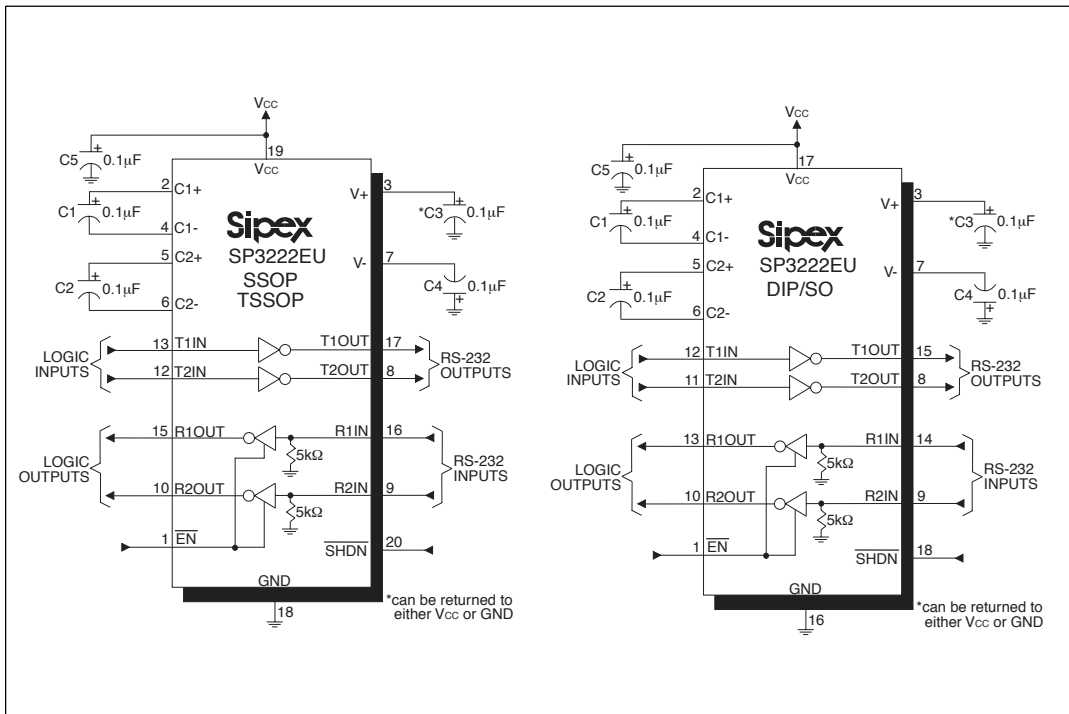

Figure 9. SP3222EU Typical Operating Circuits

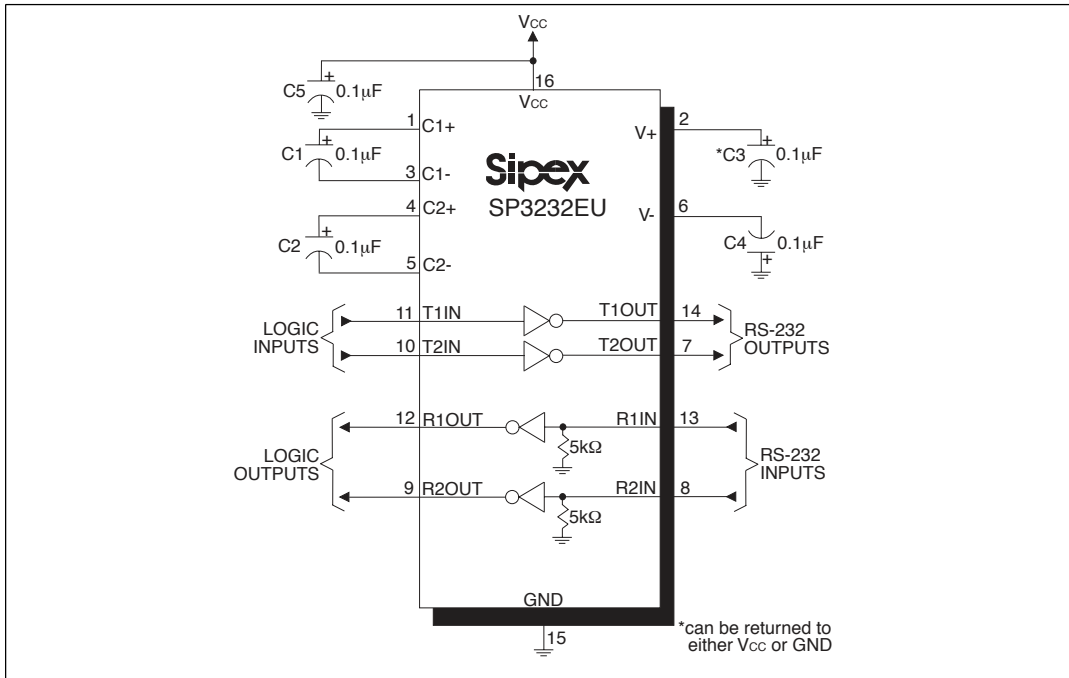

Figure 10. SP3232EU Typical Operating Circuit

## DESCRIPTION

The **SP3222EU** and **SP3232EU** are 2 driver/2 receiver devices ideal for portable or hand-held applications. The **SP3222EU** features a 1  $\mu$ A shutdown mode that reduces power consumption and extends battery life in portable systems. Its receivers remain active in shutdown mode, allowing external devices such as modems to be monitored using only 1  $\mu$ A supply current.

The **SP3222EU/3232EU** transceivers meet the EIA/TIA-232 and V.28/V.24 communication protocols. They feature **Sipex's** proprietary on-board charge pump circuitry that generates 2 x  $V_{CC}$  for RS-232 voltage levels from a single +3.0V to +5.5V power supply. The **SP3222EU/3232EU** drivers operate at a minimum data rate of 1000kbps.

## THEORY OF OPERATION

The **SP3222EU/3232EU** series are made up of three basic circuit blocks: 1. Drivers, 2. Receivers, and 3. the Sipex proprietary charge pump.

### Drivers

The drivers are inverting level transmitters that convert TTL or CMOS logic levels to  $\pm 5.0V$  EIA/TIA-232 levels inverted relative to the input logic levels. Typically, the RS-232 output voltage swing is  $\pm 5.5V$  with no load and at least  $\pm 5V$  minimum fully loaded. The driver outputs are protected against infinite short-circuits to ground without degradation in reliability. Driver outputs will meet EIA/TIA-562 levels of  $\pm 3.7V$  with supply voltages as low as 2.7V.

The drivers have a minimum data rate of 1000kbps fully loaded with 3K $\Omega$  in parallel with 250pF, ensuring compatibility with PC-to-PC communication software.

*Figure 11* shows a loopback test circuit used to the RS-232 drivers. *Figure 12* shows the test results of the loopback circuit with all drivers active at 250kbps with RS-232 loads in parallel with 1000pF capacitors. *Figure 13* shows the test results where one driver was active at 1000kbps and all drivers loaded with an RS-232 receiver in parallel with a 250pF capacitor.

The **SP3222EU** driver's output stages are tristated in shutdown mode. When the power is off, the **SP3222EU** device permits the outputs to be driven up to  $\pm 12V$ . Because the driver's inputs do not have pull-up resistors, unused inputs should be connected to  $V_{CC}$  or GND.

In the shutdown mode, the supply current is less than 1  $\mu$ A, where  $\overline{SHDN} = \text{LOW}$ . When the **SP3222EU** device is shut down, the device's driver outputs are disabled (tri-stated) and the charge pumps are turned off with  $V+$  pulled down to  $V_{CC}$  and  $V-$  pulled to GND. The time required to exit shutdown is typically 100  $\mu$ s. Connect  $\overline{SHDN}$  to  $V_{CC}$  if the shutdown mode is not used.

### Receivers

The receivers convert EIA/TIA-232 levels to TTL or CMOS logic output levels. The **SP3222EU** receivers have an inverting tri-state output. Receiver outputs (RxOUT) are tri-stated when the enable control  $\overline{EN} = \text{HIGH}$ . In the shutdown mode, the receivers can be active or inactive.  $\overline{EN}$  has no effect on TxOUT. The truth table logic of the **SP3222EU** driver and receiver outputs can be found in *Table 2*.



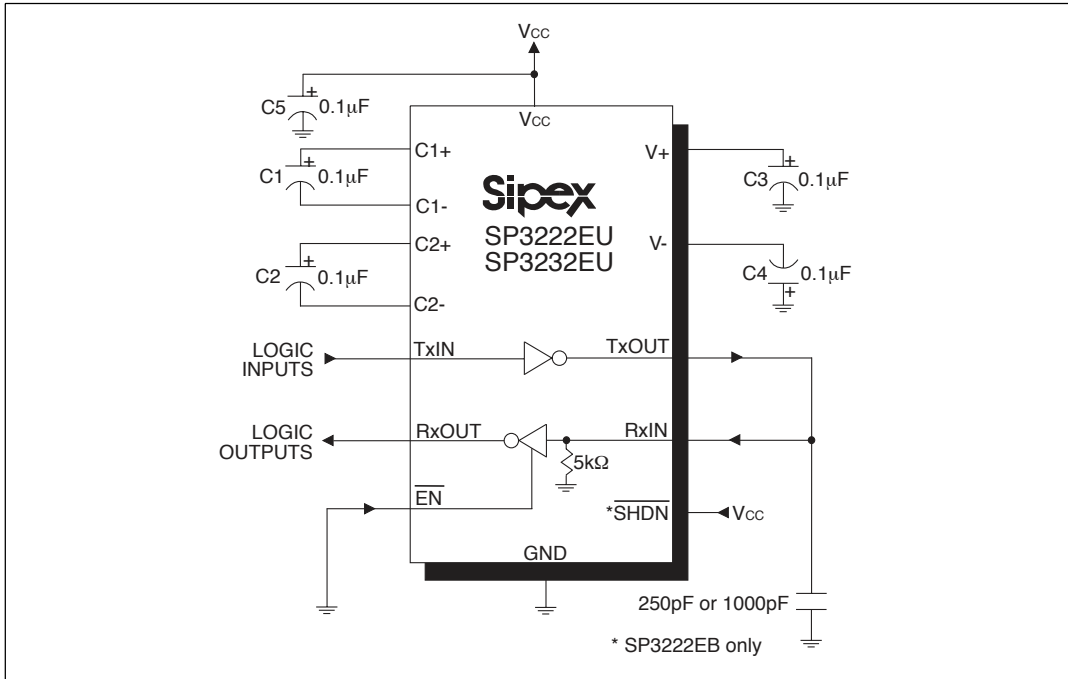

Figure 11. SP3222EU/3232EU Driver Loopback Test Circuit

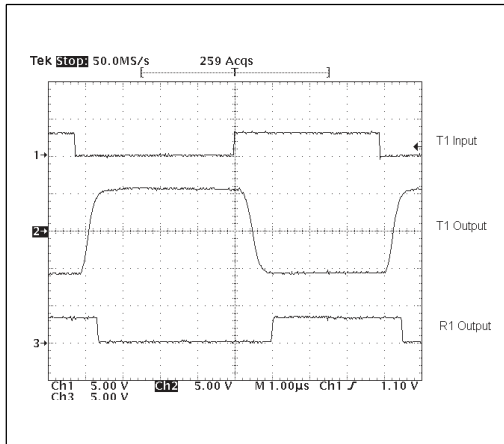

Figure 12. Driver Loopback Test All Drivers at 250kbps

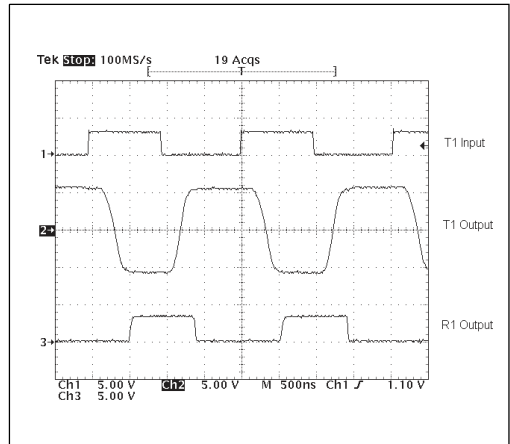

Figure 13. Driver Loopback Test One Driver 1Mbps

Since receiver input is usually from a transmission line where long cable lengths and system interference can degrade the signal and inject noise, the inputs have a typical hysteresis margin of 300mV. Should an input be left unconnected, a 5kΩ pulldown resistor to ground will commit the output of the receiver to a HIGH state.

## Charge Pump

The charge pump is a **Sipex**–patented design (5,306,954) and uses a unique approach compared to older less–efficient designs. The charge pump still requires four external capacitors, but uses a four–phase voltage shifting technique to attain symmetrical 5.5V power supplies. The internal power supply consists of a regulated dual charge pump that provides output voltages 5.5V regardless of the input voltage ( $V_{CC}$ ) over the +3.0V to +5.5V range.

In most circumstances, decoupling the power supply can be achieved adequately using a 0.1μF bypass capacitor at C5 (refer to *Figures 9 and 10*). In applications that are sensitive to power-supply noise, decouple  $V_{CC}$  to ground with a capacitor of the same value as charge-pump capacitor C1. Physically connect bypass capacitors as close to the IC as possible.

The charge pumps operate in a discontinuous mode using an internal oscillator. If the

$\overline{\text{SHDN}}$	$\overline{\text{EN}}$	TxOUT	RxOUT
0	0	Tri-state	Active
0	1	Tri-state	Tri-state
1	0	Active	Active
1	1	Active	Tri-state

*Table 2. SP3222EU Truth Table Logic for Shutdown and Enable Control*

output voltages are less than a magnitude of 5.5V, the charge pumps are enabled. If the output voltage exceed a magnitude of 5.5V, the charge pumps are disabled. This oscillator controls the four phases of the voltage shifting. A description of each phase follows.

### Phase 1

—  $V_{SS}$  charge storage — During this phase of the clock cycle, the positive side of capacitors  $C_1$  and  $C_2$  are initially charged to  $V_{CC}$ .  $C_1^+$  is then switched to GND and the charge in  $C_1^-$  is transferred to  $C_2^-$ . Since  $C_2^+$  is connected to  $V_{CC}$ , the voltage potential across capacitor  $C_2$  is now 2 times  $V_{CC}$ .

### Phase 2

—  $V_{SS}$  transfer — Phase two of the clock connects the negative terminal of  $C_2$  to the  $V_{SS}$  storage capacitor and the positive terminal of  $C_2$  to GND. This transfers a negative generated voltage to  $C_3$ . This generated voltage is regulated to a minimum voltage of -5.5V. Simultaneous with the transfer of the voltage to  $C_3$ , the positive side of capacitor  $C_1$  is switched to  $V_{CC}$  and the negative side is connected to GND.

### Phase 3

—  $V_{DD}$  charge storage — The third phase of the clock is identical to the first phase — the charge transferred in  $C_1$  produces  $-V_{CC}$  in the negative terminal of  $C_1$ , which is applied to the negative side of capacitor  $C_2$ . Since  $C_2^+$  is at  $V_{CC}$ , the voltage potential across  $C_2$  is 2 times  $V_{CC}$ .

### Phase 4

—  $V_{DD}$  transfer — The fourth phase of the clock connects the negative terminal of  $C_2$  to GND, and transfers this positive generated voltage across  $C_2$  to  $C_4$ , the  $V_{DD}$  storage capacitor. This voltage is regulated to +5.5V. At this voltage, the internal oscillator is disabled. Simultaneous with the transfer of the voltage to  $C_4$ , the positive side of capacitor  $C_1$  is switched to  $V_{CC}$  and the negative side

is connected to GND, allowing the charge pump cycle to begin again. The charge pump cycle will continue as long as the operational conditions for the internal oscillator are present.

Since both  $V^+$  and  $V^-$  are separately generated from  $V_{CC}$ ; in a no-load condition  $V^+$  and  $V^-$  will be symmetrical. Older charge pump approaches that generate  $V^-$  from  $V^+$  will show a decrease in the magnitude of  $V^-$  compared to  $V^+$  due to the inherent inefficiencies in the design.

The clock rate for the charge pump typically operates at 250kHz. The external capacitors can be as low as 0.1 $\mu$ F with a 16V breakdown voltage rating.

## ESD Tolerance

The **SP3222EU/3232EU** series incorporates ruggedized ESD cells on all driver output and receiver input pins. The ESD structure is improved over our previous family for more rugged applications and environments sensitive to electrostatic discharges and associated transients. The improved ESD tolerance is at least  $\pm 15$ kV without damage nor latch-up.

There are different methods of ESD testing applied:

- a) MIL-STD-883, Method 3015.7
- b) IEC1000-4-2 Air-Discharge
- c) IEC1000-4-2 Direct Contact

The Human Body Model has been the generally accepted ESD testing method for semiconductors. This method is also specified in MIL-STD-883, Method 3015.7 for ESD testing. The premise of this ESD test is to simulate the human body's potential to store electrostatic energy and discharge it to an integrated circuit. The simulation is performed by using a test model as shown in *Figure 20*. This method will test the IC's capability to withstand an ESD transient during normal handling such as in

manufacturing areas where the ICs tend to be handled frequently.

The IEC-1000-4-2, formerly IEC801-2, is generally used for testing ESD on equipment and systems. For system manufacturers, they must guarantee a certain amount of ESD protection since the system itself is exposed to the outside environment and human presence. The premise with IEC1000-4-2 is that the system is required to withstand an amount of static electricity when ESD is applied to points and surfaces of the equipment that are accessible to personnel during normal usage. The transceiver IC receives most of the ESD current when the ESD source is applied to the connector pins. The test circuit for IEC1000-4-2 is shown on *Figure 21*. There are two methods within IEC1000-4-2, the Air Discharge method and the Contact Discharge method.

With the Air Discharge Method, an ESD voltage is applied to the equipment under test (EUT) through air. This simulates an electrically charged person ready to connect a cable onto the rear of the system only to find an unpleasant zap just before the person touches the back panel. The high energy potential on the person discharges through an arcing path to the rear panel of the system before he or she even touches the system. This energy, whether discharged directly or through air, is predominantly a function of the discharge current rather than the discharge voltage.

Variables with an air discharge such as approach speed of the object carrying the ESD potential to the system and humidity will tend to change the discharge current. For example, the rise time of the discharge current varies with the approach speed.

The Contact Discharge Method applies the ESD current directly to the DUT.

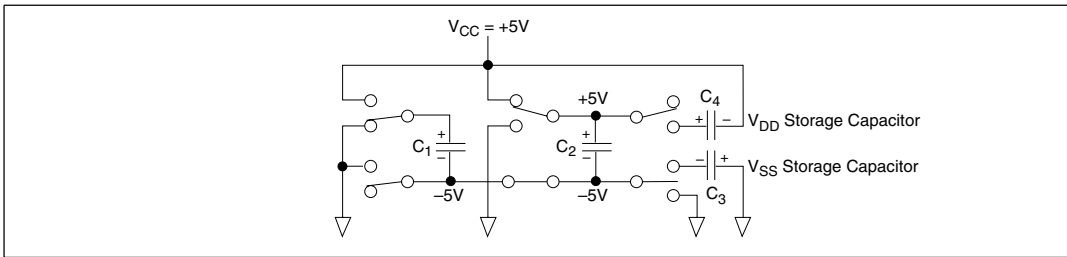

Figure 15. Charge Pump — Phase 1

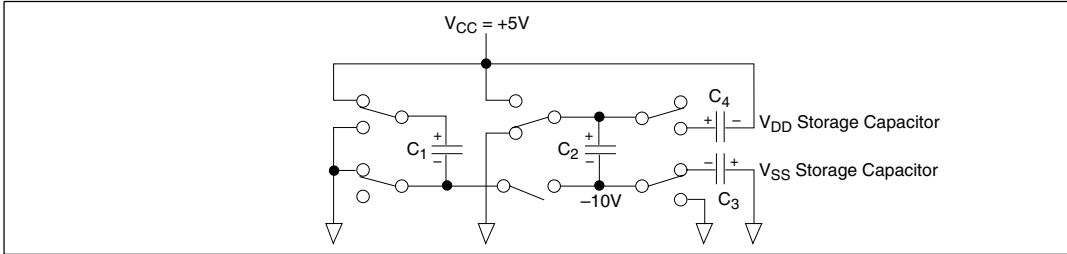

Figure 16. Charge Pump — Phase 2

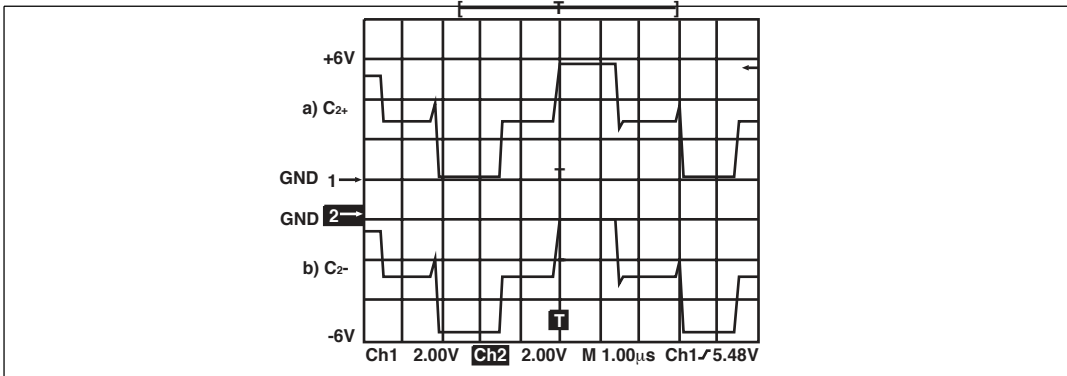

Figure 17. Charge Pump Waveforms

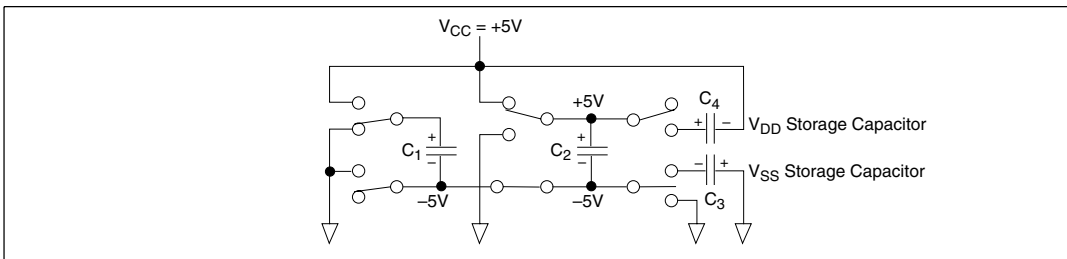

Figure 18. Charge Pump — Phase 3

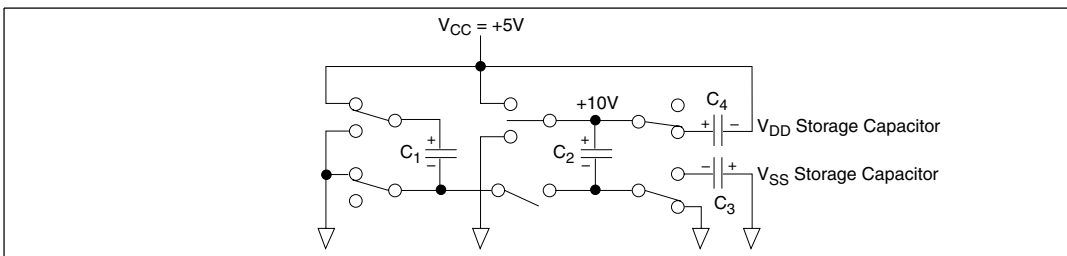
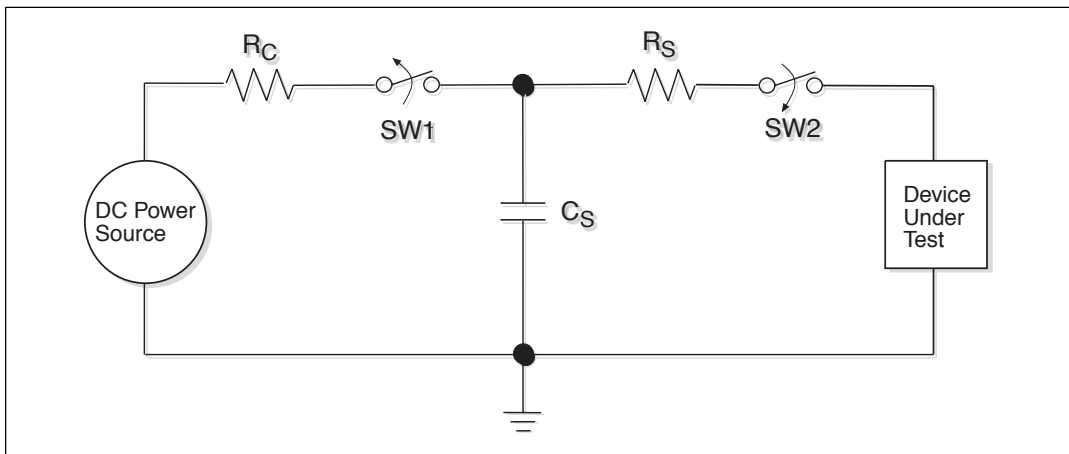

Figure 19. Charge Pump — Phase 4

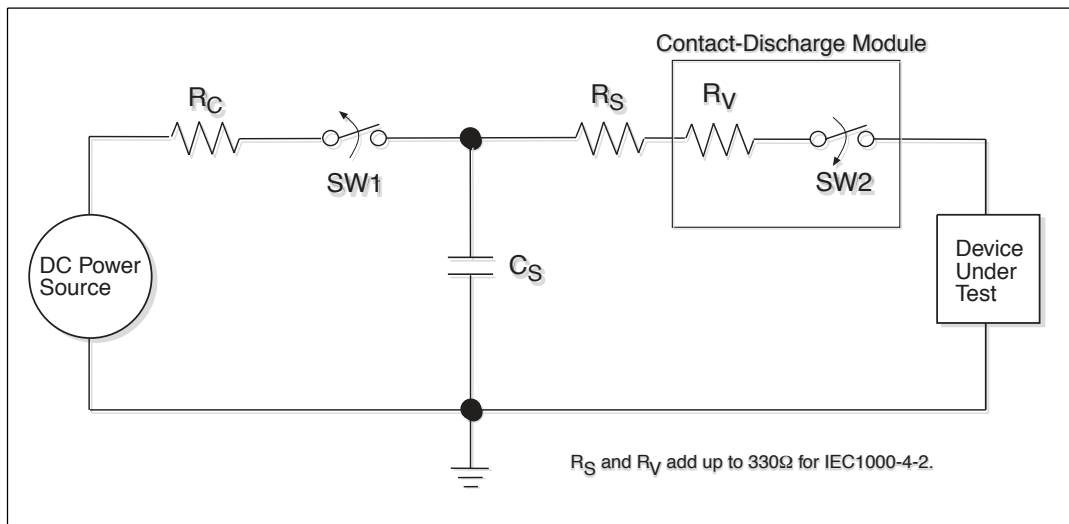

**Figure 20. ESD Test Circuit for Human Body Model**

This method was devised to reduce the unpredictability of the ESD arc. The discharge current rise time is constant since the energy is directly transferred without the air-gap arc. In situations such as hand held systems, the ESD charge can be directly discharged to the equipment from a person already holding the equipment. The current is transferred on to the keypad or the serial port of the equipment directly and then travels through the PCB and finally to the IC.

represent the typical ESD testing circuits used for all three methods. The  $C_S$  is initially charged with the DC power supply when the first switch (SW1) is on. Now that the capacitor is charged, the second switch (SW2) is on while SW1 switches off. The voltage stored in the capacitor is then applied through  $R_S$ , the current limiting resistor, onto the device under test (DUT). In ESD tests, the SW2 switch is pulsed so that the device under test receives a duration of voltage.

The circuit models in *Figures 20 and 21*



**Figure 21. ESD Test Circuit for IEC1000-4-2**

For the Human Body Model, the current limiting resistor ( $R_s$ ) and the source capacitor ( $C_s$ ) are  $1.5k\Omega$  and  $100pF$ , respectively. For IEC-1000-4-2, the current limiting resistor ( $R_s$ ) and the source capacitor ( $C_s$ ) are  $330\Omega$  and  $150pF$ , respectively.

The higher  $C_s$  value and lower  $R_s$  value in the IEC1000-4-2 model are more stringent than the Human Body Model. The larger storage capacitor injects a higher voltage to the test point when SW2 is switched on. The lower current limiting resistor increases the current charge onto the test point.

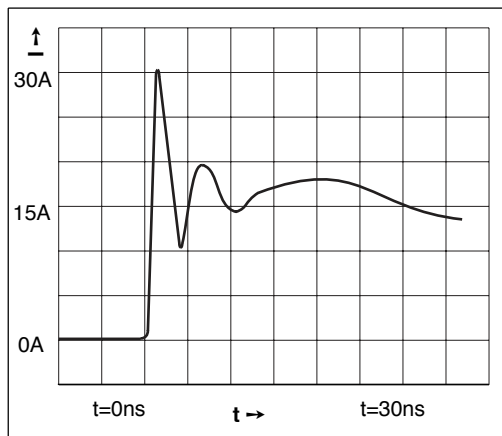
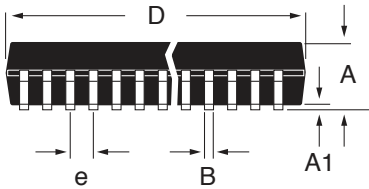
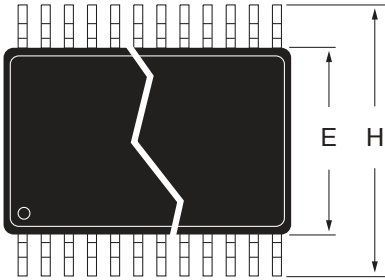

Figure 22. ESD Test Waveform for IEC1000-4-2

Device Pin Tested	Human Body Model	IEC1000-4-2		
		Air Discharge	Direct Contact	Level
Driver Outputs	$\pm 15kV$	$\pm 15kV$	$\pm 8kV$	4
Receiver Inputs	$\pm 15kV$	$\pm 15kV$	$\pm 8kV$	4

Table 3. Transceiver ESD Tolerance Levels

# PACKAGE: PLASTIC SHRINK SMALL OUTLINE (SSOP)



DIMENSIONS (Inches) Minimum/Maximum (mm)	16-PIN	20-PIN
A	0.068/0.078 (1.73/1.99)	0.068/0.078 (1.73/1.99)
A1	0.002/0.008 (0.05/0.21)	0.002/0.008 (0.05/0.21)
B	0.010/0.015 (0.25/0.38)	0.010/0.015 (0.25/0.38)
D	0.239/0.249 (6.07/6.33)	0.278/0.289 (7.07/7.33)
E	0.205/0.212 (5.20/5.38)	0.205/0.212 (5.20/5.38)
e	0.0256 BSC (0.65 BSC)	0.0256 BSC (0.65 BSC)
H	0.301/0.311 (7.65/7.90)	0.301/0.311 (7.65/7.90)
L	0.022/0.037 (0.55/0.95)	0.022/0.037 (0.55/0.95)
Ø	0°/8° (0°/8°)	0°/8° (0°/8°)

# PACKAGE: PLASTIC DUAL-IN-LINE (NARROW)

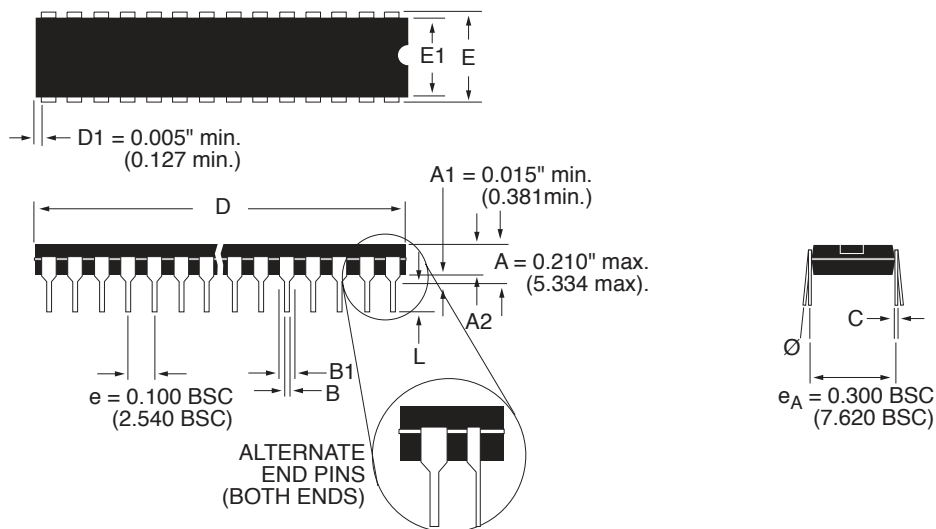

DIMENSIONS (Inches) Minimum/Maximum (mm)	16-PIN	18-PIN
<b>A2</b>	0.115/0.195 (2.921/4.953)	0.115/0.195 (2.921/4.953)
<b>B</b>	0.014/0.022 (0.356/0.559)	0.014/0.022 (0.356/0.559)
<b>B1</b>	0.045/0.070 (1.143/1.778)	0.045/0.070 (1.143/1.778)
<b>C</b>	0.008/0.014 (0.203/0.356)	0.008/0.014 (0.203/0.356)
<b>D</b>	0.780/0.800 (19.812/20.320)	0.880/0.920 (22.352/23.368)
<b>E</b>	0.300/0.325 (7.620/8.255)	0.300/0.325 (7.620/8.255)
<b>E1</b>	0.240/0.280 (6.096/7.112)	0.240/0.280 (6.096/7.112)
<b>L</b>	0.115/0.150 (2.921/3.810)	0.115/0.150 (2.921/3.810)
<b>Ø</b>	0°/ 15° (0°/15°)	0°/ 15° (0°/15°)



**PACKAGE: PLASTIC  
SMALL OUTLINE (SOIC)  
(WIDE)**

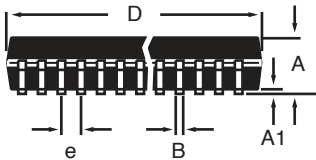
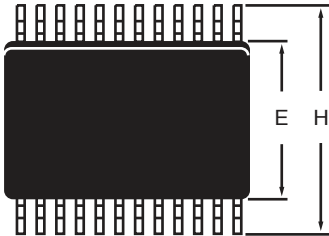

DIMENSIONS (Inches) Minimum/Maximum (mm)	16-PIN	18-PIN
A	0.090/0.104 (2.29/2.649)	0.090/0.104 (2.29/2.649)
A1	0.004/0.012 (0.102/0.300)	0.004/0.012 (0.102/0.300)
B	0.013/0.020 (0.330/0.508)	0.013/0.020 (0.330/0.508)
D	0.398/0.413 (10.10/10.49)	0.447/0.463 (11.35/11.74)
E	0.291/0.299 (7.402/7.600)	0.291/0.299 (7.402/7.600)
e	0.050 BSC (1.270 BSC)	0.050 BSC (1.270 BSC)
H	0.394/0.419 (10.00/10.64)	0.394/0.419 (10.00/10.64)
L	0.016/0.050 (0.406/1.270)	0.016/0.050 (0.406/1.270)
Ø	0°/8° (0°/8°)	0°/8° (0°/8°)

**PACKAGE: PLASTIC  
SMALL OUTLINE (SOIC)  
(NARROW)**

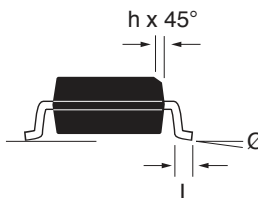
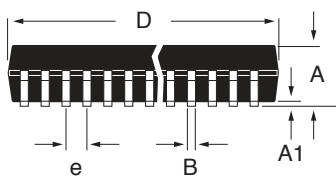
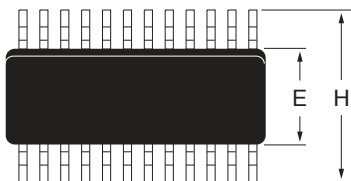

DIMENSIONS (Inches) Minimum/Maximum (mm)	16-PIN
A	0.053/0.069 (1.346/1.748)
A1	0.004/0.010 (0.102/0.249)
B	0.013/0.020 (0.330/0.508)
D	0.386/0.394 (9.802/10.000)
E	0.150/0.157 (3.802/3.988)
e	0.050 BSC (1.270 BSC)
H	0.228/0.244 (5.801/6.198)
h	0.010/0.020 (0.254/0.498)
L	0.016/0.050 (0.406/1.270)
Ø	0°/8° (0°/8°)

# PACKAGE: PLASTIC THIN SMALL OUTLINE (TSSOP)

DIMENSIONS						
in inches (mm) Minimum/Maximum						
Symbol	14 Lead	16 Lead	20 Lead	24 Lead	28 Lead	38 Lead
D	0.193/0.201 (4.90/5.10)	0.193/0.201 (4.90/5.10)	0.252/0.260 (6.40/6.60)	0.303/0.311 (7.70/7.90)	0.378/0.386 (9.60/9.80)	0.378/0.386 (9.60/9.80)
e	0.026 BSC (0.65 BSC)	0.026 BSC (0.65 BSC)	0.026 BSC (0.65 BSC)	0.026 BSC (0.65 BSC)	0.026 BSC (0.65 BSC)	0.020 BSC (0.50 BSC)

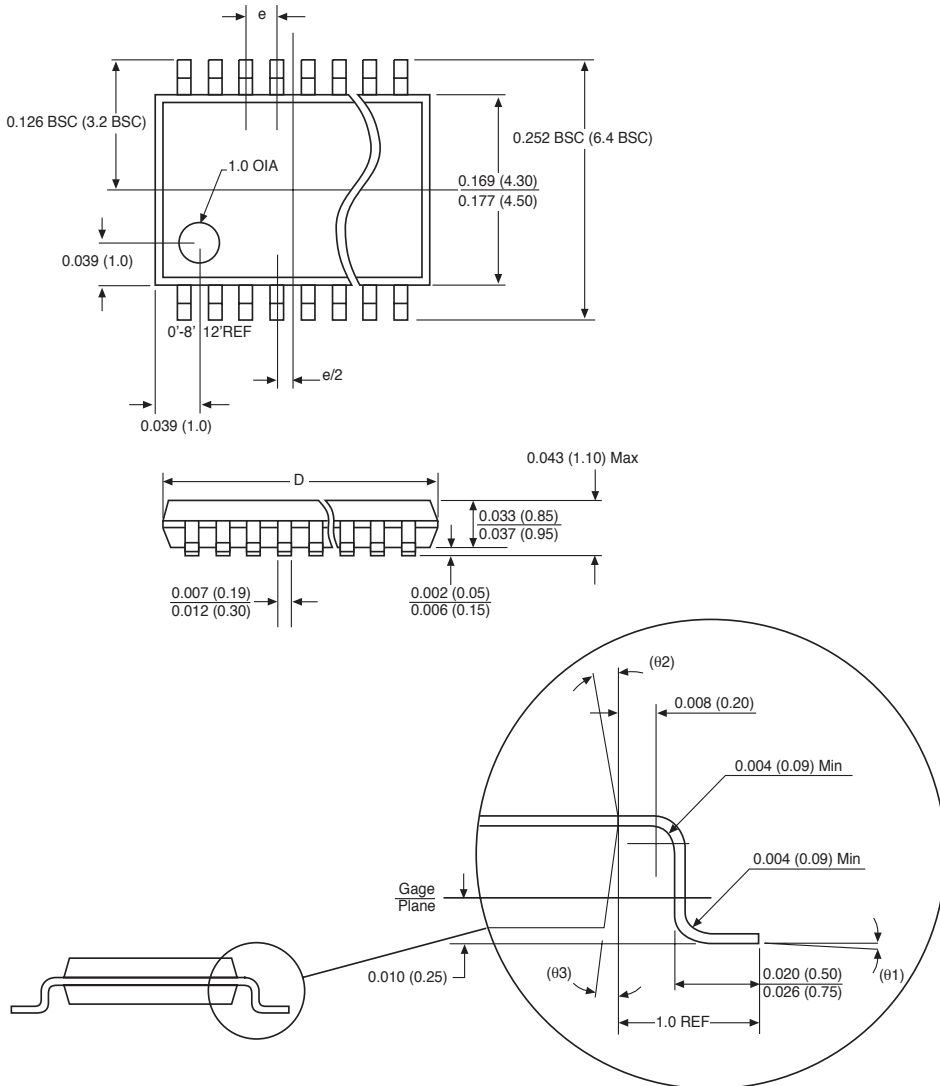

## ORDERING INFORMATION

Model	Temperature Range	Package Type
SP3222EUCA .....	0°C to +70°C .....	20-Pin SSOP
SP3222EUCA/TR .....	0°C to +70°C .....	20-Pin SSOP
SP3222EUCP .....	0°C to +70°C .....	18-Pin PDIP
SP3222EUCT .....	0°C to +70°C .....	18-Pin WSOIC
SP3222EUCT/TR .....	0°C to +70°C .....	18-Pin WSOIC
SP3222EUCY .....	0°C to +70°C .....	20-Pin TSSOP
SP3222EUCY/TR .....	0°C to +70°C .....	20-Pin TSSOP
SP3232EUCA .....	0°C to +70°C .....	16-Pin SSOP
SP3232EUCA/TR .....	0°C to +70°C .....	16-Pin SSOP
SP3232EUCP .....	0°C to +70°C .....	16-Pin PDIP
SP3232EUCT .....	0°C to +70°C .....	16-Pin WSOIC
SP3232EUCT/TR .....	0°C to +70°C .....	16-Pin WSOIC
SP3232EUCY .....	0°C to +70°C .....	16-Pin TSSOP
SP3232EUCY/TR .....	0°C to +70°C .....	16-Pin TSSOP
SP3232EUCN.....	0°C to +70°C .....	16-Pin nSOIC
SP3232EUCN/TR.....	0°C to +70°C .....	16-Pin nSOIC
SP3222EUEA .....	-40°C to +85°C .....	20-Pin SSOP
SP3222EUEA/TR .....	-40°C to +85°C .....	20-Pin SSOP
SP3222EUEY .....	-40°C to +85°C .....	20-Pin TSSOP
SP3222EUEY/TR .....	-40°C to +85°C .....	20-Pin TSSOP
SP3232EUEA .....	-40°C to +85°C .....	16-Pin SSOP
SP3232EUEA/TR .....	-40°C to +85°C .....	16-Pin SSOP
SP3232EUEY .....	-40°C to +85°C .....	16-Pin TSSOP
SP3232EUEY/TR .....	-40°C to +85°C .....	16-Pin TSSOP

Available in lead free packaging. To order add “-L” suffix to part number.

Example: SP3232EUCN/TR = standard; SP3232EUCN-L/TR = lead free

/TR = Tape and Reel

Pack quantity is 1,500 for SSOP, TSSOP, or WSOIC and 2,500 for NSOIC.



ANALOG EXCELLENCE

Sipex Corporation

Headquarters and  
Sales Office

233 South Hillview Drive  
Milpitas, CA 95035  
TEL: (408) 934-7500  
FAX: (408) 935-7600

Sipex Corporation reserves the right to make changes to any products described herein. Sipex does not assume any liability arising out of the application or use of any product or circuit described herein; neither does it convey any license under its patent rights nor the rights of others.