

**High Density**

**Low Cost**

**Modular and Scaleable**

**Hot Plug N+1 Redundancy**

**Integral Diagnostics**

**Automatic Fault Reset**

**Wide Range Input & Power Factor Correction**

**Battery Plant Compliant**

**Front Panel Monitoring**

**Bellcore Compliant**

**Worldwide Safety Agency Approvals**

**Standard Racking System**

Lambda's FE Series modular front ends are the ideal foundation for fault-tolerant distributed power architectures. Designed specifically for telecommunications and high-end computer applications, the FE Series is available in 24 or 48 VDC output modules. Delivering from 500W to 6kW of scalable power, all models are Bellcore and ETSI compliant, and meet FCC Class B EMI emissions standards when mounted in "N" or "L" version rack systems. In addition, the FE Series takes up 35% less space than the nearest competitor, and features remote diagnostics, overvoltage and overtemperature protection for remote site use. Hot pluggable and N+N redundant, Lambda's FE Series Power Modules and FE Series Racking System are the most reliable, cost efficient system solutions available. They make designing, building and qualifying your system easier, quicker, and much less expensive.

**Similar products**

**Page**

<b>JFS</b>	Chassis Mount	28
<b>PD600</b>	Convection Cooled	64
<b>WLR2800</b>	Higher Power	70

<b>AC Input</b> .....	85-265VAC, 47-63Hz for FE0500, FE1000 & FE1500. 170-265VAC, 47-63Hz for FE2000.
<b>Efficiency</b> .....	79% typical for 50-100% load without isolation diodes.
<b>Power Factor Correction</b> ....	0.95 minimum at full load. Compliant to EN60555-2.
<b>Hot Maintenance</b> .....	Unit is capable of being inserted and extracted with all operational voltages present, with or without Or-ing diode option.
<b>Surge Current Capability</b> ...	±10% of max. unit load from 10% to 100% load. Current sharing is accomplished via a single wire connection.
<b>Surge Immunity</b> .....	IEC-1000-5 Level 3 Standard. IEC-1000-5 Level 4, with external MOV's. EN61000-4 (-2,-3,-4,-5,-6,)
<b>Conducted EMI</b> .....	Module/"X" Rack System: FCC-CFR Part 15, Class A. EN55022 Class A, for conducted & radiated emissions. "L" & "N" Rack Systems: FCC-CFR Part 15, Class B and, EN55022, Class B for Conducted. FCC-CFR Part 15, Class A and EN55022 Class A for radiated emissions.
<b>Conducted Battery Noise</b> ...	Bellcore TR-NWT-001089, TR-TSY000947, Cisprr 22 Phosphometric Noise.
<b>Line Regulation</b> .....	1.0% from no load to full load. 85-265VAC (170-265VAC for FE2000).
<b>Ripple and Noise</b> .....	250mV pk-pk max on 24V model. 500mV pk-pk on 48V model. EIAJ RC-9002A procedure (20Mhz bandwidth limit).
<b>Auxiliary Bias Supply</b> .....	12VDC at 50mA.
<b>Hold-up Time</b> .....	Output will be maintained above lower limit of output voltage range for 16msec. Upon loss/disconnect of AC input, when operated at Vout nominal/full load.
<b>Overvoltage Protection</b> ....	Adjustable non-latching unit shutdown.
<b>Overload Protection</b> .....	The power module limits the output current to approximately 110% of the full power rating. The module will withstand an indefinite short circuit without damage and is self-recovering.
<b>Operating Temperature Range</b>	-40°C to +70°C ambient. (-40°C requires 30 min. warmup; 50°C to 70°C, derating required.
<b>Storage Temperature</b> .....	-40°C to +85°C.
<b>Humidity</b> .....	0 to 95% (non-condensing).
<b>Temperature Drift</b> .....	±2% over the entire temperature range and life.
<b>Isolation</b> .....	Input to Chassis -1.5K VAC. Input to Output - 3.0K VAC. Output to Chassis -500 VDC.
<b>Vibration and Shock</b> .....	NEBS rack system compliant with Bellcore GR-63-CORE, ZONE 4, Upper Level.
<b>Output Good Signal</b> .....	Signal indicates output is present and inverter is operational.
<b>Input Good Signal</b> .....	Provides fault status on AC line.
<b>Led Status Indicator</b> .....	AC GOOD LED - Indicates input power is present. DC GOOD LED - Indicates DC output voltage is present. OT LED - Indicates thermal shutdown has occurred. OUTPUT CURRENT LED - Ladder displays approximate percentage of output current.
<b>Overtemperature Protection</b> .	Internal circuitry prevents damage in the event of excessive ambient operating temperature. The output spontaneously returns when the overtemperature condition is cleared.
<b>Remote On/Off</b> .....	Standard: Contact closure or TTL Low - output enabled. Contact open or TTL High - output disabled.
<b>Safety Agency Approval</b> ....	UL1950, IEC950, EN 60950, CSA 22.2-234, CE MARK (LVD)
<b>Warranty</b> .....	2 years.

#### Individual Modules

OUTPUT (ADJ)	POWER (W)	MAX CURRENT (A)	MODEL
24V (20-29)	500	25.0	FE0500-24NA
	500	25.0	FE0500-24RA <sup>1</sup>
	1000	50.0	FE1000-24NA
	1000	50.0	FE1000-24RA <sup>1</sup>
	1500	75.0	FE1500-24NA
	1500	75.0	FE1500-24RA <sup>1</sup>
48V (40-58)	2000	91.0	FE2000-24NA
	2000	91.0	FE2000-24RA <sup>1</sup>
	500	11	FE0500-48NA
	500	11	FE0500-48RA <sup>1</sup>
	1000	21	FE1000-48NA
	1000	21	FE1000-48RA <sup>1</sup>
	1500	32	FE1500-48NA
	1500	32	FE1500-48RA <sup>1</sup>
	2000	42	FE2000-48NA
	2000	42	FE2000-48RA <sup>1</sup>

<sup>1</sup> Redundant, or-ing diodes included in this model.

#### Racking Systems

500W	MAXIMUM NUMBER OF MODULES		MODEL
	1000W	1500/2000W	
8			FE4K-X*
7			FE4K-N*
5			FE4K-L*-24
5			FE4K-L*-48
	5		FE5K-X*
	4		FE5K-N*
	3		FE5K-L*-24
	3		FE5K-L*-48
		3	FE6K-X*
		3	FE6K-N*
		2	FE6K-L*-24
		2	FE6K-L*-48

\* Specify **N** for NEBS/Telcom (24"), or **E** for EIA (19")  
EIA Mounting Flanges are located at the front of the Rack.  
Telcom mounting flanges are center mounted per Bellcore NEBS requirements.

Filler panels are available, please contact factory for details.



## FE-500

## FE-1000

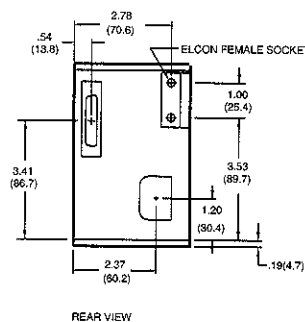
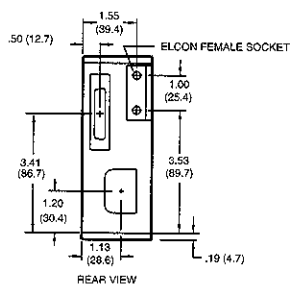
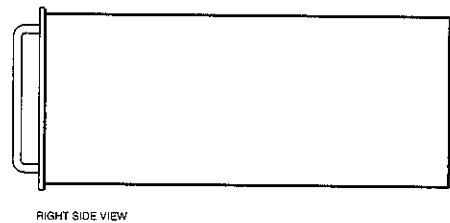
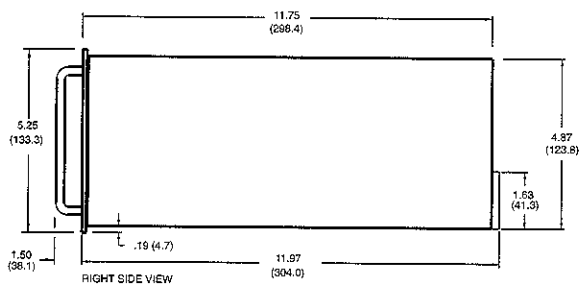
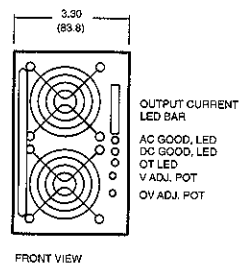
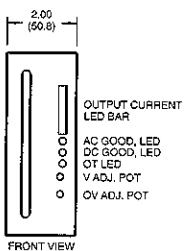

WEIGHT: NET 6.0 LBS, SHIPPING 7.0 LBS

WEIGHT: NET 7.0 LBS, SHIPPING 8.0 LBS

# FE-1500/2000

# FE RACK

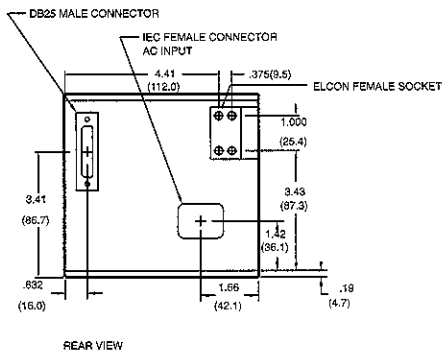
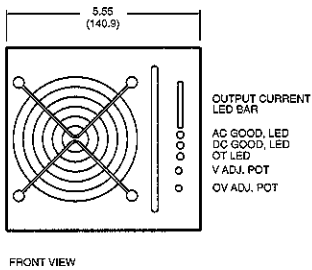

WEIGHT: NET 9.0 LBS, SHIPPING 10.0 LBS

