





Bikonvexlinsen, gefasst, Durchmesser 6 - 22.4 mm







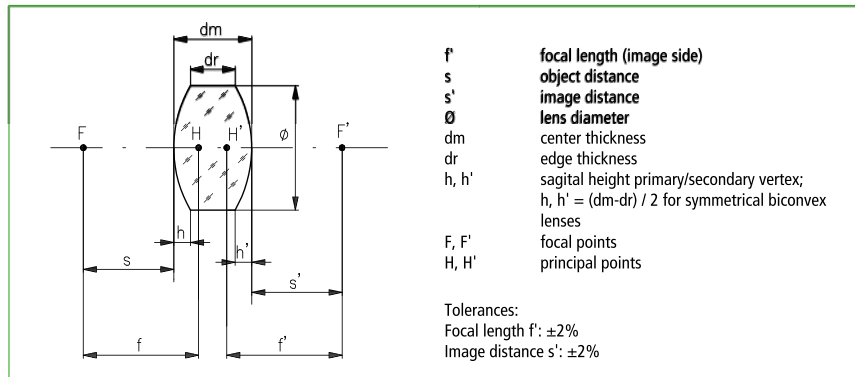













- In Fassungen kompatibel zur Mikrobank  oder Nanobank 
- Linsen bester Form für 1:1-Abbildungen
- Unbeschichtet
- Toleranzen: Brennweite f' : $\pm 2\%$, Bildentfernung s' : $\pm 2\%$
- Zwei gleiche Krümmungsradien

Symmetric-Convex Lenses, Mounted, Dia. 6 - 22.4 mm

- Lens mounts fit to Microbench  or Nanobench 
- Precision designed for 1:1 imaging
- Surfaces uncoated
- Tolerances: Focal length f' : $\pm 2\%$, Image distance s' : $\pm 2\%$
- Two equal radii of curvature



Bikonvexlinsen, gefasst, Durchmesser 6 - 22.4 mm Symmetric-convex lenses, mounted, dia. 6 - 22.4 mm

Fassung	Brennweite (mm)	Optik- ϕ (mm)	Material	Außen- ϕ D (mm)	Freier- ϕ (mm)	dm (mm)	dr (mm)	$s, s'_{588\text{ nm}}$ (mm)	$f'_{546\text{ nm}}$ (mm)	Θ^*	Part No.
Mount	Focal length (mm)	ϕ optics (mm)	Material	Outer- ϕ D (mm)	Clear ϕ (mm)	dm (mm)	dr (mm)	$s, s'_{588\text{ nm}}$ (mm)	$f'_{546\text{ nm}}$ (mm)	Θ^*	Part No.
	5	6	N-BaK4	16	5	2.9	0.9	3.95	4.97	5	G052201000
	7	8	N-BaK4	16	7	3.4	1.1	6	7.14	5	G052202000
	10	10	N-BaK4	16	9	3.5	1	8.78	9.93	9	G052203000
	12.5	12.5	N-BK7	16	11.5	4.5	1	10.79	12.33	9	G052204000
	15	12.7	N-BK7	16	11.5	4	1.1	13.58	14.91	9	G052205000
	20	12.7	N-BK7	16	11.5	3	0.9	18.94	19.88	9	G052206000
	30	12.7	N-BK7	16	11.5	3	1.6	28.8	29.7	9	G052207000
	50	12.7	N-BK7	16	11.5	3	2.2	48.92	49.74	9	G052208000
	100	12.7	N-BK7	16	11.5	3	2.6	99.08	99.7	9	G052210000
	150	12.7	N-BK7	16	11.5	3	2.7	148.5	148.9	9	G052211000
	16	18	N-BK7	25	17	7	1.1	13.43	15.88	9	G063033000
	20	22.4	N-BK7	25	21.4	8.8	1.6	17.05	20.13	13	G063020000
	25	22.4	N-BK7	25	21.4	7	1.6	22.4	24.74	13	G063021000
	30	22.4	N-BK7	25	21.4	6.3	2	28.01	30.06	13	G063022000
	40	22.4	N-BK7	25	21.4	5	2	39.66	41.2	13	G063023000
	50	22.4	N-BK7	25	21.4	4.5	2.1	49.88	51.19	13	G063024000
	60	22.4	N-BK7	25	21.4	4	2	59.94	61.05	13	G063025000
	80	22.4	N-BK7	25	21.4	3.5	2	80.24	81.1	13	G063026000
	100	22.4	N-BK7	25	21.4	3.5	2.3	100.44	101.22	13	G063027000
	150	22.4	N-BK7	25	21.4	3	2.2	150.65	151.08	13	G063028000
	200	22.4	N-BK7	25	21.4	3	2.4	202.51	202.75	13	G063029000

Θ^* Eine Tabelle mit weiteren Spezifikationen finden Sie zu Beginn dieses Kapitels.
Please find more specifications in the table at the beginning of this chapter.