

320553 ✓ ACTIVE



PIDG

TE Internal #: 320553

Ring Terminals & Spade Terminals, Ring Tongue, 22 – 16 AWG

Wire Size, .3 – 1.42 mm² Wire Size, 509 – 3260 CMA Wire Size, Stud

Size #4 / M2.5, PIDG

[View on TE.com >](#)

Terminals & Splices > Ring Terminals & Spade Terminals > PIDG Ring Tongue Terminals

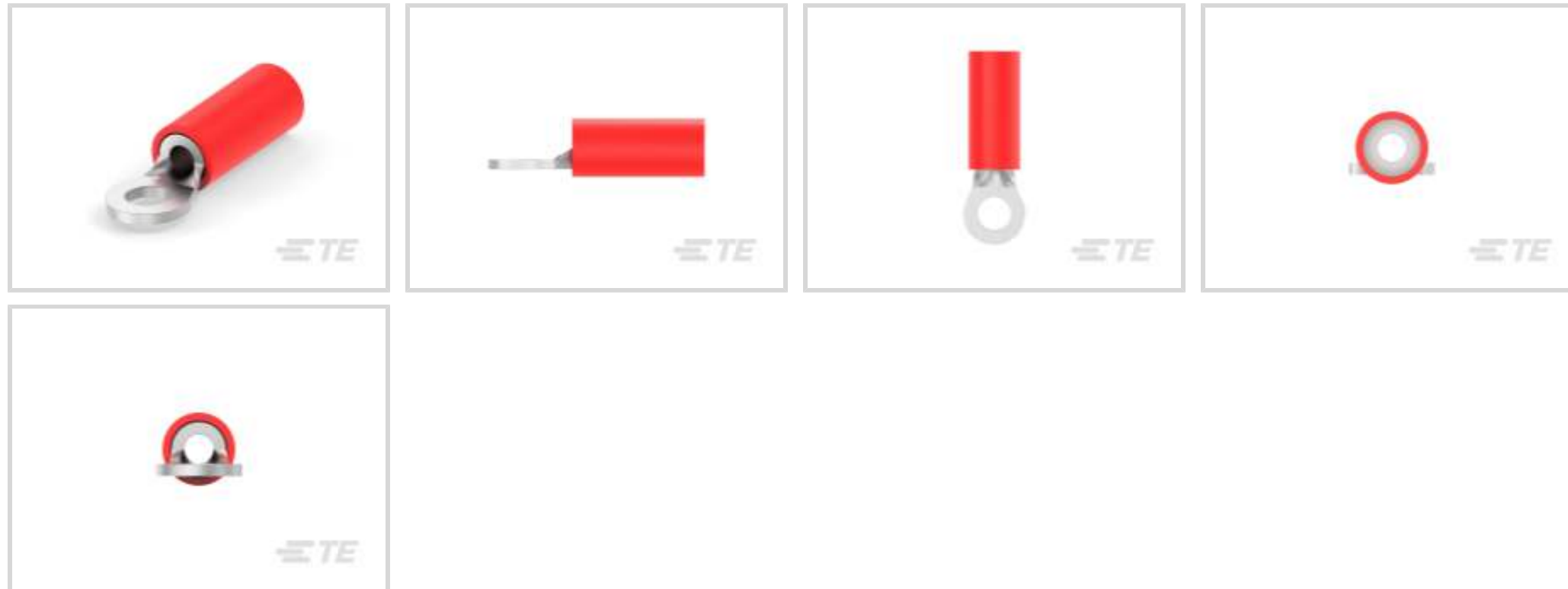

Ring & Spade Terminal Type: Ring Tongue

Wire Size: 509 – 3260 CMA

Stud Size: #4, M2.5

[All PIDG Ring Tongue Terminals \(421\)](#)

Features

Product Type Features

Stud Size	#4, M2.5
Sealable	No
Wire Insulation Support Retention Type	Non-Insulation Support

Configuration Features

Number of Holes	1
-----------------	---

Electrical Characteristics

Voltage Rating	300 V
----------------	-------

Body Features

Product Weight	.703 g
----------------	--------

Contact Features

Military Part Class	Class I
Ring & Spade Terminal Type	Ring Tongue
Barrel Type	Closed



Terminal Orientation	Straight
----------------------	----------

Terminal Plating Material	Tin
---------------------------	-----

Mechanical Attachment

Wire Insulation Support	With
-------------------------	------

Dimensions

Wire Size	509 – 3260 CMA
-----------	----------------

Stud Diameter	3.02 mm[.119 in]
---------------	------------------

Tongue Thickness	.79 mm[.031 in]
------------------	-----------------

Product Length	17.07 mm[.672 in]
----------------	-------------------

Compatible Insulation Diameter (Max)	3.18 mm[.125 in]
--------------------------------------	------------------

Compatible Insulation Diameter Range	2.03 – 3.18 mm[.08 – .125 in]
--------------------------------------	-------------------------------

Usage Conditions

Insulation Option	Partially Insulated
-------------------	---------------------

Operating Temperature Range	105 °C[221 °F]
-----------------------------	----------------

Operation/Application

Compatible With Wire Base Material	Copper
------------------------------------	--------

Compatible With Wire Plating Material	Tin
---------------------------------------	-----

Industry Standards

Government Qualified Terminal	Yes
-------------------------------	-----

Packaging Features

Packaging Quantity	1000
--------------------	------

Packaging Method	Loose Piece
------------------	-------------

Product Compliance

[For compliance documentation, visit the product page on TE.com>](#)

EU RoHS Directive 2011/65/EU	Compliant
------------------------------	-----------

EU ELV Directive 2000/53/EC	Compliant
-----------------------------	-----------

China RoHS 2 Directive MIIT Order No 32, 2016	No Restricted Materials Above Threshold
---	---

EU REACH Regulation (EC) No. 1907/2006	Current ECHA Candidate List: JUNE 2023 (235) Candidate List Declared Against: JUNE 2023 (235) Does not contain REACH SVHC
--	---

Halogen Content

Low Halogen - Br, Cl, F, I < 900 ppm per homogenous material. Also BFR/CFR/PVC Free

Solder Process Capability

Not applicable for solder process capability

Product Compliance Disclaimer

This information is provided based on reasonable inquiry of our suppliers and represents our current actual knowledge based on the information they provided. This information is subject to change. The part numbers that TE has identified as EU RoHS compliant have a maximum concentration of 0.1% by weight in homogenous materials for lead, hexavalent chromium, mercury, PBB, PBDE, DBP, BBP, DEHP, DIBP, and 0.01% for cadmium, or qualify for an exemption to these limits as defined in the Annexes of Directive 2011/65/EU (RoHS2). Finished electrical and electronic equipment products will be CE marked as required by Directive 2011/65/EU. Components may not be CE marked. Additionally, the part numbers that TE has identified as EU ELV compliant have a maximum concentration of 0.1% by weight in homogenous materials for lead, hexavalent chromium, and mercury, and 0.01% for cadmium, or qualify for an exemption to these limits as defined in the Annexes of Directive 2000/53/EC (ELV). Regarding the REACH Regulation, the information TE provides on SVHC in articles for this part number is based on the latest European Chemicals Agency (ECHA) 'Guidance on requirements for substances in articles' posted at this URL: <https://echa.europa.eu/guidance-documents/guidance-on-reach>

Compatible Parts



REPRESENTATION ONLY

TE Part # 47386
DAHT PG PIDG 26-16 ASSY



REPRESENTATION ONLY

TE Part # 47386-4
DAHT PG PIDG 26-16 ASSY



TE Part # 58433-3
PRO CR ASSY, RBY IS9252



TE Part # 59250
T-HEAD PIDG 26-14 ASSY



TE Part # 58423-1
DIE, RBY IS9252



TE Part # 59824-1
TETRA-CRIMP PIDG PG FASTON 22-10 ASSY



REPRESENTATION ONLY

TE Part # 525690
DAHT PG PIDG 20-18 ASSY



TE Part # 539691-2
ERGO DIE R.B.Y



TE Part # 2063030-1
SDE DIESET, RBY, UL



TE Part # 47806-2
DIES PIDG 22-16 DIE SET



TE Part # 59300
T-HEAD PIDG PG 26-16 ASSY



TE Part # 169400
CERTI-LOK FRAME W/O DIES

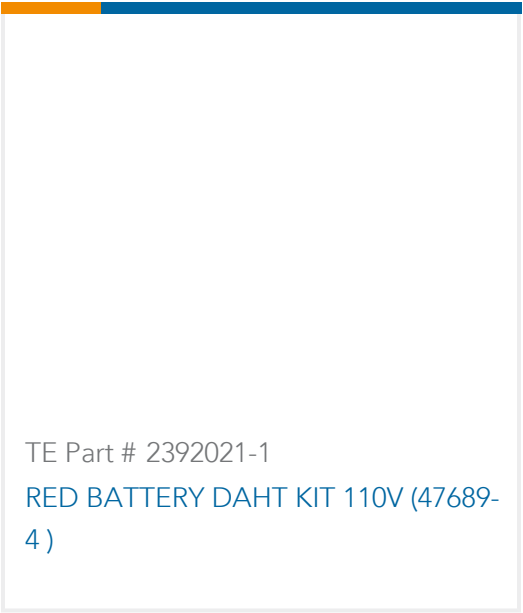
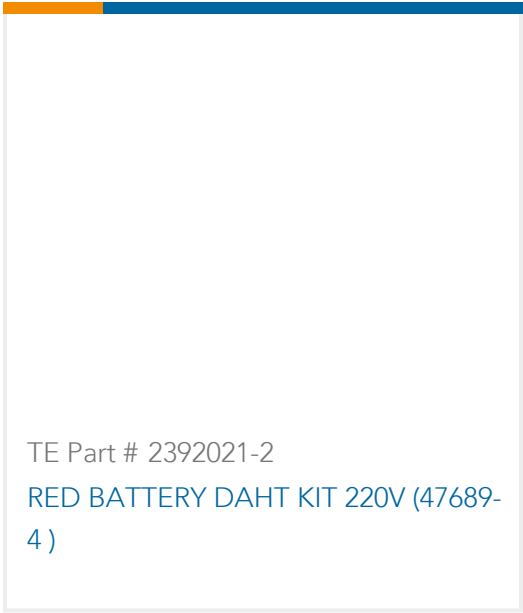

Also in the Series | PIDG

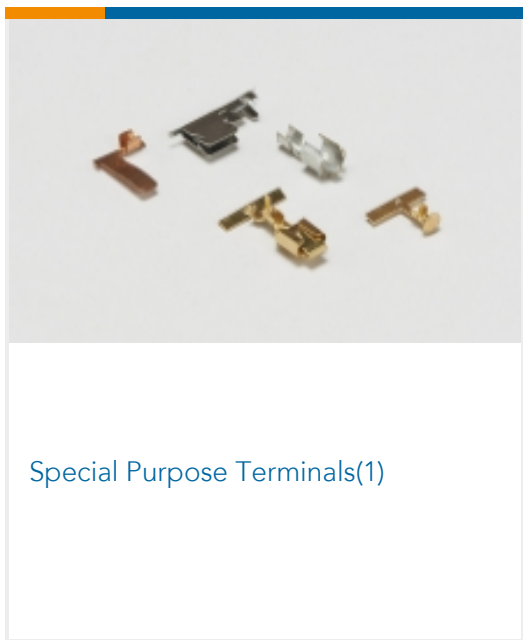
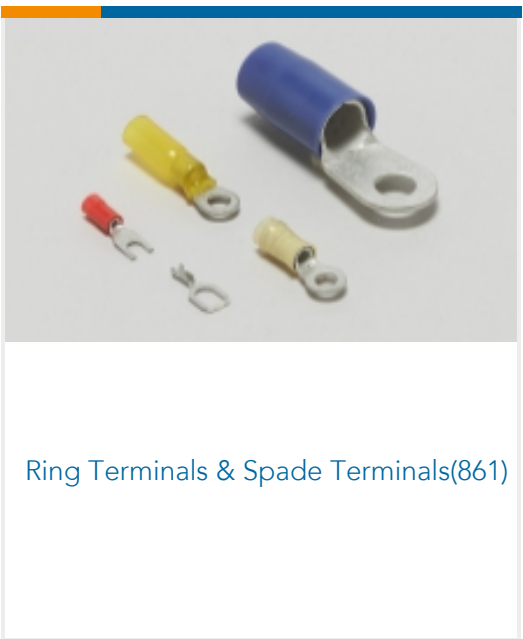
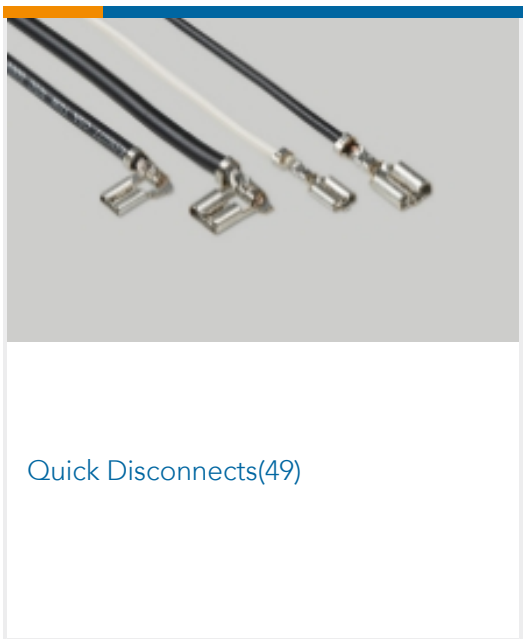
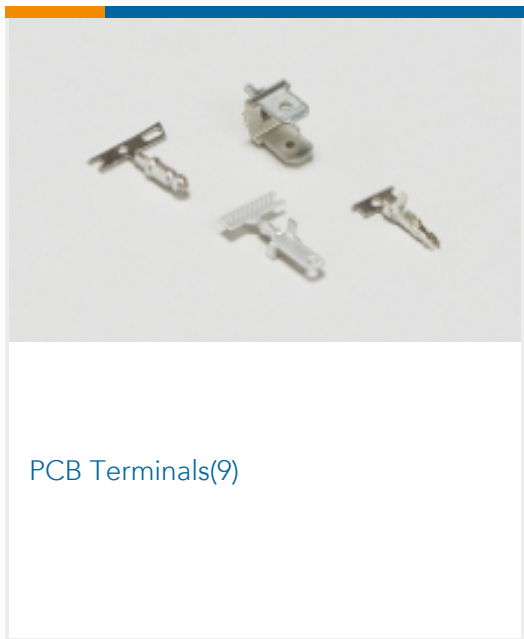
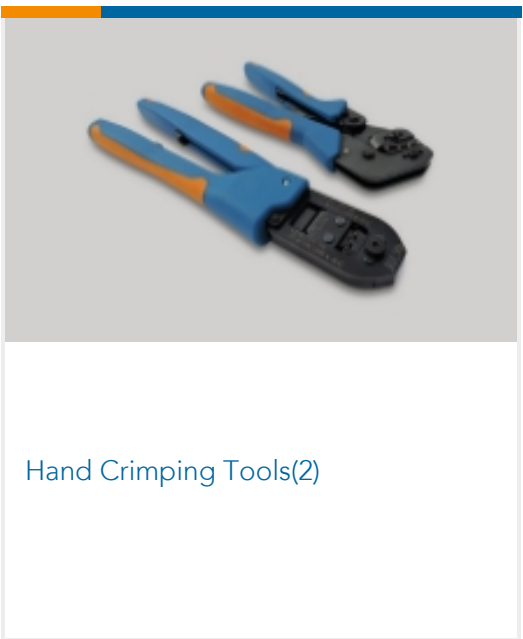
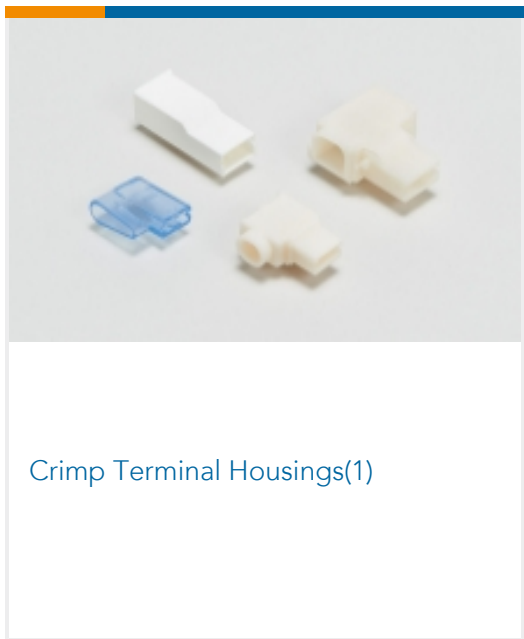
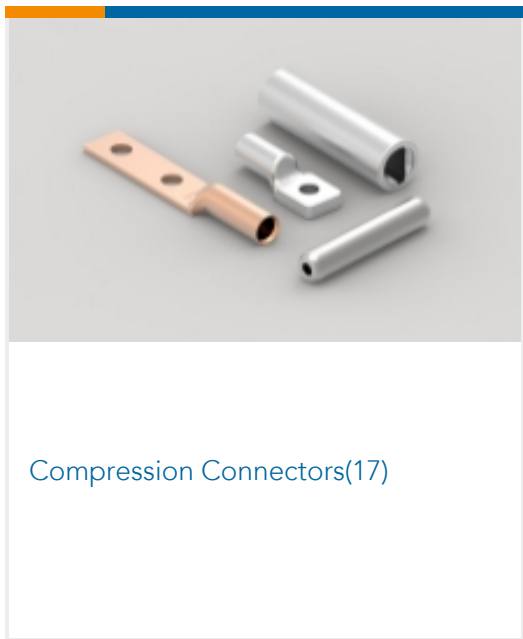

Customers Also Bought

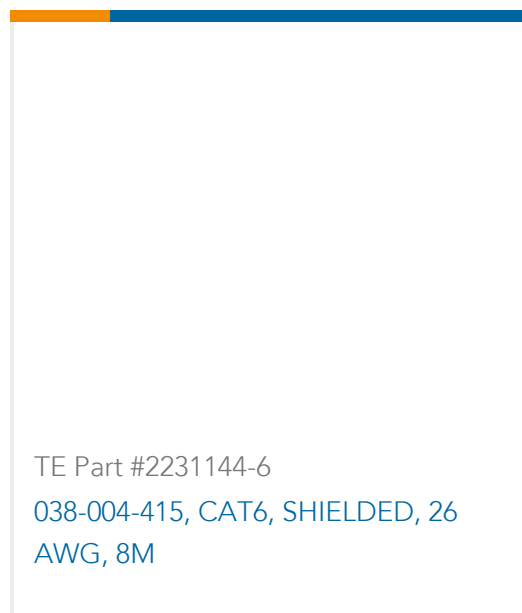
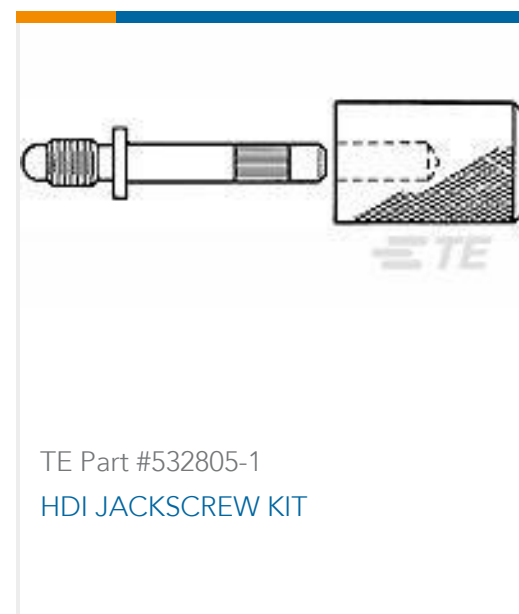

Documents

Product Drawings

[PIDG R 22-16 COMM 22-18 MIL 4](#)

English

CAD Files

[3D PDF](#)

3D

Customer View Model

[ENG_CVM_CVM_320553_Y.2d_dxf.zip](#)

English

Customer View Model

[ENG_CVM_CVM_320553_Y.3d_igs.zip](#)

English

Customer View Model

[ENG_CVM_CVM_320553_Y.3d_stp.zip](#)

English

[3D PDF](#)

English

Customer View Model

[ENG_CVM_320553_J.2d_dxf.zip](#)

English

Customer View Model

[ENG_CVM_320553_J.3d_igs.zip](#)

English

Customer View Model

[ENG_CVM_320553_J.3d_stp.zip](#)

English



By downloading the CAD file I accept and agree to the [Terms and Conditions](#) of use.

Datasheets & Catalog Pages

[PIDG TERMINALS & SPLICES Quick Reference Guide](#)

English

Product Specifications

[Application Specification](#)

English

Product Environmental Compliance

[MD_320553_021920182243_dmtec](#)

English

[MD_320553_021920182243_dmtec](#)

English

Agency Approvals

[UL Report](#)

English

[UL Report](#)

English