

WINNIE-W

~50° wide beam. Holder with 35 mm screw hole distance according to Zhaga standard. Compatible with Bender+Wirth 4xx Typ L5 connector.

SPECIFICATION:

| | |
|----------------|---|
| Dimensions | Ø 49.8 mm |
| Height | 19.3 mm |
| Fastening | screw |
| ROHS compliant | yes  |



MATERIALS:

| Component | Type | Material | Colour | Finish |
|----------------------|-------------|----------|--------|--------|
| C14234_WINNIE-W | Single lens | PMMA | clear | |
| C14235_WINNIE-HOLDER | Holder | PC | white | |

ORDERING INFORMATION:

Quantities for one set:

| | |
|-------------|---|
| Single lens | 1 |
| Holder | 1 |

| Component | | Qty in box | MOQ | MPQ | Box weight (kg) |
|--------------------------------|-------------|------------|-----|-----|-----------------|
| C14234_WINNIE-W | Single lens | 364 | 84 | 28 | 5.6 |
| » Box size: 480 x 280 x 300 mm | | | | | |
| C14235_WINNIE-HOLDER | Holder | 1820 | 84 | 28 | 7.2 |
| » Box size: 480 x 280 x 300 mm | | | | | |

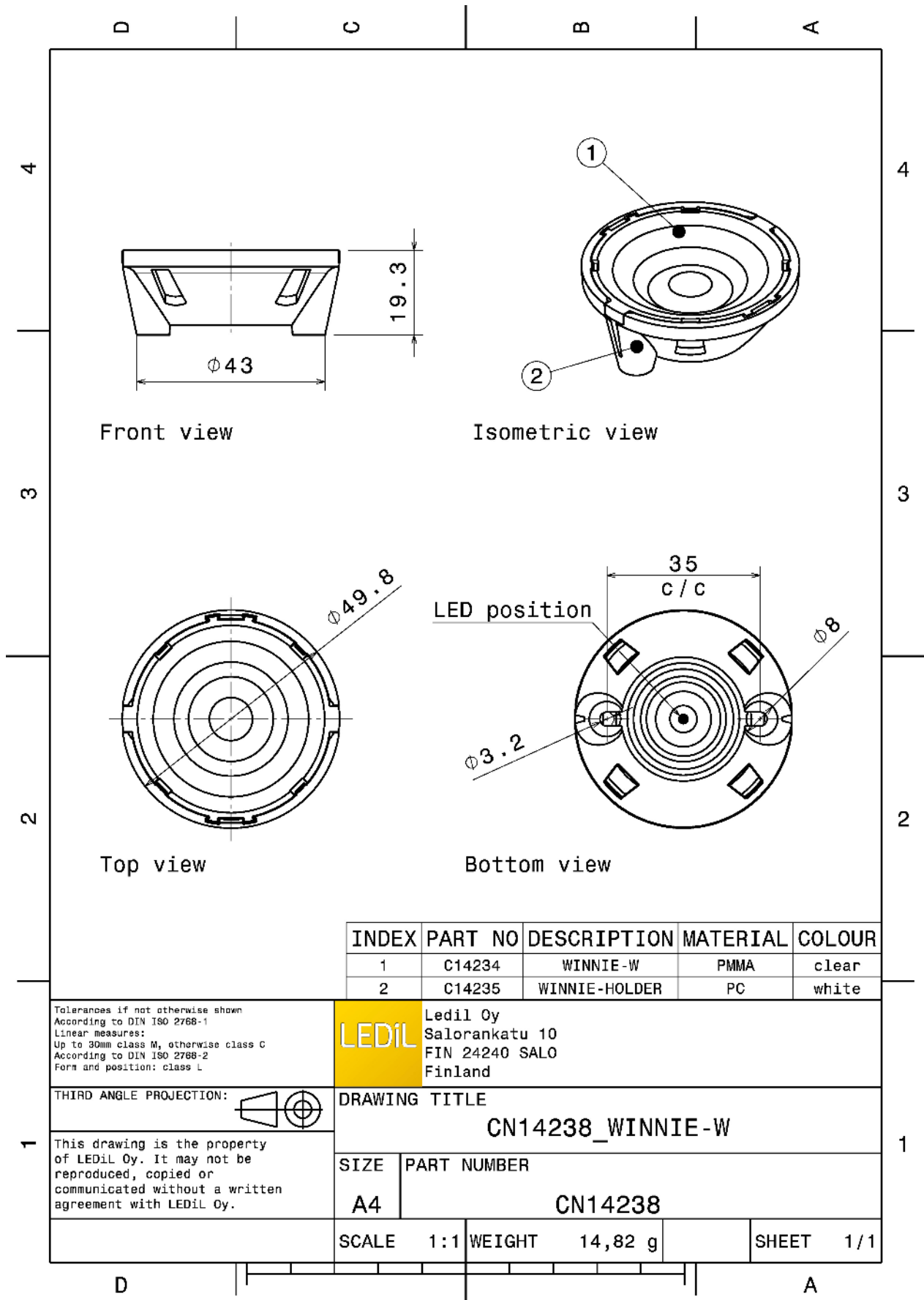

| INDEX | PART NO | DESCRIPTION | MATERIAL | COLOUR |
|-------|---------|---------------|----------|--------|
| 1 | C14234 | WINNIE-W | PMMA | clear |
| 2 | C14235 | WINNIE-HOLDER | PC | white |

Tolerances if not otherwise shown
According to DIN ISO 2768-1
Linear measures:
Up to 30mm class M, otherwise class C
According to DIN ISO 2768-2
Form and position: class L

LEDiL Ledil Oy
Salorankatu 10
FIN 24240 SALO
Finland

THIRD ANGLE PROJECTION:

DRAWING TITLE
CN14238_WINNIE-W







This drawing is the property of LEDiL Oy. It may not be reproduced, copied or communicated without a written agreement with LEDiL Oy.

| SIZE | PART NUMBER |
|------|-------------|
| A4 | CN14238 |

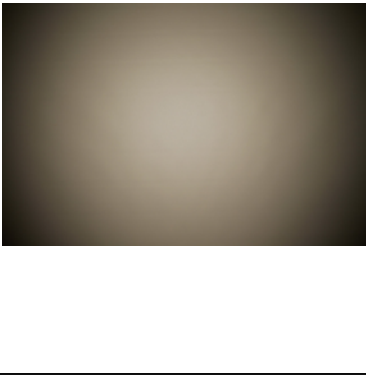
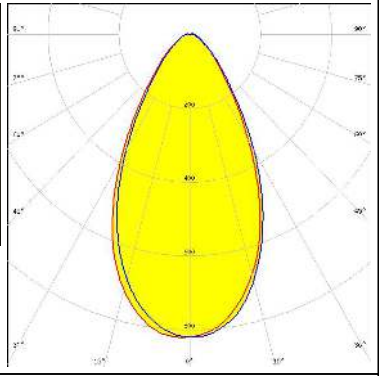
| | | | | | |
|-------|-----|--------|---------|-------|-----|
| SCALE | 1:1 | WEIGHT | 14,82 g | SHEET | 1/1 |
|-------|-----|--------|---------|-------|-----|

See also our general installation guide: www.ledil.com/installation_guide

OPTICAL RESULTS (MEASURED):

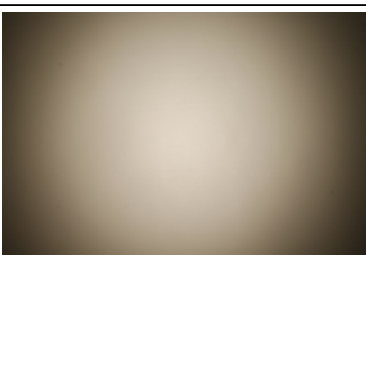
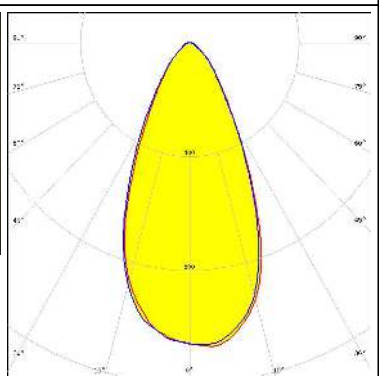
| | | |
|---|--|---|
| <p></p> <p>LED V18 Gen6 FWHM / FWTM 56.0° / 102.0° Efficiency 88 % Peak intensity 0.8 cd/lm LEDs/each optic 1 Light colour White Required components:</p> |  |  |
| <p></p> <p>LED V6 Gen6 FWHM / FWTM 47.0° / 92.0° Efficiency 87 % Peak intensity 1.2 cd/lm LEDs/each optic 1 Light colour White Required components:</p> |  | |
| <p></p> <p>LED V8 Gen6 FWHM / FWTM 48.0° / 92.0° Efficiency 88 % Peak intensity 1.1 cd/lm LEDs/each optic 1 Light colour White Required components:</p> |  | |
| <p></p> <p>LED VERO10 FWHM / FWTM 49.0° / 90.0° Efficiency 90 % Peak intensity 1.1 cd/lm LEDs/each optic 1 Light colour White Required components:</p> |  |  |

OPTICAL RESULTS (MEASURED):

CITIZEN

LED CLL01x
 FWHM / FWTM 45.0° / 90.0°
 Efficiency 87 %
 Peak intensity 1.2 cd/lm
 LEDs/each optic 1
 Light colour White
 Required components:

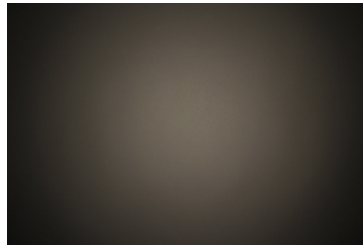

CITIZEN

LED CLL02x/CLU02x (LES10)
 FWHM / FWTM 46.0° / 90.0°
 Efficiency 87 %
 Peak intensity 1.6 cd/lm
 LEDs/each optic 1
 Light colour White
 Required components:

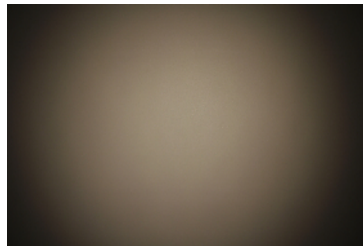

CITIZEN

LED CLL02x/CLU02x (LES10)
 FWHM / FWTM 46.0° / 88.0°
 Efficiency 87 %
 Peak intensity 1.1 cd/lm
 LEDs/each optic 1
 Light colour White
 Required components:
 Bender Wirth: 434 Typ L5

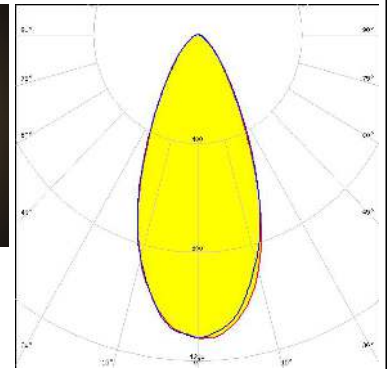
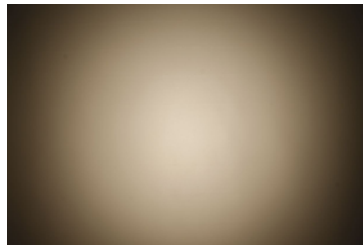

CITIZEN

LED CLL03x/CLU03x
 FWHM / FWTM 48.0° / 91.0°
 Efficiency 88 %
 Peak intensity 1 cd/lm
 LEDs/each optic 1
 Light colour White
 Required components:
 Bender Wirth: 433 Typ L5

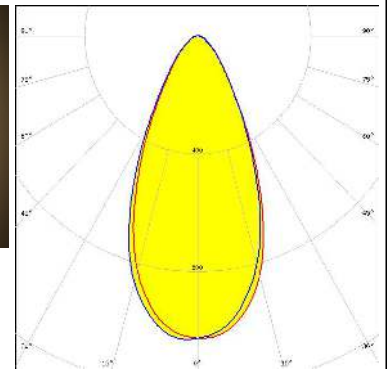
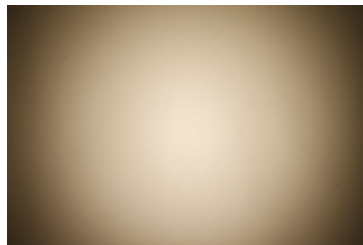

OPTICAL RESULTS (MEASURED):

CITIZEN

LED CLU700/701/702/703
 FWHM / FWTM 42.0° / 83.0°
 Efficiency 88 %
 Peak intensity 1.3 cd/lm
 LEDs/each optic 1
 Light colour White
 Required components:

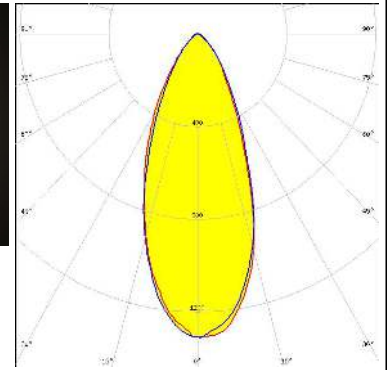
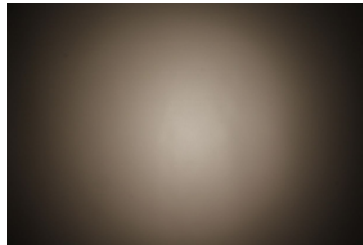

CITIZEN

LED CLU700/701/702/703
 FWHM / FWTM 42.0° / 84.0°
 Efficiency 88 %
 Peak intensity 1.3 cd/lm
 LEDs/each optic 1
 Light colour White
 Required components:
 Bender Wirth: 434 Typ L5

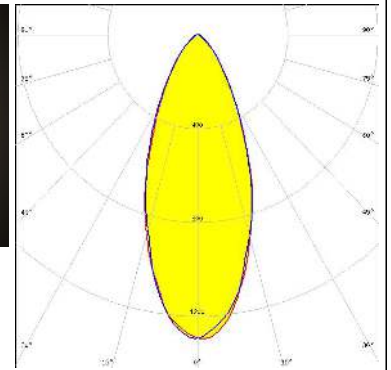
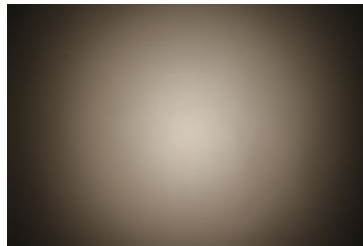

CITIZEN

LED CLU710/711
 FWHM / FWTM 45.0° / 86.0°
 Efficiency 88 %
 Peak intensity 1.2 cd/lm
 LEDs/each optic 1
 Light colour White
 Required components:
 Bender Wirth: 470 Typ L5

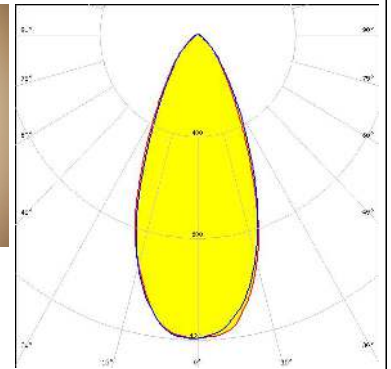
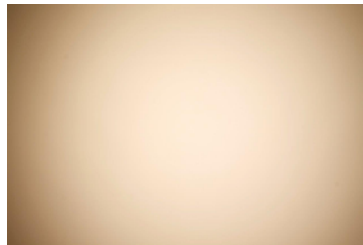

CITIZEN

LED CLU710/711
 FWHM / FWTM 47.0° / 93.0°
 Efficiency 87 %
 Peak intensity 1 cd/lm
 LEDs/each optic 1
 Light colour White
 Required components:

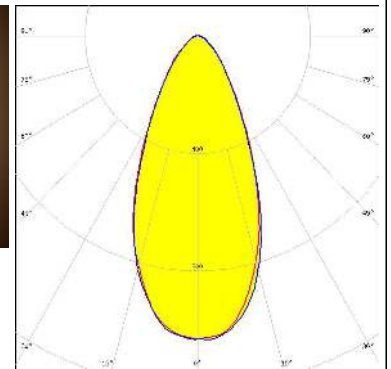
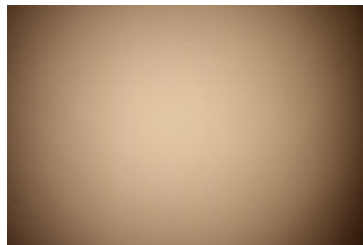

OPTICAL RESULTS (MEASURED):

CITIZEN

LED CLU720/721/723
 FWHM / FWTM 45.0° / 85.0°
 Efficiency 87 %
 Peak intensity 1.2 cd/lm
 LEDs/each optic 1
 Light colour White
 Required components:
 Bender Wirth: 433 Typ L5

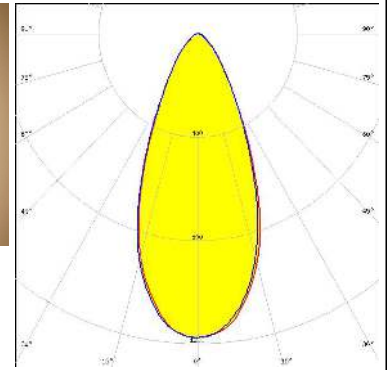
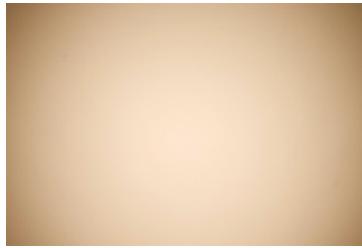

CREE LED

LED CXA/B 13xx
 FWHM / FWTM 51.0° / 96.0°
 Efficiency 89 %
 Peak intensity 1.1 cd/lm
 LEDs/each optic 1
 Light colour White
 Required components:

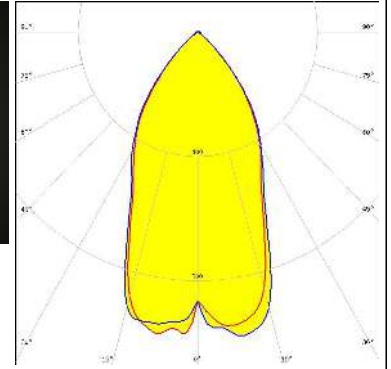
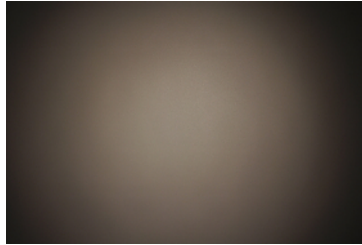

CREE LED

LED CXA/B 15xx
 FWHM / FWTM 52.0° / 96.0°
 Efficiency 87 %
 Peak intensity 1.1 cd/lm
 LEDs/each optic 1
 Light colour White
 Required components:







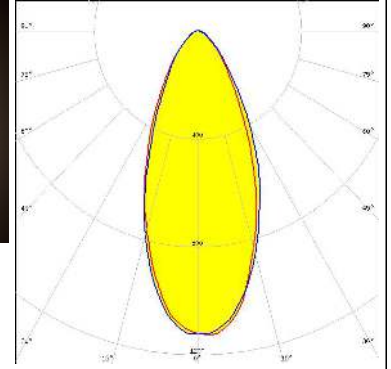

CREE LED

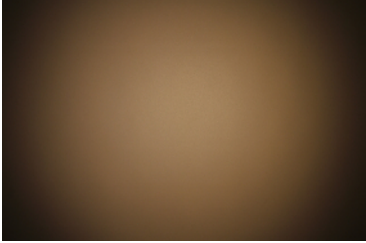
LED MHD-E/G
 FWHM / FWTM 45.0° / 91.0°
 Efficiency 88 %
 Peak intensity 1.1 cd/lm
 LEDs/each optic 1
 Light colour White
 Required components:



OPTICAL RESULTS (MEASURED):

| | |
|---|--|
|  LED LUXEON CoB 1202/1203 FWHM / FWTM 48.0° / 94.0° Efficiency 88 % Peak intensity 1.1 cd/lm LEDs/each optic 1 Light colour White Required components: |  |
|  LED LUXEON CoB 1202s FWHM / FWTM 46.0° / 90.0° Efficiency 89 % Peak intensity 1.3 cd/lm LEDs/each optic 1 Light colour White Required components: |  |
|  LED CxM-14 (19x19) FWHM / FWTM 50.0° / 96.0° Efficiency 86 % Peak intensity 1 cd/lm LEDs/each optic 1 Light colour White Required components: |  |
|  LED CxM-9 (13.5x13.5) FWHM / FWTM 48.0° / 92.0° Efficiency 90 % Peak intensity 1.3 cd/lm LEDs/each optic 1 Light colour White Required components: |  |

OPTICAL RESULTS (MEASURED):

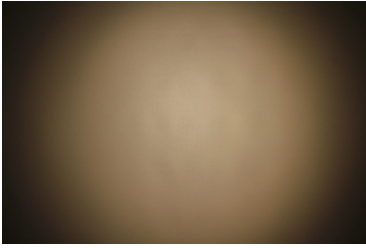
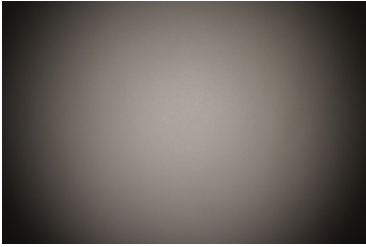
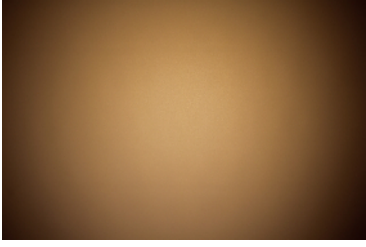
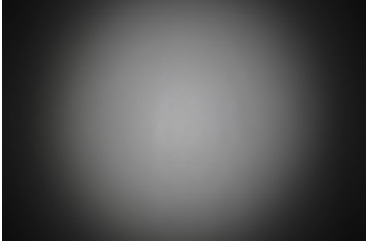
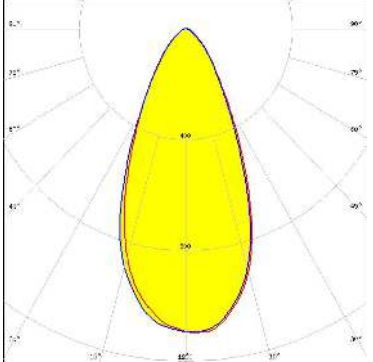
| | |
|---|--|
| <p>OSRAM Opto Semiconductors</p> <p>LED Duris S10</p> <p>FWHM / FWTM 54.0° / 90.0°</p> <p>Efficiency 88 %</p> <p>Peak intensity 1 cd/lm</p> <p>LEDs/each optic 1</p> <p>Light colour White</p> <p>Required components:</p> |  |
| <p>OSRAM Opto Semiconductors</p> <p>LED Soleriq S13</p> <p>FWHM / FWTM 49.0° / 92.0°</p> <p>Efficiency 87 %</p> <p>Peak intensity 1 cd/lm</p> <p>LEDs/each optic 1</p> <p>Light colour White</p> <p>Required components:</p> |  |
| <p>OSRAM Opto Semiconductors</p> <p>LED Soleriq S19</p> <p>FWHM / FWTM 50.0° / 94.0°</p> <p>Efficiency 84 %</p> <p>Peak intensity 1 cd/lm</p> <p>LEDs/each optic 1</p> <p>Light colour White</p> <p>Required components:</p> |  |
| <p>SAMSUNG</p> <p>LED LC003D / LC006D / LC009D / LC013D</p> <p>FWHM / FWTM 47.0° / 89.0°</p> <p>Efficiency 88 %</p> <p>Peak intensity 1.1 cd/lm</p> <p>LEDs/each optic 1</p> <p>Light colour White</p> <p>Required components:</p> |   |

OPTICAL RESULTS (MEASURED):

SAMSUNG

LED LC016D / LC019D / LC026D / LC033D
 FWHM / FWTM 52.0° / 96.0°
 Efficiency 85 %
 Peak intensity 0.9 cd/m
 LEDs/each optic 1
 Light colour White
 Required components:

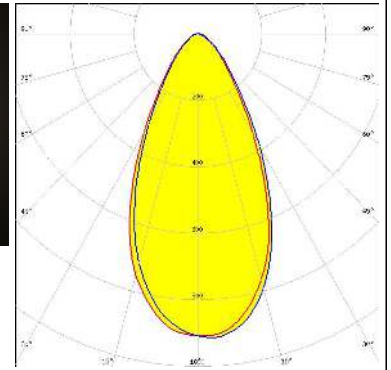
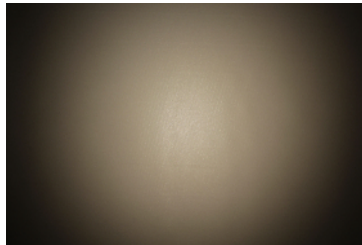

SEOUL SEMICONDUCTOR
 LED MJT COB LES 14.5
 FWHM / FWTM 51.0° / 96.0°
 Efficiency 84 %
 Peak intensity 0.9 cd/m
 LEDs/each optic 1
 Light colour White
 Required components:
 Bender Wirth: 433 Typ L5

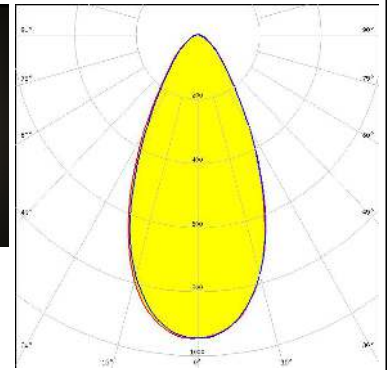
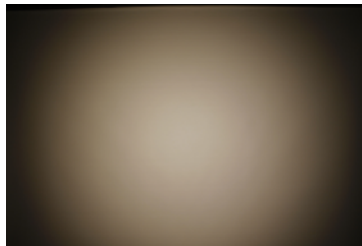

SEOUL SEMICONDUCTOR
 LED MJT COB LES 9.8
 FWHM / FWTM 46.0° / 88.0°
 Efficiency 90 %
 Peak intensity 1.1 cd/m
 LEDs/each optic 1
 Light colour White
 Required components:
 Bender Wirth: 434 Typ L5

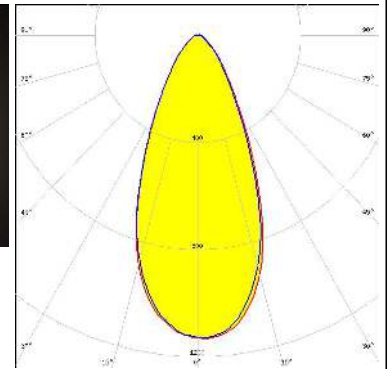

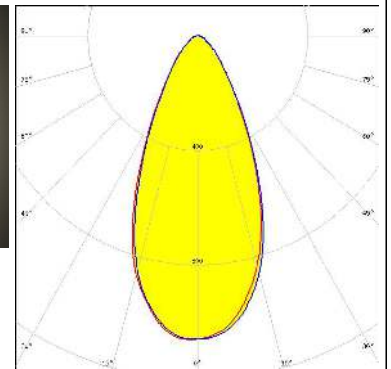
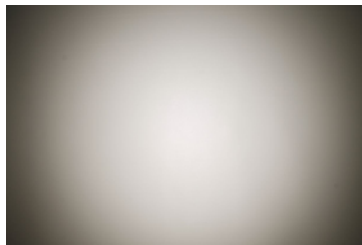

SEOUL SEMICONDUCTOR
 LED ZC12/18
 FWHM / FWTM 48.0° / 90.0°
 Efficiency 89 %
 Peak intensity 1.1 cd/m
 LEDs/each optic 1
 Light colour White
 Required components:
 Bender Wirth: 433 Typ L5

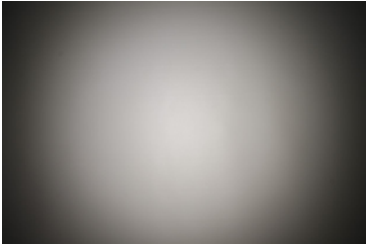
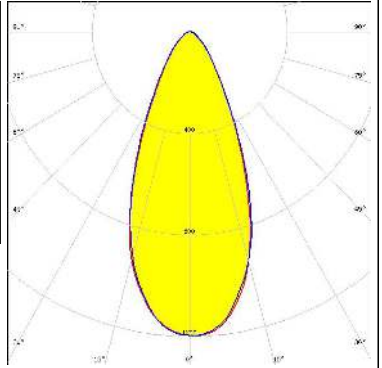
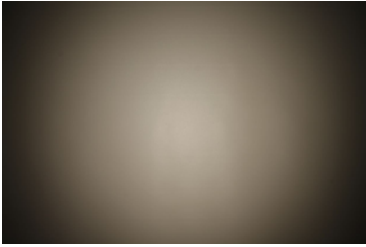
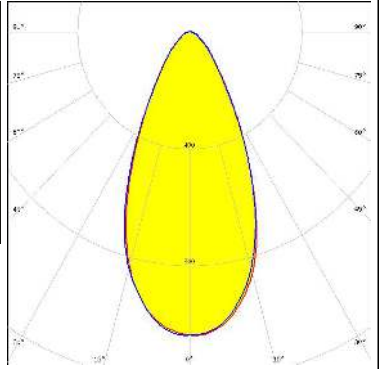

OPTICAL RESULTS (MEASURED):

| | | |
|--|---|--|
| <p>VS LIGHTING SOLUTIONS</p> <p>LED DMC 124 / 125</p> <p>FWHM / FWTM 45.0° / 84.0°</p> <p>Efficiency 89 %</p> <p>Peak intensity 1.2 cd/lm</p> <p>LEDs/each optic 1</p> <p>Light colour White</p> <p>Required components: Bender Wirth: 433 Typ L5</p> |  |  |
| <p>VS LIGHTING SOLUTIONS</p> <p>LED DMC 128</p> <p>FWHM / FWTM 49.0° / 90.0°</p> <p>Efficiency 88 %</p> <p>Peak intensity 1 cd/lm</p> <p>LEDs/each optic 1</p> <p>Light colour White</p> <p>Required components: Bender Wirth: 433 Typ L5</p> |  |  |

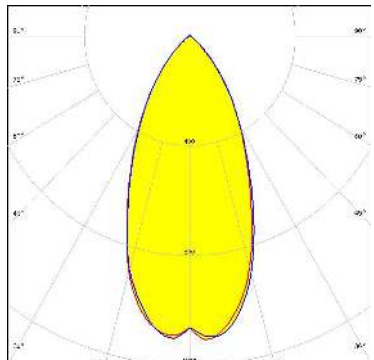
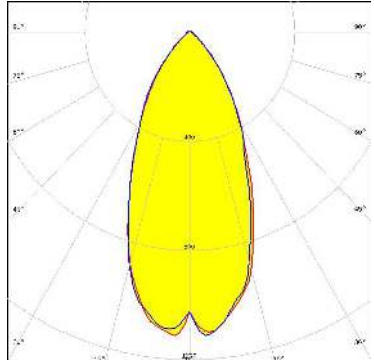
OPTICAL RESULTS (SIMULATED):

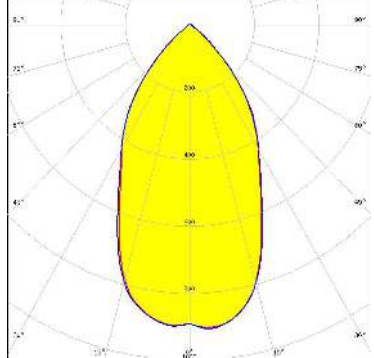
| | |
|---|---|
| <p>CREE  LED</p> <p>LED: CXA/B 15xx FWHM / FWTM: 48.0° / 88.0° Efficiency: 86 % Peak intensity: 1.1 cd/lm LEDs/each optic: 1 Light colour: White Required components: C14305_STELLA-CLAMP-CXA15-18</p> |  |
| <p>LUMILEDS</p> <p>LED: LUXEON CoB 1202/1203 FWHM / FWTM: 47.0° / 88.0° Efficiency: 89 % Peak intensity: 1.2 cd/lm LEDs/each optic: 1 Light colour: White Required components: Bender Wirth: 441 Typ L5</p> |  |
| <p>LUMILEDS</p> <p>LED: LUXEON CoB Compact FWHM / FWTM: 46.0° / 90.0° Efficiency: 89 % Peak intensity: 1.3 cd/lm LEDs/each optic: 1 Light colour: White Required components:</p> |  |
| <p>LUMILEDS</p> <p>LED: LUXEON M/MX FWHM / FWTM: 56.0° / 98.0° Efficiency: 94 % Peak intensity: 0.9 cd/lm LEDs/each optic: 1 Light colour: White Required components:</p> |  |

OPTICAL RESULTS (SIMULATED):



LED CxM-14 (19x19)
FWHM / FWTM 48.0° / 91.0°
Efficiency 88 %
Peak intensity 1 cd/lm
LEDs/each optic 1
Light colour White
Required components:
Bender Wirth: 433 Typ L5



LED CxM-9 (13.5x13.5)
FWHM / FWTM 46.0° / 88.0°
Efficiency 87 %
Peak intensity 1.1 cd/lm
LEDs/each optic 1
Light colour White
Required components:
Bender Wirth: 434 Typ L5



LED COB S-Type (LES 6)
FWHM / FWTM 44.0° / 90.0°
Efficiency 92 %
Peak intensity 1.2 cd/lm
LEDs/each optic 1
Light colour White
Required components:

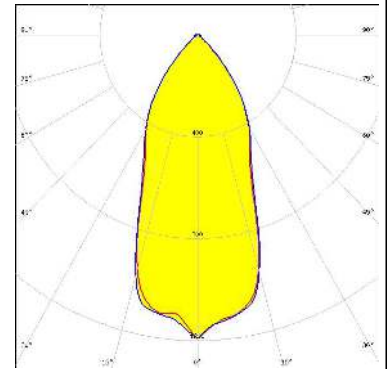

LED Soleriq S9
FWHM / FWTM 45.0° / 87.0°
Efficiency 90 %
Peak intensity 1.2 cd/lm
LEDs/each optic 1
Light colour White
Required components:

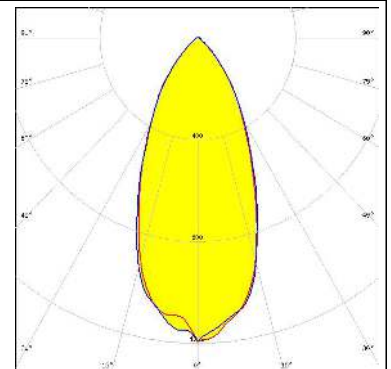

OPTICAL RESULTS (SIMULATED):

SAMSUNG

LED LC010C
 FWHM / FWTM 45.0° / 88.0°
 Efficiency 91 %
 Peak intensity 1.2 cd/lm
 LEDs/each optic 1
 Light colour White
 Required components:
 Bender Wirth: 479 Typ L5

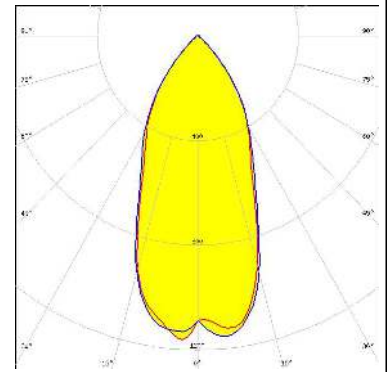

SAMSUNG

LED LC020C
 FWHM / FWTM 45.0° / 86.0°
 Efficiency 89 %
 Peak intensity 1.2 cd/lm
 LEDs/each optic 1
 Light colour White
 Required components:
 Bender Wirth: 479 Typ L5

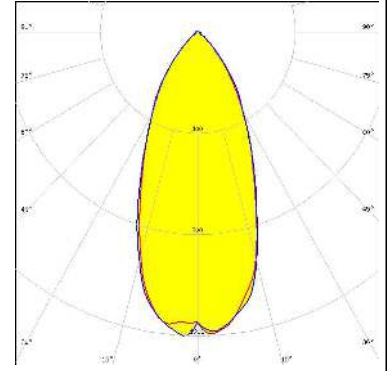

SAMSUNG

LED LC040C
 FWHM / FWTM 45.0° / 86.0°
 Efficiency 88 %
 Peak intensity 1.2 cd/lm
 LEDs/each optic 1
 Light colour White
 Required components:
 Bender Wirth: 479 Typ L5

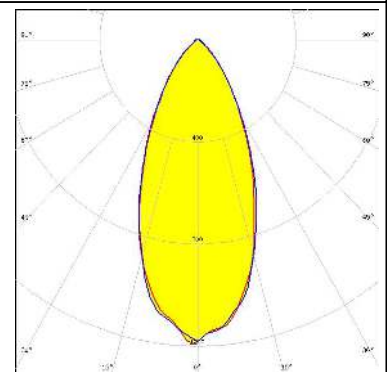

SEMI SEMICONDUCTOR

LED ZC4/6
 FWHM / FWTM 46.0° / 88.0°
 Efficiency 87 %
 Peak intensity 1.1 cd/lm
 LEDs/each optic 1
 Light colour White
 Required components:
 Bender Wirth: 434 Typ L5

GENERAL INFORMATION:

NOTE: The typical beam angle will be changed by different color, chip size and chip position tolerance. The typical total beam angle is the full angle measured where the luminous intensity is half of the peak value.

Due to use of high power COB's with this product, special attention to proper thermal design is highly recommended. LEDiL has no liability for direct, indirect or consecutive damages arising from the LEDiL products being used outside of the recommended temperature range.

MATERIALS:

As part of our continuous research and improvement processes, and to ensure the best possible quality and availability of our products, LEDiL reserves the right to change material grades without notice.

PRODUCT DATA USER AGREEMENT AND DISCLAIMER:

The measured data in the provided downloadable LEDiL Product Datasheets and Mechanical 2D-Drawings is rounded and provided as reference for planning. LEDiL Oy's optical specifications have been verified by conducting performance testing of the products in accordance with the company's quality system. The reported data are averaged results of multiple measurements with typical variation. LEDiL Oy reserves the right to without prior notification make changes and improvements to its products.

LEDiL Oy assumes neither warranty, nor guarantee nor any other liability of any kind for the contents and correctness of the provided data. The provided data has been generated with highest diligence but the provided data may in reality not represent the complete possible variation range of all intrinsic parameters. Therefore, in certain cases a deviation from the provided data could occur.

LEDiL Oy reserves the right to undertake technical changes of its products without further notification which could lead to changes in the provided data. LEDiL Oy assumes no liability of any kind for the possible deviation from any provided data or any other damage resulting from the usage of the provided data.

The user agrees to this disclaimer and user agreement with the download or usage of the provided files.

LEDiL Oy

Joensuunkatu 13
FI-24240 SALO
Finland

LEDiL Inc.

228 West Page Street
Suite D
Sycamore IL 60178
USA

Ledil Optics Technology (Shenzhen) Co., Ltd.

405 , Block B
Casic Motor Building
Shenzhen 518057
P.R.CHINA

Local sales and technical support

[www.ledil.com/
where_to_buy](http://www.ledil.com/where_to_buy)

Shipping locations

Salo, Finland
Hong Kong, China

Distribution Partners

[www.ledil.com/
where_to_buy](http://www.ledil.com/where_to_buy)