

# 8SS

## Sub-miniature Slide Switch

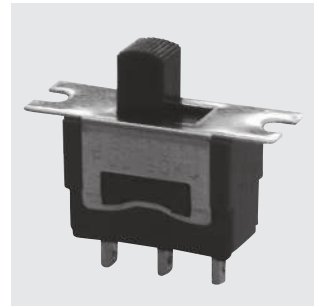

RoHS Compliant

### Specifications

Contact specs.	Silver contacts	
Rating	Max.	125VAC 6A 30VDC 4A
	Min.	5VAC/DC 100mA
Initial contact resistance	10mΩ max. (2~4VDC 1A)	
Initial dielectric strength	1,000VAC 1 minute	
Initial insulation resistance	1,000MΩ min. (500VDC)	
Electrical life	ON — ON	30,000 cycles
	ON — OFF — ON	20,000 cycles
Mechanical life	100,000 cycles	
Operating temperature range	-30~+85°C	
Storage temperature range	-40~+85°C	

### Part Numbering

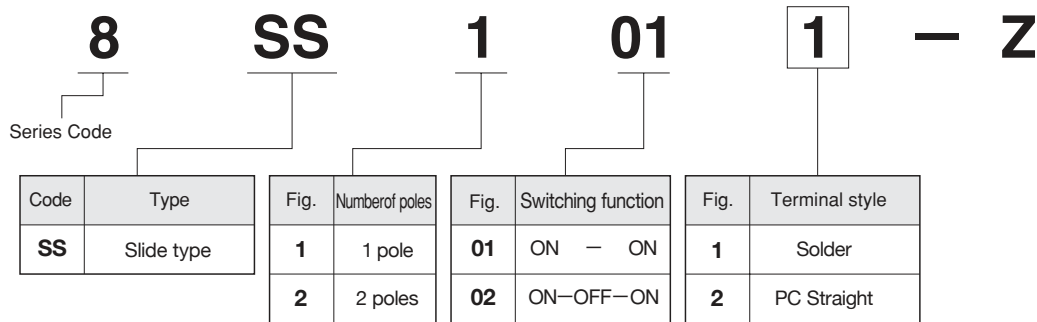

### Terminal Styles

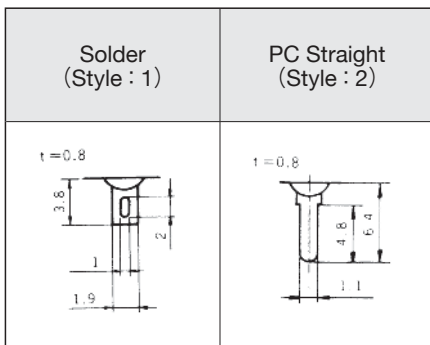

### Panel Cut-Out Dimensions

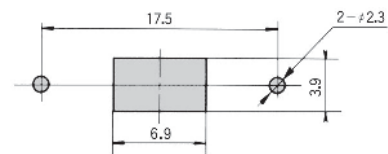

### PC Hole Layouts

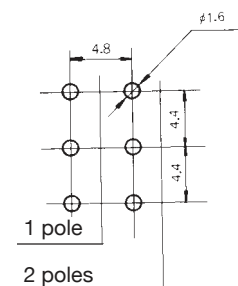

### Packaging Specifications

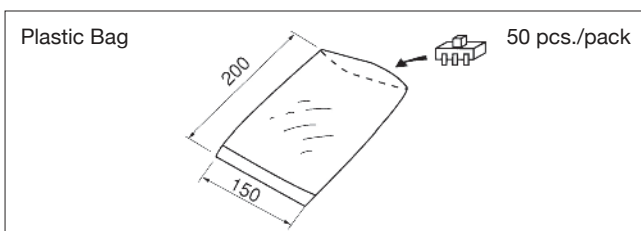

■ SPDT

Solder terminals

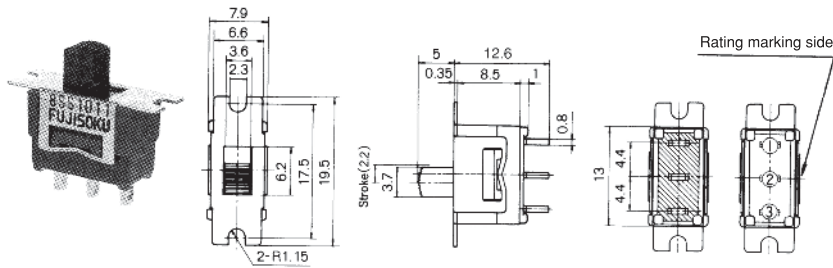

S/D

The terminal numbers are not shown on the switch.

Switching function	Viewed from rating marking side		
Part No.			
8SS1011-Z	ON	—	ON
▲8SS1021-Z	ON	OFF	ON
Connecting terminals	2-1	—	2-3

■ DPDT

Solder terminals

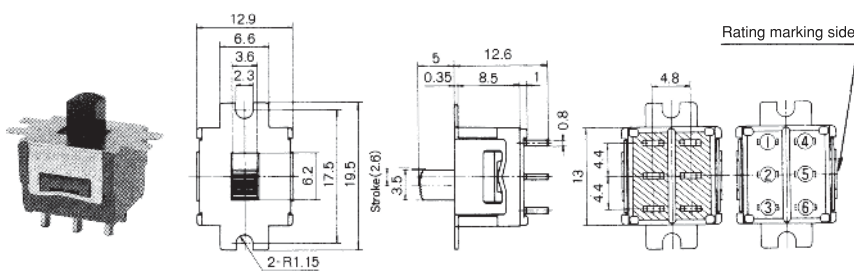

S/D

The terminal numbers are not shown on the switch.

Switching function	Viewed from rating marking side		
Part No.			
8SS2011-Z	ON	—	ON
★8SS2021-Z	ON	OFF	ON
Connecting terminals	2-1 5-4	—	2-3 5-6

■ SPDT

PC Straight

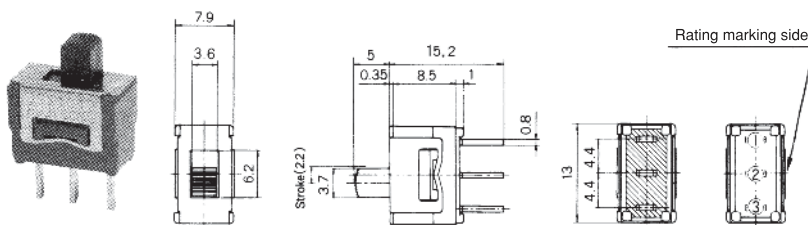

P/C

The terminal numbers are not shown on the switch.

Switching function	Viewed from rating marking side		
Part No.			
8SS1012-Z	ON	—	ON
★8SS1022-Z	ON	OFF	ON
Connecting terminals	2-1	—	2-3

■ DPDT

PC Straight

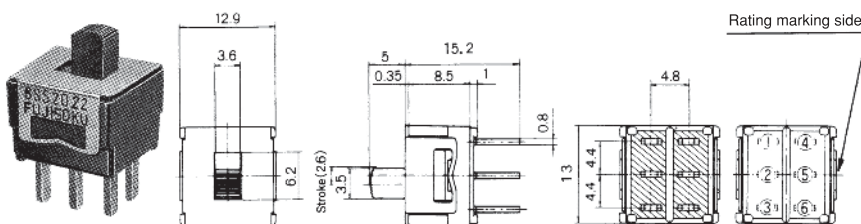

P/C

The terminal numbers are not shown on the switch.

Switching function	Viewed from rating marking side		
Part No.			
8SS2012-Z	ON	—	ON
★8SS2022-Z	ON	OFF	ON
Connecting terminals	2-1 5-4	—	2-3 5-6

★ : Made to order products.  
▲ : Inquiry products.

Not all products are UL-recognized or CSA-certified. Please contact your local Nidec Copal Electronics sales representative.