

## Rochester Electronics Manufactured Components

Rochester branded components are manufactured using either die/wafers purchased from the original suppliers or Rochester wafers recreated from the original IP. All recreations are done with the approval of the OCM.

Parts are tested using original factory test programs or Rochester developed test solutions to guarantee product meets or exceed the OCM data sheet.

## Quality Overview

- ISO-9001
- AS9120 certification
- Qualified Manufacturers List (QML) MIL-PRF-35835
  - Class Q Military
  - Class V Space Level
- Qualified Suppliers List of Distributors (QSLD)
  - Rochester is a critical supplier to DLA and meets all industry and DLA standards.

Rochester Electronics, LLC is committed to supplying products that satisfy customer expectations for quality and are equal to those originally supplied by industry manufacturers.

The original manufacturer's datasheet accompanying this document reflects the performance and specifications of the Rochester manufactured version of this device. Rochester Electronics guarantees the performance of its semiconductor products to the original OEM specifications. 'Typical' values are for reference purposes only. Certain minimum or maximum ratings may be based on product characterization, design, simulation, or sample testing.

# TMC2272A

## Digital Colorspace Converter

### 36 Bit Color, 50 MHz

#### Features

- 50 MHz (20ns) pipelined throughput
- 3 Simultaneous 12-bit input and output channels (64 Giga { $2^{36}$ } colors)
- Two's complement inputs and outputs
- Overflow headroom available in lower resolution
- 10-bit user-defined coefficients
- TTL compatible input and output signals
- Full precision internal calculation
- Output rounding
- On-board coefficient memory
- Submicron CMOS process

#### Description

A 50-MHz, three-channel, 36 bit (three 12-bit components) colorspace converter and color corrector, the TMC2272A uses 9 parallel multipliers to process high-resolution imagery in real time.

The TMC2272A also operates at any slower clock rate and with any smaller data path width, allowing it to handle all broadcast and consumer camera, frame-grabber, encoder/decoder, recorder and monitor applications as well as most electronic imaging applications.

A complete set of three 12-bit samples is processed on every clock cycle, with a five-cycle pipeline latency. Full 23-bit (for each of three components) internal precision is provided

#### Applications

- Translation between component color standards (RGB, YIQ, YUV, etc.)
- Broadcast composite color encoding and decoding (all standards)
- Broadcast composite color standards conversion and transcoding
- Camera tube and monitor phosphor colorimetry correction
- White balancing and color-temperature conversion
- Image capture, processing and storage
- Color matching between systems, cameras and monitors
- Three-dimensional perspective translation

with 10-bit user-defined coefficients. The coefficients may be varied dynamically, with three new coefficients loaded every clock cycle. (The full set of nine can be replaced in three clock cycles.) Rounding to 12 bits per component is performed only at the final output. This allows full accuracy with correct rounding and overflow headroom for applications that require less than 12 bits per component.

The TMC2272A is fabricated in a submicron CMOS process and performance is guaranteed over the full operating temperature range. It is available in a 120-pin Plastic Pin Grid Array (PPGA) package, 120-pin Ceramic Pin Grid Array (CPGA), 120-pin MQFP to PGA package, and 120-pin Plastic Quad FlatPack (PQFP) in three speed grades.

#### Logic Symbol



# Block Diagram

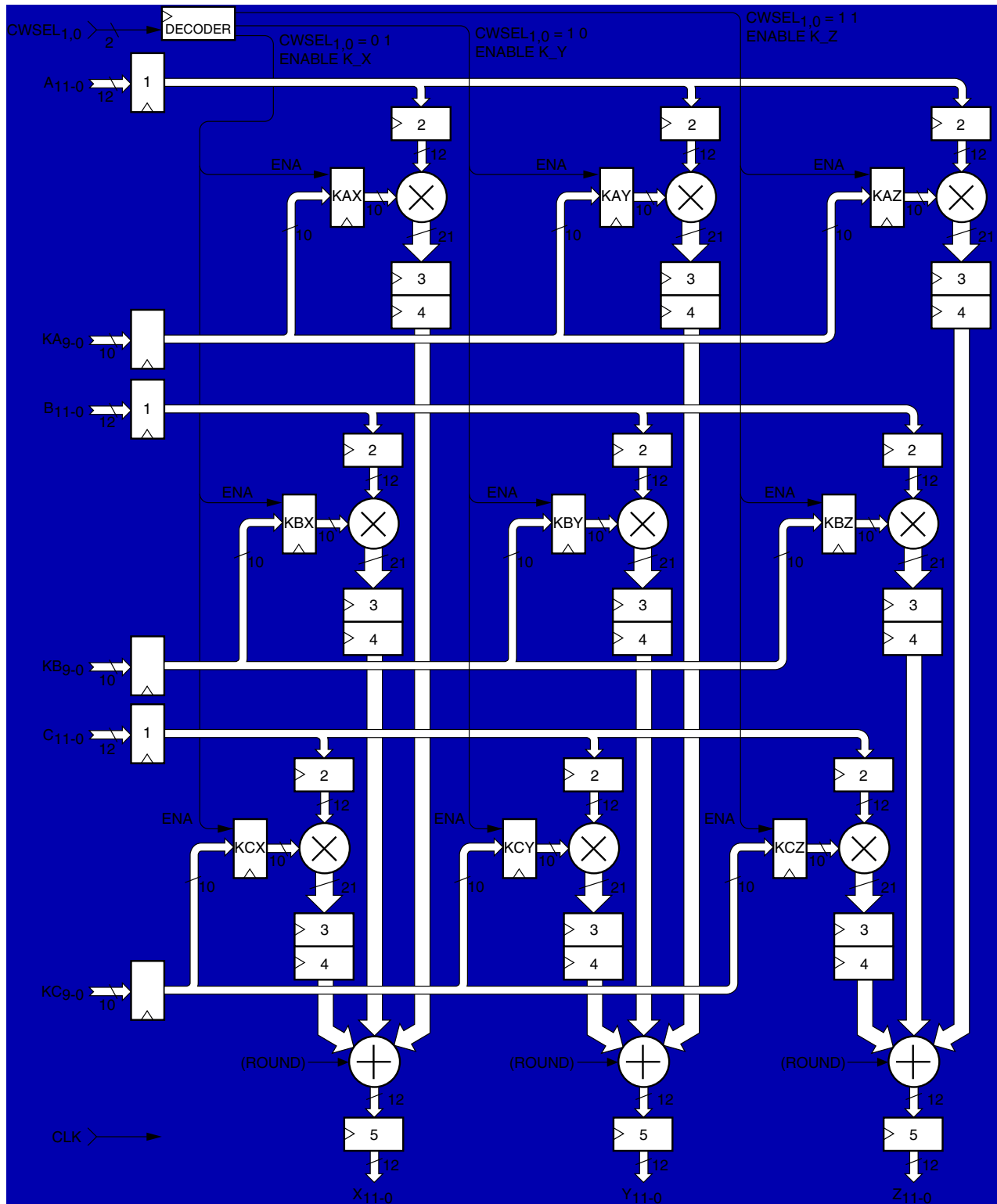

## Functional Description

The TMC2272A is a nine-multiplier array with the internal bus structure and summing adders needed to implement a 3 x 3 matrix multiplier (triple dot product). With a 50MHz guaranteed maximum clock rate, this device offers video and imaging system designers a single-chip solution to numerous common image and signal-processing problems.

The three data input ports (A<sub>11-0</sub>, B<sub>11-0</sub>, C<sub>11-0</sub>) accept 12-bit two's complement integer data, which is also the format for the output ports (X<sub>11-0</sub>, Y<sub>11-0</sub>, Z<sub>11-0</sub>). Other format and path width options are discussed in the numeric format and overflow section. The coefficient input ports (KA, KB, KC) are always 10-bit two's complement fractional. Table 2 details the bit weighting.

Full precision is maintained throughout the TMC2272A. Each output is accurately rounded to 12 bits from the 23 bits entering the final adder.

### Signal Definitions

A(n), B(n), C(n)

Indicates the data word presented to that input port during the specified clock rising edge (n). Applies to input ports A<sub>11-0</sub>, B<sub>11-0</sub>, and C<sub>11-0</sub>.

KAX(n) thru KCZ(n)

Indicates coefficient value stored in the specified one of the nine onboard coefficient registers KAX through KCZ, input during or before the specified clock rising edge (n).

X(n), Y(n), Z(n)

Indicates data available at that output port t<sub>DO</sub> after the specified clock rising edge (n). Applies to output ports X<sub>11-0</sub>, Y<sub>11-0</sub>, and Z<sub>11-0</sub>.

The TMC2272A utilizes six input and output ports to realize a "triple dot product", in which each output is the sum of all three input words, multiplied by the appropriate stored coefficients. The three corresponding sums of products are available at the outputs five clock cycles after the input data are latched, and three new data words rounded to 12-bits are then available every clock cycle. See the Applications Discussion regarding encoded video standard conversion matrices.

$$X(5)=A(1)KAX(1)+B(1)KBX(1)+C(1)KCX(1)$$

$$Y(5)=A(1)KAY(1)+B(1)KBY(1)+C(1)KCY(1)$$

$$Z(5)=A(1)KAZ(1)+B(1)KBZ(1)+C(1)KCZ(1)$$

## Pin Assignments

**120 Pin Plastic Pin Grid Array, H5 Package, 120 Pin Ceramic Pin Grid Array, G1 Package, and 120 Pin MQFP to PPGA, H6 Package**

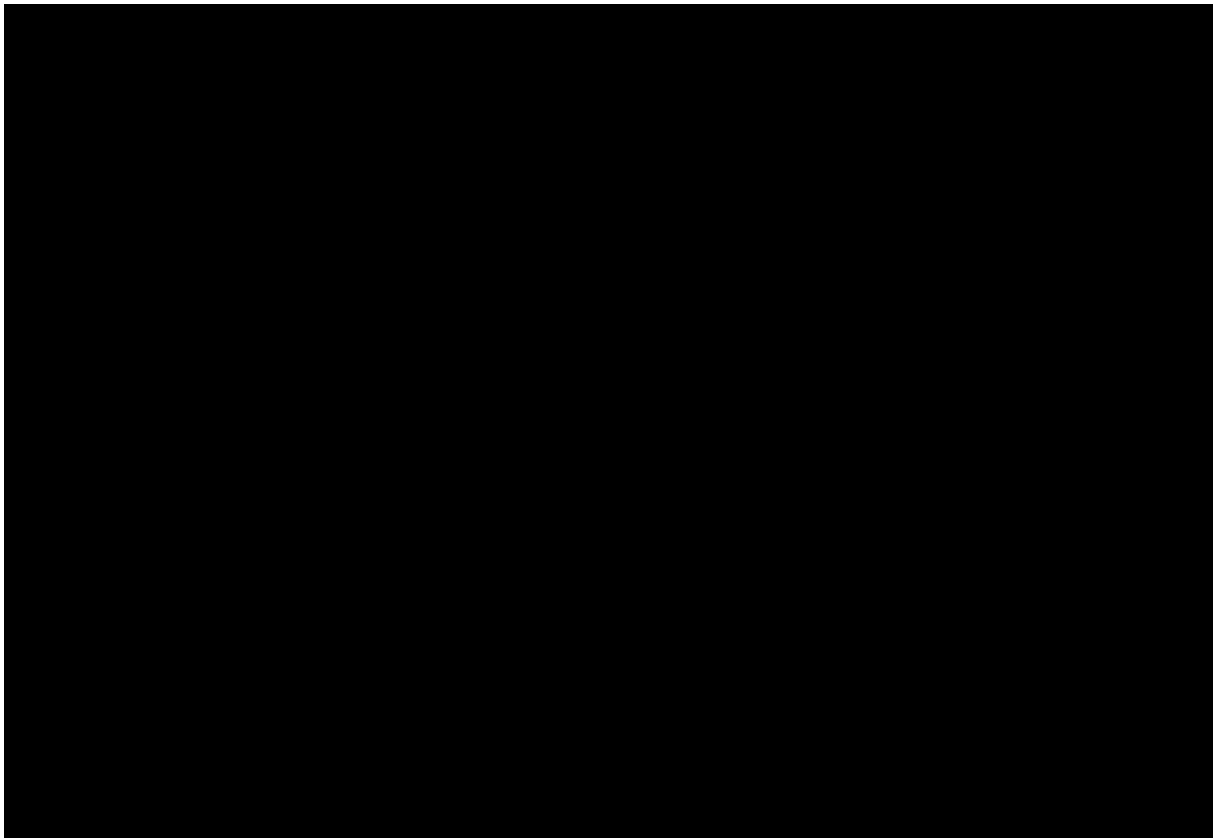

## Pin Assignments (continued)

### 120 Pin Metric Quad Flat Pack (MQFP), KE Package

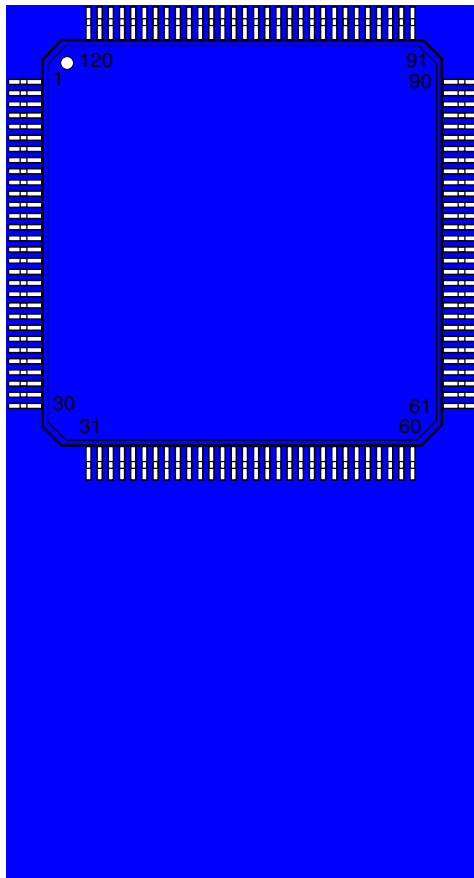

| Pin | Name            | Pin | Name            | Pin | Name               | Pin | Name            |
|-----|-----------------|-----|-----------------|-----|--------------------|-----|-----------------|
| 1   | X6              | 31  | Z6              | 61  | KA1                | 91  | B5              |
| 2   | X5              | 32  | Z7              | 62  | KA2                | 92  | B6              |
| 3   | X4              | 33  | Z8              | 63  | KA3                | 93  | B7              |
| 4   | X3              | 34  | GND             | 64  | KA4                | 94  | B8              |
| 5   | X2              | 35  | Z9              | 65  | KA5                | 95  | B9              |
| 6   | X1              | 36  | Z10             | 66  | KA6                | 96  | B10             |
| 7   | X0              | 37  | Z11             | 67  | KA7                | 97  | B11             |
| 8   | GND             | 38  | KC0             | 68  | KA8                | 98  | C0              |
| 9   | Y11             | 39  | KC1             | 69  | KA9                | 99  | C1              |
| 10  | Y10             | 40  | KC2             | 70  | CWSEL <sub>1</sub> | 100 | C2              |
| 11  | Y9              | 41  | KC3             | 71  | CWSEL <sub>0</sub> | 101 | C3              |
| 12  | V <sub>DD</sub> | 42  | GND             | 72  | GND                | 102 | V <sub>DD</sub> |
| 13  | Y8              | 43  | KC4             | 73  | A0                 | 103 | C4              |
| 14  | Y7              | 44  | KC5             | 74  | A1                 | 104 | C5              |
| 15  | Y6              | 45  | KC6             | 75  | A2                 | 105 | C6              |
| 16  | GND             | 46  | V <sub>DD</sub> | 76  | A3                 | 106 | GND             |
| 17  | Y5              | 47  | KC7             | 77  | A4                 | 107 | C7              |
| 18  | Y4              | 48  | KC8             | 78  | A5                 | 108 | C8              |
| 19  | Y0              | 49  | KC9             | 79  | A6                 | 109 | C9              |
| 20  | V <sub>DD</sub> | 50  | KB0             | 80  | A7                 | 110 | C10             |
| 21  | Y1              | 51  | KB1             | 81  | A8                 | 111 | C11             |
| 22  | Y2              | 52  | KB2             | 82  | A9                 | 112 | GND             |
| 23  | Y3              | 53  | KB3             | 83  | A10                | 113 | GND             |
| 24  | GND             | 54  | KB4             | 84  | A11                | 114 | GND             |
| 25  | Z0              | 55  | KB5             | 85  | B0                 | 115 | X11             |
| 26  | Z1              | 56  | KB6             | 86  | B1                 | 116 | X10             |
| 27  | Z2              | 57  | KB7             | 87  | B2                 | 117 | X9              |
| 28  | Z3              | 58  | KB8             | 88  | CLK                | 118 | V <sub>DD</sub> |
| 29  | Z4              | 59  | KB9             | 89  | B3                 | 119 | X8              |
| 30  | Z5              | 60  | KA0             | 90  | B4                 | 120 | X7              |

## Pin Descriptions

| Pin Name             | CPGA/PPGA/MPGA Pin Number               | KE Pin Number                             | Pin Function Description   |
|----------------------|---|---|--|
| <b>Power</b>         |   |   |  |
| V <sub>DD</sub>      | F3, H3, L7, C8, C4                      | 12, 20, 46, 102, 118                      | <b>Supply Voltage.</b> The TMC2272A operates from a single +5V supply. All pins must be connected.   |
| GND                  | E3, G3, J3, L4, L6, H11, C7, C5, A4, B5 | 8, 16, 24, 34, 42, 72, 106, 112, 113, 114 | <b>Ground</b>  |
| <b>Clock</b>         |   |   |  |
| CLK                  | D11                                     | 88  | <b>System Clock.</b> The TMC2272A operates from a single system clock input. All timing specifications are referenced to the rising edge of clock.   |
| <b>Controls</b>      |   |   |  |
| CWSEL <sub>1,0</sub> | J12, J13                                | 70, 71                                    | <b>Coefficient Write Select.</b> This input selects which three of the 9 coefficient registers, if any, will be updated on the next clock cycle from the KA <sub>9-0</sub> , KB <sub>9-0</sub> , AND KC <sub>9-0</sub> inputs. See Table 4 and the Functional Block Diagram. |

## Pin Descriptions (continued)

| Pin Name          | CPGA/PPGA/<br>MPGA<br>Pin Number                                    | KE Pin Number   | Pin Function Description  |
|-------------------|---|---|---|
| <b>Inputs</b>     |   |   |   |
| A <sub>11-0</sub> | E11, D13, E12,<br>E13, F11, F12,<br>F13, G13, G11,<br>G12, H13, H12 | 84, 83, 82, 81,<br>80, 79, 78, 77,<br>76, 75, 74, 73              | <b>Data Input A.</b> This is one of three 12-bit wide data input ports.   |
| B <sub>11-0</sub> | B10, A11, B11,<br>C10, A12, B12,<br>C11, A13, C12,<br>B13, C13, D12 | 97, 96, 95, 94,<br>93, 92, 91, 90,<br>89, 87, 86, 85              | <b>Data Input B.</b> This is one of three 12-bit wide data input ports.   |
| C <sub>11-0</sub> | A5, C6, B6, A6,<br>A7, B7, A8, B8,<br>A9, B9, A10, C9               | 111, 110, 109,<br>108, 107, 105,<br>104, 103, 101,<br>100, 99, 98 | <b>Data Input C.</b> This is one of three 12-bit wide data input ports.   |
| KA <sub>9-0</sub> | K13, J11, K12,<br>L13, L12, K11,<br>M13, M12, L11,<br>N13           | 69, 68, 67, 66,<br>65, 64, 63, 62,<br>61, 60                      | <b>Coefficient Input KAX, KAY, or KAZ.</b> These are the 10-bit wide coefficient input ports. The value at each of these three inputs will update one coefficient register as selected by the coefficient write select (CWSEL <sub>1-0</sub> ) on the next clock. See Table 1 and the Functional Block Diagram. |
| KB <sub>9-0</sub> | M11, L10, N12,<br>N11, M10, L9,<br>N10, M9, N9, L8                  | 59, 58, 57, 56,<br>55, 54, 53, 52,<br>51, 50                      | <b>Coefficient Input KBX, KBY, OR KBZ.</b> These are the 10-bit wide coefficient input ports. The value at each of these three inputs will update one coefficient register as selected by the coefficient write select (CWSEL <sub>1-0</sub> ) on the next clock. See Table 1 and the Functional Block Diagram. |
| KC <sub>9-0</sub> | M8, N8, N7, M7,<br>N6, M6, N5, M5,<br>N4, L5                        | 49, 48, 47, 45,<br>44, 43, 41, 40,<br>39, 38                      | <b>Coefficient Input KCX, KCY, OR KCZ.</b> These are the 10-bit wide coefficient input ports. The value at each of these three inputs will update one coefficient register as selected by the coefficient write select (CWSEL <sub>1-0</sub> ) on the next clock. See Table 1 and the Functional Block Diagram. |
| <b>Outputs</b>    |   |   |   |
| X <sub>11-0</sub> | B4, A3, A2, B3,<br>A1, C3, B2, B1,<br>D3, C2, C1, D2                | 115, 116, 117,<br>119, 120, 1, 2, 3,<br>4, 5, 6, 7                | <b>Output X.</b> These are the data outputs. Data are available at the 12-bit registered Output Ports X,Y and Z t <sub>DO</sub> after every clock rising edge.  |
| Y <sub>11-0</sub> | D1, E2, E1, F2,<br>F1, G2, G1, H1,<br>K1, J2, J1, H2                | 9, 10, 11, 13, 14,<br>15, 17, 18, 23,<br>22, 21, 19               | <b>Output Y.</b> These are the data outputs. Data are available at the 12-bit registered Output Ports X,Y and Z t <sub>DO</sub> after every clock rising edge.  |
| Z <sub>11-0</sub> | M4, N3, M3, N2,<br>M2, L3, N1, L2,<br>K3, M1, L1, K2                | 37, 36, 35, 33,<br>32, 31, 30, 29,<br>28, 27, 26, 25              | <b>Output Z.</b> These are the data outputs. Data are available at the 12-bit registered Output Ports X,Y and Z t <sub>DO</sub> after every clock rising edge.  |

**Table 1. Coefficient Loading**

|       |                   | CWSEL <sub>1,0</sub> |             |             |             |
|-------|-------------------|----------------------|-------------|-------------|-------------|
|       |                   | 00                   | 01          | 10          | 11          |
| Input | KA <sub>9-0</sub> | Hold<br>All          | Load<br>KAX | Load<br>KAY | Load<br>KAZ |
| Input | KB <sub>9-0</sub> | Hold<br>All          | Load<br>KBX | Load<br>KBY | Load<br>KBZ |
| Input | KC <sub>9-0</sub> | Hold<br>All          | Load<br>KCX | Load<br>KCY | Load<br>KCZ |

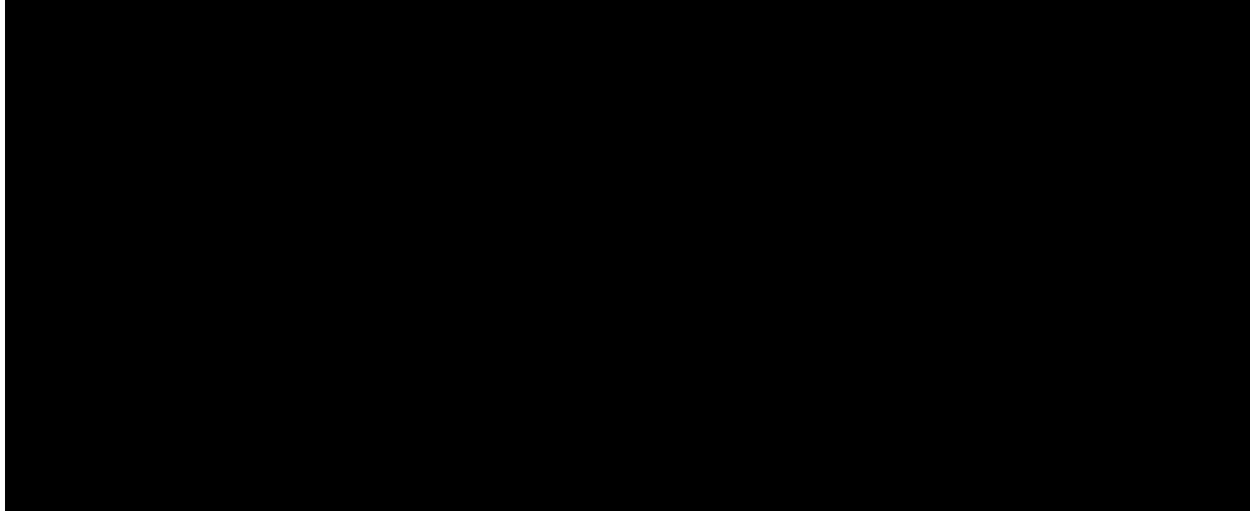

Figure 1. Impulse Response

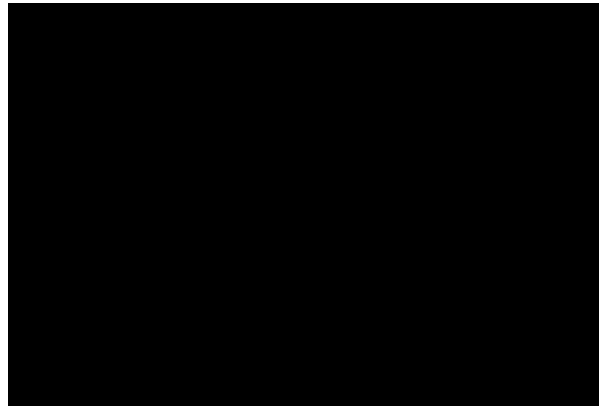

Figure 2. Input/Output Timing

### Numeric Format and Overflow

Table 2 shows the binary weightings of the input and output ports of the TMC2272A. Although the internal sums of products could grow to 23 bits, the outputs X, Y, and Z are rounded to yield 12-bit integer words. Thus the output format is identical to the input data format. Bit weighting is easily adjusted by applying the same scaling correction factor to both input and output data words.

As shown in Table 2, the TMC2272A’s matched input and output data formats accommodate 0dB (unity) gain. Therefore the user must be aware of input conditions that could lead to numeric overflow. Maximum input data and coefficient word sizes must be taken into account with the specific translation performed to ensure that no overflow occurs.

### Use with Fewer than 12 Bits

The TMC2272A can be configured to provide several format and overflow options when used in systems with fewer than 12 bits of resolution. An 8-bit system will be used as an example, however these concepts apply to any other word width.

The most apparent mode of operation is to left justify the incoming data and to ground the unused input LSBs. However, the outputs will still be rounded to the least significant bit of the TMC2272A, having little if any effect on the top 8 bits actually used. Because the TMC2272A carries out all calculations to full precision, the preferred mode of operation is to right justify and sign extend the data as shown in Figure 3. Since all the LSBs are used, the desired output will be rounded correctly, and overflow will be accommodated by bits 7 through 10.

The TMC2272A may also be used in unsigned binary 8-bit systems as shown in Figure 4. Bits 11 through 8 will handle overflow.

In all applications, a digital zero (ground) should be connected to all unused inputs.

**Table 2. Bit Weightings for Input and Output Data Words**

| Bit Weights             | $2^{11}$  | $2^{10}$ | $2^9$    | $2^8$    | $2^7$    | $2^6$    | $2^5$    | $2^4$    | $2^3$    | $2^2$    | $2^1$    | $2^0$ | $\bullet$ | $2^{-1}$ | $2^{-2}$ | $2^{-3}$ | $2^{-4}$ | $2^{-5}$ | $2^{-6}$ | $2^{-7}$ | $2^{-8}$ | $2^{-9}$ |       |  |  |
|-------------------------|-----------|----------|----------|----------|----------|----------|----------|----------|----------|----------|----------|-------|-----------|----------|----------|----------|----------|----------|----------|----------|----------|----------|-------|--|--|
| Inputs                  |           |          |          |          |          |          |          |          |          |          |          |       |           |          |          |          |          |          |          |          |          |          |       |  |  |
| All Modes Data A, B, C  | $-I_{11}$ | $I_{10}$ | $I_9$    | $I_8$    | $I_7$    | $I_6$    | $I_5$    | $I_4$    | $I_3$    | $I_2$    | $I_1$    | $I_0$ | $\Sigma$  |          |          |          |          |          |          |          |          |          |       |  |  |
| Coefficients KA, KB, KC |           |          |          |          |          |          |          |          |          |          |          |       | $-K_9$    | $\Sigma$ | $K_8$    | $K_7$    | $K_6$    | $K_5$    | $K_4$    | $K_3$    | $K_2$    | $K_1$    | $K_0$ |  |  |
| Internal Sum            | $-X_{20}$ | $X_{19}$ | $X_{18}$ | $X_{17}$ | $X_{16}$ | $X_{15}$ | $X_{14}$ | $X_{13}$ | $X_{12}$ | $X_{11}$ | $X_{10}$ | $X_9$ | $\Sigma$  | $X_8$    | $X_7$    | $X_6$    | $X_5$    | $X_4$    | $X_3$    | $X_2$    | $X_1$    | $X_0$    |       |  |  |
| Outputs                 |           |          |          |          |          |          |          |          |          |          |          |       |           |          |          |          |          |          |          |          |          |          |       |  |  |
| X, Y, Z                 | $-O_{11}$ | $O_{10}$ | $O_9$    | $O_8$    | $O_7$    | $O_6$    | $O_5$    | $O_4$    | $O_3$    | $O_2$    | $O_1$    | $O_0$ | $\Sigma$  |          |          |          |          |          |          |          |          |          |       |  |  |

A minus sign indicates a two's complement sign bit.

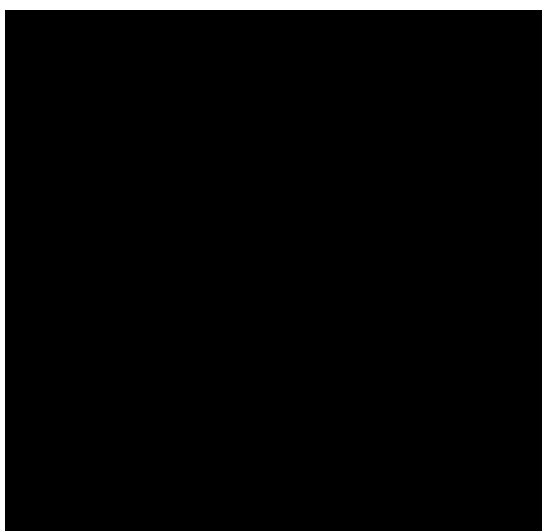

**Figure 3. Two's Complement 8-bit Application**

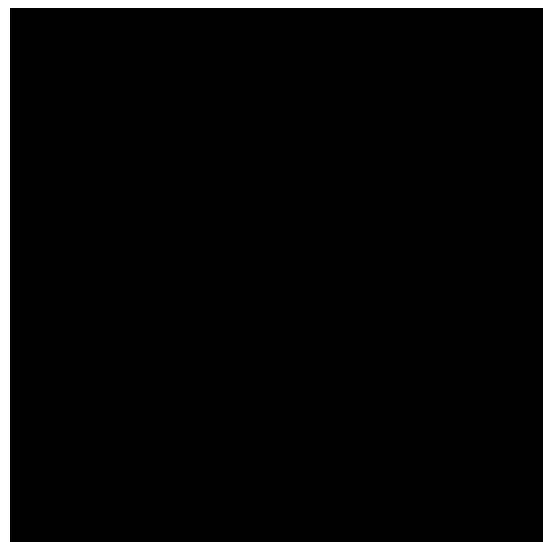

**Figure 4. Binary 8-bit Application**



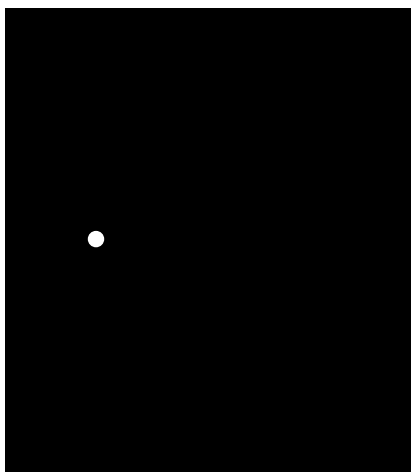

Figure 5. Equivalent Digital Input Circuit

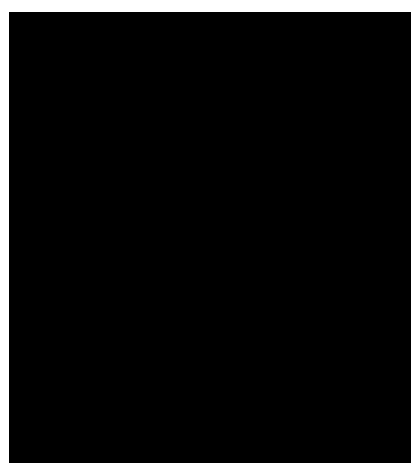

Figure 6. Equivalent Digital Output Circuit

**Absolute Maximum Ratings** (beyond which the device may be damaged)<sup>1</sup>

| Parameter  | Min  | Typ | Max            | Unit |
|--|------|-----|----------------|------|
| Supply Voltage   | -0.5 |     | 7.0            | V    |
| Input Voltage  | -0.5 |     | $V_{DD} + 0.5$ | V    |
| Applied Voltage <sup>2</sup>                                   | -0.5 |     | $V_{DD} + 0.5$ | V    |
| Externally Forced Current <sup>3,4</sup>                       | -3.0 |     | 6.0            | mA   |
| Short Circuit Duration (single output in HIGH state to ground) |      |     | 1              | sec  |
| Operating, Ambient Temperature                                 | -20  |     | 110            | °C   |
| Junction Temperature   |      |     | 140            | °C   |
| Storage Temperature  | -65  |     | 150            | °C   |
| Lead Soldering Temperature (10 seconds)                        |      |     | 300            | °C   |

**Notes:**

1. Absolute maximum ratings are limiting values applied individually while all other parameters are within specified operating conditions. Functional operation under any of these conditions is NOT implied. Performance and reliability are guaranteed only if Operating Conditions are not exceeded.
2. Applied voltage must be current limited to specified range.
3. Forcing voltage must be limited to specified range.
4. Current is specified as conventional current flowing into the device.

## Operating Conditions

| Parameter        |                                | Min        | Nom | Max  | Units |
|------------------|--------------------------------|------------|-----|------|-------|
| V <sub>DD</sub>  | Power Supply Voltage           | 4.75       | 5.0 | 5.25 | V     |
| f <sub>CLK</sub> | Clock Frequency                | TMC2272A   |     | 30   | MHz   |
|                  |                                | TMC2272A-2 |     | 40   | MHz   |
|                  |                                | TMC2272A-3 |     | 50   | MHz   |
| t <sub>PWH</sub> | CLK pulse width, HIGH          | 6          |     |      | ns    |
| t <sub>PWL</sub> | CLK pulse width, LOW           | 8          |     |      | ns    |
| t <sub>S</sub>   | Input Data Setup Time          | 6          |     |      | ns    |
| t <sub>H</sub>   | Input Data Hold Time           | 2          |     |      | ns    |
| V <sub>IH</sub>  | Input Voltage, Logic HIGH      | 2.0        |     |      | V     |
| V <sub>IL</sub>  | Input Voltage, Logic LOW       |            |     | 0.8  | V     |
| I <sub>OH</sub>  | Output Current, Logic HIGH     |            |     | -2.0 | mA    |
| I <sub>OL</sub>  | Output Current, Logic LOW      |            |     | 4.0  | mA    |
| T <sub>A</sub>   | Ambient Temperature, Still Air | 0          |     | 70   | °C    |

## Electrical Characteristics

| Parameter        |   | Conditions  | Min | Typ | Max | Units |
|------------------|---|---|-----|-----|-----|-------|
| I <sub>DD</sub>  | Total Power Supply Current                            | V <sub>DD</sub> = Max, C <sub>LOAD</sub> = 25pF, f <sub>CLK</sub> = Max |     |     |     |       |
|                  |   | TMC2272A  |     |     | 125 | mA    |
|                  |   | TMC2272A-2  |     |     | 140 | mA    |
|                  |   | TMC2272A-3  |     |     | 155 | mA    |
| I <sub>DDU</sub> | Power Supply Current, Unloaded                        | V <sub>DD</sub> = Max, f <sub>CLK</sub> =Max                            |     |     |     |       |
|                  |   | TMC2272A  |     |     | 120 | mA    |
|                  |   | TMC2272A-2  |     |     | 135 | mA    |
|                  |   | TMC2272A-3  |     |     | 150 | mA    |
| I <sub>DDQ</sub> | Power Supply Current, Quiescent                       | V <sub>DD</sub> = Max, CLK = LOW  |     |     | 12  | mA    |
| C <sub>PIN</sub> | I/O Pin Capacitance                                   |   | 5   |     |     | pF    |
| I <sub>IH</sub>  | Input Current, HIGH <sup>1</sup>                      | V <sub>DD</sub> = Max, V <sub>IN</sub> = V <sub>DD</sub>                |     |     | ±5  | μA    |
| I <sub>IL</sub>  | Input Current, LOW <sup>1</sup>                       | V <sub>DD</sub> = Max, V <sub>IN</sub> = 0 V                            |     |     | ±5  | μA    |
| I <sub>OZH</sub> | Hi-Z Output Leakage Current, Output HIGH <sup>2</sup> | V <sub>DD</sub> = Max, V <sub>IN</sub> = V <sub>DD</sub>                |     |     | ±10 | μA    |
| I <sub>OZL</sub> | Hi-Z Output Leakage Current, Output LOW <sup>2</sup>  | V <sub>DD</sub> = Max, V <sub>IN</sub> = 0 V                            |     |     | ±10 | μA    |
| I <sub>OS</sub>  | Short-Circuit Current                                 |   | -20 |     | -80 | mA    |
| V <sub>OH</sub>  | Output Voltage, HIGH                                  | I <sub>OH</sub> = Max, V <sub>DD</sub> = Min                            | 2.4 |     |     | V     |
| V <sub>OL</sub>  | Output Voltage, LOW                                   | I <sub>OL</sub> = Max, V <sub>DD</sub> = Min                            |     |     | 0.4 | V     |

### Notes:

1. Except pins XC<sub>11-0</sub>, YC<sub>11-8</sub>.
2. Pins XC<sub>11-0</sub>, YC<sub>11-8</sub>.

## Switching Characteristics

| Parameter       |                   | Conditions                | Min | Typ | Max | Units |
|-----------------|-------------------|---------------------------|-----|-----|-----|-------|
| t <sub>DO</sub> | Output Delay Time | C <sub>LOAD</sub> = 25 pF |     |     | 15  | ns    |
| t <sub>HO</sub> | Output Hold Time  | C <sub>LOAD</sub> = 25 pF | 3   |     |     | ns    |

## Applications Discussion

The TMC2272A can convert between any two three-coordinate colorspace with the selection of the proper coefficients. Sets of coefficients for some popular colorspace conversions are presented below.

By concatenating coefficient matrices of single transformations, the user can program the TMC2272A to perform compound transforms efficiently. For example, given an RGB input, correction of the relative values of R and B, for

color temperature, conversion to YIQ, modification of contrast by changing Y, and conversion back to RGB can be performed as quickly and easily as any simple transformation. To calculate the final set of coefficients from the coefficients of the individual transformations, the procedure in Figure 7 (concatenation) is used. If more than two matrices are to be combined, the result from the concatenation of the first two matrices is concatenated with the third. If more matrices must be incorporated in the final function, the last step is repeated.

$$\begin{array}{|c|c|c|} \hline \mathbf{A} & \mathbf{B} & \mathbf{C} \\ \hline \mathbf{D} & \mathbf{E} & \mathbf{F} \\ \hline \mathbf{G} & \mathbf{H} & \mathbf{I} \\ \hline \end{array}
 \begin{array}{|c|c|c|} \hline \mathbf{J} & \mathbf{K} & \mathbf{L} \\ \hline \mathbf{M} & \mathbf{N} & \mathbf{O} \\ \hline \mathbf{P} & \mathbf{Q} & \mathbf{R} \\ \hline \end{array}
 =
 \begin{array}{|c|c|c|} \hline \mathbf{AJ + BM + CP} & \mathbf{AK + BN + CQ} & \mathbf{AL + BO + CR} \\ \hline \mathbf{DJ + EM + FP} & \mathbf{DK + EN + FQ} & \mathbf{DL + EO + FR} \\ \hline \mathbf{GJ + HM + IP} & \mathbf{GK + HN + IQ} & \mathbf{GL + HO + IR} \\ \hline \end{array}$$

Figure 7. Concatenation

### Converting from GBR to YC<sub>B</sub>C<sub>R</sub>

With the right coefficients, two external NOT gates, and an external 4-bit half-adder, the TMC2272A can convert video data from 8-bit full-scale (e.g. VGA) GBR components to 10-bit YC<sub>B</sub>C<sub>R</sub> components.

Table 3. 10-bit component formats and inclusive ranges.

| Color Space Term                      | Range  | Format            |
|---------------------------------------|--------|-------------------|
| Y Luminance                           | 64-940 | magnitude         |
| Y' Y - 64                             | 0-876  | magnitude         |
| C <sub>B</sub> Color difference, Blue | 64-960 | magnitude         |
| U' C <sub>B</sub> - 512               | ±448   | 2's comp          |
| C <sub>R</sub> Color difference, Red  | 64-960 | magnitude         |
| V' C <sub>R</sub> - 512               | ±448   | 2's comp          |
| GBR Green, Blue, Red components       | 0-255  | magnitude, 8-bits |

The analog defining equations for 1 Volt luminance and ±0.5 Volt color difference components are:

$$Y = +0.5870(G) + 0.1140(B) + 0.2990(R)$$

$$B - Y = -0.3313(G) + 0.5000(B) - 0.1687(R)$$

$$R - Y = -0.4187(G) - 0.0813(B) + 0.5000(R)$$

To translate these equations into the digital domain, note that the ranges of R, G, and B are 0 to 255 instead of 0 to 1, the range of Y is 64 to 940 instead of 0 to 1, and the ranges of U and V are 64 to 960 instead of +/-0.5:

$$Y = (876/255)(0.587(G)+0.114(B)+0.299(R))+64 = 2.01652(G)+0.39162(B)+1.02715(R) +64$$

$$C_B = (896/255)(0.3313(G)+0.5(B)-0.1687(R))+512 = -1.16397(G)+1.75686(B)-0.59289(R)+512$$

$$C_R = (896/255)(-0.4187(G)-0.0813(B)+0.5(R))+512 = -1.47115(G)-0.28571(B)+1.75686(B)+512$$

Let Y'=Y-64, U'=C<sub>B</sub>-512, and V'=C<sub>R</sub> - 512. The TMC2272A will compute Y', U', and V'. Adding 64 (040<sub>h</sub>) externally to Y' will then yield Y, whereas inverting the most significant bits of U' and V', U'<sub>9</sub> and V'<sub>9</sub>, will yield C<sub>B</sub> and C<sub>R</sub>, respectively. Multiplying the equations immediately above by 128 and rounding each coefficient to the nearest integer yields the recommended set of coefficients for GBR to YUV conversion.

|           |   |                 |                 |                 |             |
|-----------|---|-----------------|-----------------|-----------------|-------------|
| 128 (Y')  | = | 258 (G)<br>102  | +50 (B)<br>032  | +131 (R)<br>083 | dec.<br>hex |
| 128 (U')  | = | -149 (G)<br>36B | +225 (B)<br>0E1 | -76 (R)<br>3B4  | dec<br>hex  |
| 128I (V') | = | -188 (G)<br>344 | -37 (B)<br>3DB  | +225 (R)<br>0E1 | dec.<br>hex |

If the TMC2272A input data alignment for 8-bit GBR is:

|   |   |    |    |    |    |    |    |    |    |   |   |
|---|---|----|----|----|----|----|----|----|----|---|---|
| 0 | 0 | G7 | G6 | G5 | G4 | G3 | G2 | G1 | G0 | 0 | 0 |
| 0 | 0 | B7 | B6 | B5 | B4 | B3 | B2 | B1 | B0 | 0 | 0 |
| 0 | 0 | R7 | R6 | R5 | R4 | R3 | R2 | R1 | R0 | 0 | 0 |

then the output data alignment for 10-bit Y'U'V' is:

|    |    |    |    |    |    |    |    |    |    |    |    |
|----|----|----|----|----|----|----|----|----|----|----|----|
| 0  | 0  | Y9 | Y8 | Y7 | Y6 | Y5 | Y4 | Y3 | Y2 | Y1 | Y0 |
| U9 | U9 | U9 | U8 | U7 | U6 | U5 | U4 | U3 | U2 | U1 | U0 |
| V9 | V9 | V9 | V8 | V7 | V6 | V5 | V4 | V3 | V2 | V1 | V0 |

where the tripled U9 and V9 sign bits denote two's complement sign extensions. The factors of 4 in the input data format and 128 in the equations are absorbed by the internal 9-bit (factor of 512) right-shifting of the emerging results.

At the output of the TMC2272A, invert the most significant bits, U9 and V9, of the chrominance components, and add 1 at Y6 of the luminance to obtain the true CCIR Rec. 601 values.

### Converting from GBR to 8-bit Full-Scale YUV

With the right coefficients and two external NOT gates, the TMC2272A can convert video data from 8-bit full-scale (e.g. VGA) GBR components to 8-bit full-scale YUV components.

**Table 4. 8-bit component formats and inclusive ranges:**

| Color Space Term                  | Range       | Format    |
|-----------------------------------|-------------|-----------|
| Y Luminance                       | 0-255       | magnitude |
| U Color difference, Blue          | 128 to -127 | 2's comp  |
| U' U + 128                        | 0-255       | magnitude |
| V Color difference, Red           | 128 to -127 | 2's comp  |
| V' V + 128                        | 0-255       | magnitude |
| G,B,R Green, Blue, Red components | 0-255       | magnitude |

As in the previous RGB to YC<sub>B</sub>C<sub>R</sub> case, begin with the defining equations, but without the range compensation factors of 255/876 and 255/896:

$$Y = 0.5870 (G) + 0.1140 (B) + 0.2990 (R)$$

$$U = -0.3313 (G) + 0.5000 (B) - 0.1687 (R)$$

$$V = -0.4187 (G) - 0.0813 (B) + 0.5000 (R)$$

The TMC2272A will compute Y, U, and V directly, whereas inverting the most significant bits of U and V, U7 and V7 will yield U' and V', respectively. Multiplying the equations immediately above by 512 and rounding each coefficient to the nearest integer yields the recommended set of coefficients for GBR to YUV conversion.

|         |   |   |         |   |         |   |         |      |
|---------|---|---|---------|---|---------|---|---------|------|
| 512 (Y) | = |   | 301 (G) | + | 58 (B)  | + | 153 (R) | dec. |
|         |   |   | 12D     |   | 03A     |   | 099     | hex  |
| 512 (U) | = | - | 170 (G) | + | 256 (B) | - | 86 (R)  | dec. |
|         |   |   | 356     |   | 100     |   | 3AA     | hex  |
| 512 (V) | = | - | 214 (G) | - | 42 (B)  | + | 256 (R) | dec. |
|         |   |   | 32A     |   | 3D6     |   | 100     | hex  |

If the TMC2272A input data alignment for 8-bit GBR is:

|   |   |   |   |    |    |    |    |    |    |    |    |
|---|---|---|---|----|----|----|----|----|----|----|----|
| 0 | 0 | 0 | 0 | G7 | G6 | G5 | G4 | G3 | G2 | G1 | G0 |
| 0 | 0 | 0 | 0 | B7 | B6 | B5 | B4 | B3 | B2 | B1 | B0 |
| 0 | 0 | 0 | 0 | R7 | R6 | R5 | R4 | R3 | R2 | R1 | R0 |

then the output data alignment for 8-bit YUV is:

|    |    |    |    |    |    |    |    |    |    |    |    |
|----|----|----|----|----|----|----|----|----|----|----|----|
| 0  | 0  | 0  | 0  | Y7 | Y6 | Y5 | Y4 | Y3 | Y2 | Y1 | Y0 |
| U7 | U7 | U7 | U7 | U7 | U6 | U5 | U4 | U3 | U2 | U1 | U0 |
| V7 | V7 | V7 | V7 | V7 | V6 | V5 | V4 | V3 | V2 | V1 | V0 |

where the quintupled U9 and V9 sign bits denote two's complement sign extensions. The factor of 512 in the equations above is absorbed by the internal 9-bit right shift of each emerging result.

At the output of the TMC2272A, invert the most significant bits, U7 and V7, of the chrominance components, to obtain the 8-bit offset format.

**Converting From YC<sub>B</sub>C<sub>R</sub> to GBR**

Following the notation employed earlier, the TMC2272A will be used to convert data in Y'U'V' format into GBR format.

Since Y' = 876, U' = V' = 0, and G = B = R = 255 for saturated white output, every Y' coefficient will be 225/876 = 0.29110. The full analog matrix for Y'U'V' to GBR conversion is:

$$G = 0.29110 (Y') - 0.09794 (U') - 0.20324 (V')$$

$$B = 0.29110 (Y') + 0.50431 (U')$$

$$R = 0.29110 (Y') + 0.39901 (V')$$

Since the largest element is just over 0.5 and the largest permissible coefficient is 511, multiply all elements of the matrix by 512 to obtain the values to load into the TMC2272A.

$$G = \begin{matrix} 149 (Y') & - & 50 (U') & - & 04 (V') \\ 095 & & 3CE & & 398 \end{matrix} \begin{matrix} \text{dec.} \\ \text{hex} \end{matrix}$$

$$B = \begin{matrix} 149 (Y') & + & 258 (U') \\ 095 & & 100 \end{matrix} \begin{matrix} \text{dec.} \\ \text{hex} \end{matrix}$$

$$R = \begin{matrix} 149 (Y') & + & 204 (V') \\ 095 & & 0CC \end{matrix} \begin{matrix} \text{dec.} \\ \text{hex} \end{matrix}$$

Decrease the incoming luminance at the input to the TMC2272A by 64 by adding 1's at positions Y9, Y8, Y7, and Y6. Invert U9 and V9 and their sign extensions, to accommodate CCIR Rec. 601 data. Instead of reducing Y by 64, an alternate is to reduce each of the G, B, and R outputs by (255) (64 / 876) = 19.

For the Y'U'V' to RGB conversion, the TMC2272A input data alignment for 10-bit Y'U'V' is:

|    |    |    |    |    |    |    |    |    |    |    |    |
|----|----|----|----|----|----|----|----|----|----|----|----|
| 0  | 0  | Y9 | Y8 | Y7 | Y6 | Y5 | Y4 | Y3 | Y2 | Y1 | Y0 |
| U9 | U9 | U9 | U8 | U7 | U6 | U5 | U4 | U3 | U2 | U1 | U0 |
| V9 | V9 | V9 | V8 | V7 | V6 | V5 | V4 | V3 | V2 | V1 | V0 |

where the tripled U9 and V9 sign bits denote two's complement sign extensions. The TMC2272A output data alignment for 8-bit GBR is then:

|   |   |   |   |    |    |    |    |    |    |    |    |
|---|---|---|---|----|----|----|----|----|----|----|----|
| 0 | 0 | 0 | 0 | G7 | G6 | G5 | G4 | G3 | G2 | G1 | G0 |
| 0 | 0 | 0 | 0 | B7 | B6 | B5 | B4 | B3 | B2 | B1 | B0 |
| 0 | 0 | 0 | 0 | R7 | R6 | R5 | R4 | R3 | R2 | R1 | R0 |

**Converting From 8-bit Full Scale YUV to GBR**

Following the notation employed earlier, the TMC2272A will be used to convert data in 8-bit YUV format into 8-bit GBR format.

Since  $Y = 256$ ,  $U = V = 0$ , and  $G = B = R = 255$  for saturated white output, every Y coefficient will be  $255 / 255 = 1.0$ . The full matrix for YUV to GBR conversion is:

$$G = 1.0 (Y) \quad -0.3443 (U) \quad -0.7142 (V)$$

$$B = 1.0 (Y) \quad +1.7727 (U)$$

$$R = 1.0 (Y) \quad +1.3965 (V)$$

Since the largest element is over 1.0 and the largest permissible coefficient is 511, multiply all elements of the matrix by 256 to obtain the values to load into the TMC2272A:

$$G = \begin{matrix} 256 (Y') & - 88 (U') & - 83 (V') & \text{dec.} \\ 100 & 3A8 & 349 & \text{hex} \end{matrix}$$

$$B = \begin{matrix} 256 (Y') & + 454 (U') & & \text{dec.} \\ 100 & 1C6 & & \text{hex} \end{matrix}$$

$$R = \begin{matrix} 256 (Y') & + 359 (V') & & \text{dec.} \\ 100 & 167 & & \text{hex} \end{matrix}$$

For the YUV to RGB conversion, the TMC2272A input data alignment for 10-bit Y'U'V' is:

```
0  Y9 Y8 Y7 Y6 Y5 Y4 Y3 Y2 Y1 Y0 0
U9 U9 U8 U7 U6 U4 U4 U3 U2 U1 U0 0
V9 V9 V8 V7 V6 V5 V4 V3 V2 V1 V0 0
```

where the doubled U9 and V9 sign bits denote two's complement sign extensions. The TMC2272A output data alignment for 8-bit GBR is then:

```
0  0  0  0  G7 G6 G5 G4 G3 G2 G1 G0
0  0  0  0  B7 B6 B5 B4 B3 B2 B1 B0
0  0  0  0  R7 R6 R5 R4 R3 R2 R1 R0
```

Note that the inputs have to be doubled because the coefficient gain is 256, whereas the internal gain is  $1 / 512$ , for a net gain of  $1/2$ .

**Table 5. Summary of Colorspace Conversion Coefficients**

| Conversion          | KAX | KAY | KAZ | KBX | KBY | KBZ | KCX | KCY | KCZ |
|---------------------|-----|-----|-----|-----|-----|-----|-----|-----|-----|
| RGB to YUV          | 099 | 3AA | 100 | 12D | 356 | 32A | 03A | 100 | 3D6 |
| RGB to $Y_{C_B}C_R$ | 083 | 3B4 | 0E1 | 102 | 36B | 344 | 032 | 0E1 | 3DB |
| YUV to RGB          | 100 | 100 | 100 | 000 | 3A8 | 1C6 | 167 | 349 | 000 |
| $Y_{C_B}C_R$ to RGB | 149 | 149 | 149 | 000 | 3CE | 102 | 0CC | 398 | 000 |

**Table 6. Conversion Port Assignments and Alignments**

| Port                | AIN          | BIN           | CIN           | XOUT      | YOUT         | ZOUT         |
|---------------------|--------------|---------------|---------------|-----------|--------------|--------------|
| RGB to YUV          | $R_{7-0}$    | $G_{7-0}$     | $B_{7-0}$     | $Y_{7-0}$ | $U_{7-0}(e)$ | $V_{7-0}(e)$ |
| RGB to $Y_{C_B}C_R$ | $R_{7-0}$    | $G_{7-0}$     | $B_{7-0}$     | $Y_{9-0}$ | $U_{9-0}(e)$ | $V_{9-0}(e)$ |
| YUV to RGB          | $Y_{8-1}(e)$ | $U_{8-1}(e)$  | $V_{8-1}(e)$  | $R_{7-0}$ | $G_{7-0}$    | $B_{7-0}$    |
| $Y_{C_B}C_R$ to RGB | $Y_{9-0}$    | $C_{B9-0}(e)$ | $C_{R9-0}(e)$ | $R_{7-0}$ | $G_{7-0}$    | $B_{7-0}$    |

Where  $X_{Y-0}$  denotes right-justified, (e) denotes sign extension, and  $X_{Y-1}$  denotes shifted one bit leftward from a right-justified position.

### HSV (HSI) Format Conversions

HSV (or HSI) refers to Hue (color), Saturation (vividness), and Value (intensity or brightness), quantities which are directly related to the human perception of light and color. The V (or I) levels are simply the Y (or luminance) levels. Hue and Saturation are derived from the R-Y and B-Y color difference values of a signal.

HSV Calculations:

$$\text{Value (V)} = \text{Intensity (I)} = Y$$

$$\text{Hue (H)} = \text{Arctan} (B-Y/R-Y)$$

$$\text{Saturation (S)} = \sqrt{(R-Y)^2 + (B-Y)^2}$$

$$R-Y = S * \cos(H)$$

$$B-Y = S * \sin(H)$$

One may use two 64Kx8 ROM look-up-tables to calculate Hue and Saturation from R-Y and B-Y in an 8-bit system. However, the finite size of this LUT may limit performance, especially if the TMC2272A's full precision is used. The TMC2330A, developed to translate between rectangular and polar coordinates, can perform the trigonometric transformations to 16 bit precision at 50MHz. These calculations are the same as required in HSV calculations. A 4 Gigabyte x 32 bit LUT can achieve the same accuracy and precision as the TMC2330A, if it is programmed correctly.

To convert between Y, R-Y, B-Y and HSV, the TMC2272A isn't needed at all; simply use the TMC2330A. To convert between HSV and any other format, use the TMC2330A to translate between HSV and Y, R-Y, B-Y, and use the TMC2272A to translate between Y, R-Y, B-Y and the other format. See Figures 8 and 9.

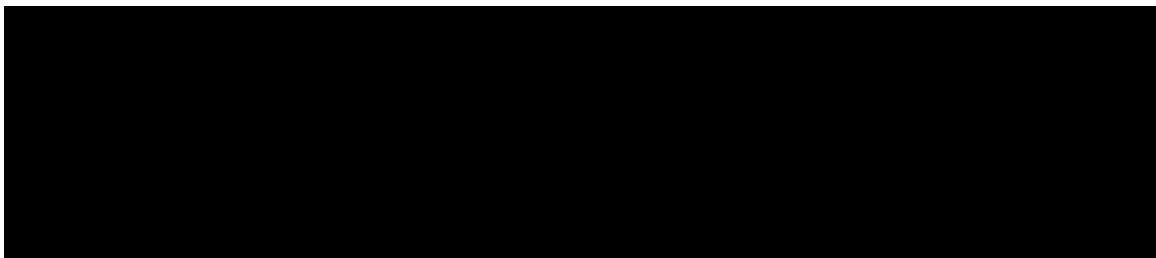

**Notes:**

1. Connect TMC2272A MSBs (Bits 11) to TMC2330A MSBs (Bits 15) and also to TMC2330A Bits 14-11. Connect TMC2272A LSBs (Bits 10-0) to TMC2330A LSBs (Bits 10-0). TMC2330A output bits 14-11 are overflow.
2. TMC2272A  $Y_{11-0}$  outputs should not be confused with the designation "Y" used to signify the intensity components. The assignment of components to TMC2272A inputs and outputs may be altered through the selection of appropriate coefficients.

**Figure 8. Conversion to HSV**

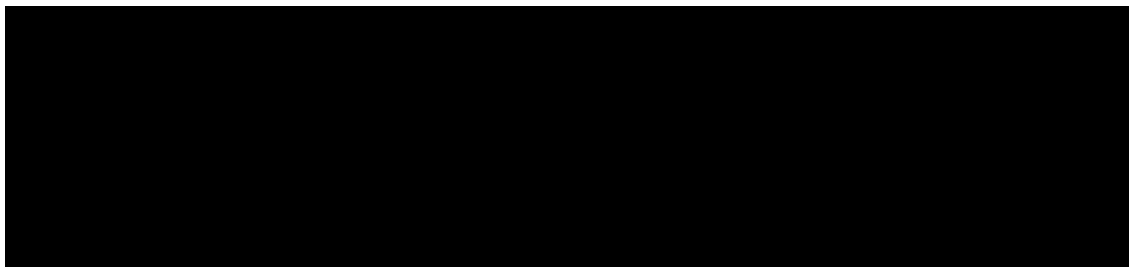

**Notes:**

1. Connect input MSBs (Bits 11) to TMC2330A MSBs (Bits 15) and also to TMC2330A Bits 14-11. Connect input LSBs (Bits 10-0) to TMC2330A LSBs (Bits 10-0).
2. TMC2272A  $Y_{11-0}$  outputs should not be confused with the designation "Y" used for an intensity component. Component assignment depends on the coefficient used.

**Figure 9. Conversion from HSV**

### Input Interpolation/Output Decimation and Filtering

In some applications the two color-difference signals (R-Y/B-Y or Cr/Cb, for example) are transmitted at one-half the rate of the luminance (Y) signal. These two color-difference signals are often multiplexed to one signal which is at the same sample rate as the luminance signal.

In many applications, if the color difference signals are already band-limited, it is satisfactory to use the same color difference sample for each two luminance samples. Little improvement is obtained with a simple averaging  $([A+B])/2$  interpolation filter. If the color difference signal is not band-limited, either of these two methods may yield unsatisfactory results due to aliasing. In this case, a Fairchild TMC2242B digital low-pass (half-band) interpolating filter will correctly band-limit each color difference signal as it is interpolated. See Figure 10.

The same methods are used to decimate the color difference outputs. Simple decimation by removing every other sample of color information may yield unsatisfactory results due to aliasing. This is a problem because the color difference signals have not been transformed with the higher-bandwidth luminance signals and therefore have higher bandwidths than they had before the transform. The best performance is

obtained by using a precise low-pass (half-band) decimation filter such as the TMC2242B to remove aliasing components. See Figure 11.

The TMC2242B is a bi-directional, selectable rate filter/interpolator/decimator.

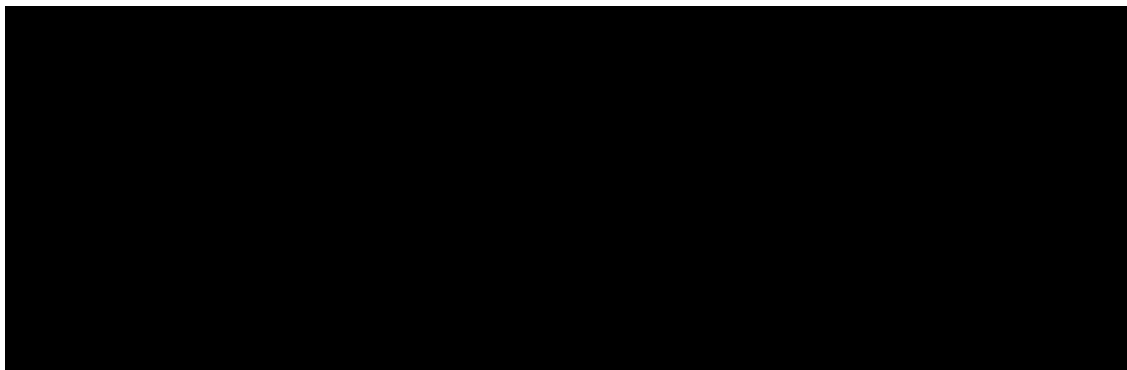

**Notes:**

1. Width of input paths will vary with source.
2. See TMC2242B Datasheet for further information.

**Figure 10. Input Interpolation and Filtering**

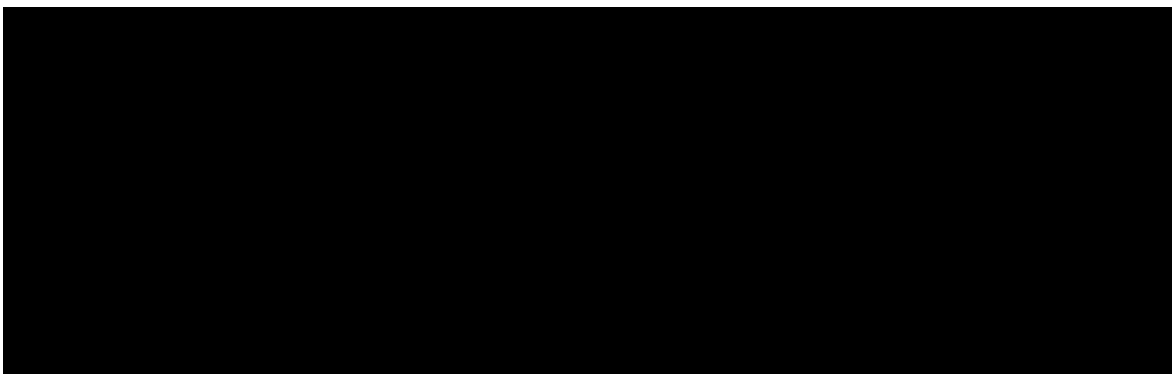

**Figure 11. Output Decimation and Filtering**

## Related Products

- TMC1175 8 bit 40 Msps A/D Converter
- TMC2301 Image Resampling Sequencer
- TMC2302A Image Manipulation Sequencer
- TMC2249A Video Mixer
- TMC2242B Half-Band Filter
- TMC2330A Coordinate Transformer



## Mechanical Dimensions

### 120-Lead CPGA Package Outline

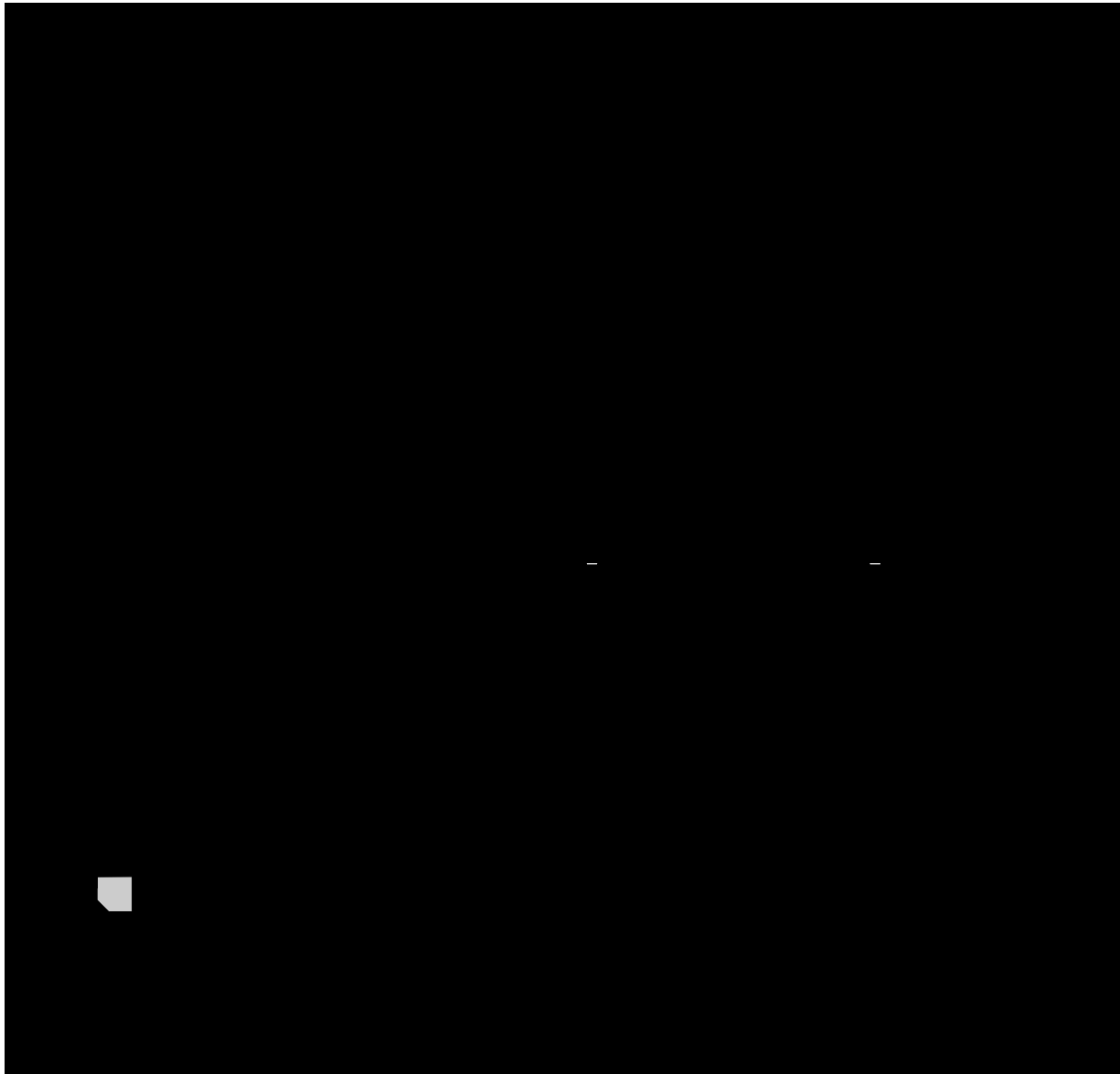

## Mechanical Dimensions

### 120-Lead PPGA Package

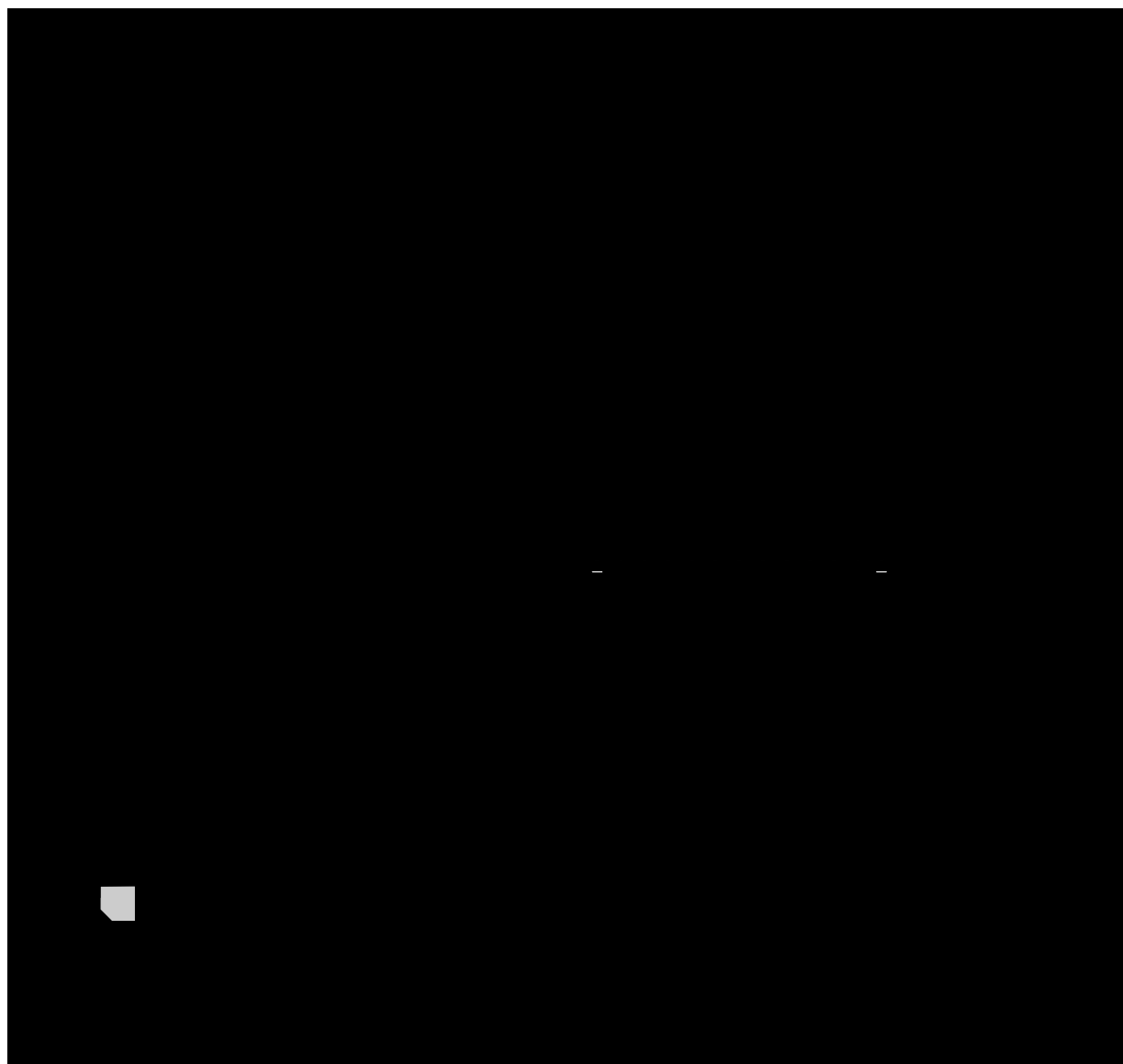

## Mechanical Dimensions

### 120-Lead Metric Quad Flat Package to Pin Grid Array Package (MPGA)

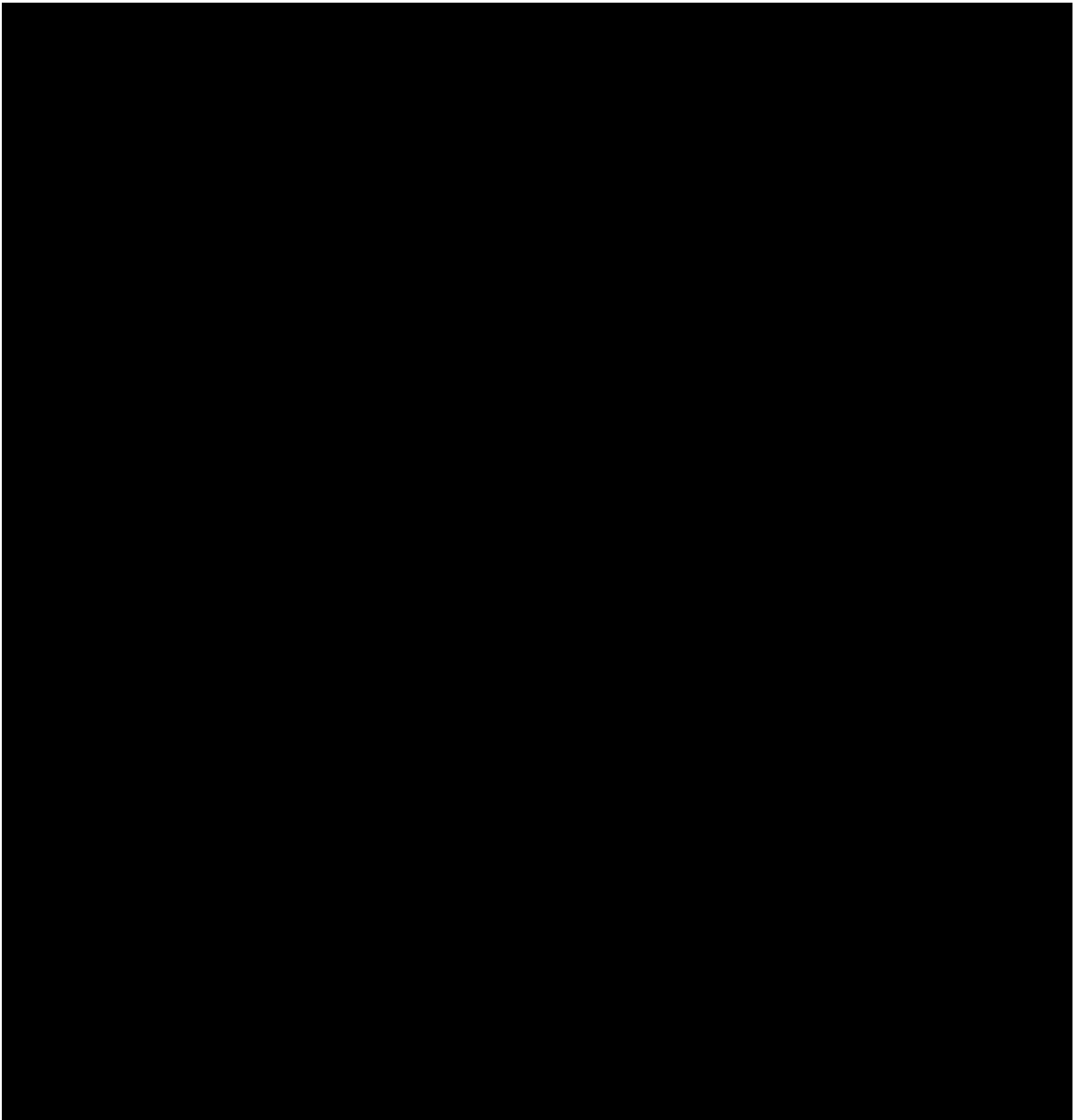

# Mechanical Dimensions

## 120-Lead MQFP Package

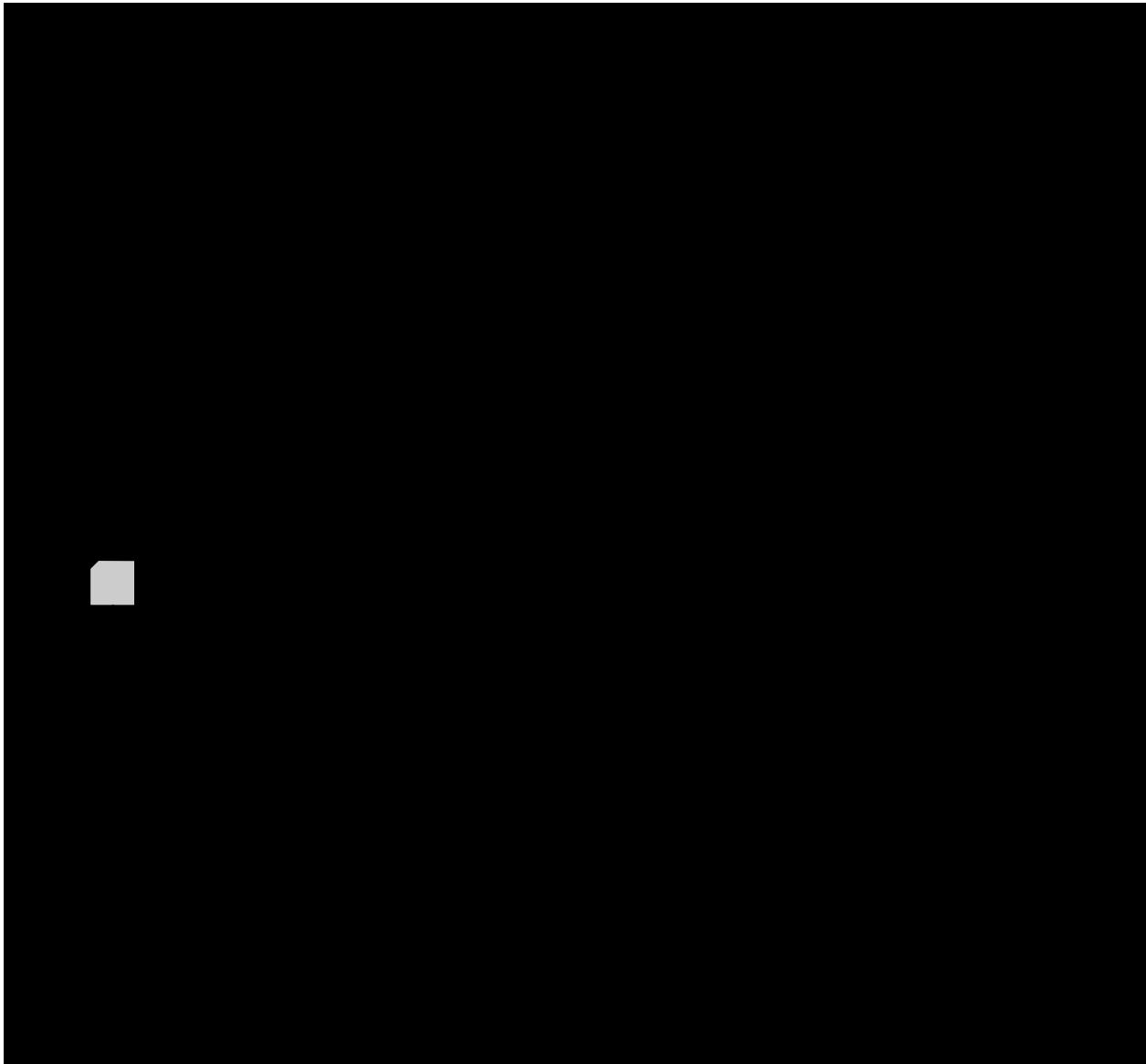

## Ordering Information

| Product Number | Temperature Range | Speed Grade | Screening  | Package   | Package Marking |
|----------------|-------------------|-------------|------------|---|-----------------|
| TMC2272AG1C    | 0°C to 70°C       | 30 MHz      | Commercial | 120 Pin Ceramic Pin Grid Array                  | 2272AG1C        |
| TMC2272AG1C2   | 0°C to 70°C       | 40 MHz      | Commercial | 120 Pin Ceramic Pin Grid Array                  | 2272AG1C2       |
| TMC2272AG1C3   | 0°C to 70°C       | 50 MHz      | Commercial | 120 Pin Ceramic Pin Grid Array                  | 2272AG1C3       |
| TMC2272AH5C    | 0°C to 70°C       | 30 MHz      | Commercial | 120 Pin Plastic Pin Grid Array                  | 2272AH5C        |
| TMC2272AH5C2   | 0°C to 70°C       | 40 MHz      | Commercial | 120 Pin Plastic Pin Grid Array                  | 2272AH5C2       |
| TMC2272AH5C3   | 0°C to 70°C       | 50 MHz      | Commercial | 120 Pin Plastic Pin Grid Array                  | 2272AH5C3       |
| TMC2272AH6C    | 0°C to 70°C       | 30 MHz      | Commercial | 120 Lead Metric Quad Flatpack to Pin Grid Array | N/A             |
| TMC2272AH6C2   | 0°C to 70°C       | 40 MHz      | Commercial | 120 Lead Metric Quad Flatpack to Pin Grid Array | N/A             |
| TMC2272AH6C3   | 0°C to 70°C       | 50 MHz      | Commercial | 120 Lead Metric Quad Flatpack to Pin Grid Array | N/A             |
| TMC2272AKEC    | 0°C to 70°C       | 30 MHz      | Commercial | 120 Lead Plastic Quad Flatpack                  | 2272AKEC        |
| TMC2272AKEC2   | 0°C to 70°C       | 40 MHz      | Commercial | 120 Lead Plastic Quad Flatpack                  | 2272AKEC2       |
| TMC2272AKEC3   | 0°C to 70°C       | 50 MHz      | Commercial | 120 Lead Plastic Quad Flatpack                  | 2272AKEC3       |

### LIFE SUPPORT POLICY

FAIRCHILD'S PRODUCTS ARE NOT AUTHORIZED FOR USE AS CRITICAL COMPONENTS IN LIFE SUPPORT DEVICES OR SYSTEMS WITHOUT THE EXPRESS WRITTEN APPROVAL OF THE PRESIDENT OF FAIRCHILD SEMICONDUCTOR CORPORATION. As used herein:

1. Life support devices or systems are devices or systems which, (a) are intended for surgical implant into the body, or (b) support or sustain life, and (c) whose failure to perform when properly used in accordance with instructions for use provided in the labeling, can be reasonably expected to result in a significant injury of the user.
2. A critical component in any component of a life support device or system whose failure to perform can be reasonably expected to cause the failure of the life support device or system, or to affect its safety or effectiveness.