



# PM-148/883

## QUAD 741 OPERATIONAL AMPLIFIER

Precision Monolithics Inc.

### 1.0 SCOPE

This specification covers the detail requirements for a quad 741 operational amplifier.

It is highly recommended that this data sheet be used as a baseline for new military or aerospace spec control drawings.

### 1.2 Part Number. The complete part numbers per Table I of this specification follow:

<u>Device</u>	<u>Part Number</u>	<u>Package</u>
---------------	--------------------	----------------

**NO LONGER OFFERED AS STANDARD PRODUCT**

### 1.2.3 Case Outline.

<u>Letter</u>	<u>Case Outline (Lead finish per MIL-M-38510)</u>
Y	14-lead ceramic dual-in-line package (CERDIP)

### 1.3 Absolute Maximum Ratings. ( $T_A = 25^\circ\text{C}$ , unless otherwise noted)

Supply Voltage.....	$\pm 22\text{V}$
Differential Input Voltage.....	$\pm 44\text{V}$
Input Voltage.....	$\pm 22\text{V}$
Output Short-Circuit Duration.....	Indefinite
Power Dissipation ( $P_D$ at $25^\circ\text{C}$ ).....	900mW
Maximum Junction Temperature ( $T_J$ ).....	$+150^\circ\text{C}$
Operating Temperature Range.....	$-55^\circ\text{C}$ to $+125^\circ\text{C}$
Storage Temperature Range.....	$-65^\circ\text{C}$ to $+150^\circ\text{C}$
Lead Temperature (Soldering, 60 sec).....	$+300^\circ\text{C}$

#### NOTES:

- Any of the amplifier outputs can be shorted to ground indefinitely; however, more than one should not be simultaneously shorted as the maximum junction temperature will be exceeded.

### 1.5 Thermal Characteristics:

Thermal Resistance, CERDIP (Z) package:

Junction-to-Case ( $\theta_{JC}$ ) =  $29^\circ\text{C/W MAX}$

Junction-to Ambient ( $\theta_{JA}$ ) =  $100^\circ\text{C/W MAX}$

January 1988



**TABLE 1**

$V_S = \pm 15V$ ;  $R_S = 50\Omega$ ;  $V_{CM} = 0V$ ;  $T_A = 25^\circ C$  unless otherwise specified.

Characteristics	Symbol	Special Conditions	PM-148/883		Units
			LIMITS X		
			Min	Max	
Input Offset Voltage	$V_{OS}$	$R_S \leq 10k\Omega$	-	2.5	mV
		$-55^\circ C \leq T_A \leq +125^\circ C$	-	6.0	mV
Input Offset Current	$I_{OS}$		-	10	nA
		$-55^\circ C \leq T_A \leq +125^\circ C$	-	25	nA
Input Bias Current	$I_B$		-	$\pm 75$	nA
		$-55^\circ C \leq T_A \leq +125^\circ C$	-	$\pm 100$	nA
Input Voltage Range (Note 1)	IVR	$-55^\circ C \leq T_A \leq +125^\circ C$	$\pm 12$	-	V
Common-Mode Rejection	CMR	$V_{CM} = IVR = \pm 12V$	80	-	dB
		$R_S \leq 10k\Omega$ $-55^\circ C \leq T_A \leq +125^\circ C$			
Power Supply Rejection	PSR	$V_S = \pm 13.5V$ to $\pm 16.5V$ $R_S \leq 10k\Omega$	85	-	dB
		$V_S = \pm 13.5V$ to $\pm 16.5V$ $R_S \leq 10k\Omega$ $-55^\circ C \leq T_A \leq +125^\circ C$	80	-	dB
Output Voltage Swing	$V_O$	$R_L = 10k\Omega$ $-55^\circ C \leq T_A \leq +125^\circ C$	$\pm 12.0$	-	V
		$R_L = 2k\Omega$	$\pm 11.0$	-	V
		$R_L = 2k\Omega$ $-55^\circ C \leq T_A \leq +125^\circ C$	$\pm 10.0$	-	V
Large-Signal Voltage Gain	$A_{VO}$	$V_O = \pm 10V, R_L \geq 2k\Omega$	50	-	V/mV
		$V_O = \pm 10V, R_L \geq 2k\Omega$ $-55^\circ C \leq T_A \leq +125^\circ C$	25	-	V/mV
Supply Current (All Four Amplifiers)	$I_{SY}$	$+25^\circ C \leq T_A \leq +125^\circ C$	-	3.6	mA
		$T_A \geq -55^\circ C$	-	4.5	mA

OPERATIONAL AMPLIFIERS





**TABLE 1 (Continued)**

$V_S = \pm 15V$ ;  $R_S = 50\Omega$ ;  $V_{CM} = 0V$ ;  $T_A = 25^\circ C$  unless otherwise specified.

Characteristics	Symbol	Special Conditions	PM-148/883		Units
			LIMITS X		
			Min	Max	
<b>Input Resistance</b>					
<b>Differential-Mode</b>	$R_{IN}$		0.8	-	M $\Omega$
<b>(Note 2)</b>					

**NOTES:**

1. IVR is defined as the  $V_{CM}$  range used for the CMR test.
2.  $R_{IN}$  is derived from  $I_B$  by the relationship  $R_{IN} = \frac{4kT}{qI_B}$ , where  $\frac{kT}{q} = 0.026V @ +25^\circ C$



**TABLE 2**

**PM-148/883**

**Electrical Test Requirements  
For Class B Devices**

MIL-STD-883 Test Requirements	Subgroups (see Table 3)
Interim Electrical Parameters (pre Burn-In)	1
Final Electrical Test Parameters	1*, 2, 3, 4, 5, 6
Group A Test Requirements	1, 2, 3, 4, 5, 6

\* PDA applies to Subgroup 1 only.  
No other Subgroups are included in PDA.



**TABLE 3**

**Group A Inspection**

$V_{CM} = 0V$ ;  $R_S = 50\Omega$ ;  $V_S = \pm 15V$ ;  $T_A = T_J$  unless otherwise specified.

Subgroup	Symbol	Special Conditions	PM-148/883 LIMITS X		Units
			Min	Max	
Subgroup 1 $T_A = +25^\circ C$	$V_{OS}$	$R_S = 50\Omega, 10k\Omega$	--	2.5	mV
	$I_{OS}$		--	10	nA
	$I_B$		--	$\pm 75$	nA
	CMR	$V_{CM} = \pm 12V$ ; $R_S = 50\Omega, 10k\Omega$	80	--	dB
	PSR	$V_S = \pm 13.5V, \pm 16.5V$ $R_S = 50\Omega, 10k\Omega$	85	--	dB
	$I_{SY}$		--	3.6	mA
Subgroup 2 $T_A = +125^\circ C$	$V_{OS}$	$R_S = 50\Omega, 10k\Omega$	--	6.0	mV
	$I_{OS}$		--	25	nA
	$I_B$		--	$\pm 100$	nA
	CMR	$V_{CM} = \pm 12V$ ; $R_S = 50\Omega, 10k\Omega$	80	--	dB
	PSR	$V_S = \pm 13.5V, \pm 16.5V$ $R_S = 50\Omega, 10k\Omega$	80	--	dB
	$I_{SY}$		--	3.6	mA
Subgroup 3	$I_{SY}$		--	4.5	mA
$T_A = -55^\circ C$	All remaining Tests, Limits and Conditions are the same as for Subgroup 2.				
Subgroup 4 $T_A = +25^\circ C$	$V_O$	$R_L = 10k\Omega$	$\pm 12$	--	V
		$R_L = 2k\Omega$	$\pm 11$	--	V
	$A_{VO}$	$V_{OUT} = \pm 10V, R_L = 2k\Omega$	50	--	V/mV



**TABLE 3**

**Group A Inspection (Continued)**

$V_{CM} = 0V$ ;  $R_S = 50\Omega$ ;  $V_S = \pm 15V$ ;  $T_A = T_J$  unless otherwise specified.

Subgroup	Symbol	Special Conditions	PM-148/883		Units
			LIMITS X		
			Min	Max	
Subgroup 5	$V_O$	$R_L = 10k\Omega$	$\pm 12$	—	V
		$R_L = 2k\Omega$	$\pm 10$		
$T_A = +125^\circ C$	$A_{VO}$	$V_{OUT} = \pm 10V, R_L = 2k\Omega$	25	—	V/mV
Subgroup 6		All Tests, Limits and Conditions are the same as for Subgroup 5.			
$T_A = -55^\circ C$					

5

OPERATIONAL AMPLIFIERS



**3.2.1 Simplified Schematic and Pin Connections.**

(One of Four Amplifiers)

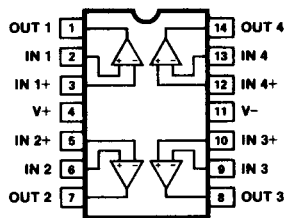
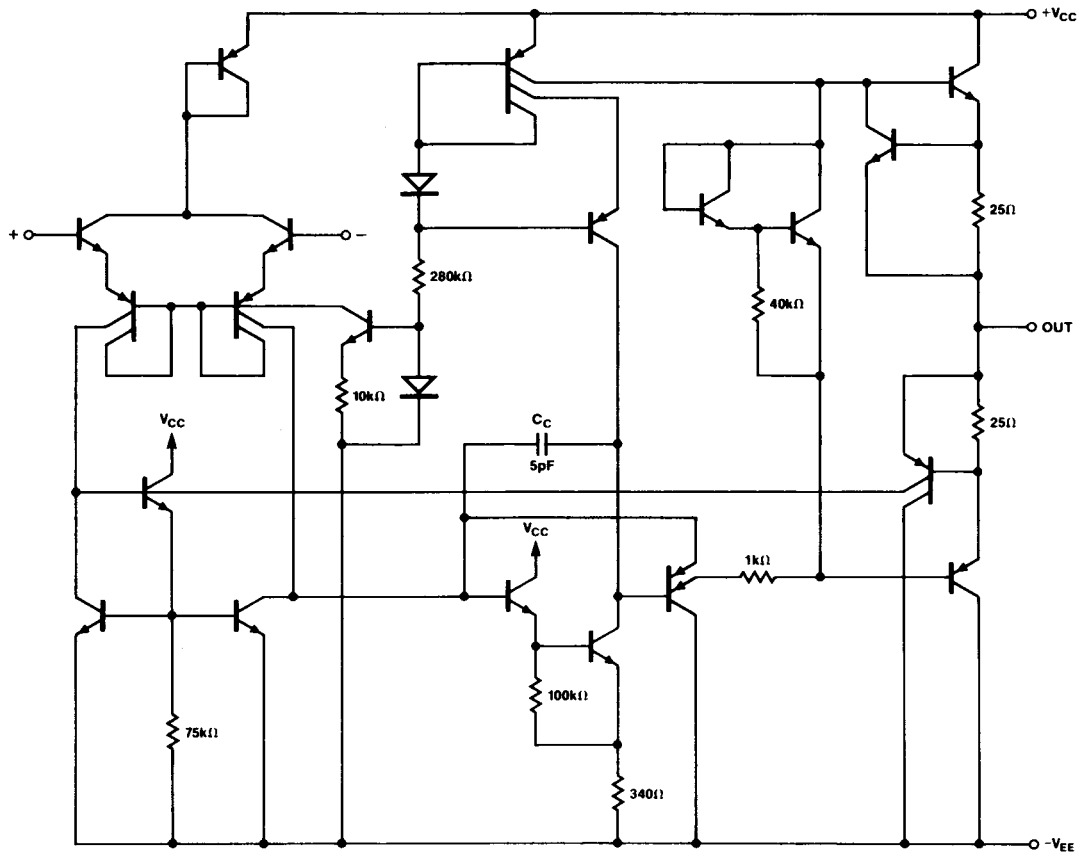

**14-PIN HERMETIC DIP  
(Y-Suffix)**



3.2.4 Microcircuit Group Assignment. This microcircuit is covered by microcircuit group 49.

4.2 Life Test/Burn-In Circuit.

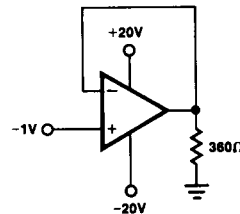
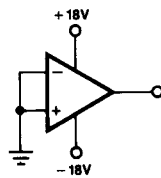
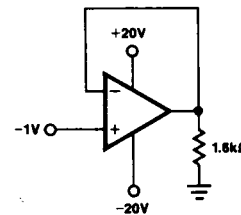
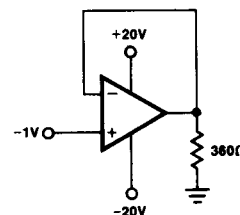
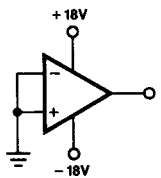
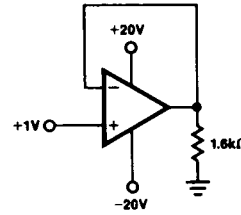
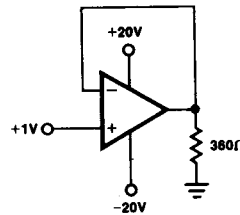
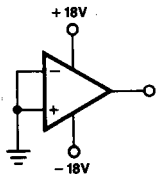
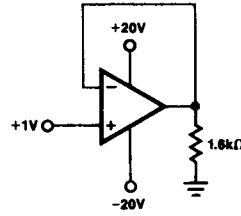
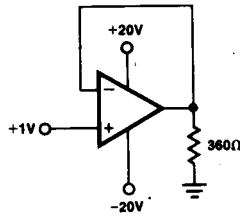
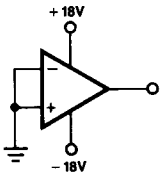

(Alternate)

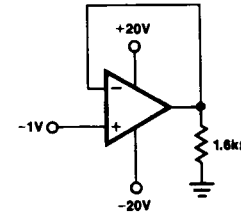

(Alternate)

5  
OPERATIONAL AMPLIFIERS