

RECOMMENDED PCB(CONNECTOR SIDE VIEW)
THICKNESS=1.6 TO 2.4 MM

FUNCTIONAL SYMBOLS	THIS DRAWING CONTAINS INFORMATION THAT IS PROPRIETARY TO MOLEX ELECTRONIC TECHNOLOGIES, LLC AND SHOULD NOT BE USED WITHOUT WRITTEN PERMISSION		CURRENT REV DESC:		molex
	▽A = 0	mm	5:1		
DIVISIONAL SYMBOLS	GENERAL TOLERANCES (UNLESS SPECIFIED)		EC NO: 697101		HEADER OF NANO-FIT, D/R, CLIP, VERTICAL POWER CONNECTOR
	▽E = 0	ANGULAR TOL ± 3.0°		DRWN: GLLI 2022/02/24	
DIVISIONAL SYMBOLS	4 PLACES	±	0.1	CHK'D: XQZHANG 2022/02/25	PRODUCT CUSTOMER DRAWING
	2 PLACES	±	0.2	APPR: XQZHANG 2022/02/25	
	1 PLACE	±	0.3	INITIAL REVISION:	DOCUMENT NUMBER
	0 PLACES	±		DRWN: GLLI 2019/09/24	1053121000-SD
DRAFT WHERE APPLICABLE MUST REMAIN WITHIN DIMENSIONS		THIRD ANGLE PROJECTION	DRAWING	SERIES	MATERIAL NUMBER
			A3-SIZE	105312	CUSTOMER
					GENERAL MARKET
					SHEET NUMBER
					1 OF 5

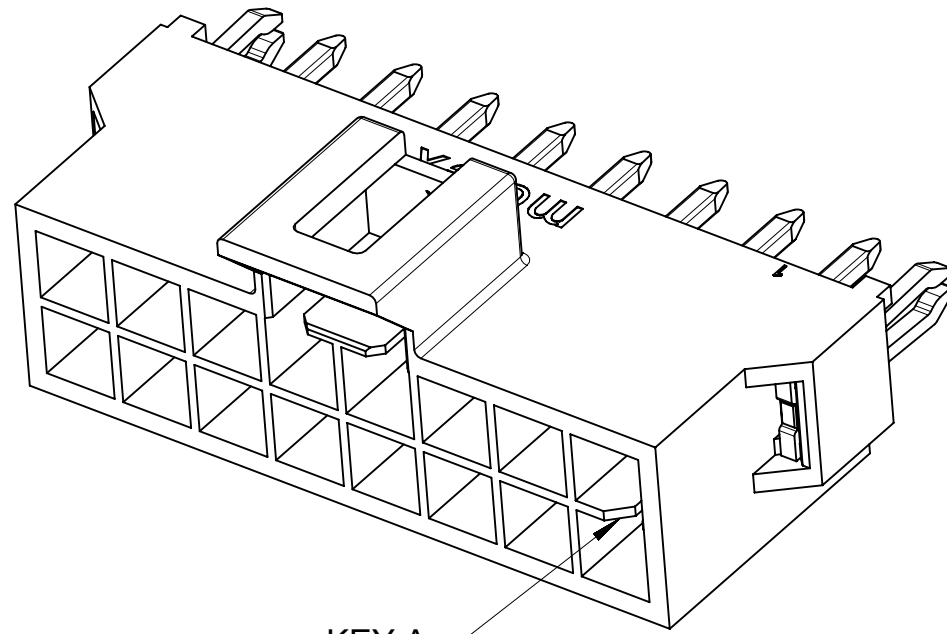

KEY A

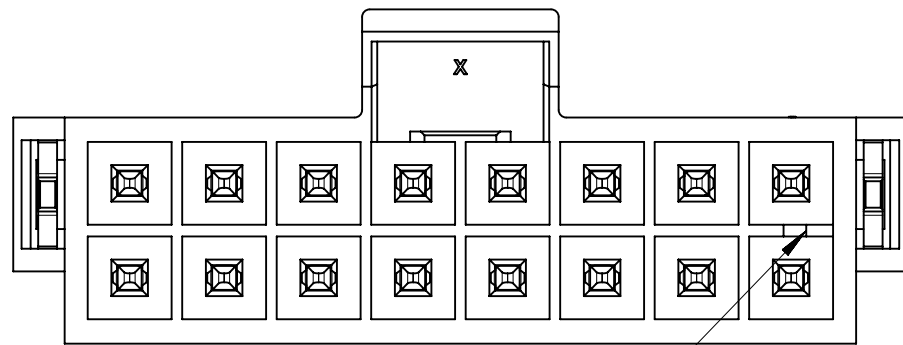

KEY A

BLACK

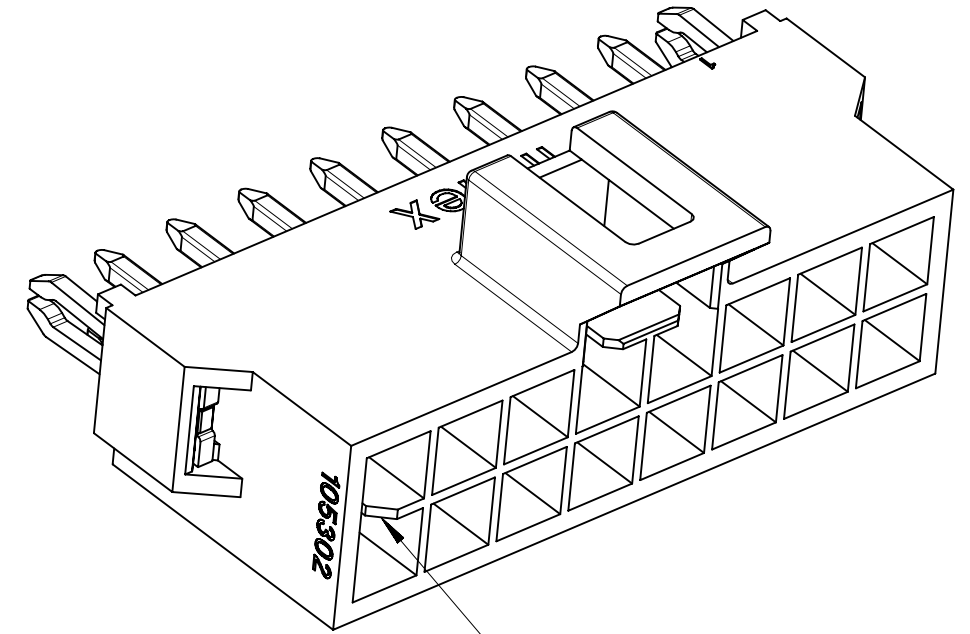

KEY B

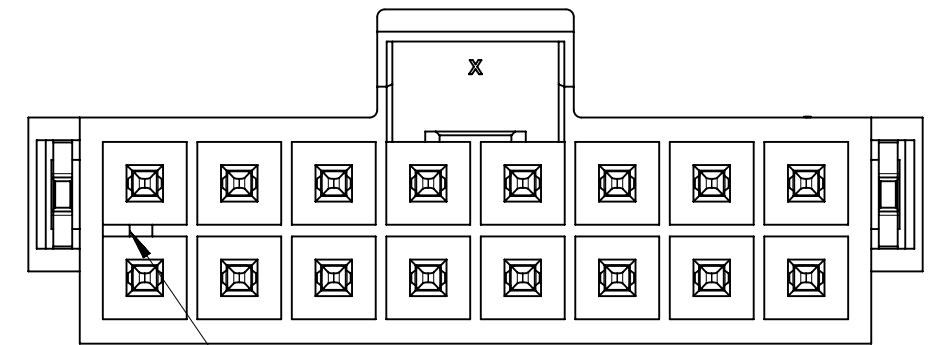

KEY B

NATURAL

COLOR OPTION

FUNCTIONAL SYMBOLS	THIS DRAWING CONTAINS INFORMATION THAT IS PROPRIETARY TO MOLEX ELECTRONIC TECHNOLOGIES, LLC AND SHOULD NOT BE USED WITHOUT WRITTEN PERMISSION		CURRENT REV DESC:		molex			
	▽A = 0	mm						SCALE 5:1
▽E = 0	GENERAL TOLERANCES (UNLESS SPECIFIED)		EC NO: 697101 DRWN: GLLI 2022/02/24 CHK'D: XQZHANG 2022/02/25 APPR: XQZHANG 2022/02/25 INITIAL REVISION: DRWN: GLLI 2019/09/24 APPR: YXZHENG 2020/03/16		HEADER OF NANO-FIT, D/R, CLIP, VERTICAL POWER CONNECTOR			
▽E = 0	ANGULAR TOL ± 3.0°				PRODUCT CUSTOMER DRAWING			
DIVISIONAL SYMBOLS	4 PLACES ±	0.1			DOCUMENT NUMBER	DOC TYPE	DOC PART	REVISION
	3 PLACES ±	0.2			1053121000-SD	PSD	000	B1
	2 PLACES ±	0.3			MATERIAL NUMBER	CUSTOMER		SHEET NUMBER
	1 PLACE ±		A3-SIZE	105312	GENERAL MARKET		2 OF 5	
	0 PLACES ±		THIRD ANGLE PROJECTION					
	DRAFT WHERE APPLICABLE MUST REMAIN WITHIN DIMENSIONS							

DOCUMENT STATUS	P1	RELEASE DATE	2022/02/25	03:08:44
-----------------	----	--------------	------------	----------

10	9	8	7	6	5	4	3	2	1
PART NUMBER	DIM 'A'	DIM 'B'	DIM 'C'	CKT SIZE	PLATING	MYLAR			
105312-3504	8.66	5.94	6.84	4	TIN				
105312-3506	11.16	8.44	9.34	6					
105312-3508	13.66	10.94	11.84	8					
105312-3510	16.16	13.44	14.34	10					
105312-3512	18.66	15.94	16.84	12					
105312-3514	21.16	18.44	19.34	14					
105312-3516	23.66	20.94	21.84	16					
105312-3704	8.66	5.94	6.84	4			GOLD 0.38		
105312-3706	11.16	8.44	9.34	6					
105312-3708	13.66	10.94	11.84	8					
105312-3710	16.16	13.44	14.34	10					
105312-3712	18.66	15.94	16.84	12					
105312-3714	21.16	18.44	19.34	14					
105312-3716	23.66	20.94	21.84	16					
105312-3604	8.66	5.94	6.84	4	GOLD 0.76	YES			
105312-3606	11.16	8.44	9.34	6					
105312-3608	13.66	10.94	11.84	8					
105312-3610	16.16	13.44	14.34	10					
105312-3612	18.66	15.94	16.84	12					
105312-3614	21.16	18.44	19.34	14					
105312-3616	23.66	20.94	21.84	16					
105312-3804	8.66	5.94	6.84	4			GOLD 0.76 + LUBE		
105312-3806	11.16	8.44	9.34	6					
105312-3808	13.66	10.94	11.84	8					
105312-3810	16.16	13.44	14.34	10					
105312-3812	18.66	15.94	16.84	12					
105312-3814	21.16	18.44	19.34	14					
105312-3816	23.66	20.94	21.84	16					
COLOR: BLACK									

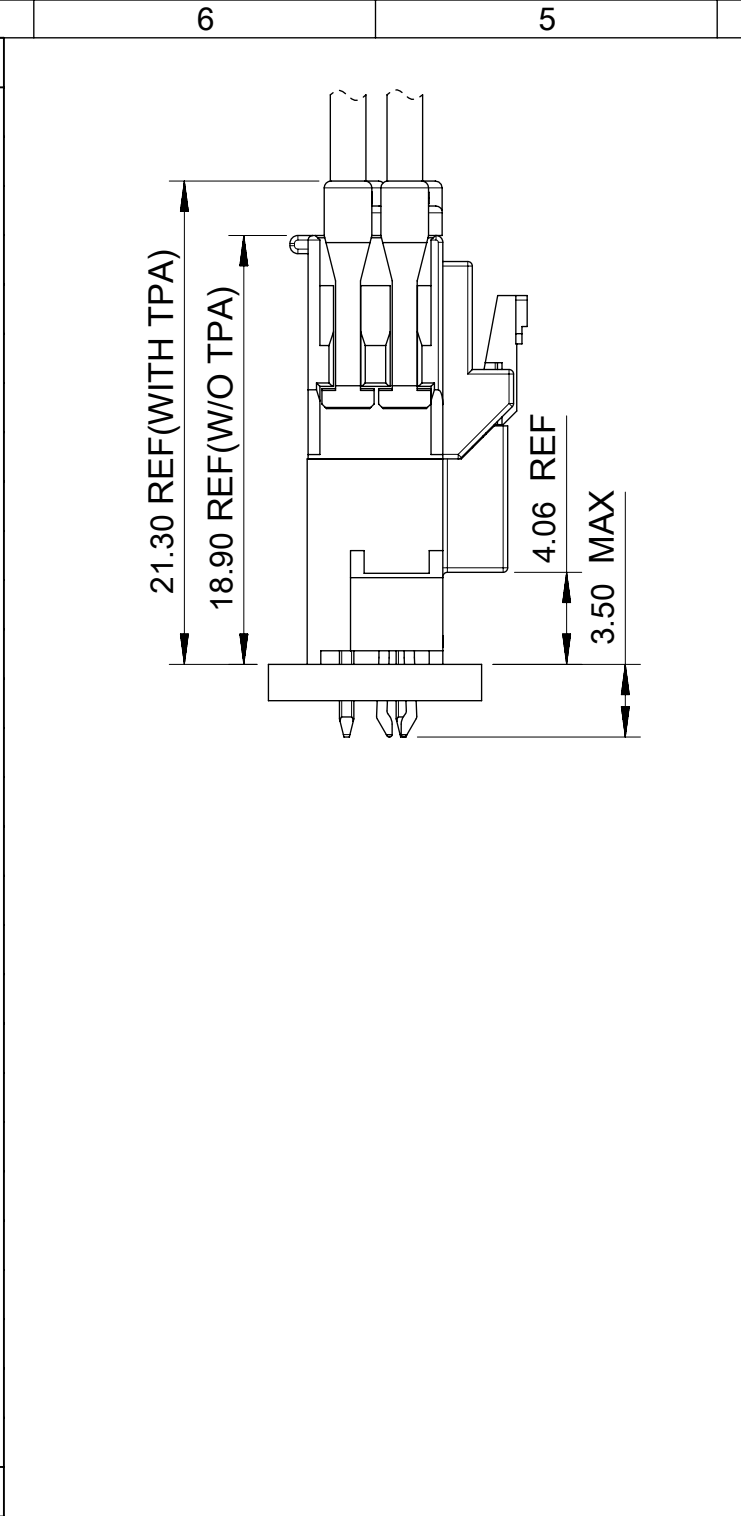

10	9	8	7	6	5	4	3	2	1
PART NUMBER	DIM 'A'	DIM 'B'	DIM 'C'	CKT SIZE	PLATING	MYLAR			
105312-4504	8.66	5.94	6.84	4	TIN				
105312-4506	11.16	8.44	9.34	6					
105312-4508	13.66	10.94	11.84	8					
105312-4510	16.16	13.44	14.34	10					
105312-4512	18.66	15.94	16.84	12					
105312-4514	21.16	18.44	19.34	14					
105312-4516	23.66	20.94	21.84	16					
105312-4704	8.66	5.94	6.84	4			GOLD 0.38		
105312-4706	11.16	8.44	9.34	6					
105312-4708	13.66	10.94	11.84	8					
105312-4710	16.16	13.44	14.34	10					
105312-4712	18.66	15.94	16.84	12					
105312-4714	21.16	18.44	19.34	14					
105312-4716	23.66	20.94	21.84	16					
105312-4604	8.66	5.94	6.84	4	GOLD 0.76	YES			
105312-4606	11.16	8.44	9.34	6					
105312-4608	13.66	10.94	11.84	8					
105312-4610	16.16	13.44	14.34	10					
105312-4612	18.66	15.94	16.84	12					
105312-4614	21.16	18.44	19.34	14					
105312-4616	23.66	20.94	21.84	16					
105312-4804	8.66	5.94	6.84	4			GOLD 0.76 + LUBE		
105312-4806	11.16	8.44	9.34	6					
105312-4808	13.66	10.94	11.84	8					
105312-4810	16.16	13.44	14.34	10					
105312-4812	18.66	15.94	16.84	12					
105312-4814	21.16	18.44	19.34	14					
105312-4816	23.66	20.94	21.84	16					
COLOR: NATURAL									

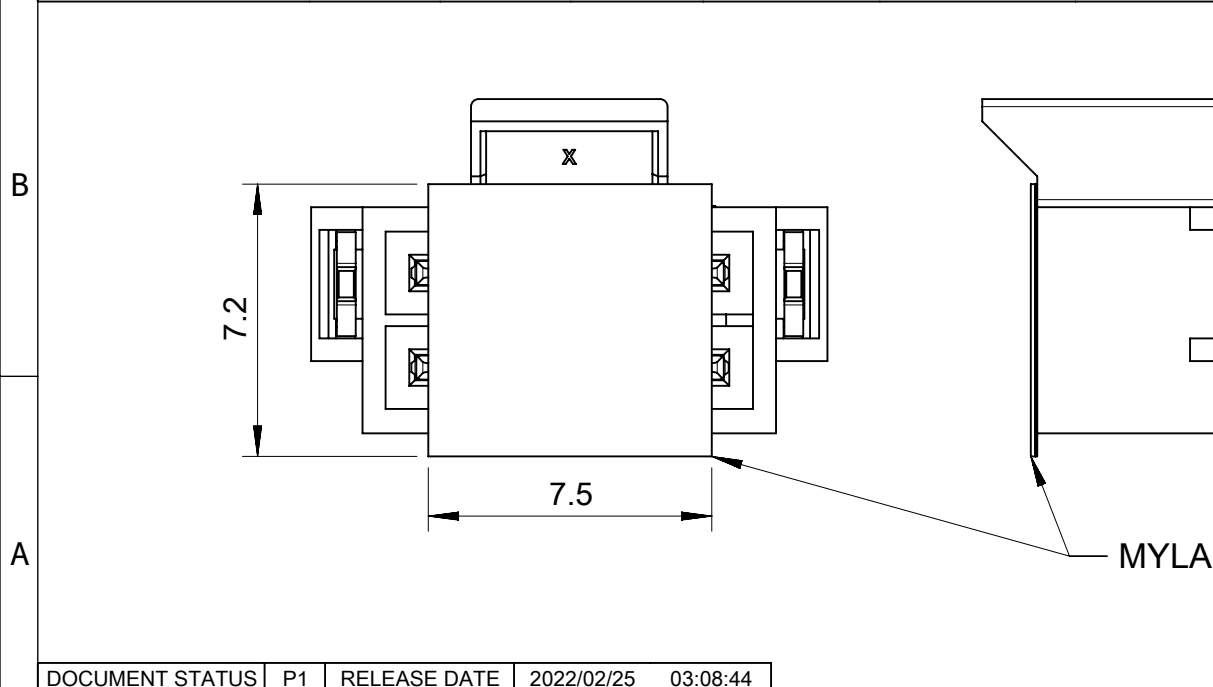

FUNCTIONAL SYMBOLS	THIS DRAWING CONTAINS INFORMATION THAT IS PROPRIETARY TO MOLEX ELECTRONIC TECHNOLOGIES, LLC AND SHOULD NOT BE USED WITHOUT WRITTEN PERMISSION	CURRENT REV DESC:		molex																										
	<table border="1"> <tr><td>FUNCTIONAL SYMBOLS</td><td>THIS DRAWING CONTAINS INFORMATION THAT IS PROPRIETARY TO MOLEX ELECTRONIC TECHNOLOGIES, LLC AND SHOULD NOT BE USED WITHOUT WRITTEN PERMISSION</td></tr> <tr><td>▽A = 0</td><td>mm 5:1</td></tr> <tr><td>▽E = 0</td><td>GENERAL TOLERANCES (UNLESS SPECIFIED)</td></tr> <tr><td>▽F = 0</td><td>ANGULAR TOL ± 3.0°</td></tr> <tr><td>DIVISIONAL SYMBOLS</td><td></td></tr> <tr><td>4 PLACES</td><td>±</td></tr> <tr><td>3 PLACES</td><td>± 0.1</td></tr> <tr><td>2 PLACES</td><td>± 0.2</td></tr> <tr><td>1 PLACE</td><td>± 0.3</td></tr> <tr><td>0 PLACES</td><td>±</td></tr> <tr><td>DRAFT WHERE APPLICABLE MUST REMAIN WITHIN DIMENSIONS</td><td></td></tr> </table>	FUNCTIONAL SYMBOLS	THIS DRAWING CONTAINS INFORMATION THAT IS PROPRIETARY TO MOLEX ELECTRONIC TECHNOLOGIES, LLC AND SHOULD NOT BE USED WITHOUT WRITTEN PERMISSION					▽A = 0	mm 5:1	▽E = 0	GENERAL TOLERANCES (UNLESS SPECIFIED)	▽F = 0	ANGULAR TOL ± 3.0°	DIVISIONAL SYMBOLS		4 PLACES	±	3 PLACES	± 0.1	2 PLACES	± 0.2	1 PLACE	± 0.3	0 PLACES	±	DRAFT WHERE APPLICABLE MUST REMAIN WITHIN DIMENSIONS		EC NO: 697101 DRWN: GLLI CHK'D: XQZHANG APPR: XQZHANG		2022/02/24 2022/02/25 2022/02/25
FUNCTIONAL SYMBOLS	THIS DRAWING CONTAINS INFORMATION THAT IS PROPRIETARY TO MOLEX ELECTRONIC TECHNOLOGIES, LLC AND SHOULD NOT BE USED WITHOUT WRITTEN PERMISSION																													
▽A = 0	mm 5:1																													
▽E = 0	GENERAL TOLERANCES (UNLESS SPECIFIED)																													
▽F = 0	ANGULAR TOL ± 3.0°																													
DIVISIONAL SYMBOLS																														
4 PLACES	±																													
3 PLACES	± 0.1																													
2 PLACES	± 0.2																													
1 PLACE	± 0.3																													
0 PLACES	±																													
DRAFT WHERE APPLICABLE MUST REMAIN WITHIN DIMENSIONS																														
INITIAL REVISION: DRWN: GLLI APPR: YXZHENG				2019/09/24 2020/03/16		PRODUCT CUSTOMER DRAWING																								
THIRD ANGLE PROJECTION				DRAWING		SERIES		DOCUMENT NUMBER		DOC TYPE DOC PART REVISION																				
A3-SIZE				105312		1053121000-SD		PSD		000 B1																				
MATERIAL NUMBER				CUSTOMER		SHEET NUMBER		GENERAL MARKET 3 OF 5																						

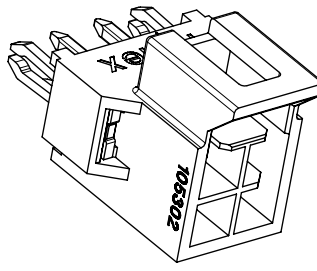
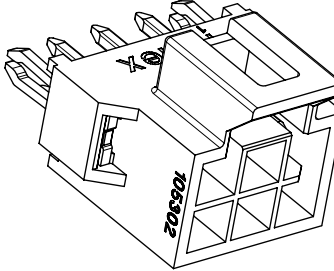
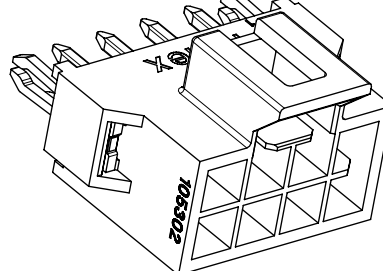
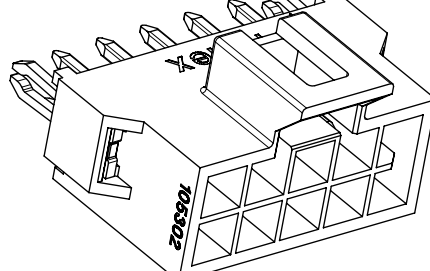
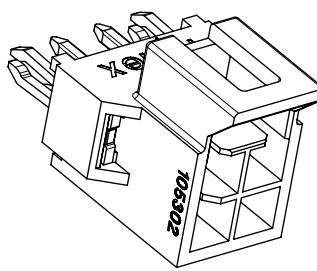
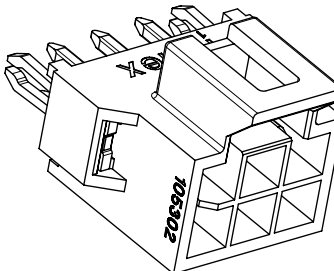
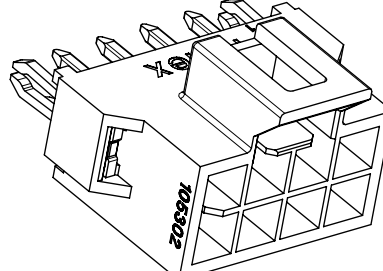
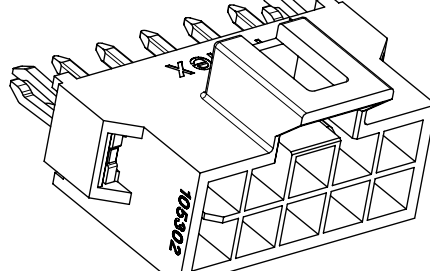
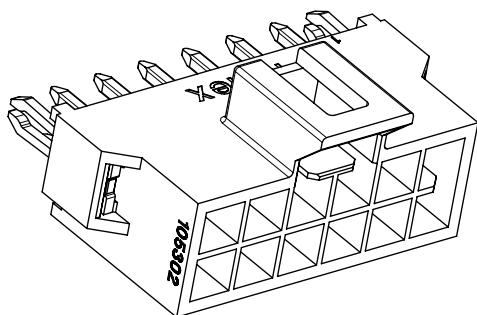
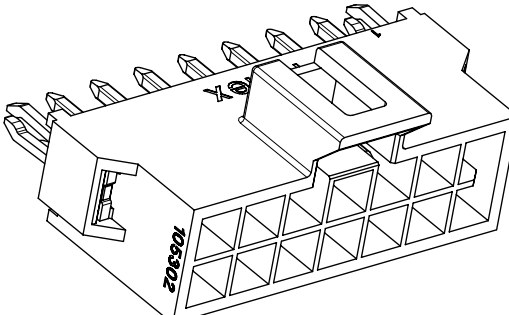
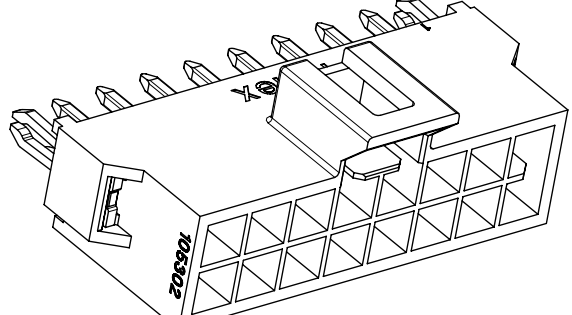
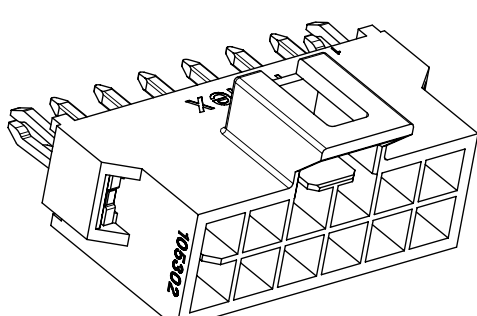
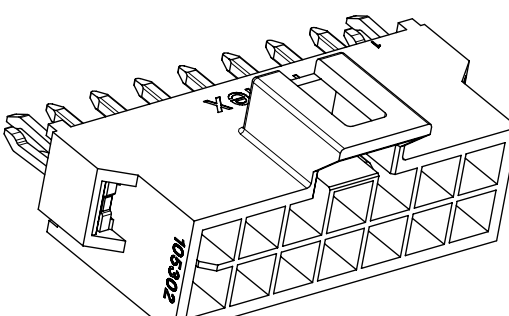
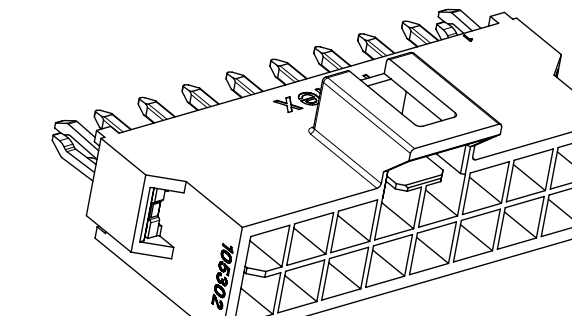
		4 CKT	6 CKT	8 CKT	10 CKT
F	BLACK				
E	NATURAL				
		12 CKT	14 CKT	16 CKT	
D	BLACK				
C	NATURAL				

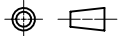
FUNCTIONAL SYMBOLS $\nabla_A = 0$ $\nabla_E = 0$ $\nabla_V = 0$	THIS DRAWING CONTAINS INFORMATION THAT IS PROPRIETARY TO MOLEX ELECTRONIC TECHNOLOGIES, LLC AND SHOULD NOT BE USED WITHOUT WRITTEN PERMISSION DIMENSION UNITS: mm SCALE: 3:1	CURRENT REV DESC: EC NO: 697101 DRWN: GLLI CHK'D: XQZHANG APPR: XQZHANG INITIAL REVISION: DRWN: GLLI APPR: YXZHENG	 HEADER OF NANO-FIT, D/R, CLIP, VERTICAL POWER CONNECTOR		
	GENERAL TOLERANCES (UNLESS SPECIFIED) ANGULAR TOL $\pm 3.0^\circ$ 4 PLACES \pm 3 PLACES ± 0.1 2 PLACES ± 0.2 1 PLACE ± 0.3 0 PLACES \pm				
DIVISIONAL SYMBOLS DRAFT WHERE APPLICABLE MUST REMAIN WITHIN DIMENSIONS	THIRD ANGLE PROJECTION 	DRAWING: A3-SIZE SERIES: 105312	MATERIAL NUMBER: 1053121000-SD CUSTOMER: GENERAL MARKET	DOC TYPE: PSD DOC PART: 000 REVISION: B1	SHEET NUMBER: 4 OF 5

NOTES FOR ALL PARTS

1> MATERIAL:
 HOUSING: LCP, UL 94V-0.
 TERMINAL: BRASS.
 SOLDER CLIP: BRASS.

2> PLATING FINISHED:
 TERMINAL:
 CONTACT AREA: a. REFLOW MATTE TIN 1.5MICRONS MIN;
 b. GOLD 0.38 MICRONS MIN;
 c. GOLD 0.76 MICRONS MIN.
 SOLDER AREA: MATTE TIN 1.5 MICRONS MIN, UNDER PLATING NICKEL 1.25
 MICRONS MIN.
 SOLDER CLIP: MATTE TIN 2.5 MICRONS MIN, UNDER PLATING NICKEL 1.25
 MICRONS MIN.

3> PRODUCT SPECIFICATION: PS-105300-100.
 4> PACKAGE: TAPE REEL, 1053121000-PK.
 5> PRODUCT MATE WITH SERIES OF 105308(RECEPTACLE), 105300(CRIMP TERMINAL).
 6> PARTS CONFORM TO CLASS 'B'REQUIREMENTS OF COSMETIC SPECIFICATION
 PS-45499-002.
 7> DISCOLORATION IN THE BANDOLIER PIN CARRIER AREA OF THE PIN IS INHERENT TO
 THE PLATING PROCESS AND IS DUE TO THE MASKING DEFECT OF THE CARRIER, THIS
 DISCOLORATION IS IN A NON-FUNCTION AREA OF THE PIN AND WILL NOT AFFECT
 THE PERFORMANCE OF THE HEADER ASSEMBLY.

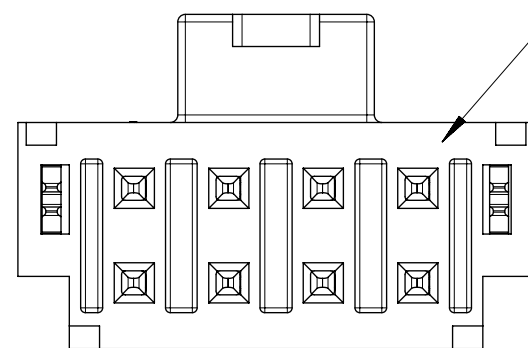

IF ANY NUMBER MARK APPEARS ON THIS SURFACE,
 PLEASE DISREGARD IT, IT IS NO ANY FUCTION AND
 NO ANY RELATION TO PIN NUMBER, IT IS JUST FOR
 MOLDING IDENDIFICATION.

FUNCTIONAL SYMBOLS	THIS DRAWING CONTAINS INFORMATION THAT IS PROPRIETARY TO MOLEX ELECTRONIC TECHNOLOGIES, LLC AND SHOULD NOT BE USED WITHOUT WRITTEN PERMISSION		CURRENT REV DESC:		molex			
	GENERAL TOLERANCES (UNLESS SPECIFIED)	EC NO: 697101						HEADER OF NANO-FIT, D/R, CLIP, VERTICAL POWER CONNECTOR
$\nabla_A = 0$	mm	1:1	DRWN: GLLI	2022/02/24	PRODUCT CUSTOMER DRAWING			
$\nabla_B = 0$	ANGULAR TOL $\pm 3.0^\circ$		CHK'D: XQZHANG	2022/02/25				
$\nabla_C = 0$	4 PLACES	\pm	APPR: XQZHANG	2022/02/25	DOCUMENT NUMBER			
DIVISIONAL SYMBOLS	3 PLACES	± 0.1	INITIAL REVISION:		1053121000-SD	PSD	000	B1
	2 PLACES	± 0.2	DRWN: GLLI	2019/09/24	DOC TYPE			
	1 PLACE	± 0.3	APPR: YXZHENG	2020/03/16	DOC PART			
	0 PLACES	\pm	DRAFT WHERE APPLICABLE MUST REMAIN WITHIN DIMENSIONS		REVISION			
	THIRD ANGLE PROJECTION		DRAWING	SERIES	MATERIAL NUMBER	CUSTOMER	SHEET NUMBER	
			A3-SIZE	105312		GENERAL MARKET	5 OF 5	