

8	7	6	5	4	3	2	1
PART NUMBER	THICKNESS	MATERIAL	PLATING TYPE	PACKAGING			
67B3G3006010010R0C	0.10mm	BeCu C17200	Au 1u" Over Ni 50~120u"	TAPE AND REEL			

REEL DIAMETER	TAPE WIDTH (W)	PITCH (P)	QUANTITY / REEL
330.2mm (13 inch)	24mm	12mm	500 pcs

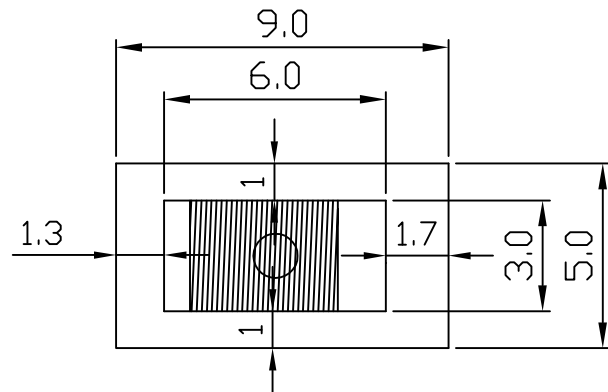
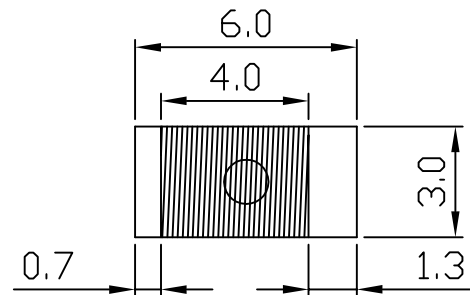
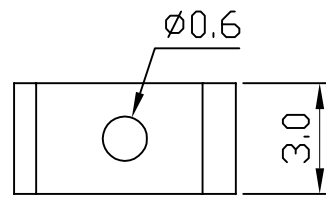
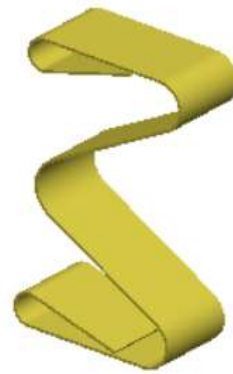
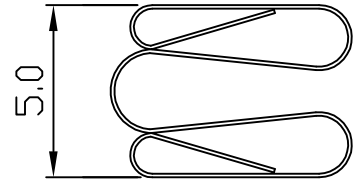
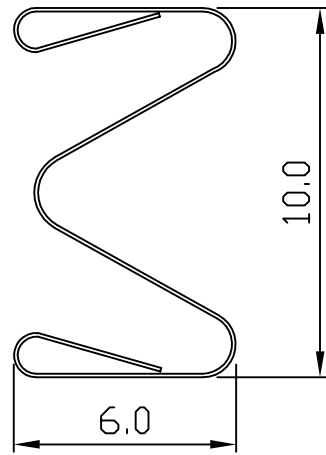

SOLDER PAD Dimension

Recommendation

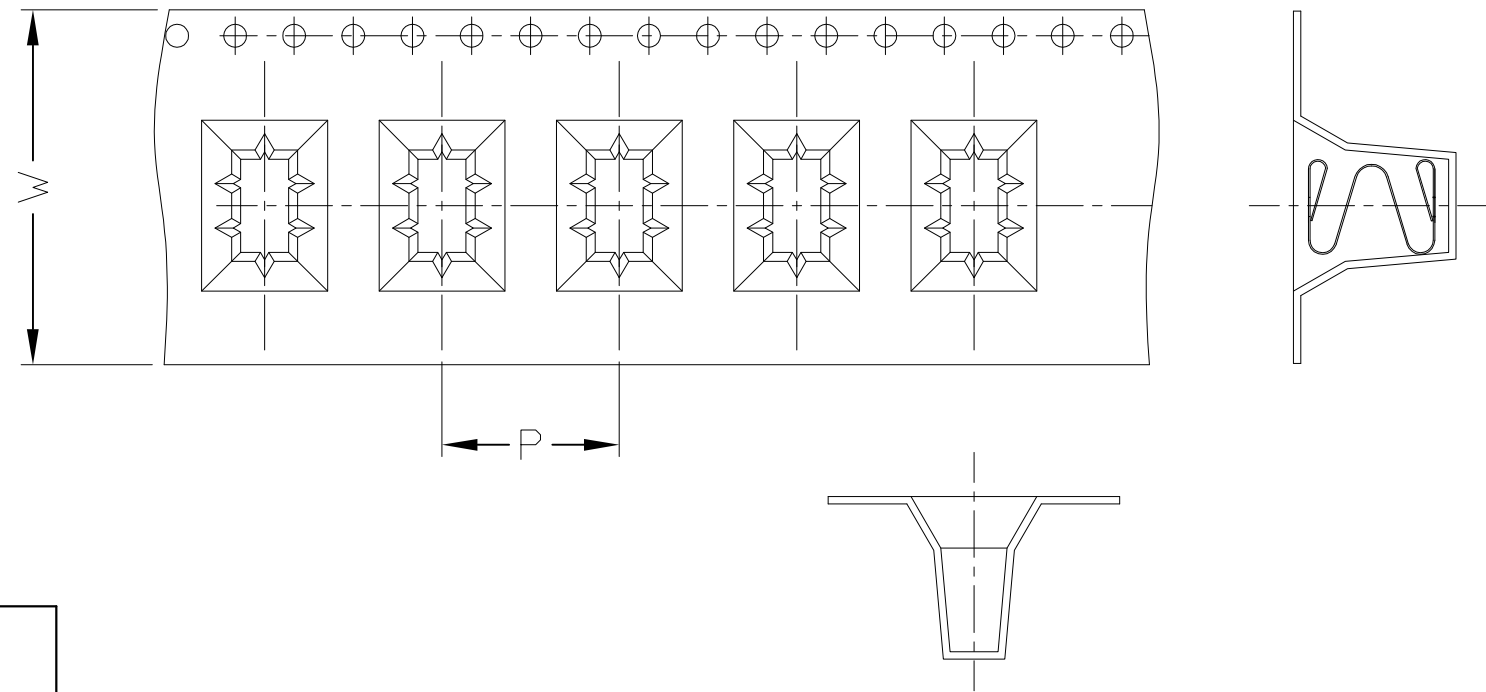

PART NUMBER CONFIGURATION:  
**67 B X X XXX XX XXX XX R XX**

67 FOR GENERAL ELECTRONICS  
68 FOR AUTOMOTIVE ELECTRONICS

MATERIAL: BECU

SHAPE TYPE

PLATING TYPE

PART WIDTH

VERSION CODE

PACKAGING: TAPE&REEL

PART THICKNESS

PART HEIGHT

PART LENGTH

UNITS: MM [INCH]	<b>Laird</b>	LAIRD DRAWING NUMBER: <b>B3G-30X60X100-SALES</b>
TOLERANCES: X.X = ±0.4 X.XX = ±0.2 X.XXX = ±0.1		THIS IS AN UNCONTROLLED SALES DRAWING. THE DIMENSIONAL CHARACTERISTICS AND TOLERANCES OF THIS PART SHOWN ON THIS DRAWING AS A REFERENCE TO THE DIMENSIONAL SPECIFICATIONS OF THE LAIRD STANDARD PRODUCTION DRAWING FOR THIS PART. ANY SUBSEQUENT CHANGES TO THE STANDARD PART SPECIFICATION WILL SUPERSEDE THIS SALES DRAWING.
ANGULAR: X° = ±3° X.X° = ±1.0°	3RD ANGLE PROJECTION	DESIGNED IN SOLIDWORKS
	SCALE: 5:1	SHEET 1 OF 1
		SIZE B