

100301

Low Power Triple 5-Input OR/NOR Gate

General Description

The 100301 is a monolithic triple 5-input OR/NOR gate. All inputs have 50 kΩ pull-down resistors and all outputs are buffered.

- 2000V ESD protection
- Pin/function compatible with 100101
- Voltage compensated operating range = -4.2V to -5.7V
- Available to MIL-STD-883
- Available to industrial grade temperature range

Features

- 23% power reduction of the 100101

Ordering Code:

Logic Symbol

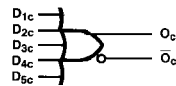
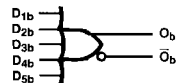
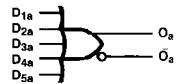

DS010579-1

Pin Names	Description
D_{na}, D_{nb}, D_{nc}	Data Inputs
O_a, O_b, O_c	Data Outputs
$\bar{O}_a, \bar{O}_b, \bar{O}_c$	Complementary Data Outputs

Connection Diagrams

24-Pin DIP/SOIC

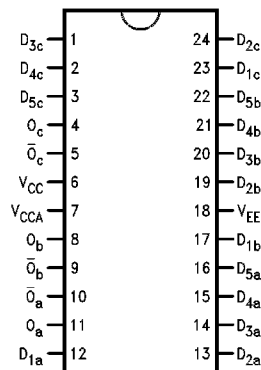

DS010579-2

Connection Diagrams (Continued)

28-Pin PCC

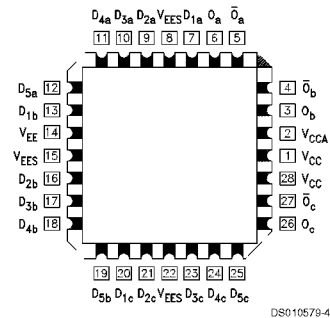

24-Pin Quad Cerpak

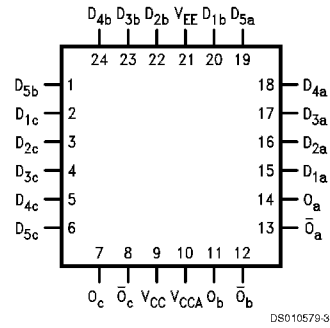

Absolute Maximum Ratings (Note 1)

Above which the useful life may be impaired

Storage Temperature (T_{STG})	-65°C to +150°C
Maximum Junction Temperature (T_J)	
Ceramic	+175°C
Plastic	+150°C
V_{EE} Pin Potential to Ground Pin	-7.0V to +0.5V
Input Voltage (DC)	V_{EE} to +0.5V
Output Current (DC Output HIGH)	-50 mA
ESD (Note 2)	≥2000V

Recommended Operating Conditions

Case Temperature (T_C)	
Commercial	0°C to +85°C
Industrial	-40°C to +85°C
Military	-55°C to +125°C
Supply Voltage (V_{EE})	-5.7V to -4.2V

Note 1: Absolute maximum ratings are those values beyond which the device may be damaged or have its useful life impaired. Functional operation under these conditions is not implied.

Note 2: ESD testing conforms to MIL-STD-883, Method 3015.

Commercial Version DC Electrical Characteristics

$V_{EE} = -4.2V$ to $-5.7V$, $V_{CC} = V_{CCA} = GND$, $T_C = 0^\circ C$ to $+85^\circ C$ (Note 3)

Symbol	Parameter	Min	Typ	Max	Units	Conditions	
V_{OH}	Output HIGH Voltage	-1025	-955	-870	mV	$V_{IN} = V_{IH(Max)}$ or $V_{IL(Min)}$	Loading with 50Ω to -2.0V
V_{OL}	Output LOW Voltage	-1830	-1705	-1620	mV		
V_{OHC}	Output HIGH Voltage	-1035			mV	$V_{IN} = V_{IH(Min)}$ or $V_{IL(Max)}$	Loading with 50Ω to -2.0V
V_{OLC}	Output LOW Voltage			-1610	mV		
V_{IH}	Input HIGH Voltage	-1165		-870	mV	Guaranteed HIGH Signal for All Inputs	
V_{IL}	Input LOW Voltage	-1830		-1475	mV	Guaranteed LOW Signal for All Inputs	
I_{IL}	Input LOW Current	0.50			μA	$V_{IN} = V_{IL(Min)}$	
I_{IH}	Input HIGH Current			240	μA	$V_{IN} = V_{IH(Max)}$	
I_{EE}	Power Supply Current	-29	-17	-15	mA	Inputs Open	

Note 3: The specified limits represent the "worst case" value for the parameter. Since these values normally occur at the temperature extremes, additional noise immunity and guardbanding can be achieved by decreasing the allowable system operating ranges. Conditions for testing shown in the tables are chosen to guarantee operation under "worst case" conditions.

DIP AC Electrical Characteristics

$V_{EE} = -4.2V$ to $-5.7V$, $V_{CC} = V_{CCA} = GND$

Symbol	Parameter	$T_C = 0^\circ C$		$T_C = +25^\circ C$		$T_C = +85^\circ C$		Units	Conditions
		Min	Max	Min	Max	Min	Max		
t_{PLH}	Propagation Delay	0.50	1.10	0.50	1.15	0.50	1.20	ns	Figures 1, 2 (Note 4)
t_{PHL}	Data to Output								
t_{TLH}	Transition Time	0.40	1.20	0.40	1.20	0.40	1.20	ns	Figures 1, 2
t_{THL}	20% to 80%, 80% to 20%								

Note 4: The propagation delay specified is for single output switching. Delays may vary up to 100 ps with multiple outputs switching.

SOIC, PCC and Cerpak AC Electrical Characteristics

$V_{EE} = -4.2V$ to $-5.7V$, $V_{CC} = V_{CCA} = GND$

Symbol	Parameter	$T_C = 0^\circ C$		$T_C = +25^\circ C$		$T_C = +85^\circ C$		Units	Conditions
		Min	Max	Min	Max	Min	Max		
t_{PLH}	Propagation Delay	0.50	1.00	0.50	1.05	0.50	1.10	ns	Figures 1, 2 (Note 6)
t_{PHL}	Data to Output								
t_{TLH}	Transition Time	0.40	1.10	0.40	1.10	0.40	1.10	ns	Figures 1, 2
t_{THL}	20% to 80%, 80% to 20%								
t_{OSHL}	Maximum Skew Common Edge Output-to-Output Variation Data to Output Path		240		240		240	ps	PCC Only (Note 5)

SOIC, PCC and Cerpak AC Electrical Characteristics (Continued)

$V_{EE} = -4.2V$ to $-5.7V$, $V_{CC} = V_{CCA} = GND$

Symbol	Parameter	$T_C = 0^\circ C$		$T_C = +25^\circ C$		$T_C = +85^\circ C$		Units	Conditions
		Min	Max	Min	Max	Min	Max		
t_{OSLH}	Maximum Skew Common Edge Output-to-Output Variation Data to Output Path	330		330		330		ps	PCC Only (Note 5)
t_{OST}	Maximum Skew Opposite Edge Output-to-Output Variation Data to Output Path	330		330		330		ps	PCC Only (Note 5)
t_{PS}	Maximum Skew Pin (Signal) Transition Variation Data to Output Path	230		230		230		ps	PCC Only (Note 5)

Note 5: Output-to-Output Skew is defined as the absolute value of the difference between the actual propagation delay for any outputs within the same packaged device. The specifications apply to any outputs switching in the same direction either HIGH to LOW (t_{OSHL}), or LOW to HIGH (t_{OSLH}), or in opposite directions both HL and LH (t_{OST}). Parameters t_{OST} and t_{PS} guaranteed by design.

Note 6: The propagation delay specified is for single output switching. Delays may vary up to 100 ps with multiple outputs switching.

Industrial Version PCC DC Electrical Characteristics

$V_{EE} = -4.2V$ to $-5.7V$, $V_{CC} = V_{CCA} = GND$, $T_C = -40^\circ C$ to $+85^\circ C$ (Note 7)

Symbol	Parameter	$T_C = -40^\circ C$		$T_C = 0^\circ C$ to $+85^\circ C$		Units	Conditions	
		Min	Max	Min	Max			
V_{OH}	Output HIGH Voltage	-1085	-870	-1025	-870	mV	$V_{IN} = V_{IH(Max)}$ or $V_{IL(Min)}$	Loading with 50Ω to $-2.0V$
V_{OL}	Output LOW Voltage	-1830	-1575	-1830	-1620	mV		
V_{OHC}	Output HIGH Voltage	-1095		-1035		mV	$V_{IN} = V_{IH(Min)}$ or $V_{IL(Max)}$	Loading with 50Ω to $-2.0V$
V_{OLC}	Output LOW Voltage		-1565		-1610	mV		
V_{IH}	Input HIGH Voltage	-1170	-870	-1165	-870	mV	Guaranteed HIGH Signal for All Inputs	
V_{IL}	Input LOW Voltage	-1830	-1480	-1830	-1475	mV	Guaranteed LOW Signal for All Inputs	
I_{IL}	Input LOW Current	0.50		0.50		μA	$V_{IN} = V_{IL(Min)}$	
I_{IH}	Input HIGH Current		240		240	μA	$V_{IN} = V_{IH(Max)}$	
I_{EE}	Power Supply Current	-29	-15	-29	-15	mA	Inputs Open	

Note 7: The specified limits represent the "worst case" value for the parameter. Since these values normally occur at the temperature extremes, additional noise immunity and guardbanding can be achieved by decreasing the allowable system operating ranges. Conditions for testing shown in the tables are chosen to guarantee operation under "worst case" conditions.

PCC AC Electrical Characteristics

$V_{EE} = -4.2V$ to $-5.7V$, $V_{CC} = V_{CCA} = GND$

Symbol	Parameter	$T_C = -40^\circ C$		$T_C = +25^\circ C$		$T_C = +85^\circ C$		Units	Conditions
		Min	Max	Min	Max	Min	Max		
t_{PLH}	Propagation Delay Data to Output	0.40	1.00	0.50	1.05	0.50	1.10	ns	Figures 1, 2 (Note 8)
t_{TLH}	Transition Time 20% to 80%, 80% to 20%	0.30	1.10	0.40	1.10	0.40	1.10	ns	Figures 1, 2

Note 8: The propagation delay specified is for single output switching. Delays may vary up to 100 ps with multiple outputs switching.

Military Version DC Electrical Characteristics

$V_{EE} = -4.2V$ to $-5.7V$, $V_{CC} = V_{CCA} = GND$, $T_C = -55^\circ C$ to $+125^\circ C$

Symbol	Parameter	Min	Max	Units	T_C	Conditions	Notes	
V_{OH}	Output HIGH Voltage	-1025	-870	mV	$0^\circ C$ to $+125^\circ C$	$V_{IN} = V_{IH(Max)}$ or $V_{IL} (Min)$	Loading with 50Ω to $-2.0V$	(Notes 9, 10, 11)
		-1085	-870	mV	$-55^\circ C$			
V_{OL}	Output LOW Voltage	-1830	-1620	mV	$0^\circ C$ to $+125^\circ C$	$V_{IN} = V_{IH(Min)}$ or $V_{IL} (Max)$	Loading with 50Ω to $-2.0V$	(Notes 9, 10, 11)
		-1830	-1555	mV	$-55^\circ C$			
V_{OHC}	Output HIGH Voltage	-1035		mV	$0^\circ C$ to $+125^\circ C$	$V_{IN} = V_{IH(Min)}$ or $V_{IL} (Max)$	Loading with 50Ω to $-2.0V$	(Notes 9, 10, 11)
		-1085		mV	$-55^\circ C$			
V_{OLC}	Output LOW Voltage		-1610	mV	$0^\circ C$ to $+125^\circ C$	$V_{IN} = V_{IH(Min)}$ or $V_{IL} (Max)$	Loading with 50Ω to $-2.0V$	(Notes 9, 10, 11)
			-1555	mV	$-55^\circ C$			
V_{IH}	Input HIGH Voltage	-1165	-870	mV	$-55^\circ C$ to $+125^\circ C$	Guaranteed HIGH Signal for All Inputs	(Notes 9, 10, 11, 12)	
V_{IL}	Input LOW Voltage	-1830	-1475	mV	$-55^\circ C$ to $+125^\circ C$	Guaranteed LOW Signal for All Inputs	(Notes 9, 10, 11, 12)	
I_{IL}	Input LOW Current	0.50		μA	$-55^\circ C$ to $+125^\circ C$	$V_{EE} = -4.2V$ $V_{IN} = V_{IL(Min)}$	(Notes 9, 10, 11)	
I_{IH}	Input HIGH Current		240	μA	$0^\circ C$ to $+125^\circ C$	$V_{EE} = -5.7V$ $V_{IN} = V_{IH} (Max)$	(Notes 9, 10, 11)	
			340	μA	$-55^\circ C$			
I_{EE}	Power Supply Current	-32	-12	mA	$-55^\circ C$ to $+125^\circ C$	Inputs Open	(Notes 9, 10, 11)	

Note 9: F100K 300 Series cold temperature testing is performed by temperature soaking (to guarantee junction temperature equals $-55^\circ C$), then testing immediately without allowing for the junction temperature to stabilize due to heat dissipation after power-up. This provides "cold start" specs which can be considered a worst case condition at cold temperatures.

Note 10: Screen tested 100% on each device at $-55^\circ C$, $+25^\circ C$, and $+125^\circ C$, Subgroups 1, 2, 3, 7, and 8.

Note 11: Sample tested (Method 5005, Table I) on each manufactured lot at $-55^\circ C$, $+25^\circ C$, and $+125^\circ C$, Subgroups A1, 2, 3, 7, and 8.

Note 12: Guaranteed by applying specified input condition and testing V_{OH}/V_{OL} .

AC Electrical Characteristics

$V_{EE} = -4.2V$ to $-5.7V$, $V_{CC} = V_{CCA} = GND$

Symbol	Parameter	$T_C = -55^\circ C$		$T_C = +25^\circ C$		$T_C = +125^\circ C$		Units	Conditions	Notes
		Min	Max	Min	Max	Min	Max			
t_{PLH}	Propagation Delay	0.25	1.70	0.30	1.50	0.30	1.80	ns	<i>Figures 1, 2</i>	(Notes 13, 14, 15, 17)
t_{PHL}	Data to Output									
t_{TLH}	Transition Time	0.30	1.20	0.30	1.20	0.30	1.20	ns		(Note 16)
t_{THL}	20% to 80%, 80% to 20%									

Note 13: F100K 300 Series cold temperature testing is performed by temperature soaking (to guarantee junction temperature equals $-55^\circ C$), then testing immediately after power-up. This provides "cold start" specs which can be considered a worst case condition at cold temperatures.

Note 14: Screen tested 100% on each device at $+25^\circ C$ temperature only, Subgroup A9.

Note 15: Sample tested (Method 5005, Table I) on each manufactured lot at $+25^\circ C$, Subgroup A9, and at $+125^\circ C$ and $-55^\circ C$ temperatures, Subgroups A10 and A11.

Note 16: Not tested at $+25^\circ C$, $+125^\circ C$, and $-55^\circ C$ temperature (design characterization data).

Note 17: The propagation delay specified is for single output switching. Delays may vary up to 100 ps with multiple outputs switching.

Test Circuitry

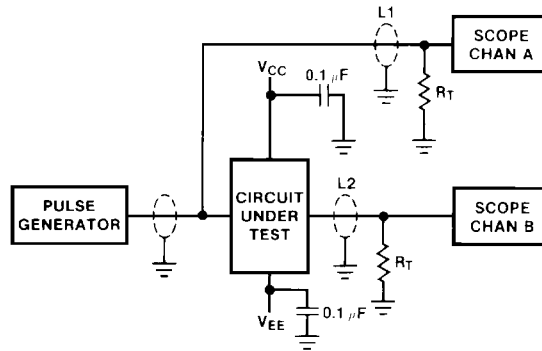

DS010579-5

Notes:

$V_{CC}, V_{CCA} = +2V, V_{EE} = -2.5V$
 $L1$ and $L2$ = equal length 50Ω impedance lines
 $R_T = 50\Omega$ terminator internal to scope
 Decoupling $0.1 \mu F$ from GND to V_{CC} and V_{EE}
 All unused outputs are loaded with 50Ω to GND
 C_L = Fixture and stray capacitance $\leq 3 pF$

FIGURE 1. AC Test Circuit

Switching Waveforms

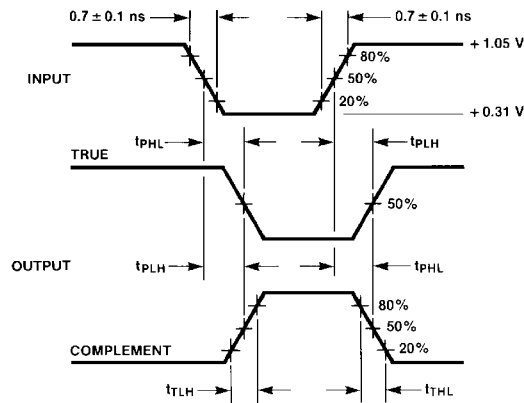

DS010579-6

FIGURE 2. Propagation Delay and Transition Times

Ordering Information

The device number is used to form part of a simplified purchasing code where a package type and temperature range are defined as follows:

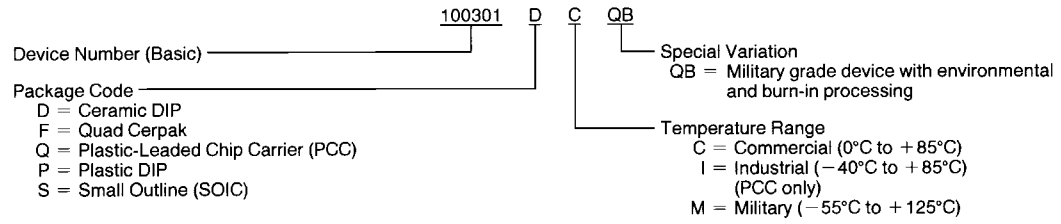

DS010579-7

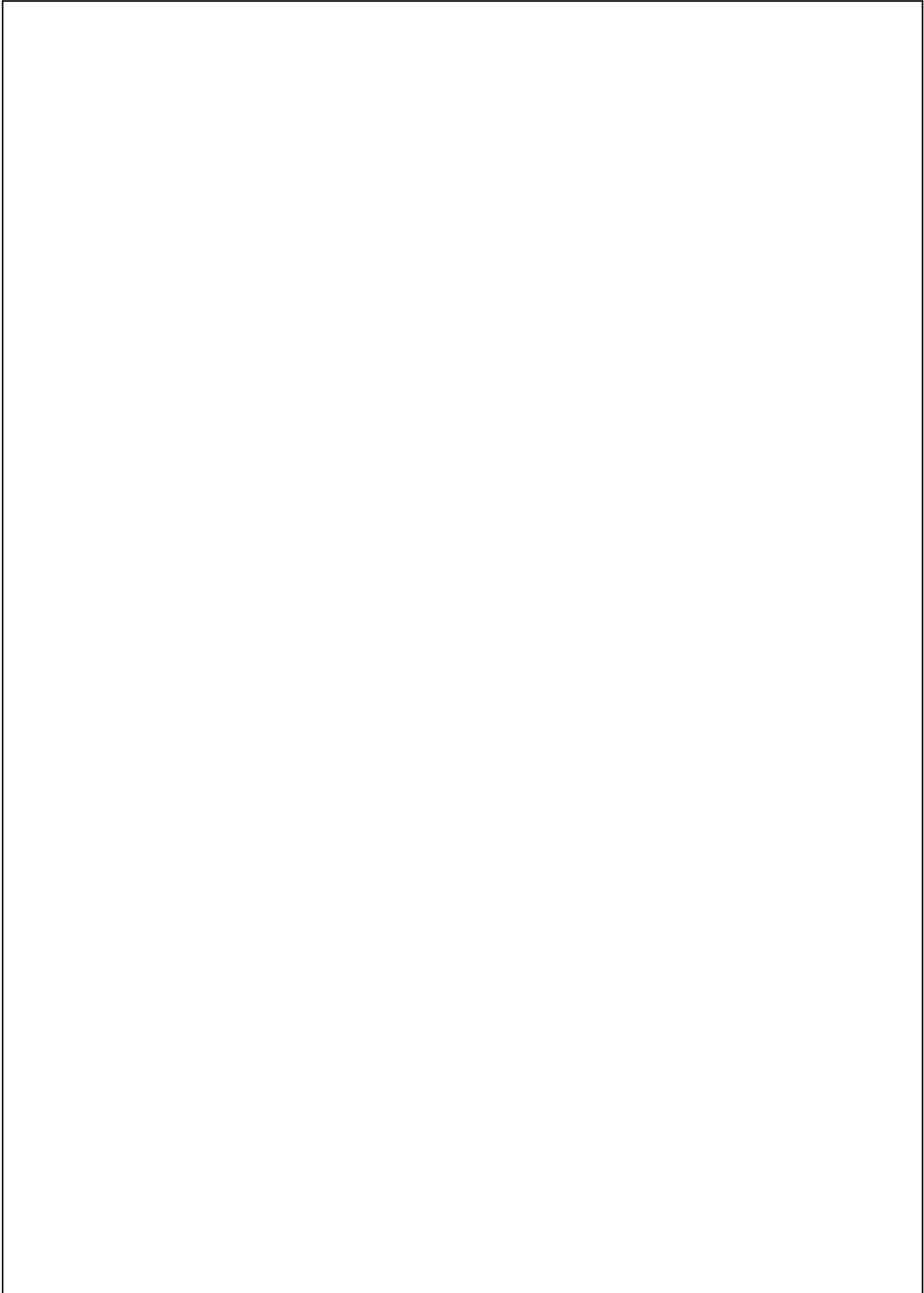

Physical Dimensions inches (millimeters) unless otherwise noted

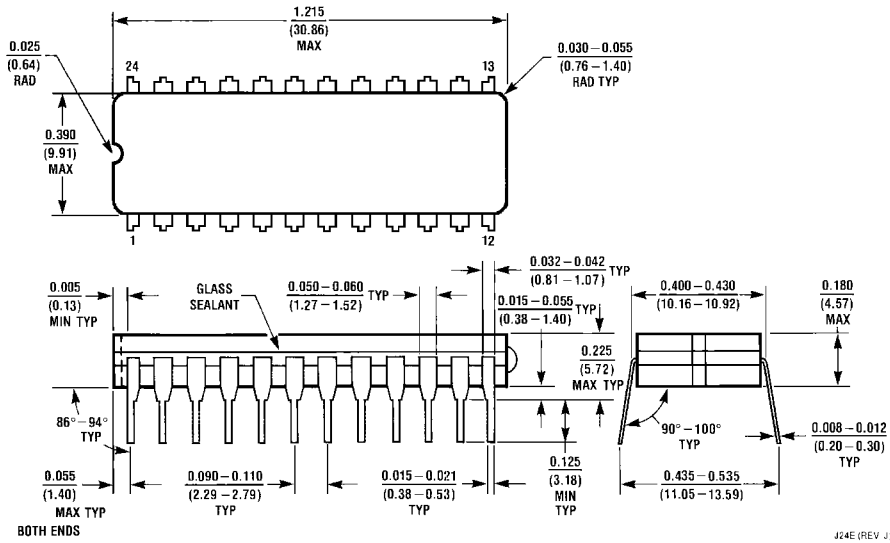

24-Lead Ceramic Dual-In-Line Package (0.400" Wide) (D)
Package Number J24E

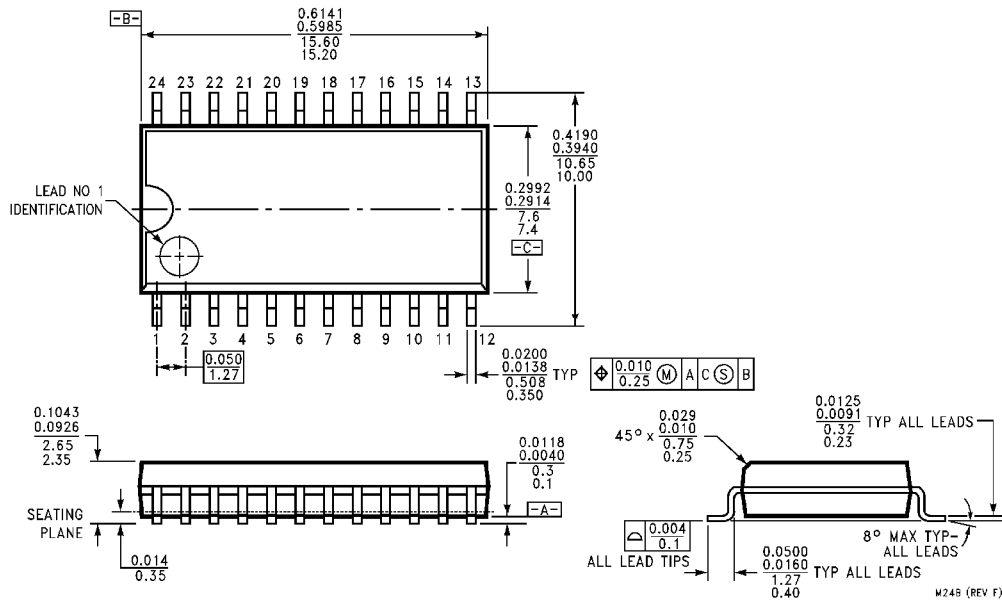

24-Lead Molded Package (0.300" Wide) (S)
Package Number M24B

Physical Dimensions inches (millimeters) unless otherwise noted (Continued)

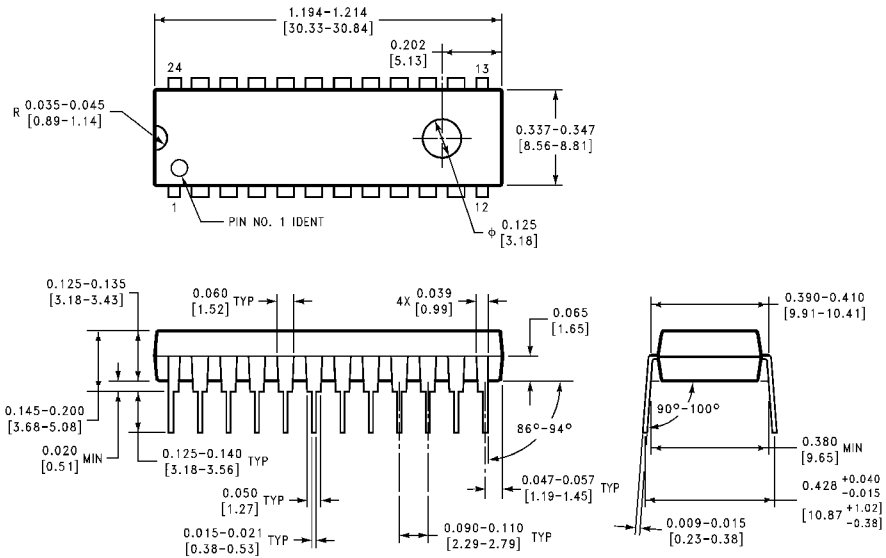

24-Lead Plastic Dual-In-Line Package (P)
Package Number N24E

N24E (REV A)

Physical Dimensions inches (millimeters) unless otherwise noted (Continued)

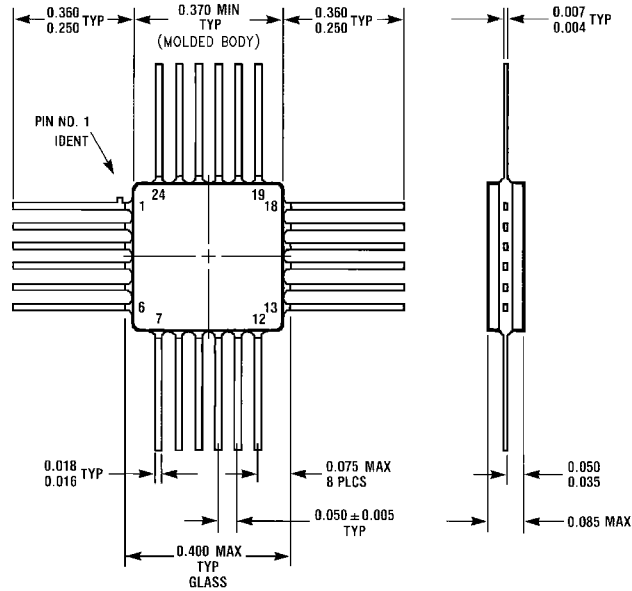

W24B (REV D)

**24-Lead Quad Cerpak (F)
Package Number W24B**

LIFE SUPPORT POLICY

FAIRCHILD'S PRODUCTS ARE NOT AUTHORIZED FOR USE AS CRITICAL COMPONENTS IN LIFE SUPPORT DEVICES OR SYSTEMS WITHOUT THE EXPRESS WRITTEN APPROVAL OF THE PRESIDENT OF FAIRCHILD SEMICONDUCTOR CORPORATION. As used herein:

1. Life support devices or systems are devices or systems which, (a) are intended for surgical implant into the body, or (b) support or sustain life, and (c) whose failure to perform when properly used in accordance with instructions for use provided in the labeling, can be reasonably expected to result in a significant injury to the user.
2. A critical component in any component of a life support device or system whose failure to perform can be reasonably expected to cause the failure of the life support device or system, or to affect its safety or effectiveness.

Fairchild Semiconductor Corporation Americas
Customer Response Center
Tel: 1-888-522-5372

Fairchild Semiconductor Europe
Fax: +49 (0) 1 80-530 85 86
Email: europe.support@nsc.com
Deutsch Tel: +49 (0) 8 141-35-0
English Tel: +44 (0) 1 793-85-68-56
Italy Tel: +39 (0) 2 57 5631

Fairchild Semiconductor Hong Kong Ltd.
13th Floor, Straight Block,
Ocean Centre, 5 Canton Rd.
Tsimshatsui, Kowloon
Hong Kong
Tel: +852 2737-7200
Fax: +852 2314-0061

National Semiconductor Japan Ltd.
Tel: 81-3-5620-6175
Fax: 81-3-5620-6179

www.fairchildsemi.com