



Part Number: D4I2652

Electrical Specifications

Frequency Range (GHz):	2.6 – 5.2
Isolation (dB):	36 MIN
Insertion Loss (dB):	1.2 MAX
VSWR:	1.3:1 MIN
Forward Power (W):	20 AVG 50 PK
Reflective Power (W):	2 AVG

Mechanical/Environmental Specifications

Connector Type:	SMA
Connector Body:	Passivated stainless steel
Connector Pin:	Gold plated copper
Load Body:	Brass
Magnetic Shunt:	Nickel plated CRS
Operational Temp:	0°C to +50°C
Weight (oz)	7.0 MAX

D4I2652 Dimensions

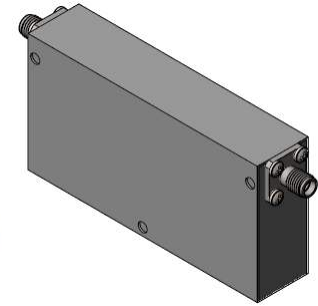
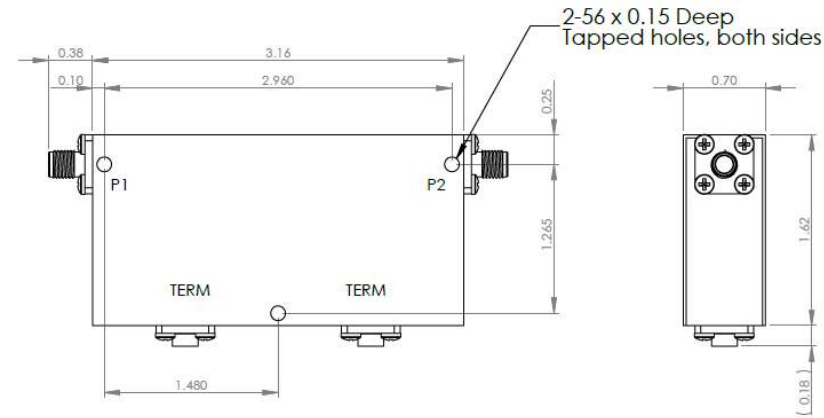

D4I2652-3 Dimensions

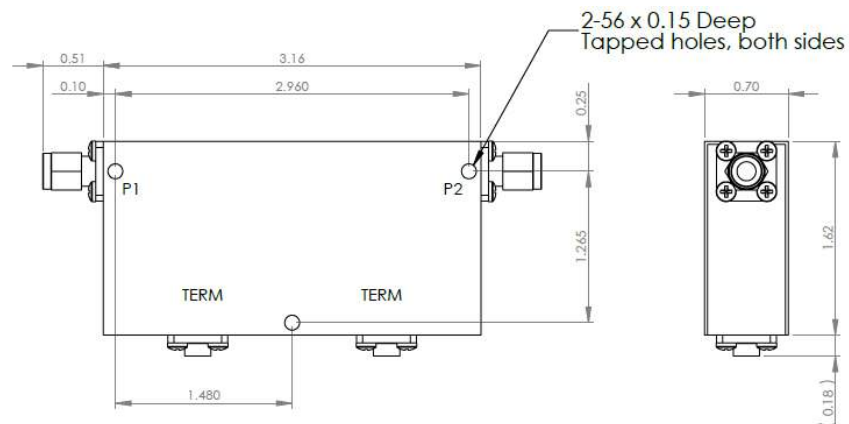

Dimensions are in inches
Tolerance

XX ±0.03
XXX ±0.010

Type of Device	PN Suffix	Connector Configuration Input / Output	PN Example
Single and Dual Junction Isolator, 2-Port Device Input / Output	N/A	Female / Female	D4I2652
	-1	Male / Female	D4I2652-1
	-2	Female / Male	D4I2652-2
	-3	Male / Male	D4I2652-3



MEASURED DATA

Part Number: D4I2652, +25°C

