

1600 W high efficiency PSU

Optimized form, fit and function
platform for server application

EVAL_1K6W_PSU_G7_DD

Meneses Herrera David (IFAT PMM ACDC AE)
Kutschak Matteo-Alessandro (IFAT PMM ACDC AE)
Zechner Florian (IFAT PMM ACDC AE)



Table of content

1

Introduction

2

Measurements and specifications

3

Summary and outlook

Table of content

1

Introduction

2

Measurements and specifications

3

Summary and outlook

Introduction

Introduction

- > This Infineon evaluation board (EVAL_1K6W_PSU_G7_DD) represents a complete system solution for a 1600 W server power supply (PSU), which achieves the **80Plus® Titanium® standard**. The power supply is composed of a continuous conduction mode (CCM) bridgeless power factor corrector (PFC) using a bi-directional switch and a half-bridge LLC DC-DC resonant converter.
- > To achieve the high efficiency results the evaluation board features several Infineon key components:
 - > 600 V CoolMOS™ G7 superjunction MOSFET
 - > CoolSiC™ Schottky diode 650 V G6
 - > OptiMOS™ 6 40 V MOSFET
 - > 1EDI20N12AF isolated and 2EDN7524F non-isolated gate drivers (EiceDRIVER™)
 - > XMC1402 and XMC4200 microcontrollers
 - > CoolSET™ quasi-resonant flyback controller

Summary of features:

- > Input voltage: 176-265 V_{ac}
- > Output voltage: 12.2 V_{dc}
- > Output power: 1600 W
- > Switching frequency: PFC 65 kHz
LLC 160 kHz (resonant frequency)
- > Peak efficiency: 96%

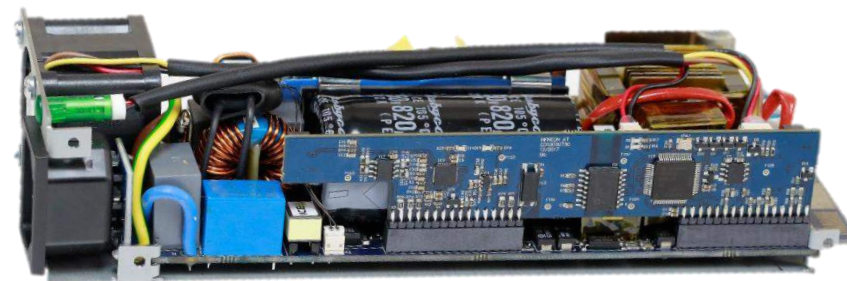

Introduction

Simplified diagram

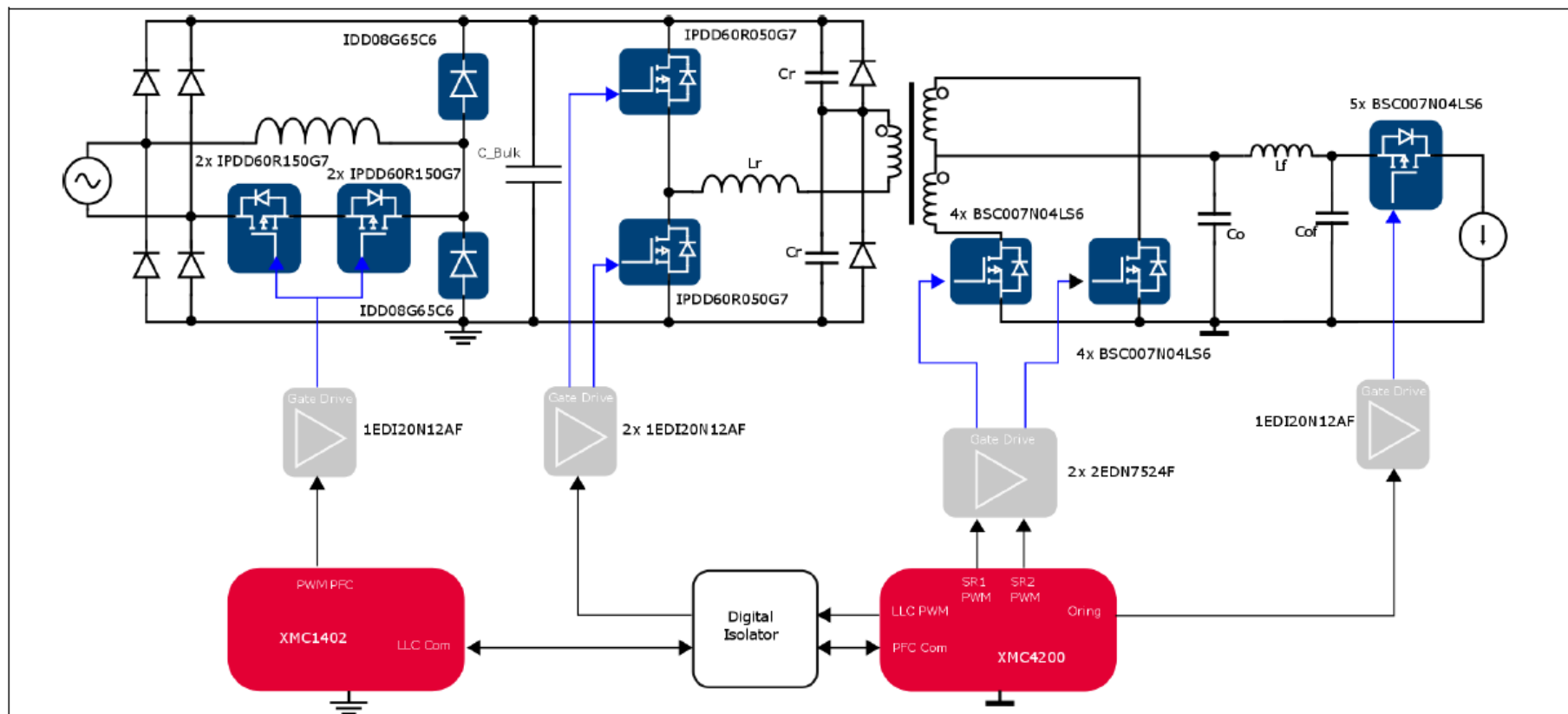

Introduction

Placement of the different sections in the 1600 W PSU with Infineon's CoolMOS™ and CoolSiC™ products in Double DPAK (DDPAK) package

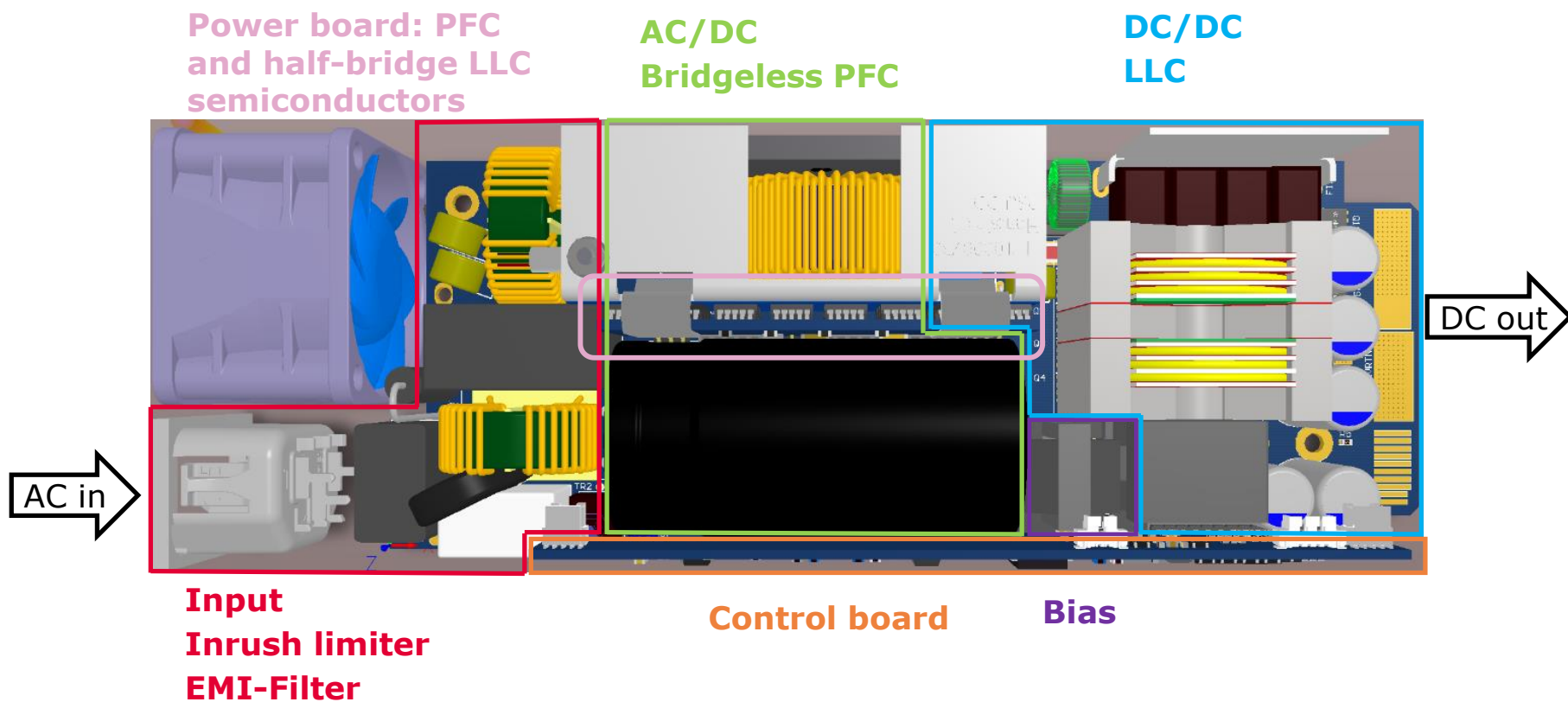

Introduction

Power module: PFC and half-bridge LLC semiconductors

Mounting scheme for the DDPAK Infineon semiconductors in the PFC and half-bridge LLC configuration is shown below:

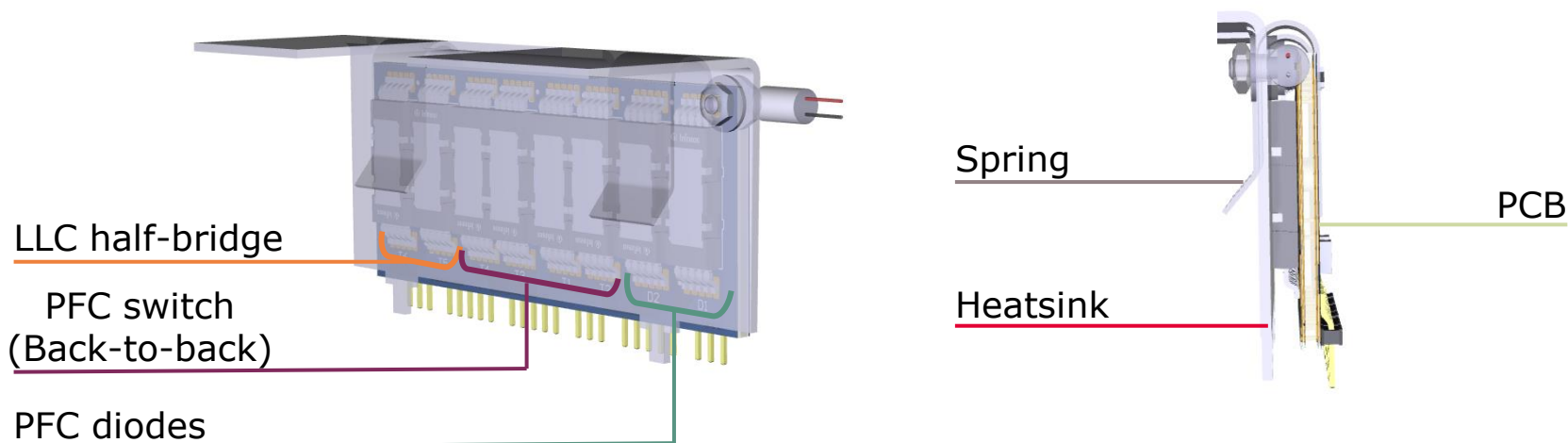

- > The power board integrates eight DDPAK semiconductors - CoolMOS™ G7 switches and CoolSiC™ G6 Schottky diodes used for the PFC, in combination with the CoolMOS™ G7 half-bridge switches for the LLC
- > It is designed for mass production as a single module by using a customized copper heatsink with a tinned surface and isolation foil which provides thermal conductivity and electrical isolation
- > The module is soldered vertically into the main PCB of the PSU and positioned in front of the fan to optimize airflow.

Table of content

1

Introduction

2

Measurements and specifications

3

Summary and outlook

Measurements and specifications

Summary of specifications and test conditions for the 1600 W PSU

Test		Conditions	Specification	
Efficiency test		230Vrms 50Hz/60Hz, 10% to 100% load	80Plus® Titanium® efficiency. $\eta_{pk} = 96\%$ at 800W (50% load)	
Current THD		230Vrms 50Hz/60Hz, 10% to 100% load	THDi < 10% from 20% load	
Power factor		230Vrms 50Hz/60Hz, 10% to 100% load	PF > 0.95 from 20% load	
Output voltage			12.2V	
Steady state Vout ripple		230Vrms 50/60Hz, 10% to 100% load	$ \Delta V_{out} < 120$ mVpk-pk	
Inrush current		230Vrms, 50Hz/60Hz, measured on the first AC cycle	lin_peak < 30A	
Power line disturbance	AC lost (Hold-up time)	230Vrms 50Hz, 10ms at 100% load, 20ms at 50% load	$ \Delta V_{out} < 240$ mVpk	No damage: * PSU soft start if bulk voltage under 310V * PSU soft start if Vac out of range for certain time
	Voltage sag	200Vrms 50Hz/60Hz, Different sag conditions; 100% load		
Brown out			174V ON; 168V OFF	
Load transient		1 A ↔ 66 A, 0.5 A/μs 66 A ↔ 133 A, 0.5 A/μs	$ \Delta V_{out} < 240$ mVpk	
Over current protection		30 s at 141 A 10 s at 149 A 1ms at 168 A Output terminals in shortcircuit	LLC OFF. Resume of operation requires bulk voltage to drop under 310V Detection within switching cycle. Resume of operation requires bulk voltage to drop under 310V	
EMI		230Vrms 50Hz, full load, resistive load, lab set-up	Complies with Class B limits	

Measurements and specifications

Efficiency results

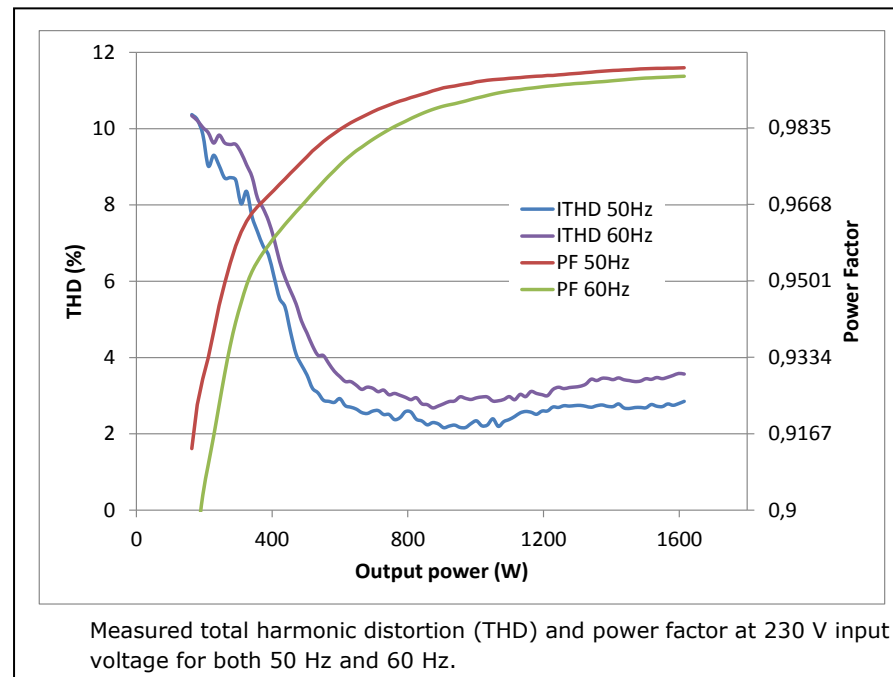
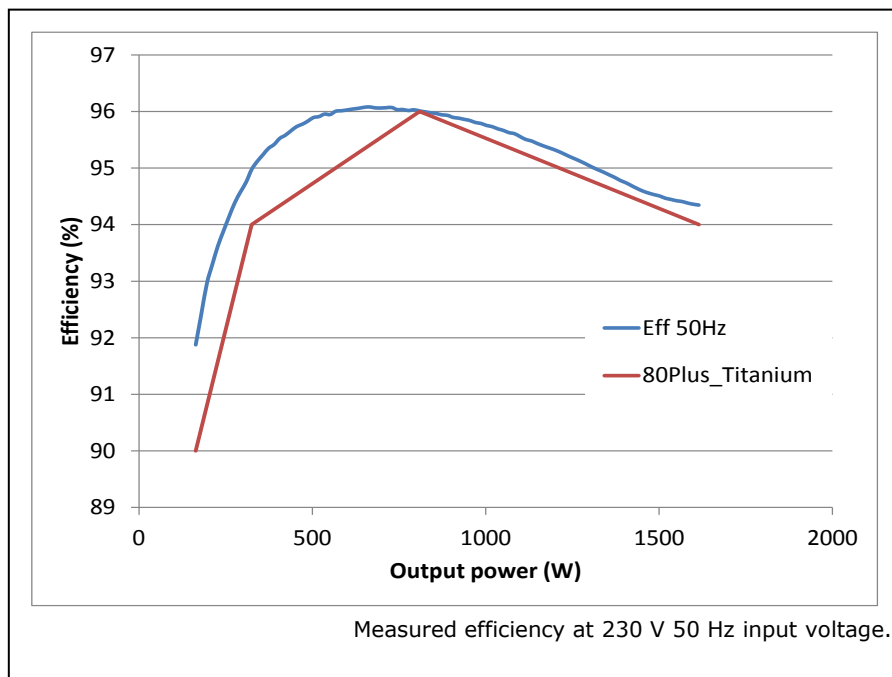

Table of content

1

Introduction

2

Efficiency results

3

Summary and outlook

Summary and outlook

- › The trend in the field of switched mode power supplies (SMPS) is a move towards power density and optimized cost. To reach the required higher power density levels, heat dissipation must be minimized, making efficiency key parameter in the process
- › The 800 W server power supply [EVAL_800W_PSU_3P_P7](#) and [EVAL_800W_PSU_4P_C7](#) evaluation boards developed with Infineon semiconductors, are great examples how to achieve high efficiency, similar to the 80Plus® Platinum® efficiency standards
- › Infineon's new **EVAL_1K6W_PSU_G7_DD PSU** evaluation board keeps the same form factor as the previously described 800W server PSU, while providing twice the power. Therefore, the power density increased to 44 W/in³ in the 1600 W design
- › There is always a relationship between form factor and increasing power density. Reducing the heat dissipation is a result of higher efficiency
- › *This server power supply allows the implementation and test of future Infineon devices and technologies. Further modifications of the presented power supply will be possible by updating different Infineon products such as EiceDRIVER™ 2EDF isolated drivers for the LLC stage, 5th generation CoolSET™ in the bias supply or CoolMOS™ as a relay replacement. In the case of OptiMOS™ 6, those who would like more information are requested to check the Infineon website*

Summary and outlook

Dimension

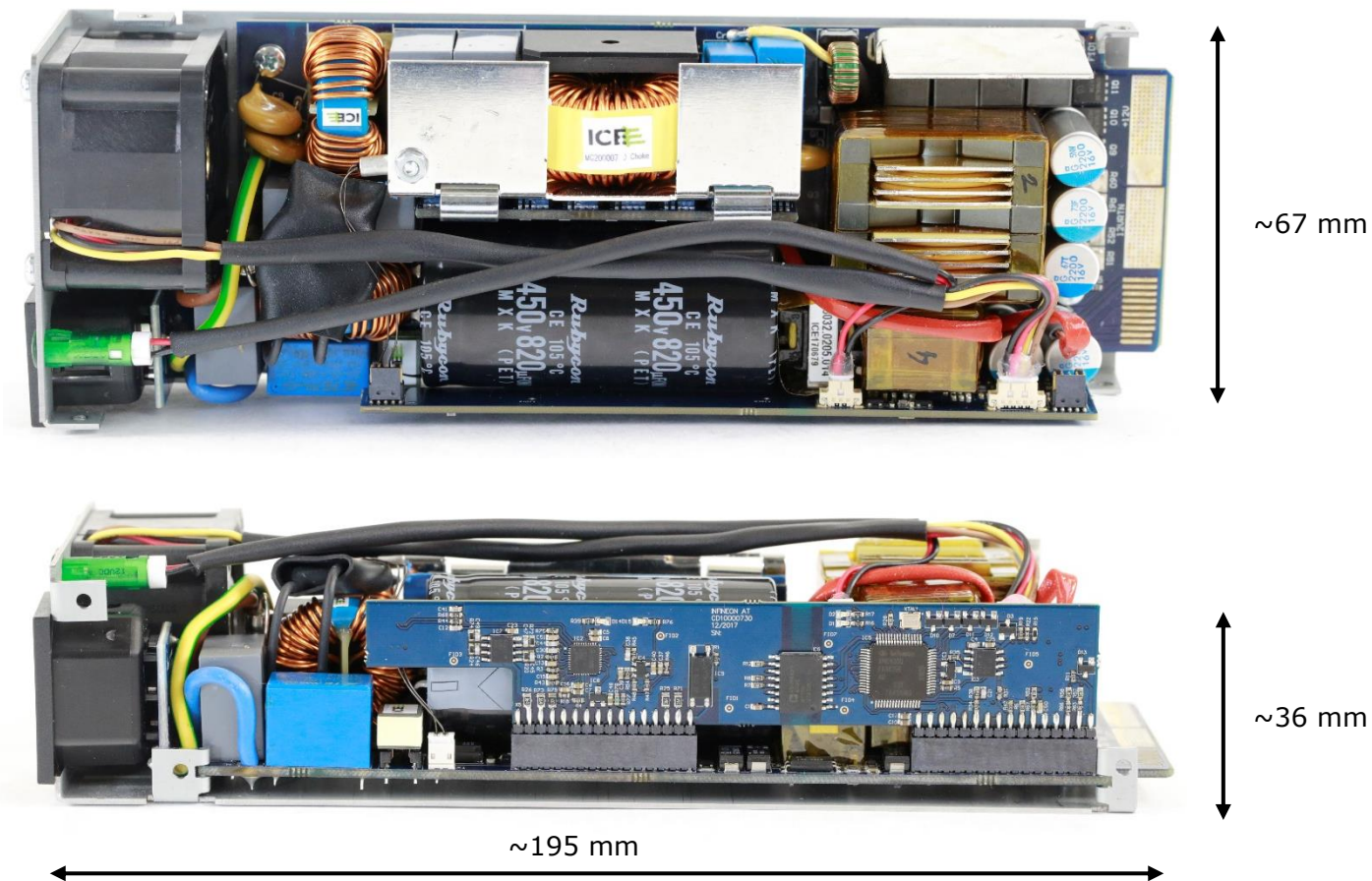



<h2>Technical Material</h2>	<ul style="list-style-type: none">> Application Notes> Datasheets	<ul style="list-style-type: none">> https://www.infineon.com/eval-1k6w-psu-g7-dd
<h2>Evaluation Boards</h2>	<ul style="list-style-type: none">> Evaluation Boards> Demoboards> Reference Designs	<ul style="list-style-type: none">> www.infineon.com/evaluationboards
<h2>Videos</h2>	<ul style="list-style-type: none">> Technical Videos> Product Information Videos	<ul style="list-style-type: none">> www.infineon.com/mediacenter

Support Online tools and services



- 1 **Subscribe to Newsletter**
- 2 **Where to Buy**
- 3 **Tools, Finders and Selectors**
- 4 **Support**

- Products
 - Applications
 - Tools
 - Support (4)
 - Technology
- Power
 - Automotive System IC
 - ESD & EMI
 - Microcontroller
 - RF & Wireless Control
 - Security IC
 - Sensor
 - Smart Card IC
 - Interface
 - Transistor & Diode
- Power Overview
 - Power MOSFET
 - IGBT
 - Smart Low-Side & High-Side Switches
 - Linear Voltage Regulator
 - DC-DC Converter
 - LED Driver | Lighting ICs
 - Silicon Carbide (SiC)
 - High Power Thyristors & Diodes
 - Motor Control & Gate Driver
 - AC-DC Supply

News & Tweets



Part of your life. Part of tomorrow.

