

"Schutzvermerk nach DIN ISO 16616 beachten" - "Please pay attention to copyright note DIN ISO 16616"

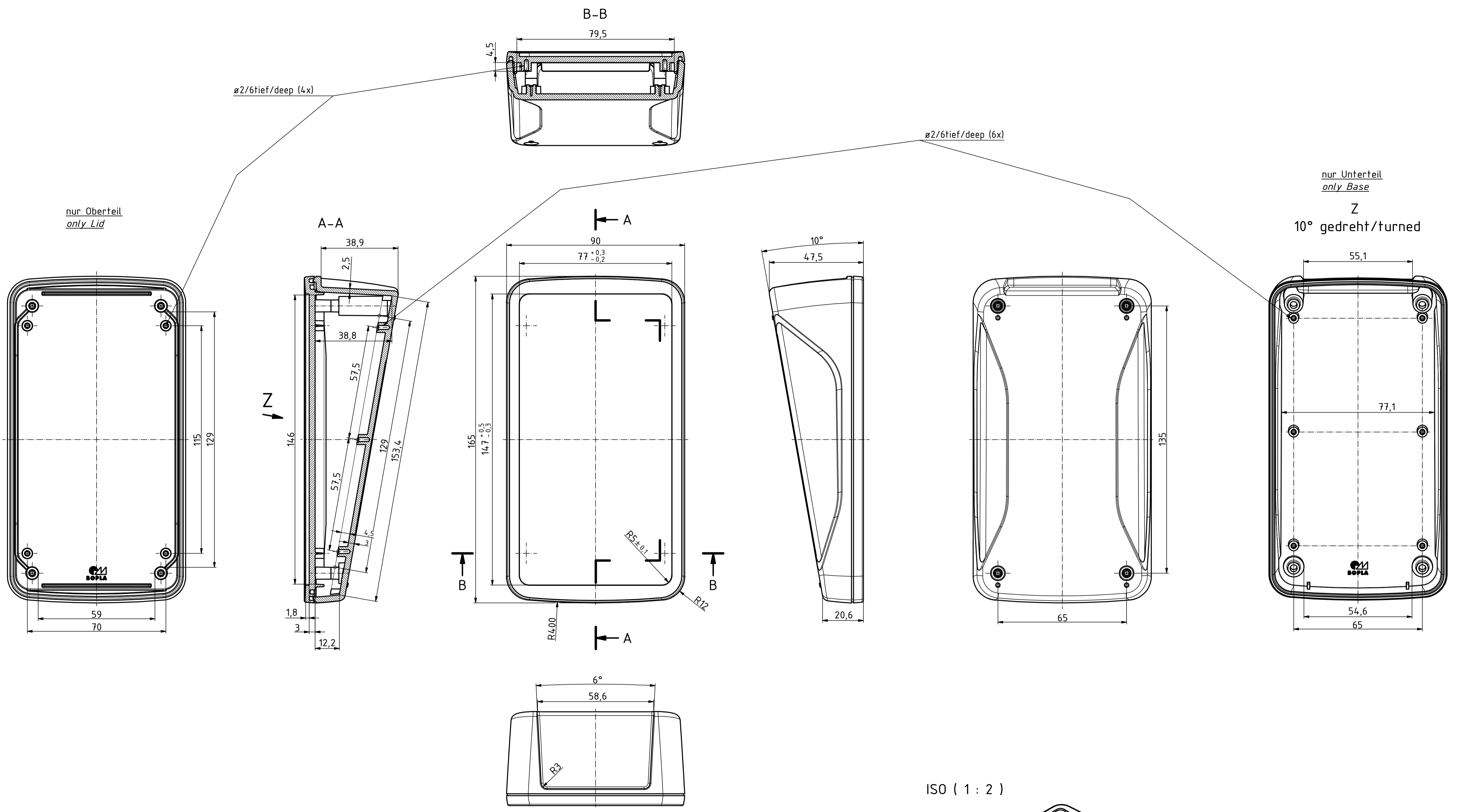

Maßstab/ Scale:		1:1 (1:2)	
Zeichnungs-Nr. / Drawing-No.:		1K 54.35.051.02	
Artikel / Article: BoPad BOP 700 PH Katalogzeichnung			
4232	20.10.2017		
A.Nr./ Art.No.:	Datum/ Date:		
DISK:		2803980.idw	
Datum/Date:		28.07.2016 KH	
		A Phoenix Mecano Company	