

TECHNICAL CHARACTERISTICS

MATERIAL  
 INSULATOR: NYLON 66  
 FLAMABILITY RATING: UL94-V0  
 COLOR: WHITE  
 CONTACT MATERIAL: COPPER ALLOY  
 CONTACT TYPE: STAMPED  
 CONTACT PLATING: TIN  
 QUALITY CLASS: 25 MATING CYCLES  
 PITCH: 4.20 MM

ENVIRONMENTAL  
 OPERATING TEMPERATURE: -40 UP TO 105°C  
 COMPLIANCE: LEAD FREE AND ROHS

ELECTRICAL  
 CURRENT RATING: 6 TO 9 A

NB CIRCUITS	2-3	4-6	7-10	12-24
AMPERES	9	8	7	6

WORKING VOLTAGE: 600 VAC  
 INSULATOR RESISTANCE: >1000 MOHM  
 DIELECTRIC WITHSTANDING VOLTAGE: 1500 VAC/MN  
 CONTACT RESISTANCE: 10 MOHM MAX

STANDARD  
 CERTIFIED: E323964

SOLDERING  
 JEDEC LEAD FREE WAVE SOLDERING PROCESS

PACKAGING  
 TRAY

DIMENSION  
 A = 4.20 x (NB. PIN / 2 - 1)  
 B = 4.20 x (NB. PIN / 2) + 1.30

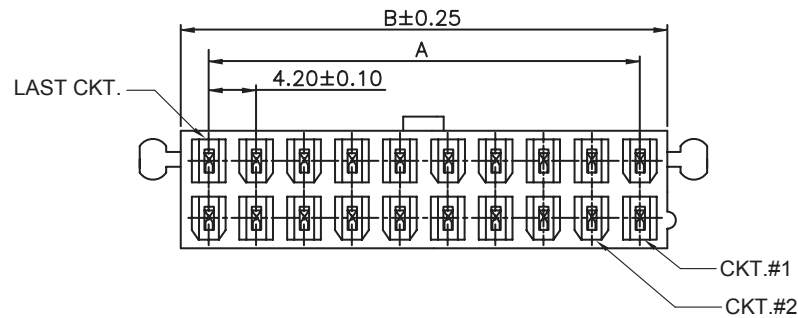
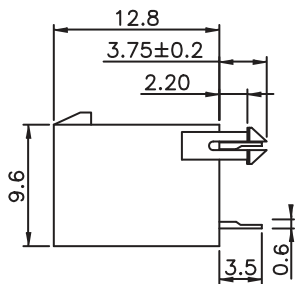
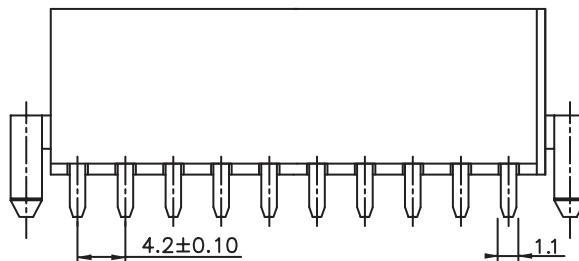

RoHS Compliant

G			
F			
E	25-APR-16	TPK	AK
D	01-JUL-15	PINNING	AK
C	13-FEB-14	CORRECTIONS	QL
B	18-NOV-09	STANDARD	JP
A	23-AVR-09	PACKAGING	JC
REV	DATE	FILE	BY

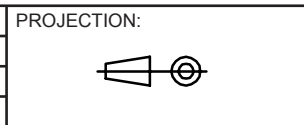

GENERAL TOLERANCE  
 .X = +/- 0.2  
 .XX = +/- 0.15

APPROVAL: BBu

UNIT: MM  
 SCALE:  
 SHEET: 1/3  
 DRAW: CEL KING



DESCRIPTION: 4.20MM MALE DUAL ROW VERTICAL HEADER WITH MOUNTING PEGS  
 WERI PART NO: 649 0xx 221 732

SIZE  
**A4**

1

2

3

4

5

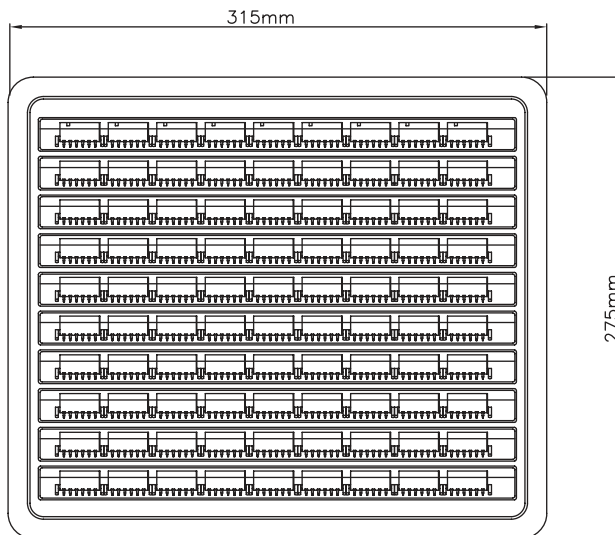
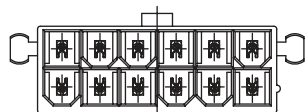
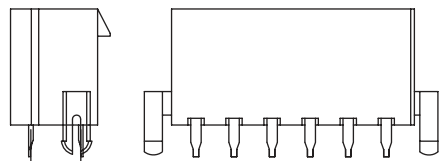

Note:

02Pin

1.Dimension

Tray Size:260(L)\*185(W)\*11.5(H) (mm)

Inner Carton Size:254(L)\*190(W)\*260(H) (mm)

Carton Size:400\*280\*280 (mm)

2.Quantity

17 Trays/Inner Carton

2 Inner Carton/Carton

04~24Pin

1.Dimension:

Tray Size: 315(L)x275(W)x14.5(H) (mm)

Carton Size: 322(L)x285(W)x350(H) (mm)

2.Quantity:

30Tray/Carton

Pin.	Pcs/Tray	Tray/Carton	Pcs/Carton
2	170	34	5780
4	170	30	5100
6	130	30	3900
8	110	30	3300
10	90	30	2700
12	80	30	2400
14	70	30	2100
16	60	30	1800
18	60	30	1800
20	50	30	1500
22	50	30	1500
24	40	30	1200

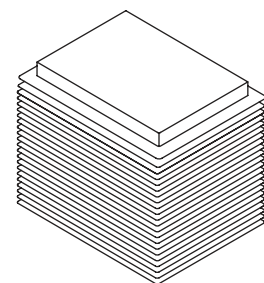
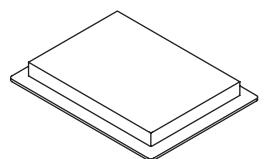

TRAYS

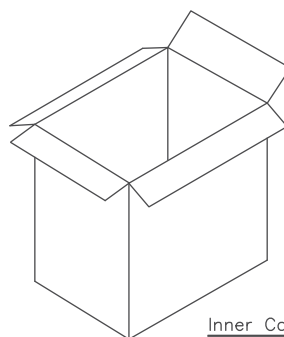

Inner Carton

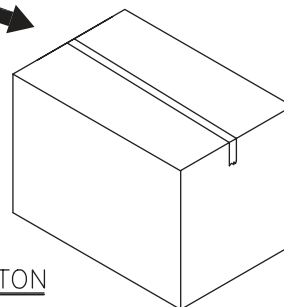

CARTON

RoHS Compliant

PROJECTION:



GENERAL TOLERANCE

.X = +/- 0.2

.XX = +/- 0.15



APPROVAL: BBU

UNIT: MM

SCALE:

SHEET: 2/3

DRAW: PEARL

DESCRIPTION: 4.20MM MALE DUAL ROW VERTICAL HEADER WITH MOUNTING PEGS

WERI PART NO: 649 0xx 221 732

SIZE

A4

G			
F			
E			
D			
C			
B			
A			
REV	DATE	FILE	BY

1

2

3

4

5

## Cautions and Warnings:

This electronic component is designed and developed with the intention for use in general electronics equipments.

Before incorporating the components into any equipments in the field such as aerospace, aviation, nuclear control, submarine, transportation, (automotive control, train control, ship control), transportation signal, disaster prevention, medical, public information network etc. where higher safety and reliability are especially required or if there is possibility of direct damage or injury to human body, Würth Elektronik must be asked for a written approval.

In addition, even electronic component in general electronic equipments, when used in electrical circuits that require high safety, reliability functions or performance, the sufficient reliability evaluation-check for the safety must be performed before by the user before usage.

A

B

C

RoHS Compliant

G				PROJECTION: 	GENERAL TOLERANCE .X = +/- 0.2 .XX = +/- 0.15		
F							
E							
D							
C				APPROVAL: JC	UNIT: MM	DESCRIPTION: DISCLAIMER	SIZE <b>A4</b>
B					SCALE:		
A	10-SEP-14	PDF	QL		SHEET: 3/3	WERI PART NO: DISCLAIMER	
REV	DATE	FILE	BY		DRAW: QL		

D