

**Chip Ferrite Bead BLM18AG□□□WH1D Reference Specification**

**1.Scope**

This reference specification applies to Chip Ferrite Bead for Automotive Electronics BLM18AG\_WH Series.

**2.Part Numbering**

(ex.)  $\frac{BL}{(1)} \frac{M}{(2)} \frac{18}{(3)} \frac{AG}{(4)} \frac{471}{(5)} \frac{W}{(6)} \frac{H}{(7)} \frac{1}{(8)} \frac{D}{(9)}$

(1)Product ID (2)Type (3)Dimension(L×W) (4)Characteristics (5)Typical Impedance at 100MHz  
 (6)Performance(for Conductive Glue) (7)Category(for Automotive Electronics) (8)Numbers of Circuit  
 (9)Packaging(Taping)

**3.Rating**

Customer Part Number	MURATA Part Number	Impedance (Ω) (at 100MHz, Under Standard Testing Condition)		Rated Current (mA) (at +125°C)	DC Resistance (Ω)	
			Typical		Initial Values	Values After Testing
	BLM18AG471WH1D	470±25%	470	1000*	0.20 max.	0.26 max.
	BLM18AG102WH1D	1000±25%	1000	200*	0.70 max.	0.8 max.

- Operating Temperature : -55°C to +150°C
- Storage Temperature : -55°C to +125°C

\* Rated current is derated as shown in the right figure depending on the operating temperature.

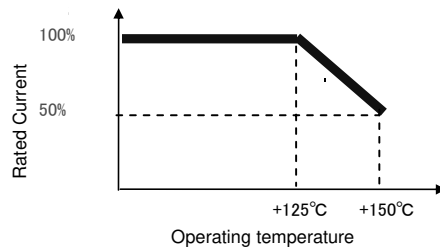

**4.Style and Dimensions**

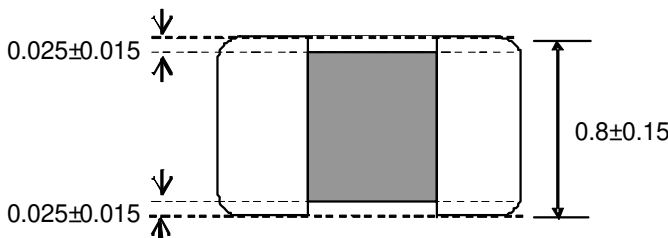
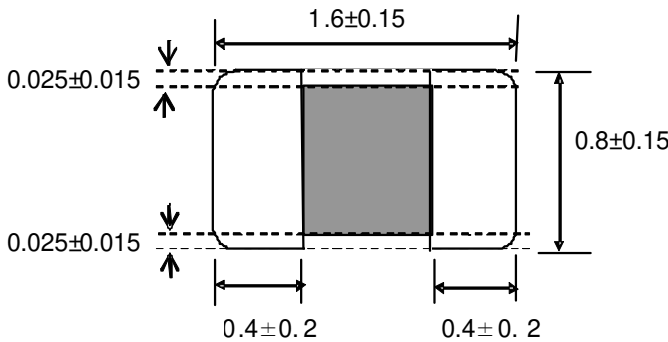

■ Equivalent Circuit

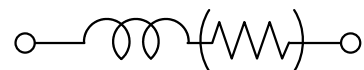

( Resistance element becomes dominant at high frequencies. )

(Unit : mm)

**5.Marking**

No marking.

**6.Standard Testing Conditions**

&lt; Unless otherwise specified &gt;

Temperature : Ordinary Temp. (15 °C to 35 °C)

Humidity : Ordinary Humidity (25%(RH) to 85%(RH))

&lt; In case of doubt &gt;

Temperature : 20°C±2 °C

Humidity : 60%(RH) to 70%(RH)

Atmospheric pressure : 86kPa to 106kPa

**7.Specifications****7-1.Electrical Performance**

No.	Item	Specification	Test Method
7-1-1	Impedance	Meet item 3.	Measuring Frequency : 100MHz±1MHz Measuring Equipment : Agilent 4291A or the equivalent Test Fixture : Agilent 16192A or the equivalent
7-1-2	DC Resistance	Meet item 3.	Measuring Equipment : Digital multi meter

**7-2. Test Item**

It shall be mounted on the substrate with conductive glue for Mechanical and Environmental Performance.

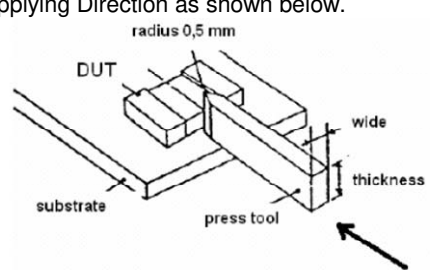
No.	Item	Specification	Test Method						
7-2-1	High Temperature Exposure	Meet Table A after testing. Table A <table border="1"> <tr> <td>Appearance</td> <td>No damage</td> </tr> <tr> <td>Impedance Change (at 100MHz)</td> <td>Within ±30%</td> </tr> <tr> <td>DC Resistance</td> <td>Meet item 3.</td> </tr> </table>	Appearance	No damage	Impedance Change (at 100MHz)	Within ±30%	DC Resistance	Meet item 3.	1000hours at 150 deg C Set for 24hours at room temperature, then measured.
Appearance	No damage								
Impedance Change (at 100MHz)	Within ±30%								
DC Resistance	Meet item 3.								
7-2-2	Temperature Cycling	Meet Table A after testing.	Per JESD22 Method JA-104 1000cycles (-55 deg C to +150 deg C) Set for 24hours at room temperature, then measured.						
7-2-3	Biased Humidity	Meet Table A after testing.	1000hours at 85 deg C, 85%RH Apply rated current.						
7-2-4	Operational Life	Meet Table A after testing.	Apply rated current at 150 deg C 1000hours. Set for 24hours at room temperature, then measured.						
7-2-5	Mechanical Shock	Meet Table A after testing.	Per MIL-STD-202 Method 213 1500g's (14.7N)/0.5ms/, Half sine						
7-2-6	Vibration	Meet Table A after testing.	5g's(0.049N, 49m/s <sup>2</sup> ) for 20 minutes, 12cycles each of 3 orientations Test from 10-2000Hz.						
7-2-7	Thermal Shock	Meet Table A after testing.	1000cycles (-55 deg C to +150 deg C) Max transfer time, 20s						
7-2-8	ESD	Meet Table A after testing.	Per AEC-Q200-002 Cd:150pF, Rd:2000ohm, +/-500V, 1time each						
7-2-9	Terminal Strength (SMD)	Meet Table A after testing.	Applying Force : 4.8N Applying Time : 5s±1s Applying Direction as shown below. 						



(5)Outside package

These reels shall be packed in the corrugated cardboard package and the following items shall be marked on a label and the label is stuck on the box.

(Customer name, Purchasing order number, Customer part number, MURATA part number, RoHS discrimination(\*2) ,Quantity, etc)

(6)Dimensions of reel and taping(leader-tape, trailer-tape)

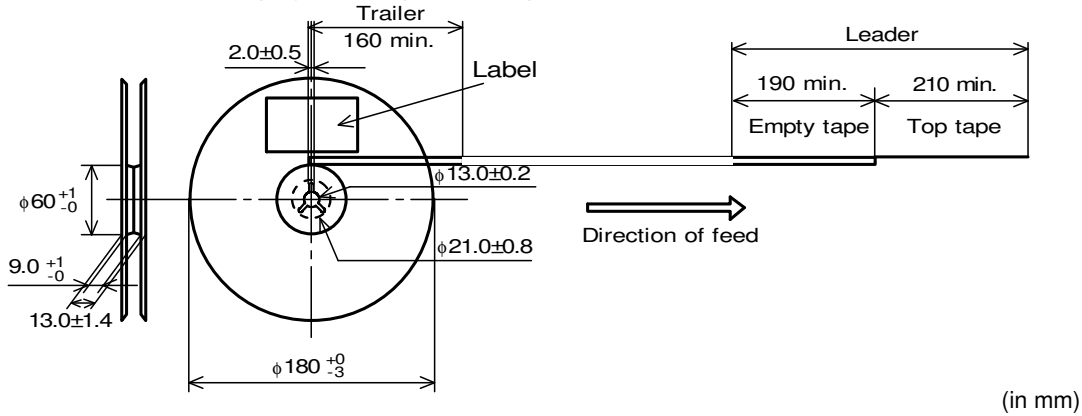

**8-4. Specification of Outer Case**

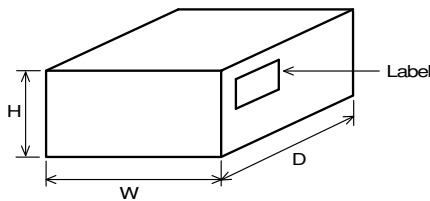

Outer Case Dimensions (mm)			Standard Reel Quantity in Outer Case (Reel)
W	D	H	
186	186	93	5

\* Above Outer Case size is typical. It depends on a quantity of an order.

**9. ⚠ Caution**

**9-1.Limitation of Applications**

Please contact us before using our products for the applications listed below which require especially high reliability for the prevention of defects which might directly cause damage to the third party's life, body or property.

- |                                  |  |
|----------------------------------|--|
| (1)Aircraft equipment            | (6)Disaster prevention / crime prevention equipment  |
| (2)Aerospace equipment           | (7)Traffic signal equipment  |
| (3)Undersea equipment            | (8)Transportation equipment (trains,ships,etc.)  |
| (4)Power plant control equipment | (9)Applications of similar complexity and /or reliability requirements to the applications listed in the above |
| (5)Medical equipment             |  |

**9-2. Caution for product's ratings**

Don't use our products over their rating current, Because it may make the deterioration of their electric characteristics. In worst case, it may cause smoke from the adhesive because of the excessive heat and open circuit.

**9-3. Operating Environment**

- (1)Don't use our products over the operating temperature, Because it may make the deterioration of their electric characteristics. In worst case, it may cause smoke from the adhesive because of the excessive heat.
- (2)Do not use this product in the corrodible atmosphere (acidic gases, alkaline gases, chlorine, sulfur gases, organic gases and etc.), because the atmosphere may cause deterioration of the electrical characteristic because of the corrosion of the inner electrodes and outer electrodes and deterioration of the adhesive.

**9-4. Mounting Density**

Add special attention to radiating heat of some products with heating when mounting our product near the products. The excessive heat by other products may cause deterioration of our product's characteristics or incorrect operation, so be sure to use our product under the operating temperature including the heat from other products.

**9-5. Addition fail-safe function to your products**

Be sure to add an appropriate fail-safe function on your product to prevent a second damage that may be caused by the abnormal function or the failure of our product.

**10. Notice**

This product is designed for adhesive with conductive glue, so we can't guarantee for other connecting method. If you plan to take another connecting method, please contact us.

**10-1. How to mount this product on a board with conductive glue**

Please refer to the figure and table below which shows the method of recommended mounting with conductive glue. ( We recommend using a mounting machine to mount this product.)

Please coat print pads with recommended conductive glue "PC3000" manufactured by Heraeus with using metal mask and metal squeegee, and then mount our products on the substrates with a mount machine or human hand. Please put the substrates into a oven (140~150 °C) for 30 minutes in order to cure the adhesive. Please check whether the chips and the substrates are connected with the conductive glue or not and there is no electrically short of the conductive glue.

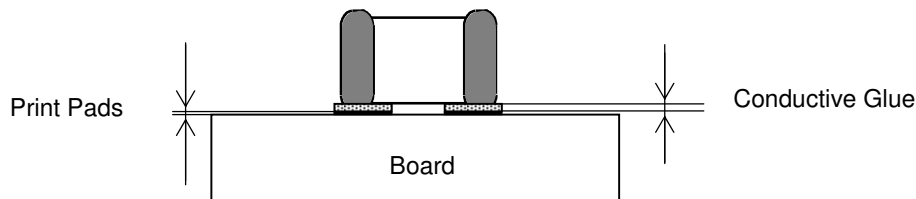

①Board	Ceramic Board or Alumina Board
②Thickness of Glue	30~50 μ m
③Recommended Conductive Glue	PC3000 (Manufactured by Heraeus)

**10-2.Storage Conditions**

## (1)Storage period

Use the products within 6 months after delivered.

Adhesive performance should be checked if this period is exceeded.

## (2)Storage conditions

- Products should be stored in the warehouse on the following conditions.

Temperature : -10°C to 40°C

Humidity : 15% to 85% relative humidity

No rapid change on temperature and humidity

- Don't keep products in corrosive gases such as sulfur, chlorine gas or acid, or it may cause oxidization of electrode, resulting in poor adhesive strength.
- Products should be stored on the palette for the prevention of the influence from humidity, dust and so on.
- Products should be stored in the warehouse without heat shock, vibration, direct sunlight and so on.
- Products should be stored under the airtight packaged condition.

## (3)Delivery

Care should be taken when transporting or handling product to avoid excessive vibration or mechanical shock.

**11. ⚠ Note**

(1)Please make sure that your product has been evaluated in view of your specifications with our product being mounted to your product.

(2)You are requested not to use our product deviating from the reference specifications.

(3)The contents of this reference specification are subject to change without advance notice. Please approve our product specifications or transact the approval sheet for product specifications before ordering.