

THIS COPY IS PROVIDED ON A RESTRICTED BASIS AND IS NOT TO BE USED IN ANY WAY DETRIMENTAL TO THE INTERESTS OF PANDUIT CORP.

PANDUIT PART NO.	WEIGHT lbs 10 (g) pcs
JP4WP-___	0.59 (267.62)

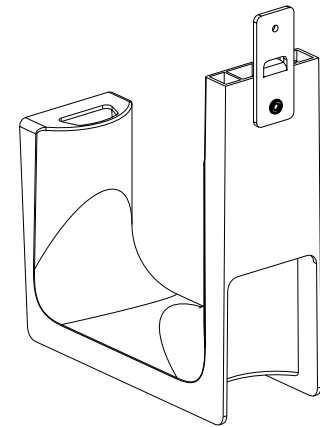
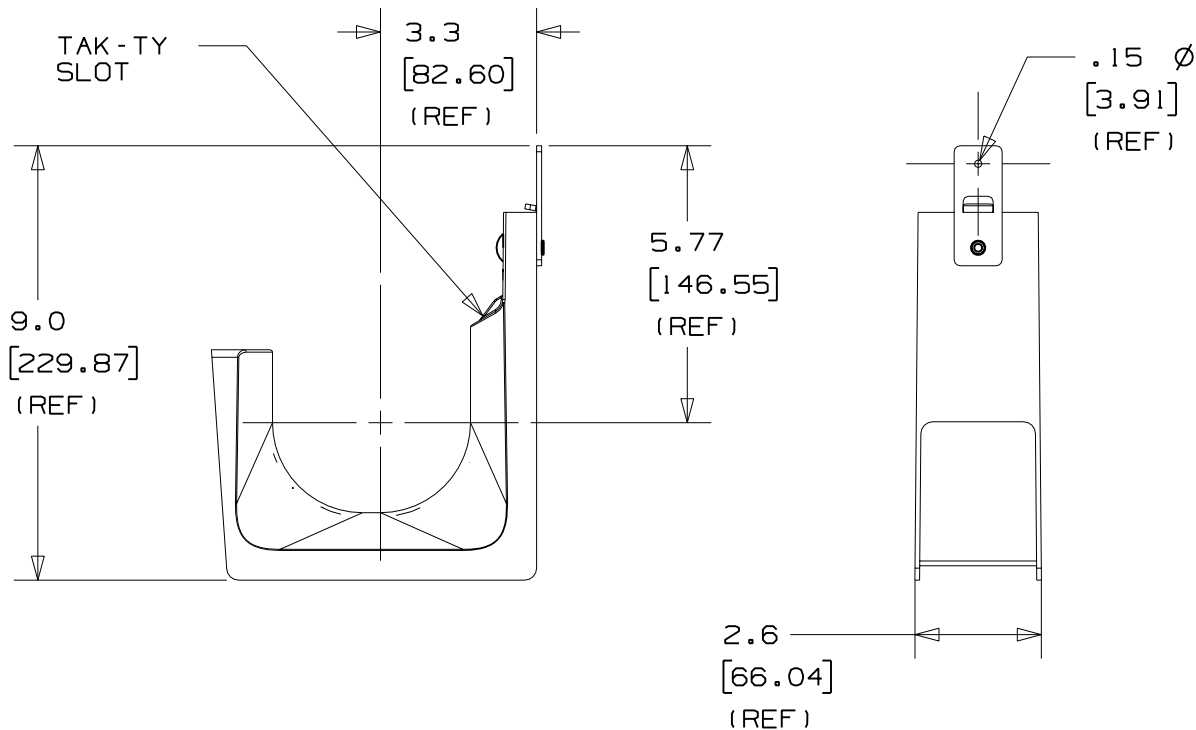

NOTES:

- SEE CURRENT PRICE SHEET FOR PART NUMBER SUFFIX DESIGNATION FOR PACKAGE SIZE AND PRODUCT COLOR.
- HOOK MATERIAL: 33% GLASS FILLED NYLON 6/6
PLATE MATERIAL: PRE-GALVANIZED STEEL
RIVET MATERIAL: ALUMINUM
- PRODUCT IS DESIGNED TO SUPPORT A MAXIMUM OF 4.0" (101.6) DIAMETER BUNDLE. MAXIMUM RECOMMENDED STATIC LOAD: 100 lbs.
- PRODUCT INCORPORATES FEATURES ALLOWING USER TO RETAIN CABLE BUNDLES IN J-PRO J-HOOK WITH TAK-TY CABLE TIES UP TO 3/4" WIDE.
- PRODUCT MARKINGS:
cULus logo and statement:
"SUITABLE FOR USE IN AIR HANDLING SPACES IN ACCORDANCE WITH SECTION 300-22 (C) & (D) OF THE NATIONAL ELECTRIC CODE."
ULC logo and statement:
"IN ACCORDANCE WITH CAN/ULC S-102.2 IN SINGLE UNITS OR PAIRS, 4 ft (1220mm) MIN. SPACING, FSR=0, SDC=20."

DIMENSIONS IN BRACKETS ARE METRIC [mm]	
CAD FILENAME/LAYERS G03043DM_PB_JP4WP_00	
<h1>PANDUIT</h1> CORP. TINLEY PARK, ILLINOIS	
J-PRO J-HOOK WITH PLATE FOR POWDER ACTUATED FASTENERS (JP4WP-___)	
UNLESS OTHERWISE SPECIFIED, DIMENSIONAL TOLERANCES ARE: (.X) ±0.05 (1.3) (.XXX) ±0.010 (0.25) (.XX) ±0.02 (0.5) ANGLES ± 5°	UNLESS OTHERWISE SPECIFIED, ALL DIMENSIONS ARE GIVEN IN INCHES, THIRD ANGLE PROJECTION.
DRAWN BY JAD	MAT'L: SEE NOTE 2
DATE 2/10/06	SCALE NONE
CHK'D	DRAWING NO. GB3043DM
	DWG SIZE A

R	2/10/06	JAD		INITIAL RELEASE	GB3043DM	R			
REV	DATE	BY	CHK	DESCRIPTION	ECN	R	CUST	SUP	