



TAOGLAS®



Datasheet

GWLA.10

Description:

GWLA.10– GPS/GALILEO & Dual-Band Wi-Fi Ceramic Loop Antenna
Embedded 2in1 Structure

Features:

Small Footprint Embedded Loop Antenna
Omnidirectional
High Efficiency
Multi-Band Application - 1575.42MHz GPS/GALILEO and 2.4/5.8GHz Wi-Fi
Two Separate Feeds on one Antenna
Low profile
Surface-Mount)
Dimensions: 3.2*1.6*0.5mm
RoHS & Reach Compliant

1. Introduction	3
2. Specifications	5
3. Antenna Characteristics	7
4. 2D Radiation Patterns	11
5. 3D Radiation Patterns	14
6. Mechanical Drawing - Antenna	15
7. Antenna Integration Guide	16
8. Mechanical Drawing – Evaluation Board	23
9. Matching Circuit	24
10. Soldering Conditions	25
11. Packaging	26
<hr/>	
Changelog	28

Taoglas makes no warranties based on the accuracy or completeness of the contents of this document and reserves the right to make changes to specifications and product descriptions at any time without notice. Taoglas reserves all rights to this document and the information contained herein. Reproduction, use or disclosure to third parties without express permission is strictly prohibited.



1. Introduction



The GWLA.10 GPS/GALILEO and 2.4/5.8GHz 2in1 Embedded Ceramic Loop antenna is a high efficiency, miniature SMD, edge mounted ceramic antenna for GPS/GALILEO and Wi-Fi, WLAN, ZigBee, Bluetooth, and 802.11ac applications where PCB space is limited, such as hand-held devices. Rather than using two separate chip antennas for GPS/GALILEO and Wi-Fi, the GWLA.10 has two separate antenna feeds in a single antenna body, making it the ideal choice for applications where there is limited PCB space and where low cost is important.

The GWLA.10 uses the main PCB as its ground plane, thereby maintaining good efficiency despite its small size. This compact size antenna can be tuned for different PCB sizes/environments by changing the values of the matching circuit. This needs to be carefully calculated, contact a regional Taoglas facility for support. Also be aware that smaller ground-planes will reduce the efficiency of the antenna.

At 3.2*1.6*0.5mm, the GWLA.10 is one of the smallest antennas available worldwide. This antenna is delivered on tape and reel and manufactured in a TS16949 first tier automotive approved facility.

The GPS/GALILEO performance is excellent, with high efficiency and an omnidirectional pattern. The Wi-Fi performance is also great and delivers stable efficiency and radiation pattern too, allowing this antenna to be used in a huge variety of devices.

Typical Applications – Where GPS/GALILEO and Dual-Band Wi-Fi are required

- Navigation or Position Tracking Systems
- Handheld Devices
- Tablets
- POS Systems
- Gateways and Routers
- Mobile Wireless Camera Systems
- OBD Devices

Many module manufacturers specify peak gain limits for any antennas that are to be connected to that module. Those peak gain limits are based on free-space conditions. In practice, the peak gain of an antenna tested in free-space can degrade by at least 1 or 2 dB when put inside a device. So ideally you should go for a slightly higher peak gain antenna than mentioned on the module specification to compensate for this effect, giving you better performance.

Upon testing of any of our antennas with your device and a selection of appropriate layout, integration technique, or cable, Taoglas can make sure any of our antennas' peak gain will be below the peak gain limits. Taoglas can then issue a specification and/or report for the selected antenna in your device that will clearly show it complying with the peak gain limits, so you can be assured you are meeting regulatory requirements for that module.

For example, a module manufacturer may state that the antenna must have less than 2 dBi peak gain, but you do not need to select an embedded antenna that has a peak gain of less than 2 dBi in free-space. This will give you a less optimized solution. It is better to go for a slightly higher free-space peak gain of 3 dBi or more if available. Once that antenna gets integrated into your device, performance will degrade below this 2 dBi peak gain due to the effects of GND plane, surrounding components, and device housing. If you want to be absolutely sure, contact Taoglas and we will test. Choosing a Taoglas antenna with a higher peak gain than specified by the module manufacturer and enlisting our help will ensure you are getting the best performance possible without exceeding the peak gain limits.

This antenna can be mounted with no performance degradation in either orientation as long as the antenna is soldered correctly via Surface mounting. Please see the integration instructions section for further detail regarding the optimum way to integrate this antenna into your device.

For further optimization to customer-specific device environments and for support to integrate and test this antennas performance in your device, contact your regional Taoglas Customer Services Team.

2. Specifications

GNSS Frequency Bands Covered						
GPS	L1	L2	L5	L6		
	■	■	■	■		
GLONASS	G1	G2	G3			
	■	■	■			
Galileo	E1	E5a	E5b	E6		
	■	■	■	■		
BeiDou	B1	B2a	B2b	B3		
	■	■	■	■		
QZSS (Regional)	L1	L2C	L5	L6		
	■	■	■	■		
IRNSS (Regional)	L5					
	■					
SBAS	L1/E1/B1	L5/B2a/E5a	G1	G2	G3	
	■	■	■	■	■	

*SBAS systems: WASS(L1/L5), EGNOS(E1/E5a), SDCM(G1/G2/G3), SNAS(B1/B2a), GAGAN(L1/L5), QZSS(L1/L5), KAZZ(L1/L5).

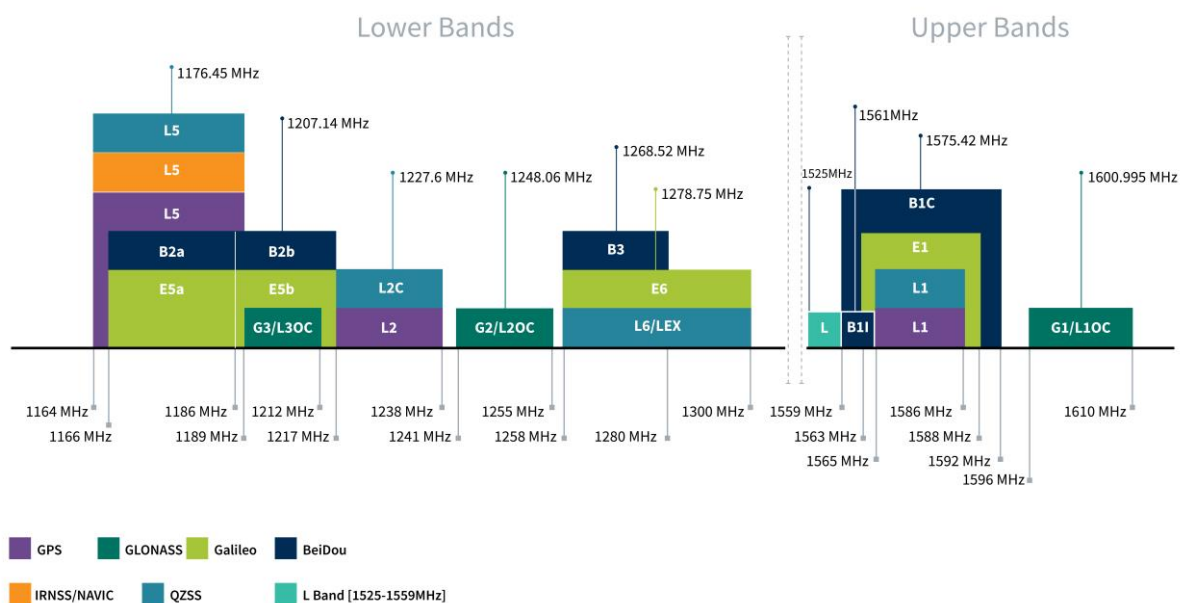

GNSS Bands and Constellations

Electrical*			
Application Bands	GPS/GALILEO Antenna	Wi-Fi Antenna	
Frequency (MHz)	1575.42	2400-2500	5150-5850
Bandwidth (MHz)	35 (RL<-10dB)	100 (RL<-10dB)	820 (RL<-6dB)
Peak Gain (dBi)	1.36	0.27	1.86
Efficiency (%)	57.06	51.25	53.56
Return Loss (dB)	< -10	< -10	< -6
Isolation (dB)	>15	>10	>25
Impedance		50Ω	
Polarization		Linear	
Input Power		2W	
Mechanical			
Dimensions	3.2*1.6*0.5mm		
Ground Plane	80*40mm (Standard Evaluation Board)		
Weight	0.02g		
Environmental			
Operating Temperature	-40°C to 85°C		
Storage Temperature	-40°C to 85°C		
Relative Humidity	20% to 70%		
Moisture Sensitivity Level (MSL)	3 (168 Hours)		

*Tested on 80*40mm evaluation board.

3. Antenna Characteristics

3.1 Return Loss - GPS/GALILEO Band

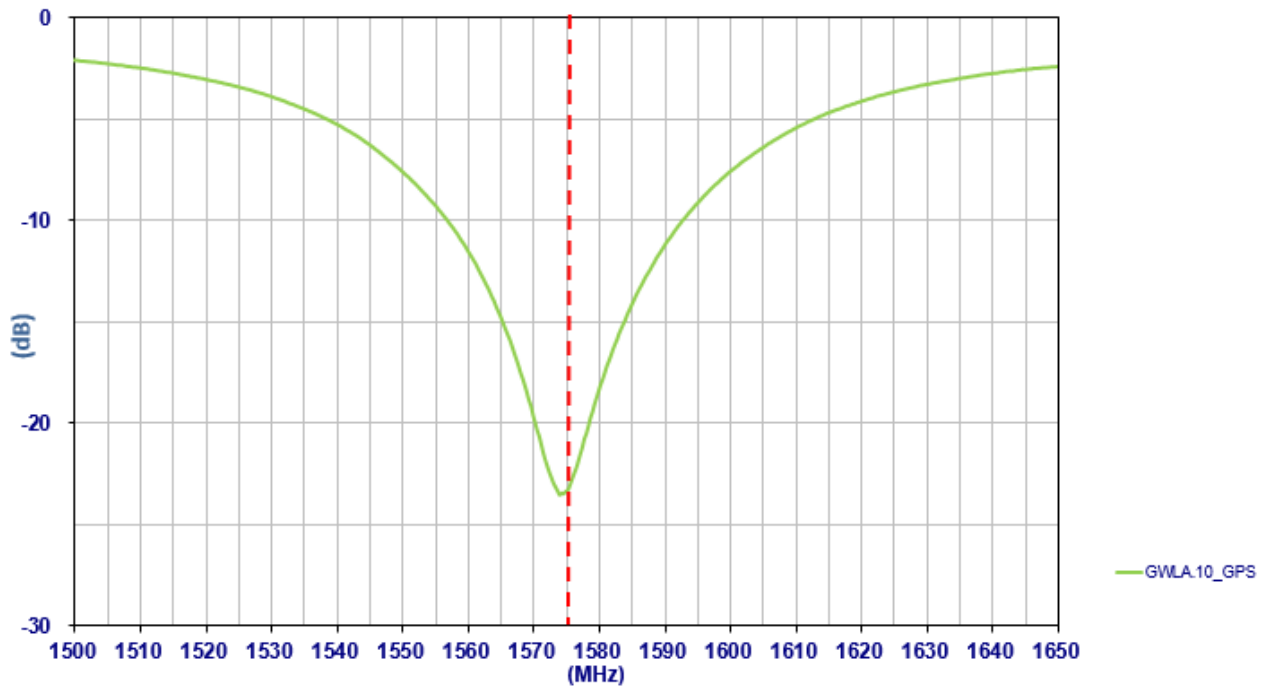

3.2 Efficiency - GPS/GALILEO Band

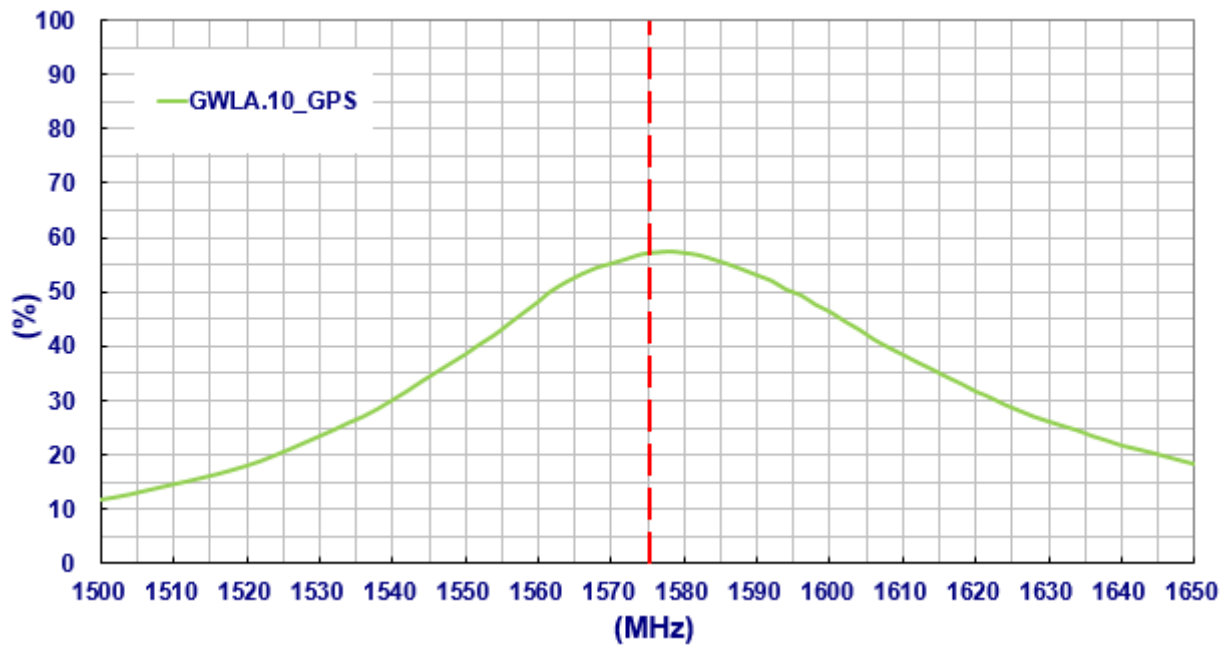

3.3 Peak Gain

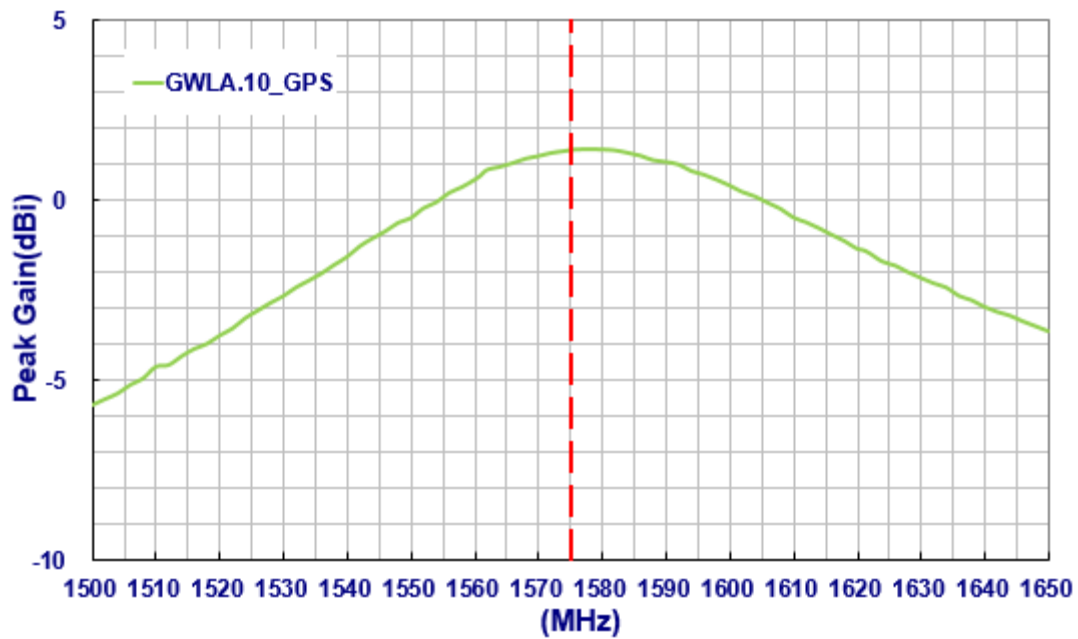

3.4 Return Loss - Wi-Fi Dual-Band

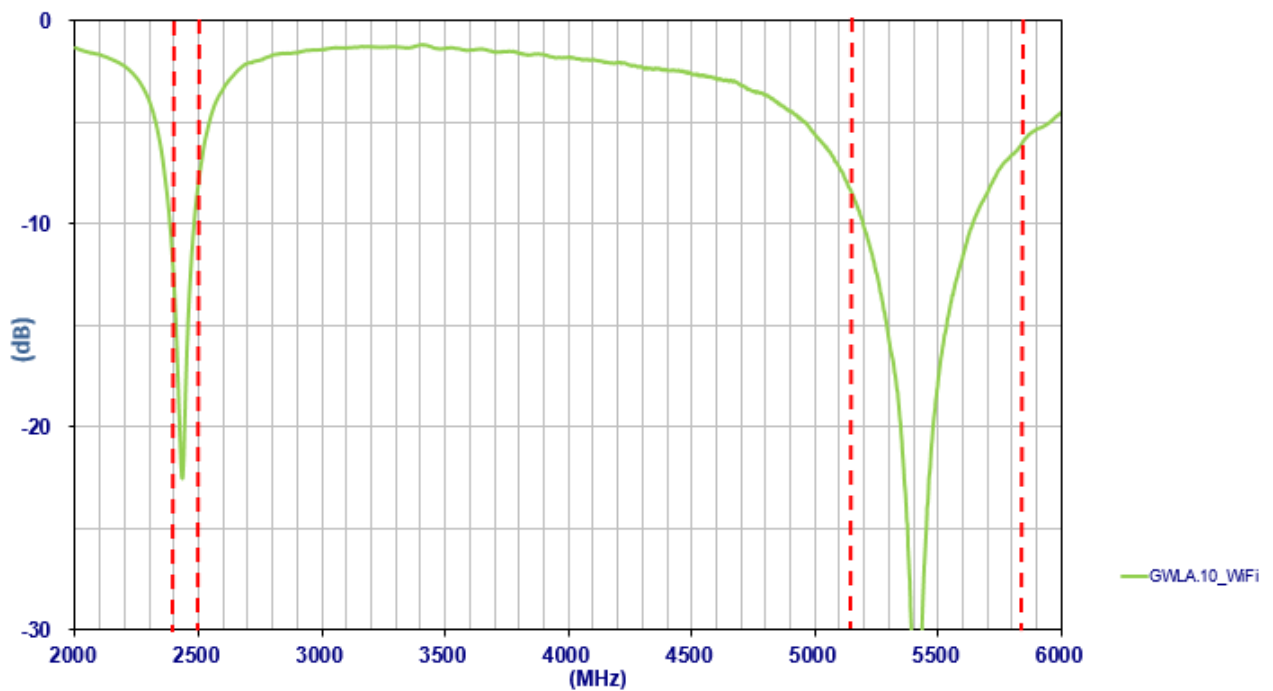

3.5 Efficiency- Wi-Fi Dual-Band

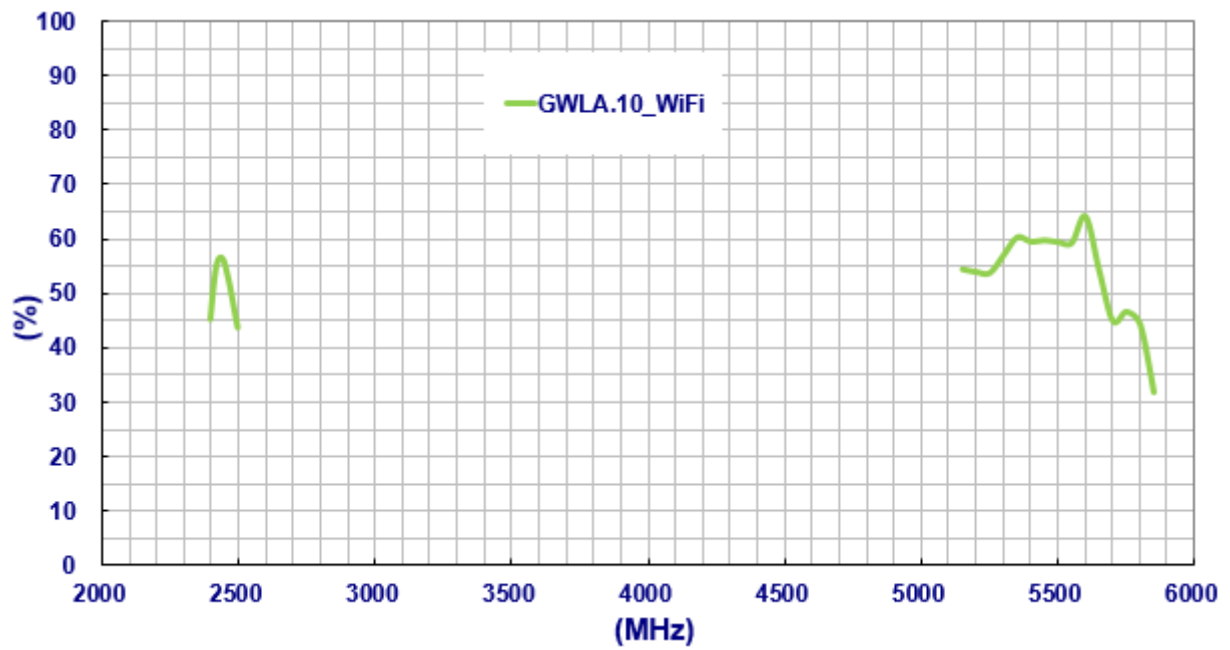

3.6 Peak Gain

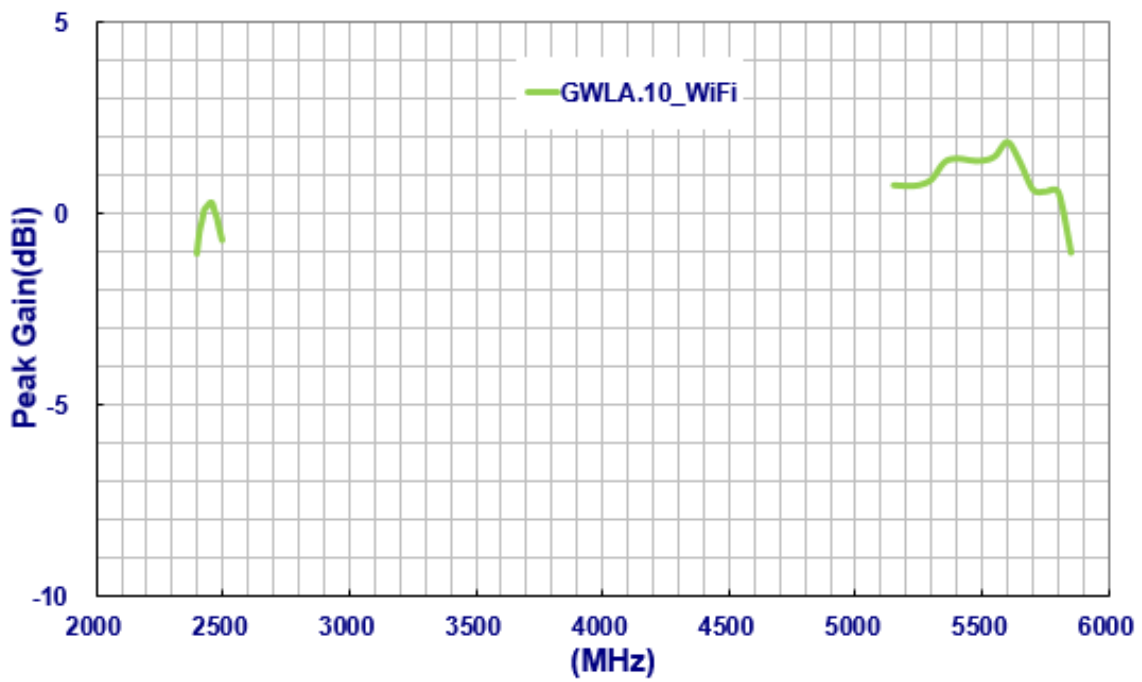

3.7 Isolation

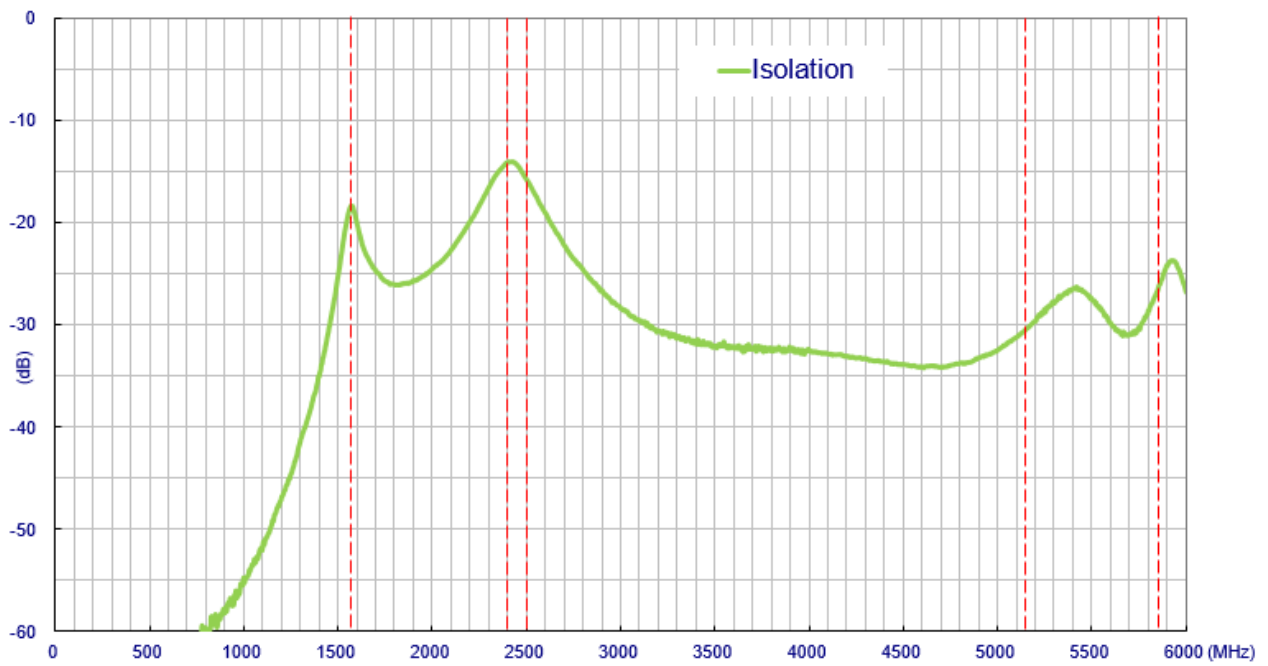

4. 2D Radiation Patterns

4.1 Test Setup

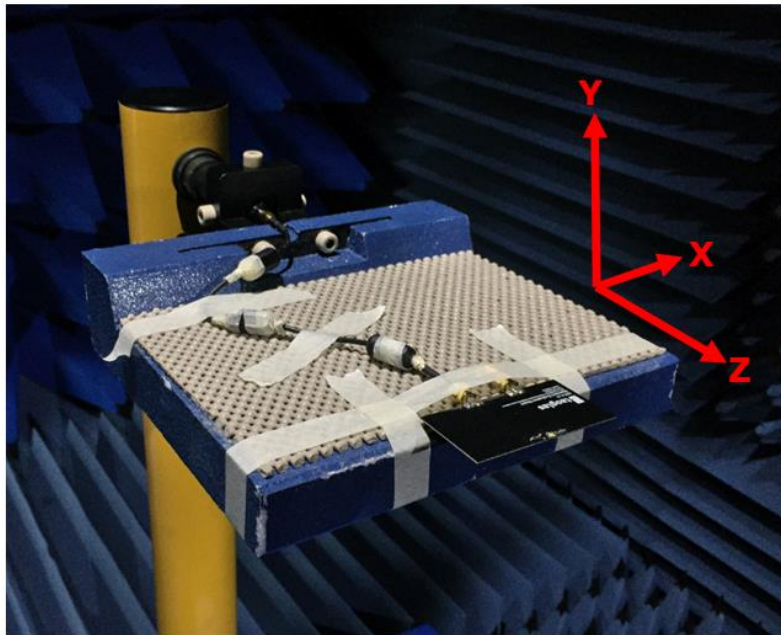

4.2 2D Gain Pattern@ GPS/GALILEO 1575.42MHz

XY Plane

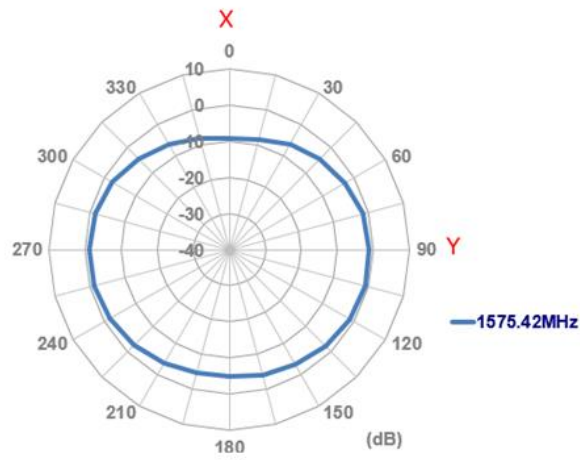

XZ Plane

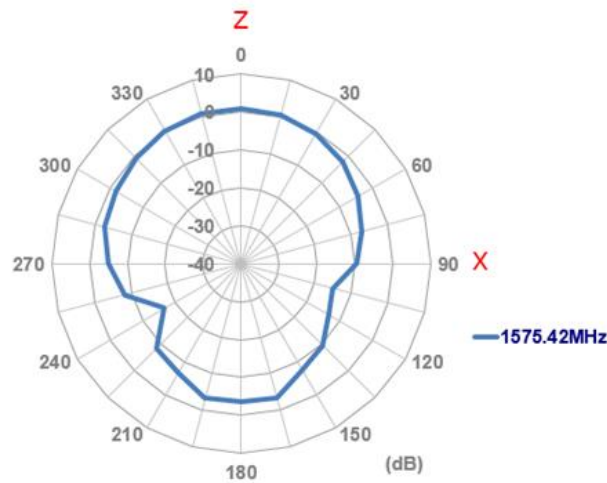

YZ Plane

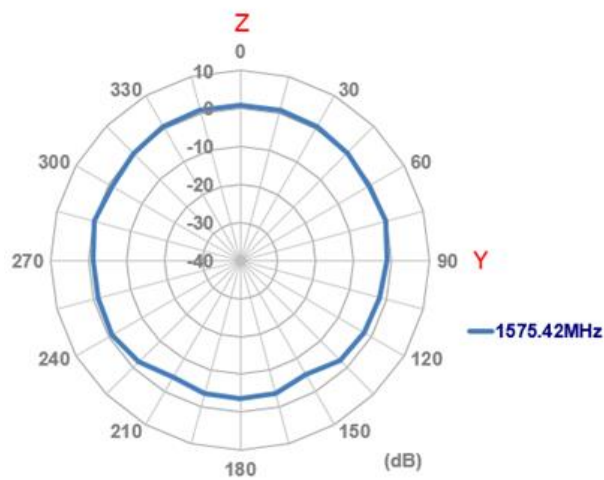

4.3 2D Gain Pattern@ GPS/GALILEO 1575.42MHz

XY Plane

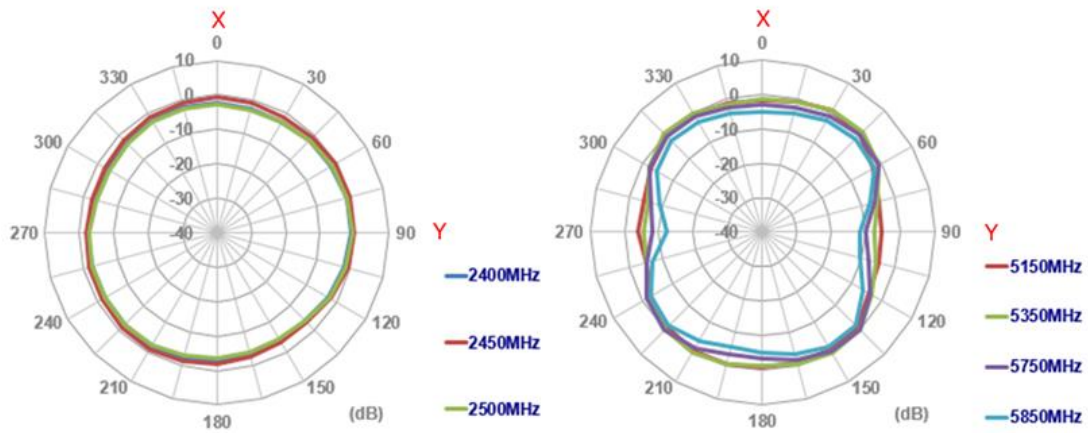

XZ Plane

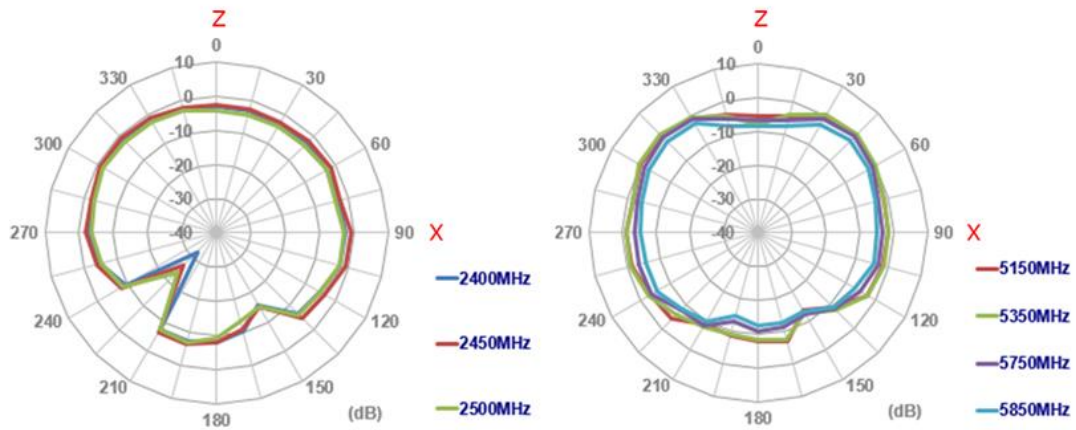

YZ Plane

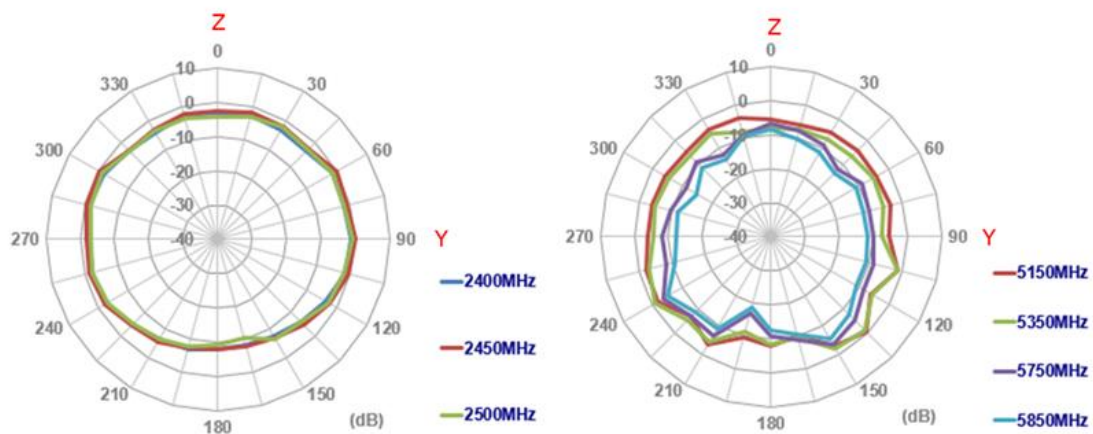

5. 3D Radiation Patterns

5.1 Gain Pattern@ GPS/GALILEO 1575.42MHz

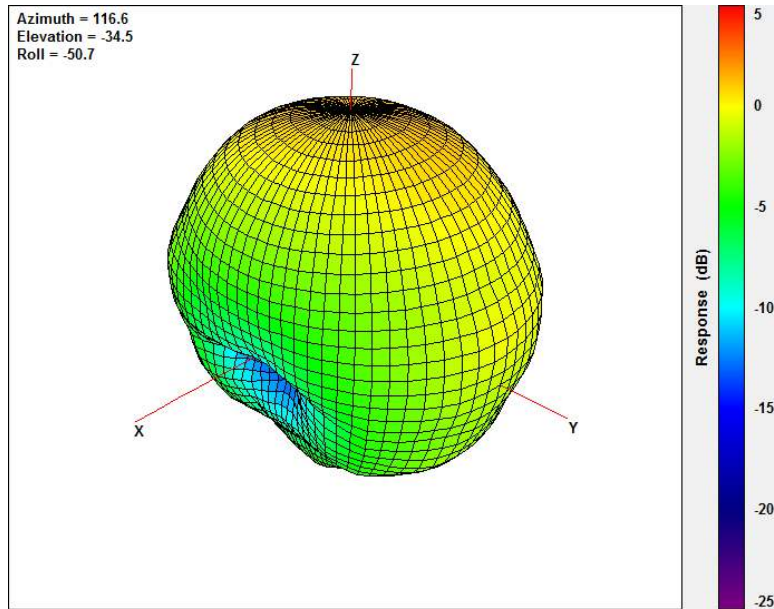

5.2 Gain Pattern@ Wi-Fi Dual Bands

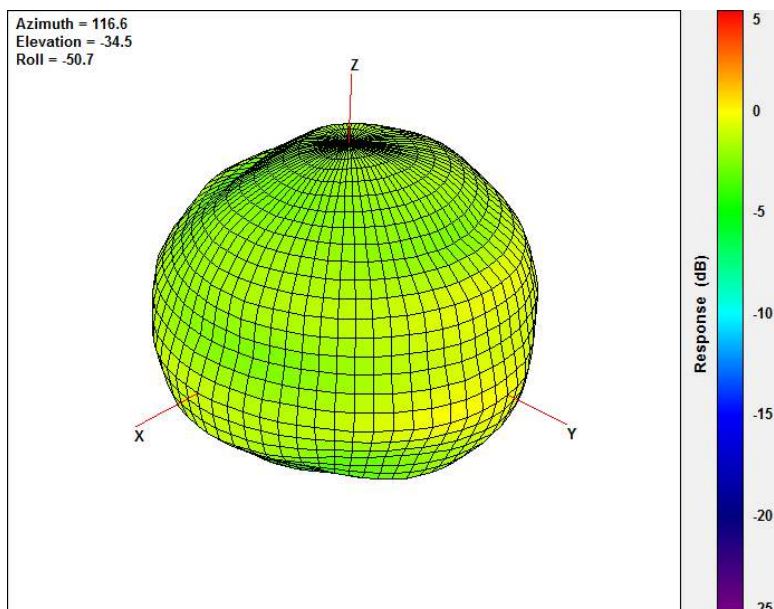

6. Mechanical Drawing (Units: mm)

6		5		4		3		2		1	
ISO NO: EDW-18-8-1129		<Release>		REV	ZONE	DESCRIPTION		ENG	APPROVED	ISSUED DATE	
				△	ALL	Initial Design		Eva	Paul	2018/10/12	
G	<p>Front View</p>		<p>Side View</p>		<p>Back View</p>						
	SCALE: 1/1										
Foot Print											
F	<p>Top Copper</p> <p>Pad 1 and 11 should be connected to a 50 ohm transmission line. Pad 5 and 15 are connected to GND.</p>			<p>Top Solder Paste</p> <p>Pads 1 and 3 are the same size, Pads 5, 14, 15 are the same size. Pads 4, 6, 7, 8, 9, 10, 11, 12, 13 are the same size.</p>			<p>Top Solder Mask</p> <p>Pads 1 and 3 are the same size, Pads 5, 14, 15 are the same size. Pads 4, 6, 7, 8, 9, 10, 11, 12, 13 are the same size. This drawing is a negative of solder mask. Black regions are anti-mask.</p>				
	<p>GPS Feed Connected to 50 ohm transmission line.</p> <p>WiFi Feed Connected to 50 ohm transmission line.</p> <p>Connected to GND</p>										
E	<p>Bottom Copper(Top View)</p>			<p>Bottom Solder Paste</p> <p>N/A</p>			<p>Bottom Solder Mask</p>				
	<p>Connected to GND</p>										
D	<p>Top Composite</p>			<p>Bottom Composite(Top View)</p>							
C	<p>NOTE:</p> <p>1. Ag Plated area </p> <p>2. Solder Mask area </p> <p>3. Copper area </p> <p>4. Paste area </p> <p>5. Copper Keypout Area </p>			<p>6. Ground keypout should extend from top layer through all inner PCB layers to minimize coupling from RF feed to ground.</p> <p>7. Any vias in pads should be either filled or tented to prevent solder from wicking away from the pad during reflow.</p> <p>8. The dimension tolerances should follow standard PCB manufacturing guidelines</p>							
B	<p>UNLESS OTHERWISE SPECIFIED</p> <p>TOLERANCES ON:</p> <p>.X± 0.2</p> <p>XX± 0.5 .XX± 0.1</p> <p>X± 0.3 .XXX± 0.05</p>			<p>DATE: 2016/03/10</p> <p>UNIT: mm</p> <p>THIRD ANGLE PROJECTION</p>		<p>MAT'L:</p> <p>FINISH:</p> <p>SCALE: 2/1</p>				<p>REV</p> <p>A</p>	
	<p>APPROVED BY: Wayne</p> <p>CHECKED BY: Paul</p> <p>DRAWN BY: Haley</p>			<p>CUSTOMERS SIGNATURE / DATE</p>		<p>TITLE: : GPS & 2.4/5GHz Dual-Band Ceramic Substrate Loop Antenna/3.2*1.6*0.5(mm)/Linear Polarized</p> <p>PART NO. : GWLA.10</p>					
6		5		4		3		2		1	

7. Antenna Integration Guide

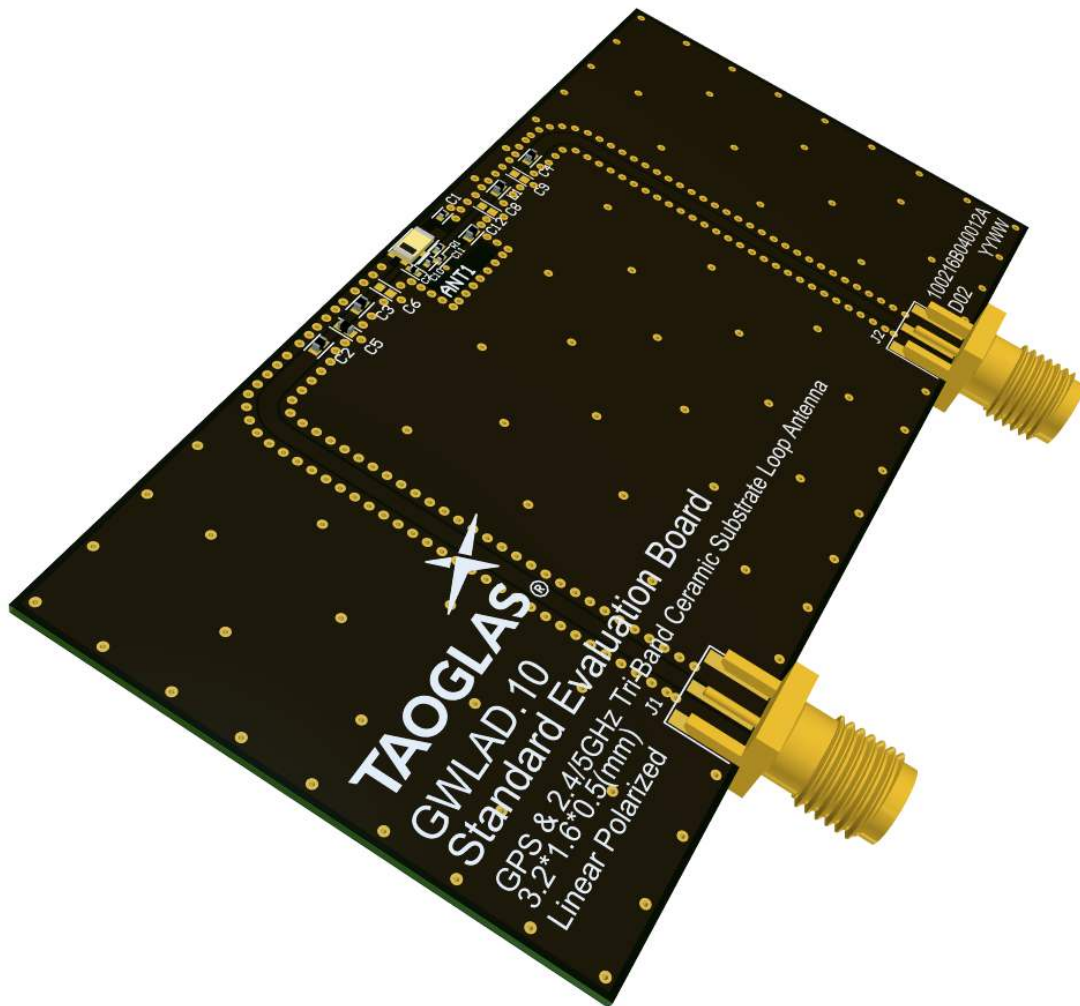
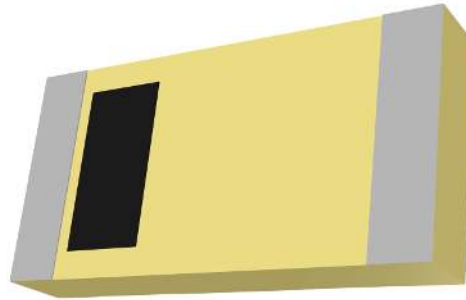

7.1 Schematic Symbol and Pin Definition

The circuit symbol for the antenna is shown below. The antenna has 5 pins with all five pins as functional.

Pin	Description
1	GPS Feed
2, 4	Ground
3	Wi-Fi Feed
5	FTE

GWLA.10
ANT1

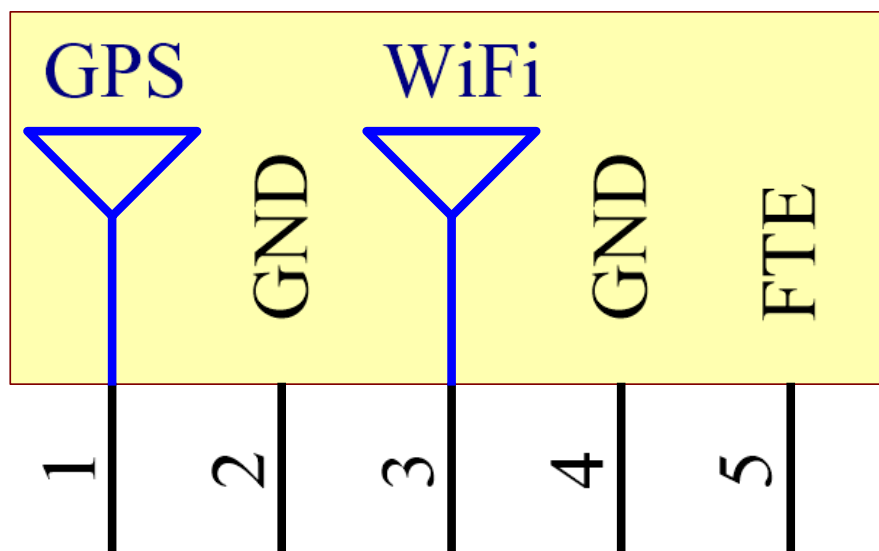

7.2 Antenna Integration

For any given PCB size, the antenna should ideally be placed on the PCB's longest side, to take advantage of the ground plane. Optimized matching components can be placed as shown.

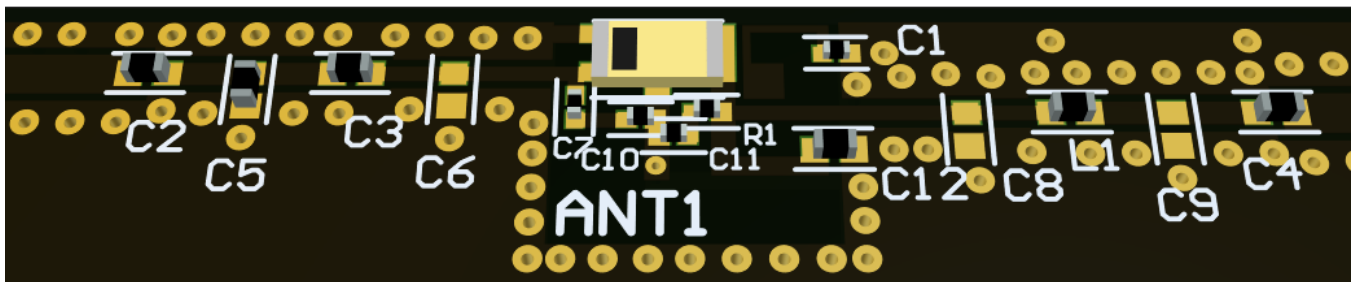

Top Side w/ Solder Mask

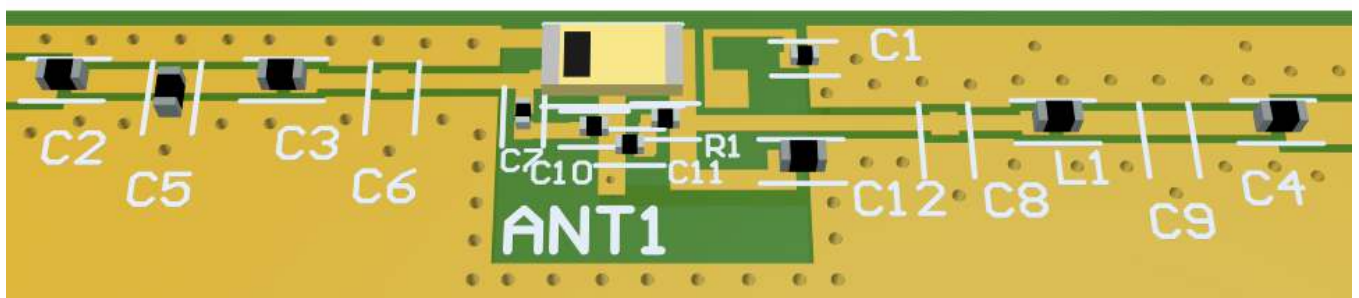

Top Side w/o Solder Mask

7.3 PCB Layout

The footprint and clearance on the PCB must meet the layout drawing in (Footprint Drawing). Note the placement of the optimized components. C3 & C7 are placed as close as possible to the GPS feed (pad 1) but still within the transmission line. C5 is then placed tightly in parallel after that followed by C2 in series. L1, R1 & C12 are placed as close as possible to the Wi-Fi feed (pad 3) but still within the transmission line. C10 & C11 are placed tightly to ground feed (pad 2). C4 is then placed tightly in series after that. C6, C8, & C9 are optional components but the footprints are recommended in case they are needed.

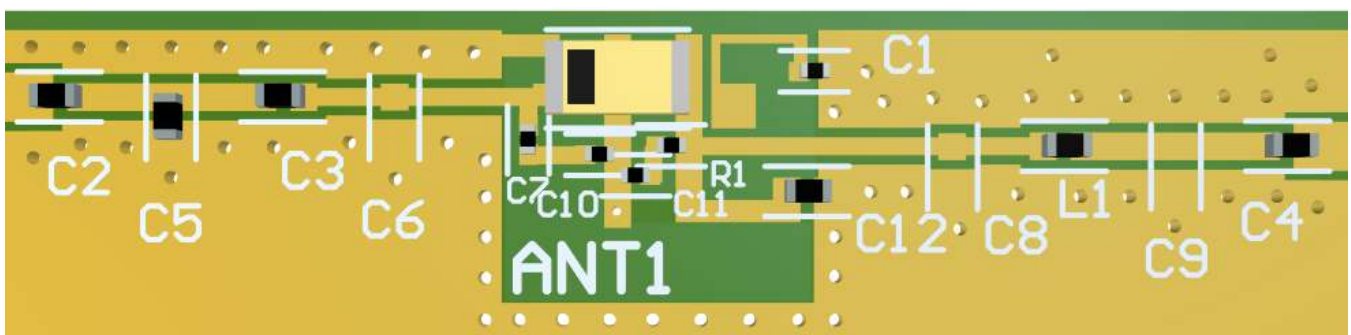

Topside

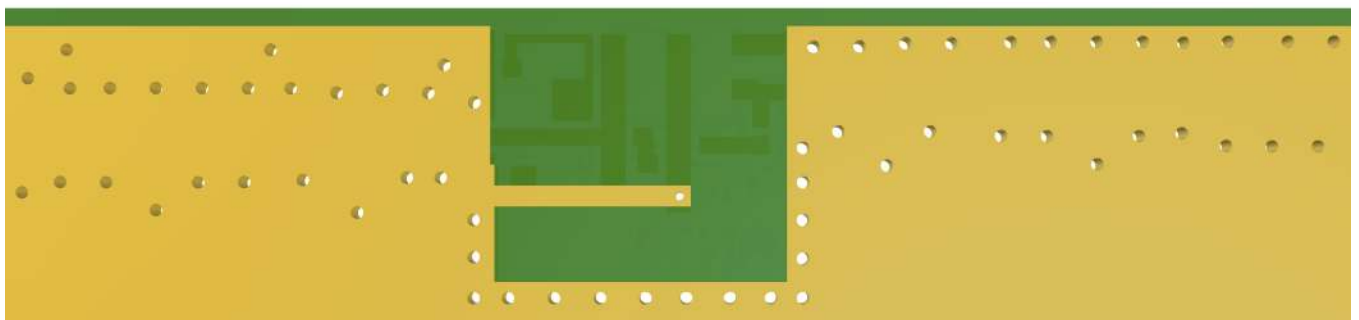

Bottom Side

7.4 PCB Clearance

Below shows the antenna footprint and clearance through ALL layers on the PCB. Only the antenna pads and connections to feed and GND are present within this clearance area (marked RED). The clearance area extends to 6.3mm in length and 7.6mm in width from the top center of the PCB. This clearance area includes the bottom side and ALL internal layers on the PCB.

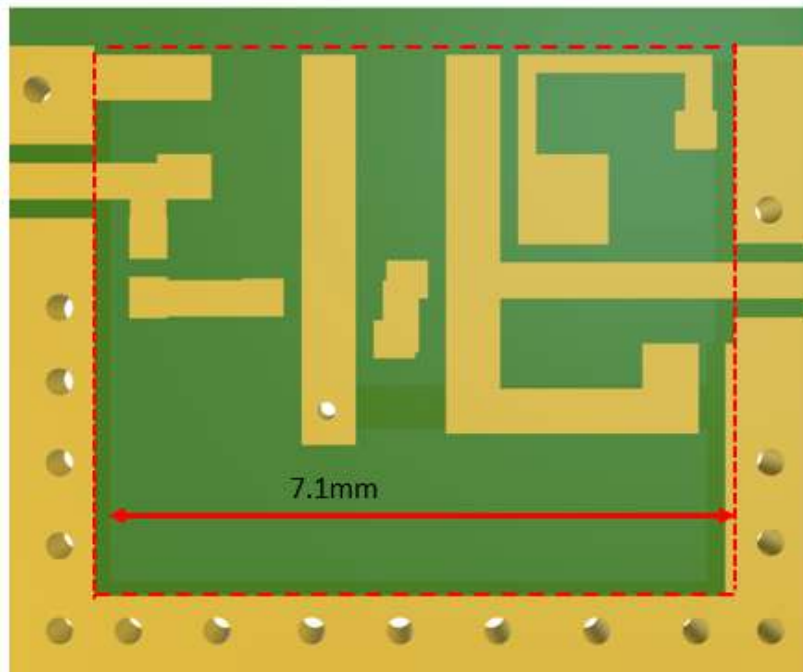

Topside

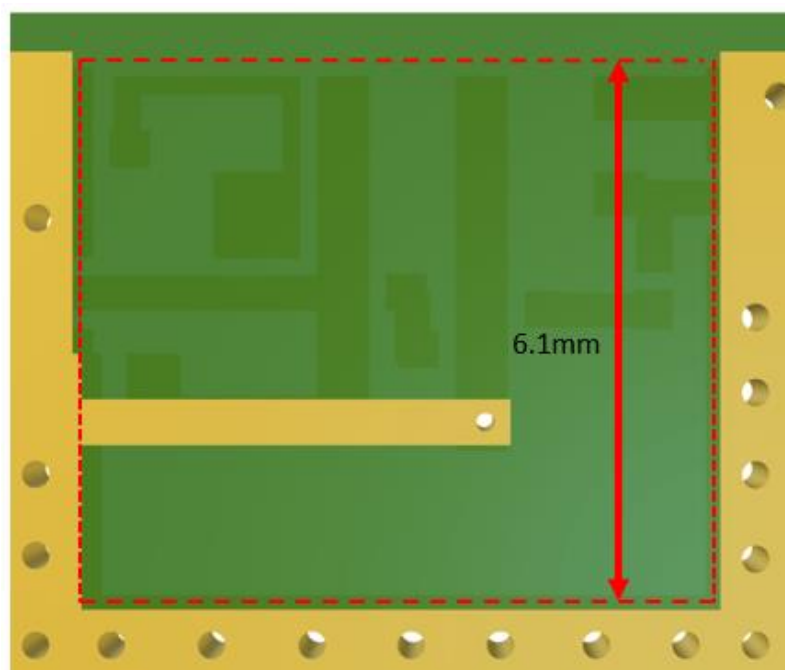

Bottom Side

7.5 Evaluation Board



Topside

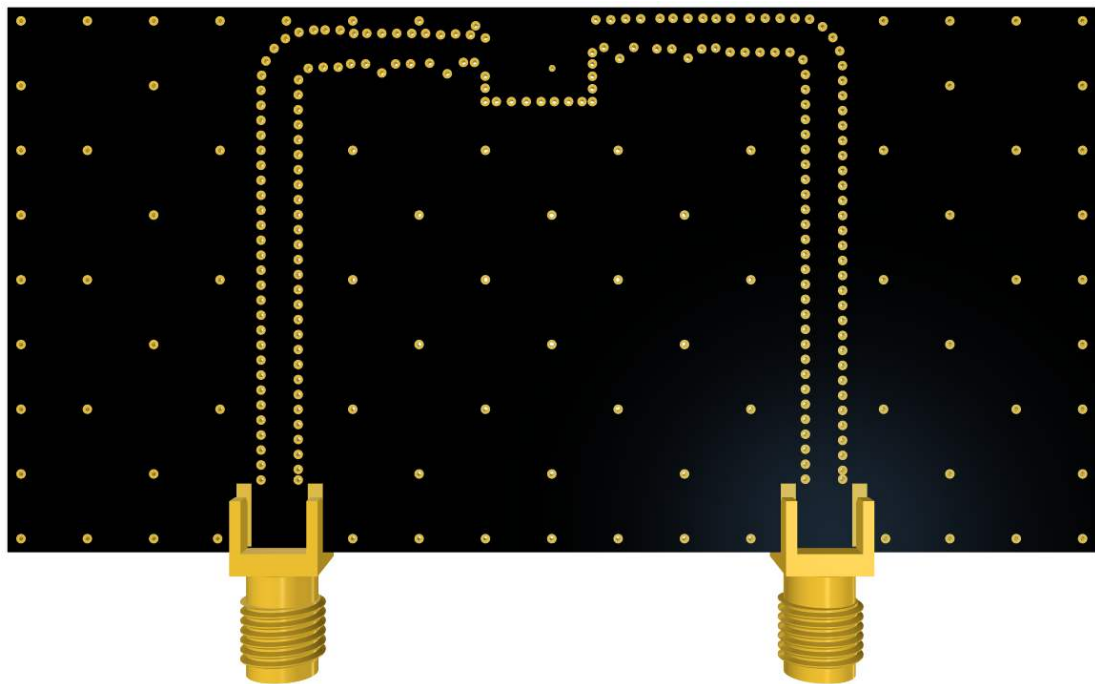

Bottom Side

7.6 Evaluation Board Matching Circuit

Matching components for the GWLA.10 are required for the antenna to have optimal performance on the evaluation board, located outside of the copper clearance in the space specified in the above images. Additional matching components may be necessary for your device, so we recommend incorporating extra component footprints, forming a “pi” network, between the radio module and the antenna.

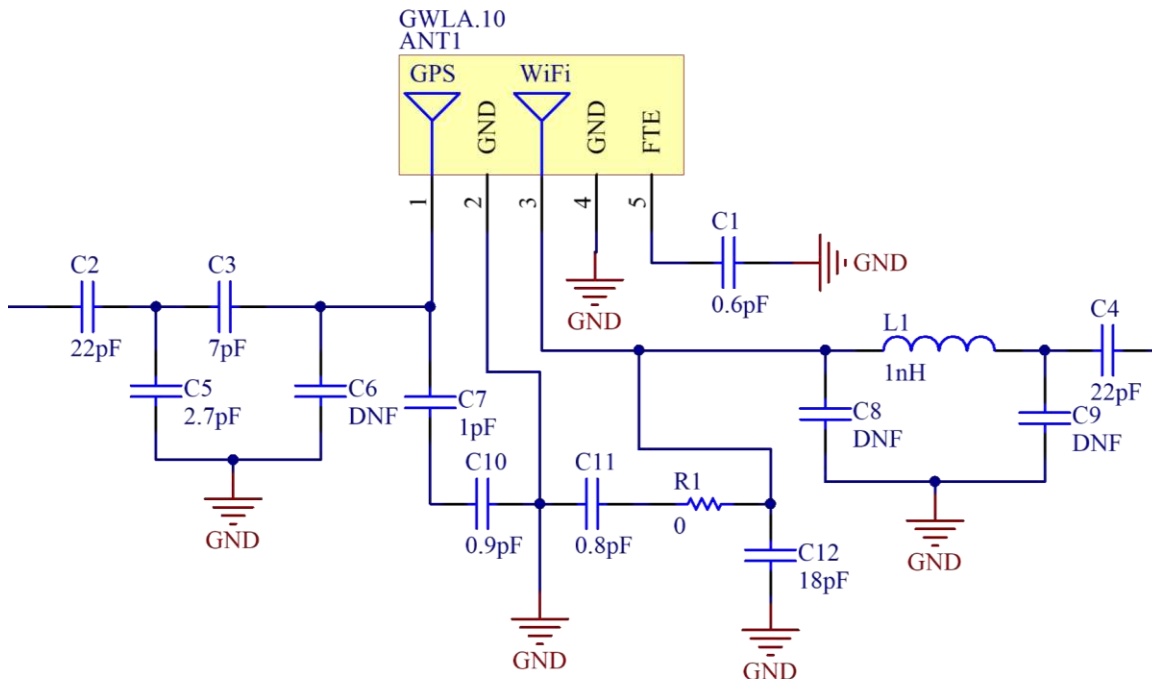

Designator	Type	Value	Manufacturer	Manufacturer Part Number
L1	Inductor	1nH	TDK	MLK1005S1N0ST000
R1	Resistor	0 Ohms	Panasonic	ERJ-1GN0R00C
C1	Capacitor	0.6pF	Murata	GRM0335C1HR60BA01D
C2	Capacitor	22pF	Murata	GRM1555C1H220JA01D
C3	Capacitor	7pF	Murata	GRM1555D1H7R0DA01D
C4	Capacitor	22pF	Murata	GRM1555C1H220JA01D
C5	Capacitor	2.7pF	Murata	GRM1555C1H2R7CA01D
C6	Capacitor	DNF	-	-
C7	Capacitor	1pF	Murata	GRM0335C1H1R0CA01D
C8	Capacitor	DNF	-	-
C9	Capacitor	DNF	-	-
C10	Capacitor	0.9pF	Murata	GRM0335C1HR90BA01D
C11	Capacitor	0.8pF	Murata	GRM0335C1HR80BA01D
C12	Capacitor	18pF	Murata	GRM1555C1H180JA01D

8. Mechanical Drawing – Evaluation Board

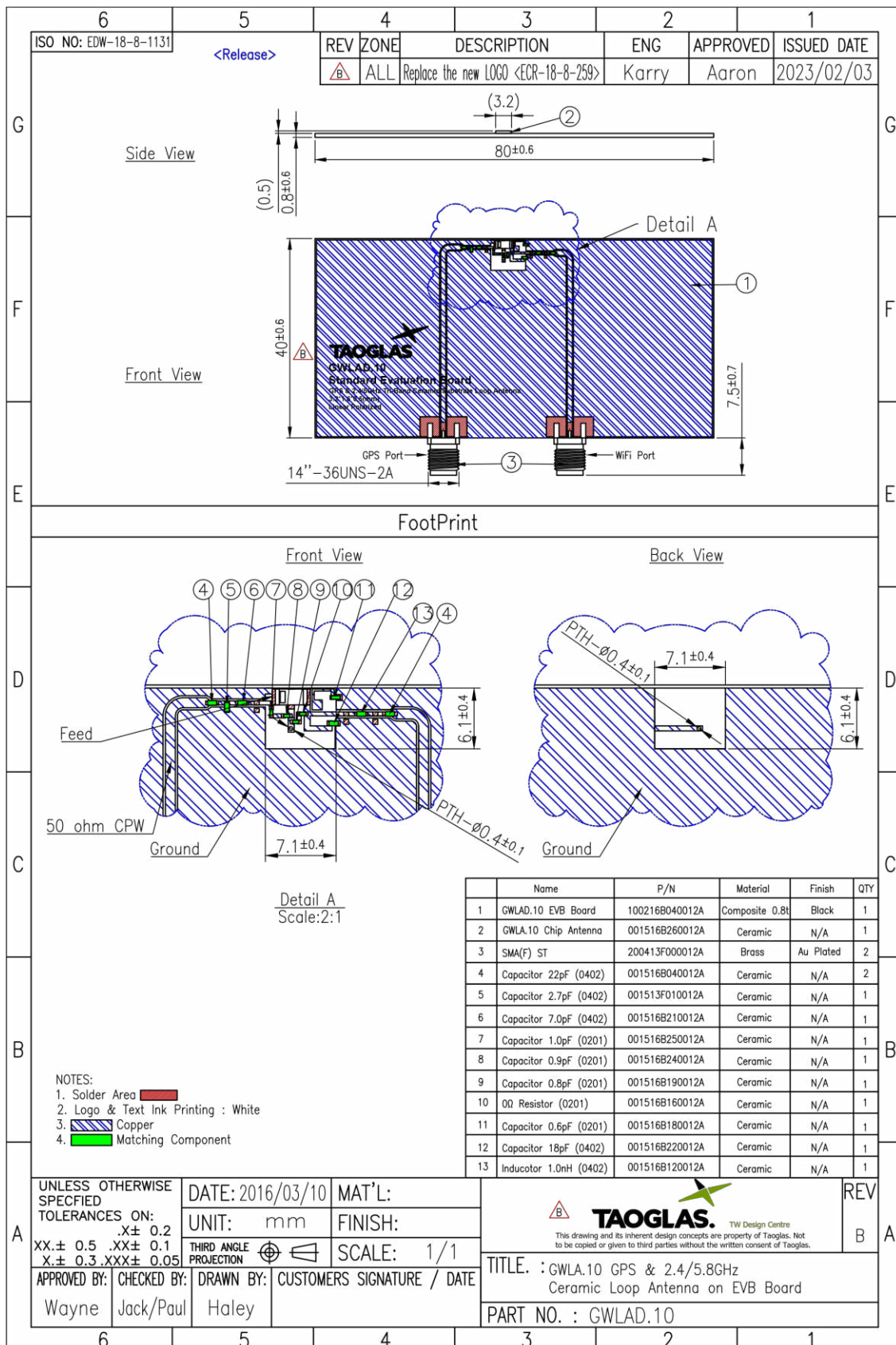

9. Matching Circuit

Like all antennas, surrounding components, enclosures, and changes to the GND plane dimensions can alter performance. A pi-matching network like the one shown below is required in case adjustments need to be made. The antenna EVB has a similar matching network. The components on the EVB are a good starting point for a new design, but will need to be adjusted upon integration for best performance. The zero ohm resistor is needed to solder down a coax pigtail to make measurements with a vector network analyzer.

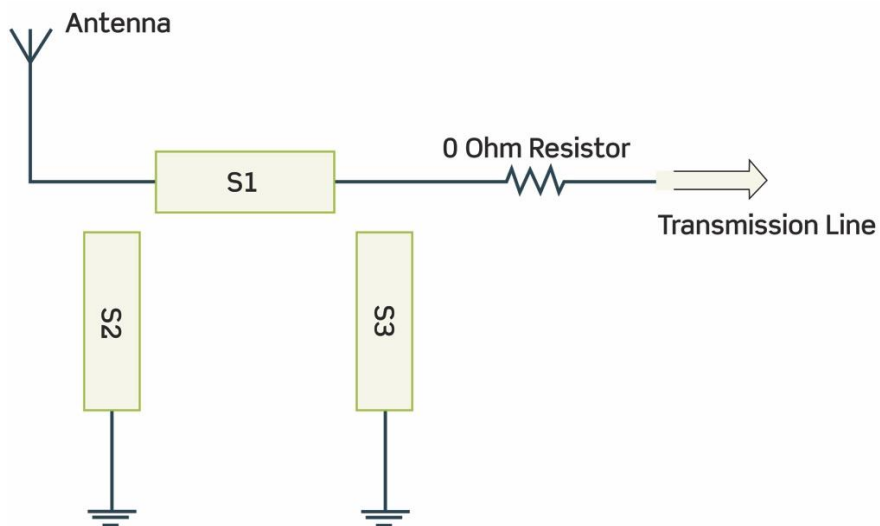

10. Soldering Conditions

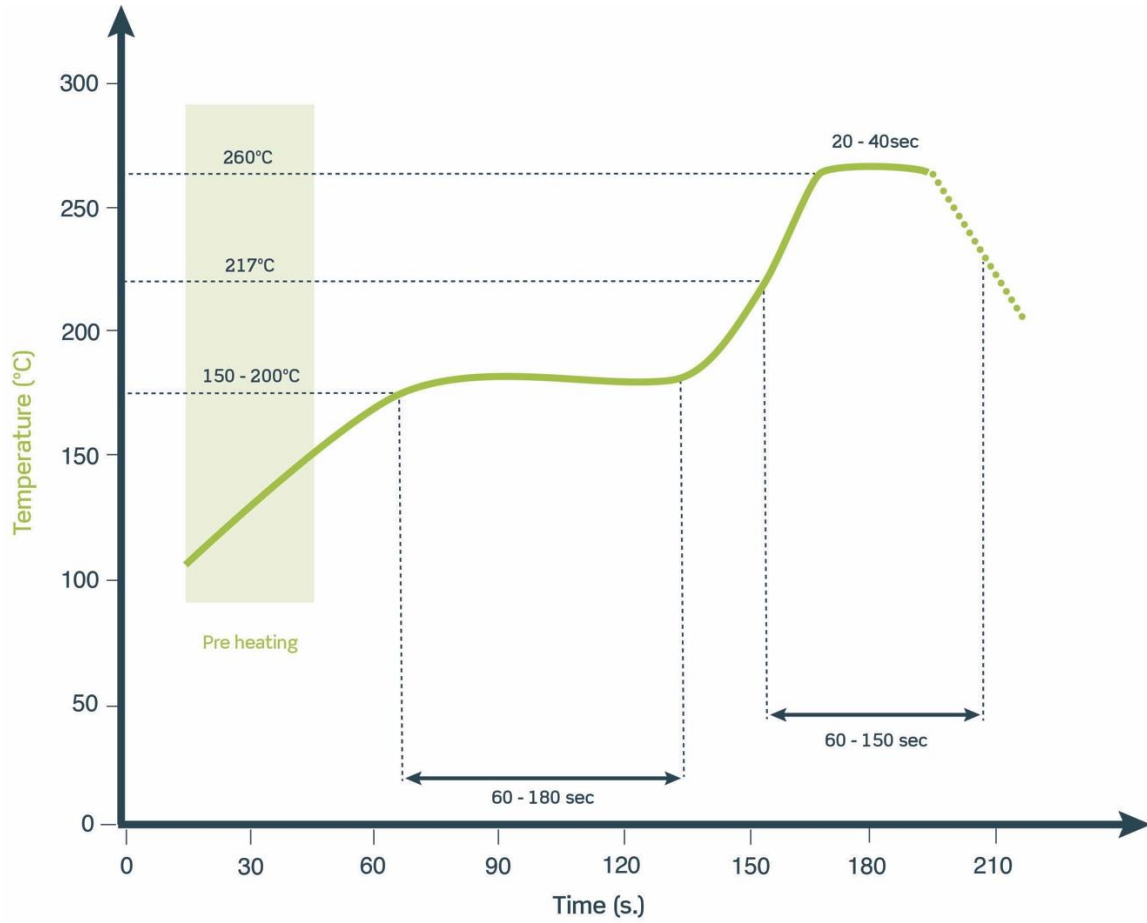

11. Packaging

5000 pcs GWLA.10 per tape & reel
 Dimensions - 330*330*17mm
 Weight - 484g

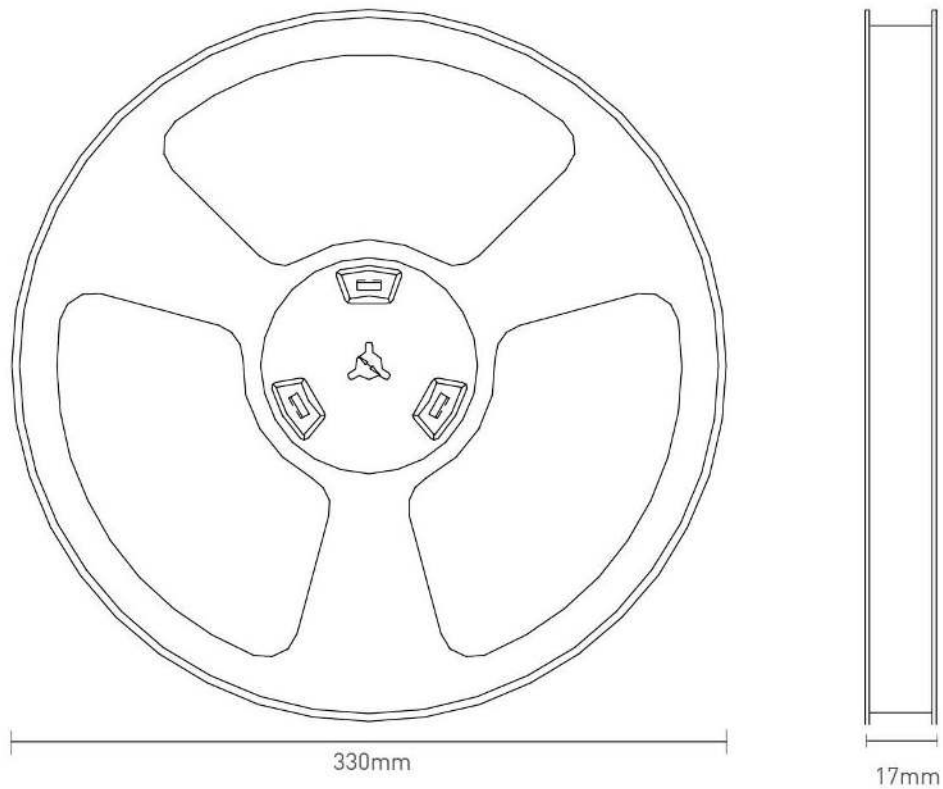

Tape Dimensions (unit: mm)		
Feature	Spec	Tolerances
W	12.00	±0.30
P	4.00	±0.10
E	1.75	±0.10
F	5.50	±0.10
P2	2.00	±0.10
D	1.50	+0.10 -0.00
Po	4.00	±0.10
10Po	40.00	±0.10

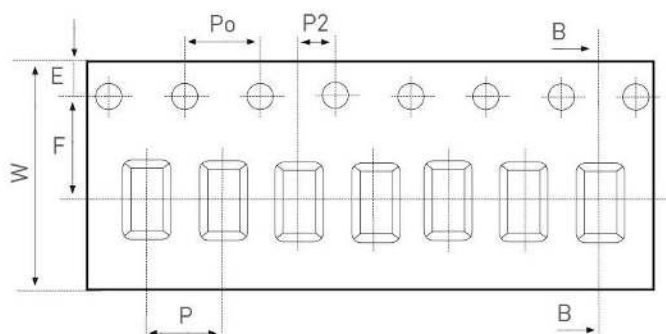

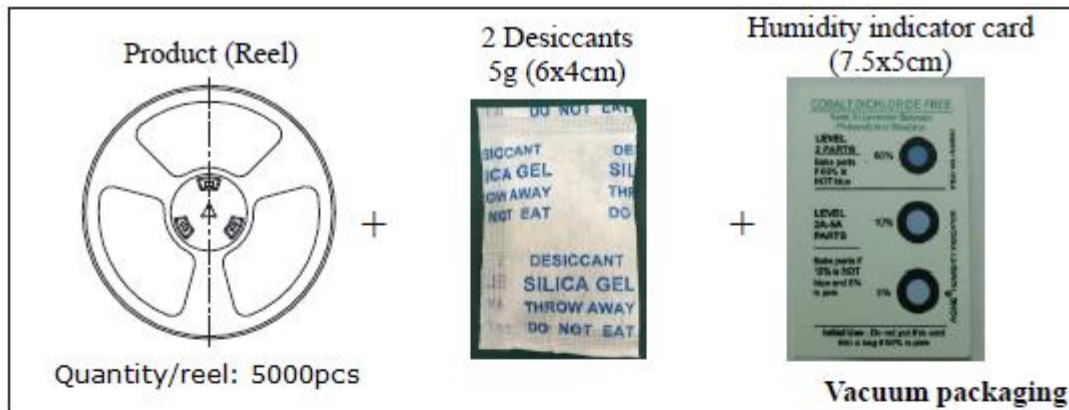

5000 pcs GWLA.01
1 reel in small inner box
Dimensions - 330*330*17
Weight - 484g

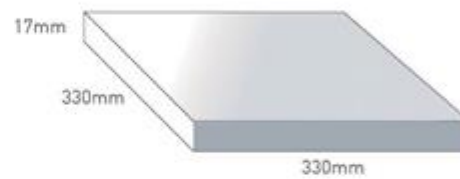

9 boxes / 45000 pcs in one carton
Carton Dimensions - 350*350*210mm
Weight - 4.89Kg

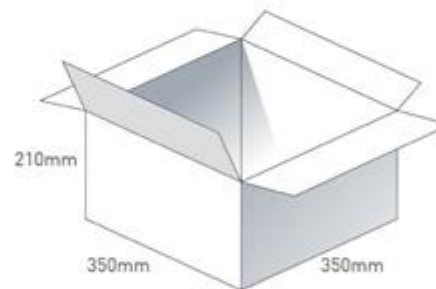

Pallet Dimensions 1220*1020*1410mm
36 Cartons per Pallet
4 Cartons per layer
9 Layers

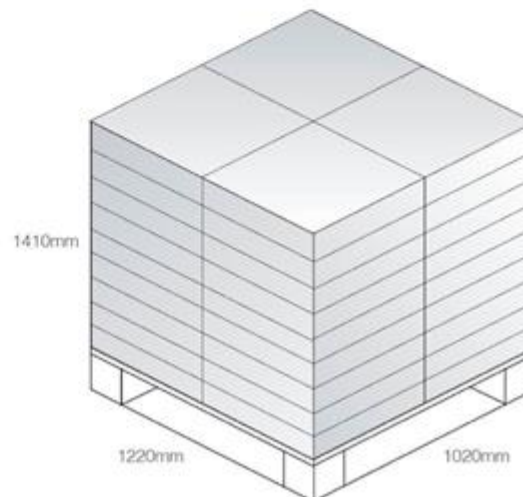

Changelog for the datasheet

SPE-16-08-049– GWLA.10

Revision: E (Current Version)

Date:	2023-03-10
Changes:	Added Antenna Integration Guide
Changes Made by:	Cesar Sousa

Previous Revisions

Revision: D

Date:	2022-06-17
Changes:	Updated Specifications
Changes Made by:	Cesar Sousa

Revision: C

Date:	2021-10-21
Changes:	Updated Specifications
Changes Made by:	Erik Land

Revision: B

Date:	2018-06-17
Changes:	Updated Specifications
Changes Made by:	Jack Conroy

Revision: A (Original First Release)

Date:	2017-05-17
Notes:	Initial Specification Release
Author:	Author



TAOGLAS®

www.taoglas.com

