

# Views from "X" rotated

6-Pole

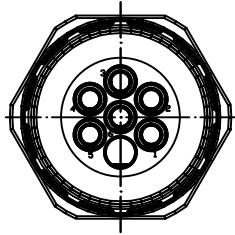

7-Pole

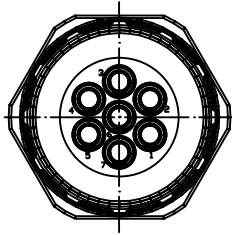

9-Pole  
(8+1)

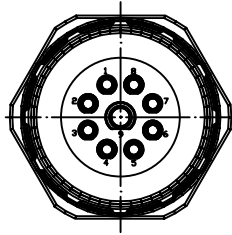

12-Pole

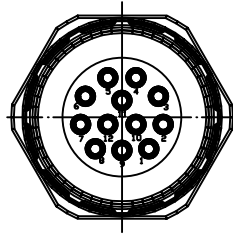

16-Pole

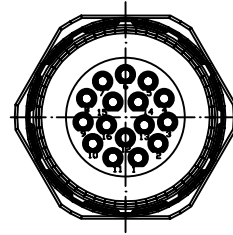

17-Pole

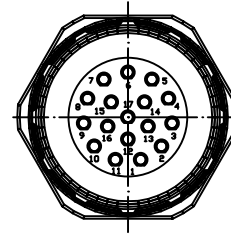

19-Pole  
(16+3)

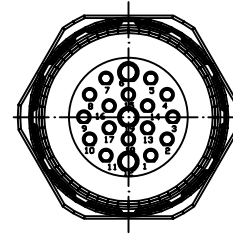

Cable Diameter	Solder Contacts	PCB Contacts	Crimp Contacts	Without Contacts
6 Pole	KRS6P46-550	KRS6P46-770	KRS6P46-400	KRS6P46-000
	1202310092	1202310093	1202310094	1202310095
	Crimp range*		0,75-2,5mm <sup>2</sup>	
7 Pole	KRS7P46-550	KRS7P46-770	KRS7P46-400	KRS7P46-000
	1202310096	1202310097	1202310098	1202310099
	Crimp range*		0,75-2,5mm <sup>2</sup>	
9 Pole (8+1)	KRS9P46-550	KRS9P46-770	KRS9P46-410	KRS9P46-000
	1202310100	1202310101	1202310102	1202310103
	Crimp range*		0,14-1,0mm <sup>2</sup> /0,75-2,5mm <sup>2</sup>	
12 Pole	KRSCP46-550	KRSCP46-770	KRSCP46-010	KRSCP46-000
	1202310104	1202310105	1202310106	1202310107
	Crimp range*		0,14-1,0mm <sup>2</sup>	
16 Pole	KRSHP46-550	KRSHP46-770	KRSHP46-010	KRSHP46-000
	1202310108	1202310109	1202310110	1202310111
	Crimp range*		0,14-1,0mm <sup>2</sup>	
17 Pole	KRSJP46-550	KRSJP46-770	KRSJP46-010	KRSJP46-000
	1202310112	1202310113	1202310114	1202310115
	Crimp range*		0,14-1,0mm <sup>2</sup>	
19 Pole (16+3)	KRSLP46-550	KRSLP46-770	KRSLP46-110	KRSLP46-000
	1202310116	1202310117	1202310118	1202310119
	Crimp range*		0,14-1,0mm <sup>2</sup> /0,14-1,0mm <sup>2</sup>	

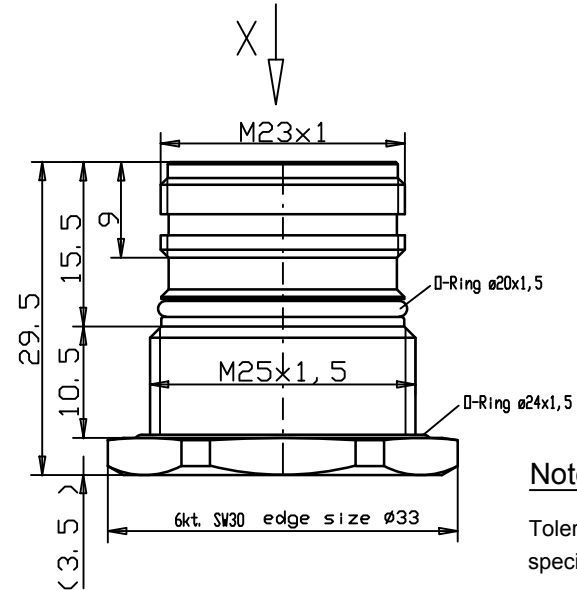
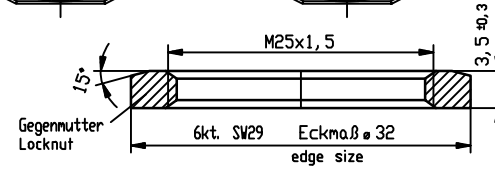

**Notes:**

Tolerances (unless specified): DIN ISO 2768m

\*Crimp range only applies to "Crimp Contacts" version

DESCRIPTION EC NO: IPG2013-1569 DRWN: BBR/BLAUCH CHKD: REISSNER APPR: REISSNER	QUALITY SYMBOLS ▽ = 0 ▽ = 0	GENERAL TOLERANCES (UNLESS SPECIFIED)		DIMENSION STYLE MM		SCALE ---	DESIGN UNITS METRIC	THIRD ANGLE PROJECTION	
		mm	INCH	DRAWN BY BB	DATE 2008/11/17	REC M23 XP XC MA STR M25 BM UNSH BRA			
REV 2	DESCRIPTION	DRAFT WHERE APPLICABLE MUST REMAIN WITHIN DIMENSIONS		MATERIAL NO.		DOCUMENT NO.		SHEET NO.	
		SIZE A3		THIS DRAWING CONTAINS INFORMATION THAT IS PROPRIETARY TO MOLEX INCORPORATED AND SHOULD NOT BE USED WITHOUT WRITTEN PERMISSION		SD-120231-005		1 OF 1	

**molex**