

178289-5 ✓ ACTIVE

[Dynamic Series](#) | [Dynamic 3000 Series](#)

TE Internal #: 178289-5

Housing, Receptacle, Wire-to-Board, 10 Position, .15 in [3.81 mm]
Centerline, Crimp, 2 Row, Black, Mating Retention, Wire & Cable,
Dynamic 3000 Series

[View on TE.com >](#)



[Connectors](#) > [PCB Connectors](#) > [Wire-to-Board Connectors](#) > [Wire-to-Board Connector Assemblies & Housings](#) >

Receptacle and Tab Housing: 3.81 mm pitch, 250V



Connector Product Type: **Housing**

Connector & Housing Type: **Receptacle**

Connector System: **Wire-to-Board**

Number of Positions: **10**

Centerline (Pitch): **3.81 mm [.15 in]**

[All Receptacle and Tab Housing: 3.81 mm pitch, 250V \(45\)](#)

Features

Product Type Features

Connector Product Type	Housing
Connector & Housing Type	Receptacle
Connector System	Wire-to-Board
Sealable	No
Connector & Contact Terminates To	Wire & Cable

Configuration Features

Number of Positions	10
Number of Rows	2

Body Features

Primary Product Color	Black
-----------------------	-------

Termination Features

--	--



Termination Method to Wire & Cable	Crimp
------------------------------------	-------

Mechanical Attachment

Mating Retention	With
Connector Mounting Type	Cable Mount (Free-Hanging)

Housing Features

Centerline (Pitch)	3.81 mm[.15 in]
--------------------	-----------------

Dimensions

Row-to-Row Spacing	5.08 mm[.2 in]
--------------------	----------------

Usage Conditions

Operating Temperature Range	-55 – 105 °C[-67 – 221 °F]
-----------------------------	----------------------------

Operation/Application

Circuit Application	Power & Signal
---------------------	----------------

Product Compliance

[For compliance documentation, visit the product page on TE.com>](#)

EU RoHS Directive 2011/65/EU	Compliant
EU ELV Directive 2000/53/EC	Compliant
China RoHS 2 Directive MIIT Order No 32, 2016	No Restricted Materials Above Threshold
EU REACH Regulation (EC) No. 1907/2006	Current ECHA Candidate List: JUNE 2023 (235) Candidate List Declared Against: JAN 2023 (233) Does not contain REACH SVHC
Halogen Content	Not Low Halogen - contains Br or Cl > 900 ppm.
Solder Process Capability	Not applicable for solder process capability

Product Compliance Disclaimer

This information is provided based on reasonable inquiry of our suppliers and represents our current actual knowledge based on the information they provided. This information is subject to change. The part numbers that TE has identified as EU RoHS compliant have a maximum concentration of 0.1% by weight in homogenous materials for lead, hexavalent chromium, mercury, PBB, PBDE, DBP, BBP, DEHP, DIBP, and 0.01% for cadmium, or qualify for an exemption to these limits as defined in the Annexes of Directive 2011/65/EU (RoHS2). Finished electrical and electronic equipment products will be CE marked as required by Directive 2011/65/EU. Components may not be CE marked. Additionally, the part numbers that TE has identified as EU ELV compliant have a maximum concentration of 0.1% by weight in homogenous materials for lead, hexavalent chromium, and mercury, and 0.01% for cadmium, or qualify for an exemption to these limits as defined in the Annexes of Directive 2000/53/EC (ELV). Regarding the REACH Regulation, the information TE provides on SVHC in articles for this part number is based on the latest European Chemicals Agency (ECHA) 'Guidance on requirements for substances in articles' posted at this URL: <https://echa.europa.eu/guidance-documents/guidance-on-reach>

Compatible Parts



TE Part # CAT-D9934-A75
Contact: Component To Wire; 15A, 28-14 wire size



TE Part # CAT-D9934-A75E
Header Assembly: Wire-to-Board, 15A, gold or tin plated

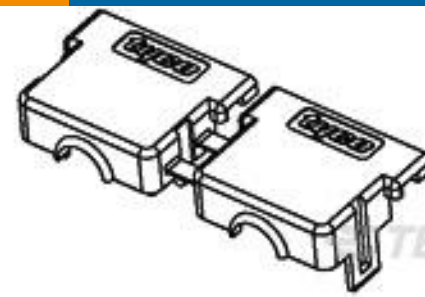

TE Part # 1827149-1
DYNAMIC 3100 CLAMP CABLE 10P

Also in the Series | Dynamic 3000 Series



Connector Contacts(3)



Insertion & Extraction Tools(1)



PCB Connector Keying(1)



PCB Connector Mounting(8)



PCB Headers & Receptacles(283)

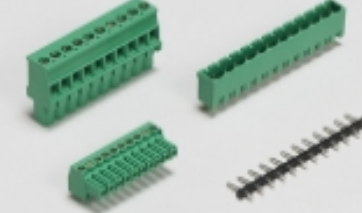

PCB Terminal Blocks(25)



Standard Rectangular Connectors(2)



Wire-to-Board Connector Assemblies & Housings(152)



Wire-to-Board Connector Contacts(91)

Customers Also Bought



Documents

Product Drawings

3.81 DYNAMIC REC HSG 10P D--D

Japanese

CAD Files

Customer View Model

[ENG_CVM_CVM_178289-5_P.2d_dxf.zip](#)

English

3D PDF

3D

Customer View Model

[ENG_CVM_CVM_178289-5_P.3d_igs.zip](#)

English

Customer View Model

[ENG_CVM_CVM_178289-5_P.3d_stp.zip](#)

English

By downloading the CAD file I accept and agree to the [Terms and Conditions](#) of use.

Datasheets & Catalog Pages

[1-1773732-4_DYNAMIC_SERIES_CATALOG_ENGLISH](#)

Japanese

[1-1773732-4_DYNAMIC_SERIES_CATALOG_ENGLISH](#)

English

Product Specifications

Quality Specification

Japanese

Product Environmental Compliance

Product Compliance Document

English

Product Compliance Document

English

Agency Approvals

TUV Certificate

178289-5

Housing, Receptacle, Wire-to-Board, 10 Position, .15 in [3.81 mm] Centerline, Crimp,
2 Row, Black, Mating Retention, Wire & Cable, Dynamic 3000 Series



English