

## Position Control Terminal Block

## XW2B

Simplify Wiring between Motor Controls and Omron's Position Control PLC Modules

- Relays control signals between a servo driver and the PLC position control module or CQM1H PLC with pulse I/O capability
- Connectors are wired with a single screwdriver and no soldering is required
- Dedicated cables connect terminal blocks to position control modules
- Requires 24 VDC for control signal use
- Terminal block organizes wiring and saves space; uses M3 screws
- Mounts to DIN track or with screws for panel mounting

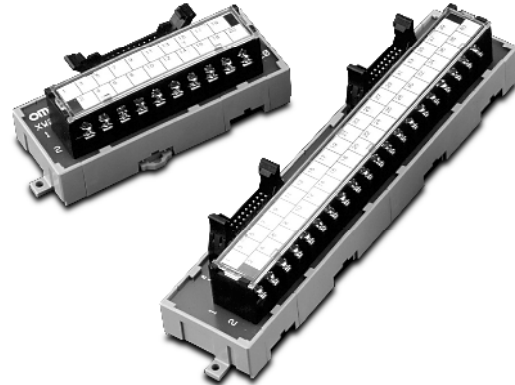

## Ordering Information

### ■ POSITION CONTROL TERMINAL BLOCKS

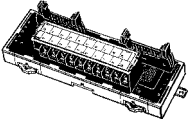
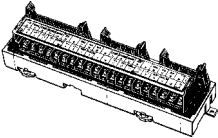
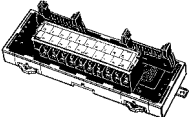
Appearance	Applicable servo driver	Applicable position control module/CQM1H Pulse I/O Board	Part number
	U-series: R88D-UP□□□□ W-series: R88D-WT□□□□	C200H-NC112 C200HW-NC113	<b>XW2B-20J6-1B</b>
		C200H-NC211 C200HW-NC213 C200HW-NC413	<b>XW2B-40J6-2B</b>
		CQM1H-PLB21	<b>XW2B-20J6-3B</b>

### ■ CABLES

#### Cables Between Servo Driver and Terminal Block

Appearance	Position control terminal block	Applicable servo driver	Cable length	Part number
	XW2B-20J6-1B, XW2B-40J6-2B (See Note) XW2B-20J6-3B	R88D-UP□□□□	1 m (3.28 ft)	<b>XW2Z-100J-B1</b>
			2 m (6.56 ft)	<b>XW2Z-200J-B1</b>
		R88D-WT□□□□	1 m (3.28 ft)	<b>XW2Z-100J-B4</b>
			2 m (6.56 ft.)	<b>XW2Z-200J-B4</b>

Note: Two cables will be required on the Servo Driver side if the XW2B-40J6-2B Terminal Block is used for two-axis control.

**Cables Between PLC Position Control Module and Terminal Block**

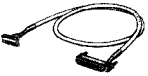
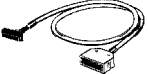
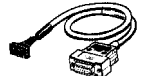
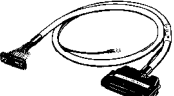
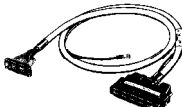
Appearance	Position control terminal block	Applicable position control module	Cable length	Part number
	XW2B-20J6-1B	C200H-NC112 (for one axis)	0.5 m (1.64 ft)	<b>XW2Z-050J-A1</b>
			1 m (3.28 ft)	<b>XW2Z-100J-A1</b>
	XW2B-40J6-2B	C200H-NC211 (for two axes)	0.5 m (1.64 ft)	<b>XW2Z-050J-A2</b>
			1 m (3.28 ft)	<b>XW2Z-100J-A2</b>
	XW2B-20J6-3B (See Note 1)	CQM1H-PLB21 (for one or two axes)	0.5 m (1.64 ft)	<b>XW2Z-050J-A3</b>
			1 m (3.28 ft)	<b>XW2Z-100J-A3</b>
	XW2B-20J6-1B	C200H-NC113 (for one axis)	0.5 m (1.64 ft)	<b>XW2Z-050J-A6</b>
			1 m (3.28 ft)	<b>XW2Z-100J-A6</b>
	XW2B-40J6-2B (See Note 2)	C200HW-NC213 (for two axes) C200HW-NC413 (for four axes)	0.5 m (1.64 ft)	<b>XW2Z-050J-A7</b>
			1 m (3.28 ft)	<b>XW2Z-100J-A7</b>

- Note: 1. Two cables each will be required on the Servo Terminal Block and Position Control Module side, and on the Servo Driver side if the CQM1H-PLB21 is used for two axes.
2. Two cables each will be required on the Servo Terminal Block and Position Control Module side, and on the Servo Driver side if the C200HW-NC413 (four axes) is used for two axes.

# Application Examples



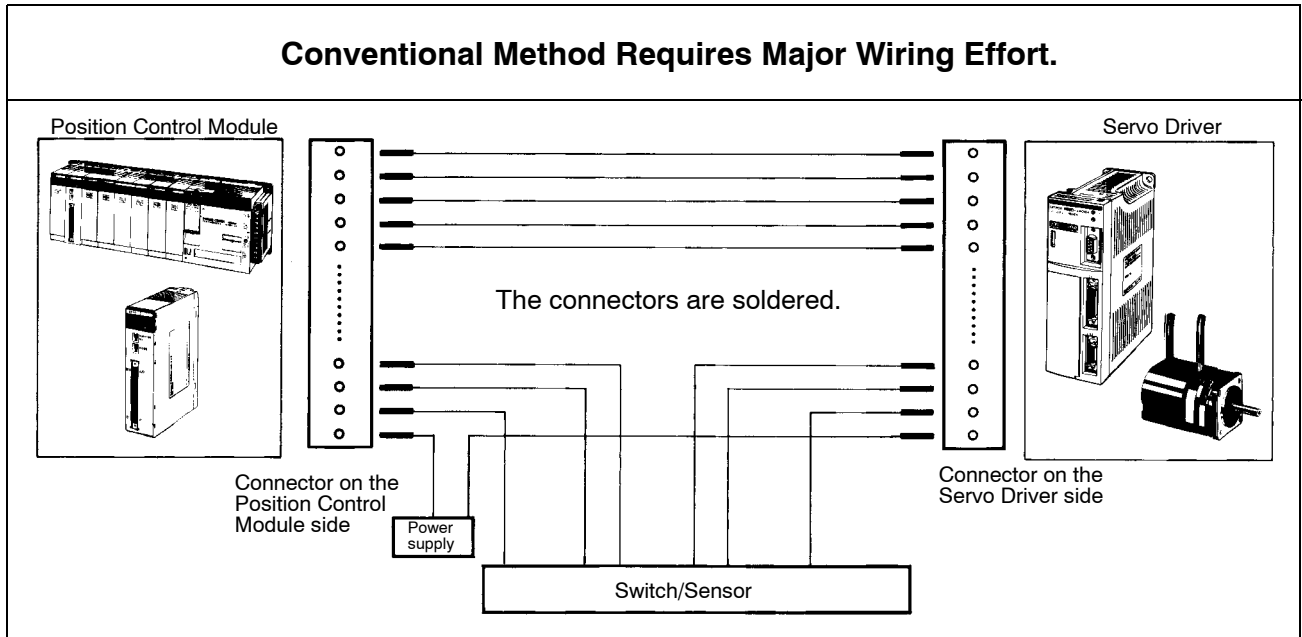



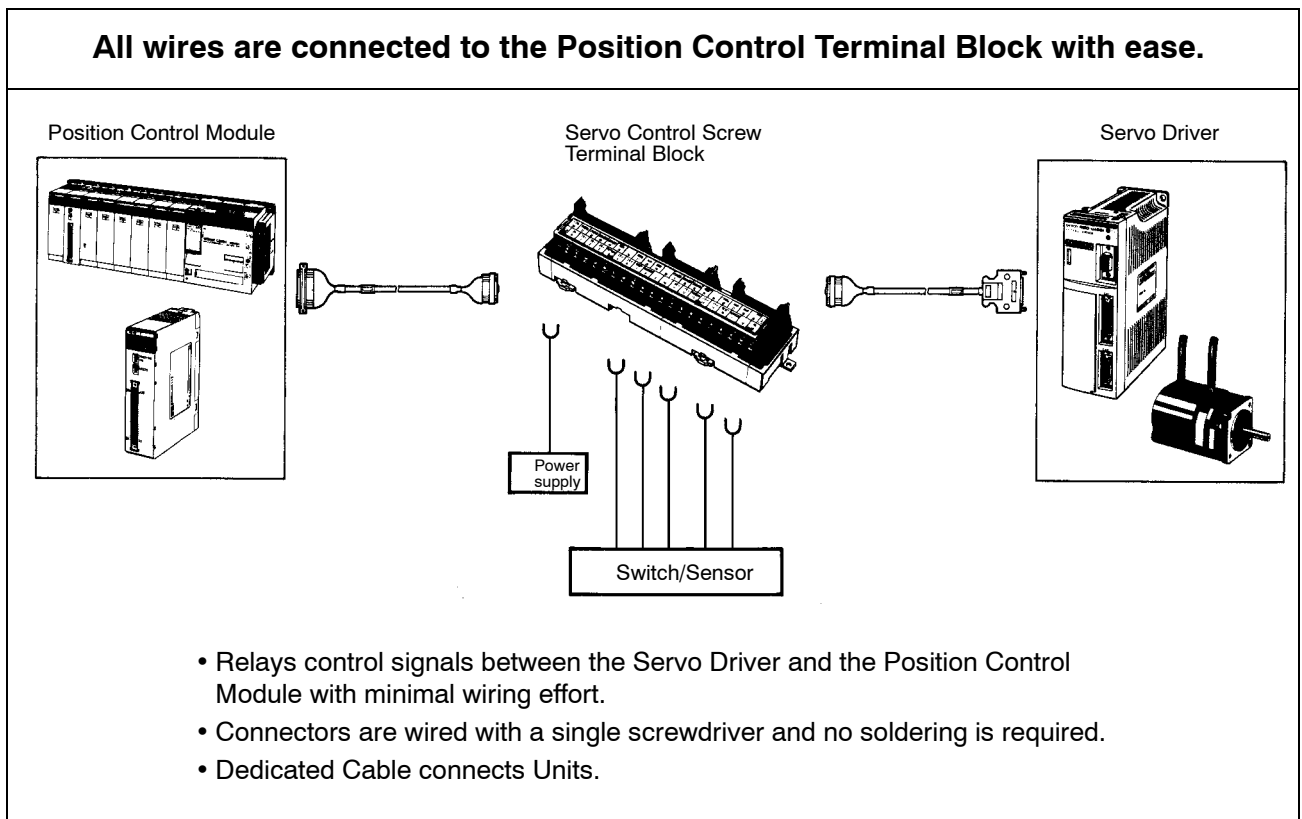





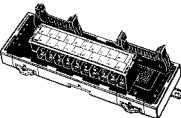
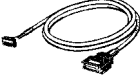

## ■ REDUCE WIRING TO EXTERNAL SENSORS, SWITCHES AND POWER SUPPLY

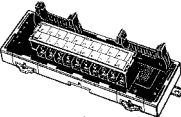

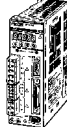
## Position Control Terminal Block

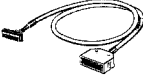
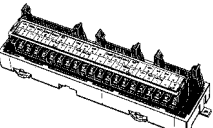

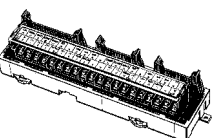
■ TYPICAL CONFIGURATIONS

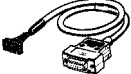
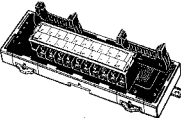
Position Control Module, and CQM1	Cable on the Position Control Module side	Position Control Terminal Block	Cable on the Servo Driver side	Servo Driver
 Position Control Module (for one axis) for C200H C200H-NC112	 Cable for C200H-NC112 XW2Z-□□□J-A1	 Position Control Terminal Block for C200H-NC112 XW2B-20J6-1B (See Note 1)	(See Notes 2, 3 and 4)  U-series Cable XW2Z-□□□J-B1	 U-series Servo Driver R88D-UP□□□
 Position Control Module (for two axis) for C200H C200HW-NC113	 Cable for C200HW-NC113 XW2Z-□□□J-A6	 Position Control Terminal Block for C200HW-NC113 XW2B-20J6-1B (See Note 1)	(See Notes 2, 3 and 4)  W-series Cable XW2Z-□□□J-B4	 W-series Servo Driver R88D-WT□□□
 Position Control Module (for two axis) for C200H C200H-NC211	 Cable for C200H-NC211 XW2Z-□□□J-A2	 Position Control Terminal Block for C200H-NC211 XW2B-40J6-2B (See Note 1)		
 Position Control Module (for two axes/four axes) for C200HW C200HW-NC213 C200HW-NC413	 Cable for C200HW-NC213 (two axes) and C200HW-NC413 (four axes) XW2Z-□□□J-A7	 Position Control Terminal Block for C200HW-NC213 (two axes) and C200HW-NC413 (four axes) XW2B-40J6-2B (See Note 4)		
 CQM1 (for one/two axes) CQM1H-PLB21 Pulse I/O Board	(See Note 3)  Cable for CQM1H-PLB21 XW2Z-□□□J-A3	(See Note 3)  Servo Terminal Unit for CQM1H-PLB21 XW2B-20J6-3B (See Note 1)		

- Note: 1. Has the functions of the conventional XW2B-20J6-1, XW2B-40J6-2 and XW2B-20J6-3.  
 2. Two cables will be required on the Servo driver side if the C200H-NC211 (for two axes) is used.  
 3. Two cables each are required on the Position Control Terminal Block and Position Control Module side and on the Servo Driver side if the CQM1H-PLB21 is used for two axes.  
 4. Two cables each will be required on the Position Control Terminal Block and Position Control Module side and on the Servo Driver side if the C200HW-NC413 (four axes) is used.

## Specifications

### ■ POSITION CONTROL TERMINAL BLOCKS

Item	XW2B-□□J6-□B
Rated current	1 A at a temperature of 30°C (86°F) max.
Rated voltage	24 VdC
Insulation resistance	5 MΩ min. at 500 VDC
Dielectric strength	500 VAC for 1 minute with a current leakage of 1 mA max.
Enclosure rating	IP00
Electrical protection	Class 0
Ambient temperature	Operating: -0°C to 55°C (32°F to 131°F)

### ■ CONNECTORS

Item	XW2Z-□J-A□/-B□
Rated current	1 A
Rated voltage	24 VDC
Contact resistance	20 mΩ max. with 100 mA max. at 20 mV max. (See Note 1)
Insulation resistance	5 MΩ min. at 500 VDC
Dielectric strength	500 VAC for 1 minute with a current leakage of 1 mA max. (See Note 2)
Enclosure rating	IP00
Electrical protection	Class 0
Ambient temperature	Operating: 0°C to 55°C (32°F to 131°F)

Note: 1. The resistance indicated is the contact resistance of the connector.

2. The voltage indicated is the dielectric strength of the connector.

# Dimensions

Unit: mm (inch)

## POSITION CONTROL TERMINAL BLOCKS

### XW2B-20J6-1B

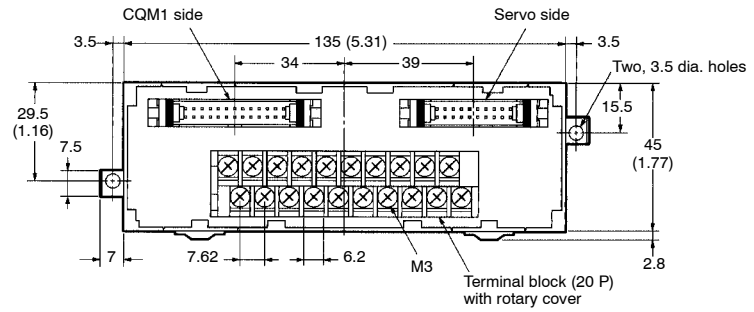
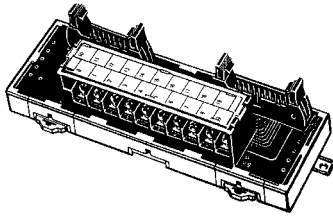

#### Connection to Terminal Block

The terminal signal name varies with the servo driver. Refer to the Operation Manual of the servo driver in use.

Identify the servo driver in use by writing the name on the terminal nameplates provided. Affix the nameplate to the terminal cover.

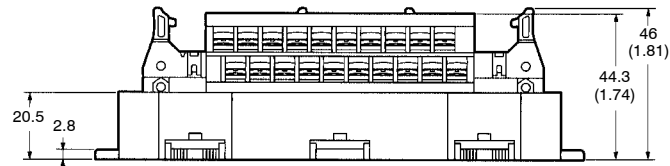

Note: The terminal block has a terminal pitch of 7.62 mm.

#### Connection to One Axis Position Control Modules C200H-NC112-U/C200HW-NC113-U

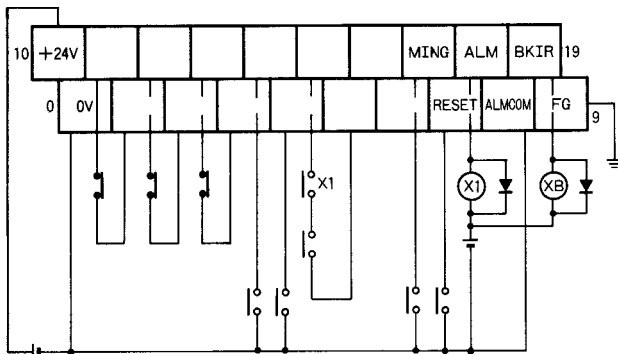

- Note: 1. Use mode 2 for origin search.
- 2. The XB contact is used to turn the electromagnetic brake ON and OFF.
- 3. The open terminal must be left unconnected.
- 4. 0 V and Common terminals are connected internally.
- 5. The suitable crimp terminal is R1.25-3 (round or fork type).



**XW2B-20J6-3B**

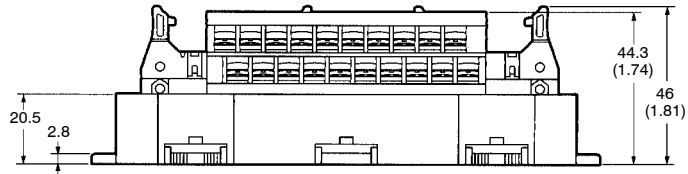
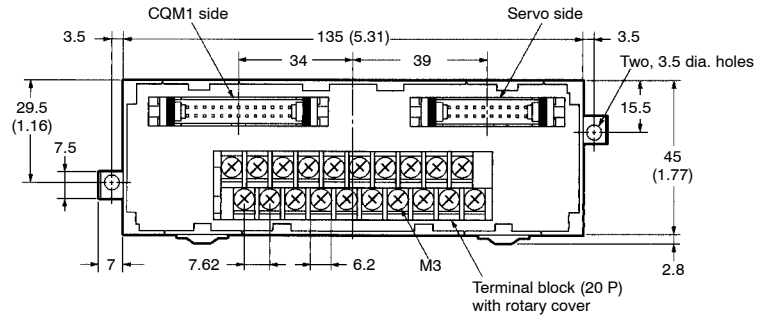
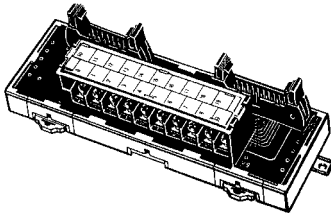

Note: The terminal block has a terminal pitch of 7.62 mm.

**Connection to Terminal Block**

The terminal signal name varies with the servo driver. Refer to the Operation Manual of the servo driver in use.

Identify the servo driver in use by writing the name on the terminal nameplates provided. Affix the nameplate to the terminal cover.

**Connection to Position Control PLC  
CQM1H-PLB21 for 1- or 2-Axis Control**

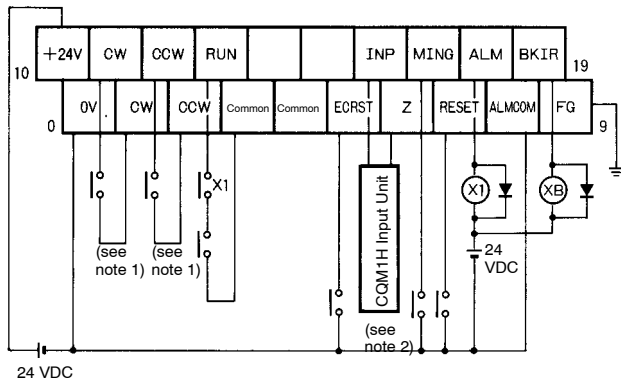

- Note: 1. When this signal is input, the output pulses of the CQM1H can be input to the high-speed counters directly.
- 2. Input this signal output to the CQM1H input modules
- 3. The XB contact is used to turn the electromagnetic brake on and off.
- 4. Phase Z is an open collector output.
- 5. The open terminal must be left unconnected.
- 6. 0 V and common terminals are connected internally.
- 7. The suitable crimp terminal is R1.25-3 (round or fork type).



■ XW2Z CONNECTING CABLES

Use the cables to connect the PLC Position Control Module to the XW2B Position Control Terminal Blocks.

For C200H-NC112 Use

XW2Z-□□□J-A1

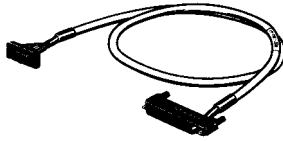

Connector

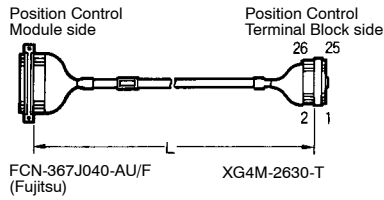

Wiring Diagram  
XW2Z-□□□J-A1

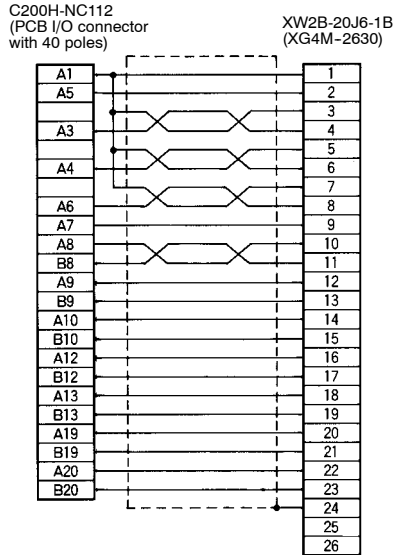

For C200HW-NC113 Use

XW2Z-□□□J-A6

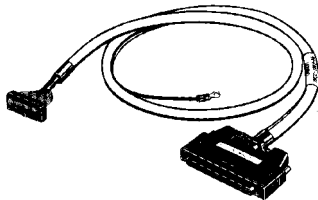

Connector

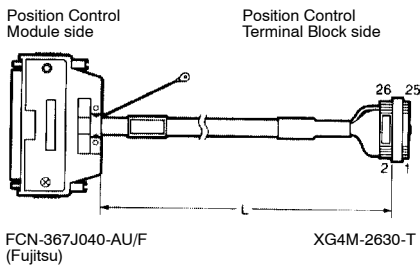

Wiring Diagram  
XW2Z-□□□J-A6

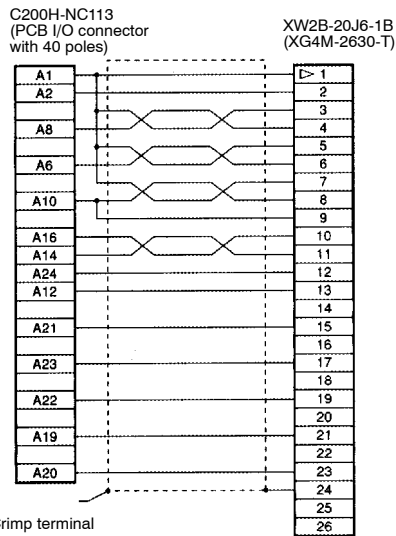

For C200H-NC211 Use

XW2Z-□□□J-A2

Wiring Diagram  
XW2Z-□□□J-A2

C200H-NC211  
(Multi-pole square  
connector with 34 poles)

XW2B-40J6-2B  
(XG4M-3430)

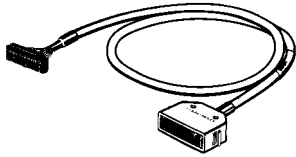

Connector

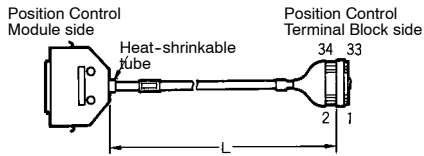

MR-34LF  
(Honda Tsushin Kogyo)

XG4M-3430-T

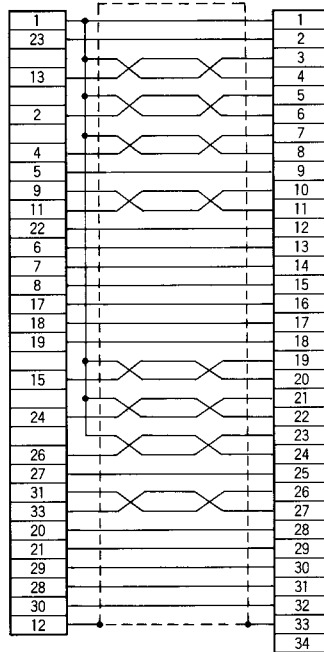

For C200HW-NC213/NC413 Use

XW2Z-□□□J-A7

Wiring Diagram  
XW2Z-□□□J-A7

C200H-NC213/NC413  
(Multi-pole square  
connector with 34 poles)

XW2B-40J6-2B  
(XG4M-3430-T)

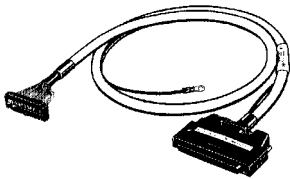

Connector

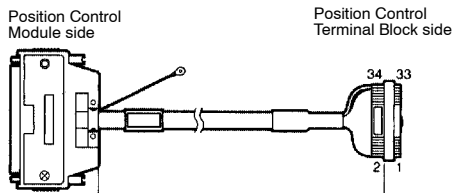

MR-34LF  
(Honda Tsushin Kogyo)

XG4M-3430-T

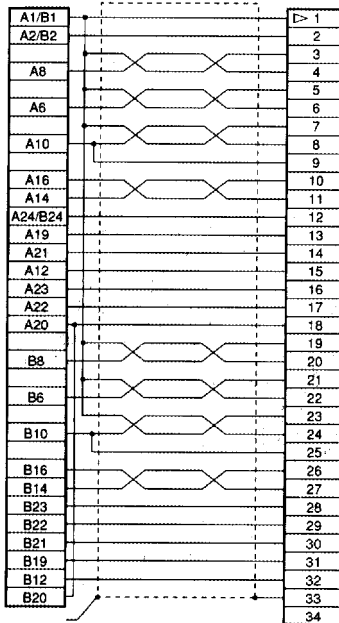

**For CQM1 Use**

XW2Z-□□□J-A3

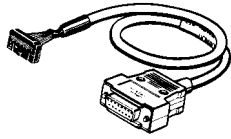

**Connector**

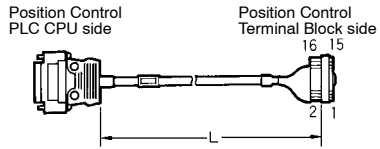

XM2D-1501 Socket  
XM2S-1511 Hood

XG4M-1630-T

**Wiring Diagram**  
XW2Z-□□□J-A3

CQM1H-PLB21 (XM2D-1501)

XW2B-20J6-3B (XG4M-1630)

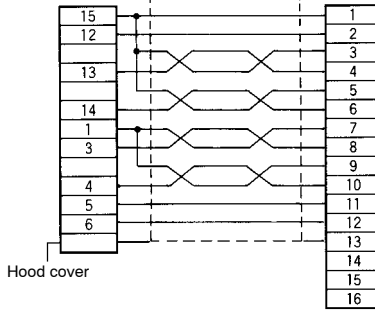

**For U-Series Servo Driver and Servo Terminal Block**

XW2Z-□□□J-B1

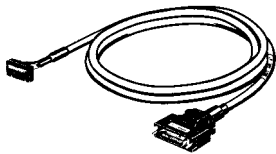

**Connector**

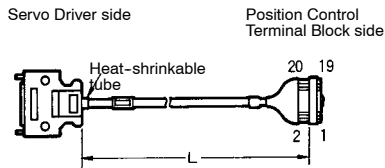

10136-3000VE Plug  
10336-52A0-008 Hood (both Sumitomo 3M)

XG4M-2030-T

**Wiring Diagram**  
XW2Z-□□□J-B1

R88D-UP□□□□ (Half-pitch connector with 36 poles)

XW2B-□□J6-□B (XG4M-2030)

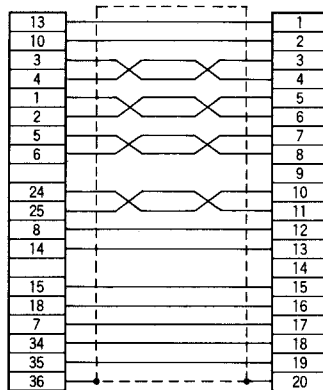

## For W-Series Servo Driver and Servo Terminal Block

XW2Z-□□□J-B4

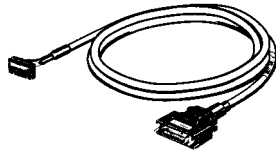
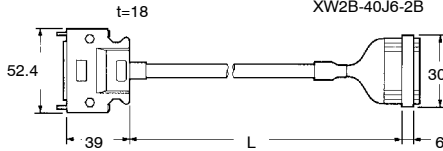
**Connector**Servo Driver side  
R88D-WT□Position Control  
Terminal Block side  
XW2B-20J6-1B  
XW2B-40J6-2B**Wiring Diagram**  
XW2Z-□□□J-B4

Position Control Terminal Block

Servo Drive

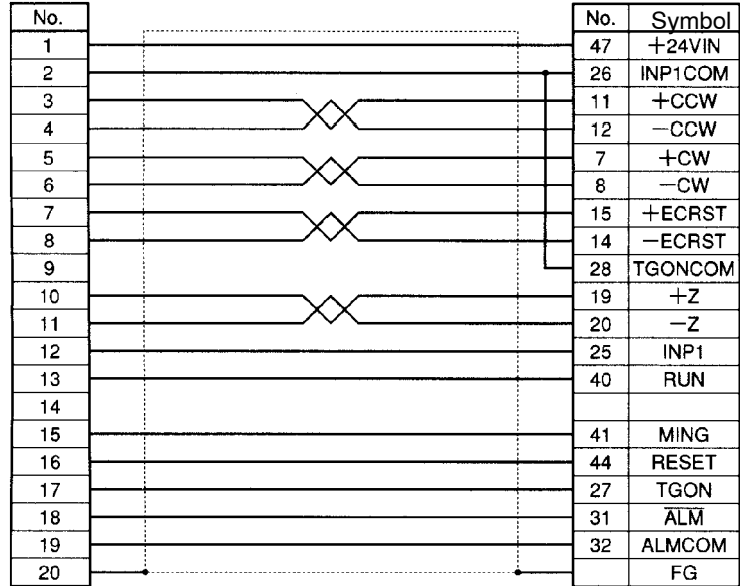

Cable: AWG28 × 4P + AWG28 × 9C

## Precautions

### ■ WIRING

The open terminal must be left unconnected.

0 V and common terminals are connected internally.

Do not wire the Servo Screw Terminal Block while power is supplied to the unit, or the terminals may be short-circuited with the cable and the Unit may malfunction.

### ■ TERMINAL WIRE CONNECTIONS

The suitable crimp terminal is R1.25-3 (round or fork type).

#### Terminal Screw Tightening Torque

When connecting crimp terminals or wires to the terminal block, be sure to tighten each crimp terminal or wire to 0.5 to 0.8 N • m (4.9 to 7.8 kgf • cm).

### ■ TRACK MOUNTING

More than one XW2B Position Control Screw Terminal Block can be densely mounted to a DIN track, in which case, move the mounting stays from both sides of the XW2B to the bottom of the XW2B.

Secure both ends of the XW2B with end plates.

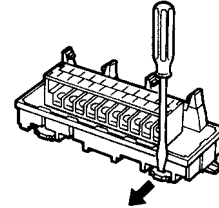
**NOTE: DIMENSIONS SHOWN ARE IN MILLIMETERS. To convert millimeters to inches divide by 25.4.****OMRON**®**OMRON ELECTRONICS LLC**One East Commerce Drive  
Schaumburg, IL 60173**1-800-55-OMRON****OMRON ON-LINE**Global - <http://www.omron.com>  
USA - <http://www.omron.com/oei>  
Canada - <http://www.omron.com/oci>**OMRON CANADA, INC.**885 Milner Avenue  
Scarborough, Ontario M1B 5V8**416-286-6465**