

	Page		Page
General		Thyristors	
Contents	I	Discretes Phase Control Thyristors	72
Certified Management Systems	II	Thyristor / Diode Modules	78, 137
Alphanumeric Index	III	Thyristor Modules	81, 136
Symbols and Terms	XVII	Accessories & Design Information	85
Nomenclature	XIX	Rectifier Bridges	
IXYS		Rectifier Bridges with Fast Diodes	86
New Packages		1~ Rectifier Bridges	87
ISOPLUS™ family		1~ Rectifier Bridges, half controlled	88
ISOPLUS-SMPD™	5	3~ Rectifier Bridges	89
ISOPLUS-DIL™	10	3~ Rectifier Bridges with Brake Unit	92
ISOPLUS i4-PAC™	11	3~ Rectifier Bridges, half controlled	93
IGBT Discretes		AC Controller / Triac	94
600V / 650V & 900V & 1200V XPT	16	1~ / 3~ High Voltage Rectifiers	95
NPT IGBTs / G-Series PT IGBT's	21	Braking Rectifier Assemblies	95
High Voltage Types 1700V up to 4500 V	23	Protection Devices	
BiMOSFETs 1600V up to 3600 V	25	Break-over Diodes (BOD)	96
IGBT Modules		Fast Break-over Diodes (BOD)	98
CBI Modules	27	IXYS ICD	
Six-Packs	29	Gate Drivers & Power Relays	
Multi Level, CBI and 6-Pack in <i>MiniPack2B</i> Housing	31	99	
Half Bridge and Boost Modules in <i>SimBUS F</i> Housing	32	IXYS UK	
Full Bridge and Solar Inverter Modules	33	Application Notes & Technical Information	107
Half Bridge and Buck / Boost in 34 mm and 62 mm wide Modules	34	Rectifier Diodes	108
Power MOSFETs		Fast Recovery Diodes	112
Trench MOSFETs / HiPerFETs (Fast Body Diode)	37	Soft Recovery Diodes	113
TrenchT2™ MOSFETs / HiPerFETs (FBD)	39	Extra Fast Recovery Diodes	116
Polar™ MOSFETs / HiPerFETs (FBD)	41	High Power Sonic FRD's	117
PolarP2™ MOSFETs / HiPerFETs (FBD)	47	Phase Control Thyristors	118
PolarP3™ HiPerFETs (FBD)	47	Medium Voltage Thyristors	123
X-Class Power MOSFETs and SiC MOSFETs	49	Fast Turn-Off Thyristors	125
Q3-Class HiPerFET (Fast Body Diode)	50	Distributed Gate Thyristors	127
Very High Voltage (up to 4500 V) / Legacy MOSFETs	51	Asymmetric and Pulse Thyristors	132
LinearL2™ Power MOSFETs	52	GTOs	133
Depletion-Mode MOSFETs	53	Insulated Gate Bi-polar Transistors - <i>Press-Pack IGBTs</i>	134
PolarP™ and TrenchP™ P-channel MOSFETs	54	Press-Pack IGBT Gate Drive Units	135
CoolMOS™	56	Dual Thyristor /Single Thyristor Modules	136
MOSFET Modules	57	Thyristor / Diode Modules	137
Power Factor Correction Modules	58	Dual & Single Diode Modules	138
Diodes		Water Cooled Diode & Thyristor Modules	140
Schottky Gen ² Diodes	60	Power Semiconductor Assemblies	141
Schottky Diodes	62	Westack - Modular Solutions	144
Silicon Carbide Schottky Diodes	63	WestackLITE - Modular Solutions	146
HiPerDyn™ FREDs & Dual Ultrafast Diodes	63	Power Semiconductor Accessories	148
HiPerFRED ² ™ & HiPerFRED™ Diodes	64	Bar Clamps / Box Clamps	149
Sonic-FRDs™ Diodes	66	Coolers / Heatsinks	155
FRED Diodes	67	Snubber Capacitors / DC Link Capacitors	157
FRED & HiPerFRED™ Modules & Semifast Diodes	68	Power Semiconductor Chips @ DCB Ceramic Substrates	
Rectifier & Avalanche Types	69	159	
Studs: Rectifier & Avalanche Diodes & Thyristors	71	Application Notes Highlights	
Rectifier Diode Modules	75, 138	160	
		Outline Drawings	
		IXYS UK	O-01
		IXYS	O-31

Certified Management Systems

Certificates



ISO 9001:2008



ISO 9001:2008



ISO/TS 16949:2009
(includes ISO 9001:2008)

ISO 14001:2009

OHSAS 18001:2007

DIN EN ISO 50001:2011

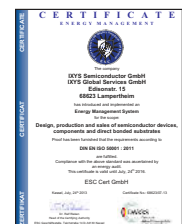

ISO 9001:2008



Alphanumeric Index

- > New
- Not for new design
- ◇ Under development

IXYS

C		D		E		F		G		H		I		J		K		L		M		N		O		P		Q		R		S		T		U		V		W		X		Y		Z																																																																																																																																																																																																																			
>	CLA 5E1200PZ	2, 72	>	DAA 10EM1800PZ	2, 70	>	DPF 60C200HJ	64	>	DSA 17-18A	71	>	DSA 20C45PB	60	>	DSA 20C60PN	60	>	DSA 20C100PB	60	>	DSA 20C100PN	60	>	DSA 20C150PB	61	>	DSA 20C150PN	61	>	DSA 30C45HB	60	>	DSA 30C45PB	60	>	DSA 30C45PC	60	>	DSA 30C60PB	60	>	DSA 30C100HB	60	>	DSA 30C100PB	60	>	DSA 30C100PN	60	>	DSA 30C100QB	60	>	DSA 30C150HB	61	>	DSA 30C150PB	61	>	DSA 30C200IB	61	>	DSA 30C200PB	61	>	DSA 30I100PA	60	>	DSA 30I150PA	61	>	DSA 35-12A	71	>	DSA 35-16A	71	>	DSA 35-18A	71	>	DSA 50C100HB	60	>	DSA 50C100QB	60	>	DSA 50C150HB	61	>	DSA 60C45HB	60	>	DSA 60C45PB	60	>	DSA 60C60HB	60	>	DSA 60C60PB	60	>	DSA 60C100PB	60	>	DSA 60C150PB	61	>	DSA 70C100HB	60	>	DSA 70C150HB	61	>	DSA 70C200HB	61	>	DSA 75-12B	71	>	DSA 75-16B	71	>	DSA 75-18B	71	>	DSA 80C45HB	60	>	DSA 80C100PB	60	>	DSA 90C200HB	3, 61	>	DSA 120C150QB	61	>	DSA 120X150LB	9, 61	>	DSA 120X200LB	9, 61	>	DSA 240X150NA	61	>	DSA 240X200LB	61	>	DSA 240X200NA	61	>	DSA 300I45NA	60	>	DSA 300I100NA	60	>	DSA 300I200NA	60	>	DSA 320A100NB	60	>	DSA 600A150NB	61	>	DSAI 17-12A	71	>	DSAI 17-16A	71	>	DSAI 17-18A	71	>	DSAI 35-12A	71	>	DSAI 35-16A	71	>	DSAI 35-18A	71	>	DSAI 75-12B	71	>	DSAI 75-16B	71	>	DSAI 75-18B	71	>	DSB 10I45PM	60	>	DSB 10P60PN	60	>	DSB 15IM45IB	60	>	DSB 20C60PN	60	>	DSB 20I15PA	60	>	DSB 30C30PB	60	>	DSB 30C45HB	60	>	DSB 30C45PB	60	>	DSB 30C60PB	60	>	DSB 40C15PB	60	>	DSB 60C30HB	60	>	DSB 60C30PB	60	>	DSB 60C45HB	60	>	DSB 60C45PB	60	>	DSB 60C60HB	60	>	DSB 60C60PB	60	>	DSB 80C45HB	60	>	DSDI 60-14A	68	>	DSDI 60-16A	68	>	DSDI 60-18A	68	>	DSEC 16-06A	65

Alphanumeric Index

- New
- Not for new design
- ✦ Under development

DSEC 16-06AC	65	DSEP 29-12A	65	DSS 2x101-015A	63	I	
DSEC 16-12A	65	DSEP 30-06A	65	DSS 2x101-02A	63	➤ ITF 38IF1200HJ	21
DSEC 16-12AS	65	DSEP 30-06B	65	DSS 2x111-008A	62	✦ ITF 40PF1200DHGTLB	8
DSEC 29-06AC	65	DSEP 30-06BR	65	DSS 2x121-0045B	62	➤ ITF 40PG1200DHGLB	8
DSEC 30-06A	65	DSEP 30-12A	65	DSS 2x160-0045A	62	➤ IXA 411200UC	21
DSEC 30-06B	65	DSEP 30-12AR	65	DSS 2x160-01A	62	✦ IXA 41F1200PZ	2, 21
DSEC 30-12A	65	DSEP 30-12CR	63	DSS 2x200-0008D	62	IXA 41F1200TC	21
DSEC 59-06BC	65	DSEP 2x31-03A	65	DSSK 10-018A	63	IXA 41F1200UC	21
DSEC 60-06A	65	DSEP 2x31-06A	65	DSSK 16-01A	62	IXA 121F1200HB	21
DSEC 60-06B	65	DSEP 2x31-06B	65	DSSK 16-01AS	62	IXA 121F1200PB	21
DSEC 60-12A	65	DSEP 2x31-12A	65	DSSK 18-0025BS	62	IXA 121F1200TC	21
DSEC 120-12AK	65	DSEP 40-03AS	65	DSSK 20-0045B	62	IXA 171F1200HJ	21
DSEC 240-04A	65	DSEP 60-06A	65	DSSK 20-015A	63	IXA 2011200PB	21
DSEC 240-06A	65	DSEP 60-06AT	65	DSSK 28-0045BS	62	✦ IXA 2011200PZ	2, 21
DSEE 15-12CC	63	DSEP 60-12A	65	DSSK 28-006BS	62	IXA 201F1200HB	21
DSEE 29-12CC	63	DSEP 2x60-12A	65	DSSK 28-01AS	62	IXA 20PG1200DHGLB	8
DSEE 30-12A	63	DSEP 60-12AR	65	DSSK 30-01A	62	➤ IXA 20PT1200LB	8
DSEE 55-24N1F	13, 63	DSEP 2x61-03A	65	DSSK 30-018A	63	IXA 20RG1200DHGLB	8
DSEI 8-06A	67	DSEP 2x61-06A	65	DSSK 38-0025B	62	IXA 271F1200HJ	21
DSEI 8-06AS	67	DSEP 2x61-12A	65	DSSK 38-0025BS	62	IXA 30PG1200DHGLB	8
DSEI 12-06A	67	➤ DSEP 75-06AR	65	DSSK 40-0015B	62	IXA 30RG1200DHGLB	8
DSEI 12-06AS	67	DSEP 2x91-03A	65	DSSK 40-006B	62	IXA 331F1200HB	21
DSEI 12-10A	67	DSEP 2x91-06A	65	DSSK 40-008B	62	IXA 371F1200HJ	21
DSEI 12-12A	67	DSEP 2x101-04A	65	DSSK 48-0025B	62	➤ IXA 4014000KN	24
DSEI 12-12AZ	2, 67	DSI 17-08A	71	DSSK 48-003B	62	IXA 40PG1200DHGLB	8
DSEI 19-06AS	67	DSI 17-12A	71	DSSK 48-003BS	62	IXA 40RG1200DHGLB	8
DSEI 20-12A	67	DSI 30-08A	69	DSSK 50-0025B	62	IXA 451F1200HB	21
DSEI 2x30-04C	67	DSI 30-08AC	69	DSSK 50-01A	62	IXA 5511200HJ	21
DSEI 30-06A	67	DSI 30-08AS	69	DSSK 50-015A	63	✦ IXA 601F1200DHGLB	8
DSEI 2x30-06C	67	DSI 30-12A	69	DSSK 60-0045A	62	IXA 601F1200NA	21
DSEI 30-10A	67	DSI 30-12AS	69	DSSK 60-0045B	62	IXA 7011200NA	21
DSEI 30-10AR	67	DSI 30-16A	69	DSSK 60-015A	63	IXA 70R1200NA	21
DSEI 2x30-10B	67	DSI 30-16AS	69	DSSK 60-015AR	63	✦ IXA 851F1200DHGLB	8
DSEI 30-12A	67	DSI 35-08A	71	DSSK 60-02A	63	✦ IXA 100XF650LB	8
DSEI 2x30-12B	67	DSI 35-12A	71	DSSK 60-02AR	63	➤ IXA 2201650NA	21
DSEI 2x31-04C	67	DSI 45-08A	70	DSSK 70-0015B	62	➤ IXBA 10N300HV	2, 26
DSEI 2x31-06C	67	DSI 45-12A	70	DSSK 70-003B	62	IXBA 12N300HV	2
DSEI 2x31-10B	67	DSI 45-16A	70	DSSK 70-008A	62	➤ IXBA 14N300HV	2, 26
DSEI 2x31-12B	67	DSI 45-16AR	70	DSSK 70-008AR	62	➤ IXBA 16N170AHV	2, 25
DSEI 36-06AS	67	DSI 2x55-12A	70	DSSK 80-0008D	62	IXBF 9N160G	12, 25
DSEI 60-02A	67	DSI 2x55-16A	70	DSSK 80-0025B	62	➤ IXBF 10N300C	26
DSEI 2x60-04C	67	DSI 75-08B	71	DSSK 80-003B	62	IXBF 12N300	12
DSEI 60-06A	67	DSI 75-12B	71	DSSK 80-0045B	62	➤ IXBF 14N300	12, 26
DSEI 60-10A	67	DSIK 45-16AR	70	DSSK 80-006B	62	➤ IXBF 15N300C	12, 26
DSEI 60-12A	67	DSP 8-08A	69	DSSK 80-006BR	62	IXBF 20N300	12
DSEI 2x61-02A	67	DSP 8-08AS	69	DSSS 30-01AR	62	➤ IXBF 20N360	12, 26
DSEI 2x61-04C	67	DSP 8-08S	69	DSSS 35-008AR	62	➤ IXBF 22N300	12, 26
DSEI 2x61-06C	67	DSP 8-12A	69			➤ IXBF 28N300	12, 26
DSEI 2x61-06P	67	DSP 8-12AC	69	F		IXBF 32N300	12, 26
DSEI 2x61-10B	67	DSP 8-12AS	69	FBE 22-06N1	13, 86	IXBF 40N160	12, 25
DSEI 2x61-12B	67	DSP 8-12S	69	FBO 16-12N	13, 58, 87	IXBF 42N300	12, 26
DSEI 2x61-12P	67	DSP 25-12A	69	FBO 40-12N	13, 58, 87	➤ IXBF 50N360	12, 26
DSEI 2x101-06A	67	DSP 25-12AT	69	FBS 10-06SC	13, 63, 86	IXBF 55N300	12, 26
DSEI 2x101-06P	67	DSP 25-16A	69	FBS 10-12SC	13, 63, 86	IXBH 5N160G	25
DSEI 2x101-12A	67	DSP 25-16AR	69	FBS 16-06SC	13, 63, 86	IXBH 6N170	25
DSEI 2x101-12P	67	DSP 25-16AT	69	FDM 47-06KC5	12, 56	IXBH 9N160G	25
DSEI 120-06A	67	DSP 45-12A	70	FID 60-06D	12, 58	IXBH 10N170	25
DSEI 120-12A	67	DSP 45-12AZ	3, 70	FII 30-06D	12	➤ IXBH 10N300	26
DSEI 2x121-02A	67	DSP 45-16A	70	FII 40-06D	12	IXBH 10N300HV	1, 26
DSEI 2x161-02P	67	DSP 45-16AR	70	FMD 15-06KC5	12, 56, 58	IXBH 14N300HV	1, 26
DSEI 2x161-06P	67	DSP 45-16AZ	3, 70	○ FMD 21-05QC	12, 58	IXBH 16N170	25
DSEI 2x161-12P	67	➤ DSP 45-18A	70	FMD 40-06KC	12, 56, 58	IXBH 16N170A	25
DSEK 60-02A	67	DSS 6-0025BS	62	FMD 47-06KC5	12, 56, 58	IXBH 20N360HV	1, 26
DSEK 60-02AR	67	DSS 6-0045AS	62	FMM 22-05PF	12	IXBH 22N300HV	1, 26
DSEK 60-06A	67	DSS 6-015AS	63	FMM 22-06PF	12	IXBH 24N170	25
DSEK 60-12A	67	DSS 10-0045B	62	FMM 50-025TF	12	IXBH 32N300	26
DSEP 6-06AS	65	DSS 10-006A	62	FMM 60-02TF	12	IXBH 40N160	25
DSEP 6-06BS	65	DSS 10-01A	62	FMM 75-01F	12	IXBH 42N170	25
DSEP 8-06A	65	DSS 10-01AS	62	FMM 150-0075X2F	12	IXBH 42N170A	25
DSEP 8-06B	65	DSS 16-0045A	62	FMP 26-02P	12	➤ IXBH 42N300HV	26
DSEP 8-12A	65	DSS 16-0045AS	62	FMP 36-015P	12	IXBK 55N300	26
DSEP 12-12A	65	DSS 16-01A	62	FMP 76-010T	12	IXBK 64N250	25
DSEP 12-12AZ	2, 65	DSS 16-01AS	62	FUE 30-12N1	13, 86	IXBK 75N170	25
DSEP 12-12B	65	DSS 17-06CR	63	FUO 22-12N	13, 89	IXBK 75N170A	25
DSEP 12-12BZ	2, 65	DSS 20-0015B	62	FUO 22-16N	13, 89	➤ IXBL 20N300C	26
DSEP 15-06A	65	DSS 20-01AC	62	FUO 50-16N	13, 89	➤ IXBL 60N360	26
DSEP 15-06AS	65	DSS 25-0025B	62	FUS 45-0045B	13, 62, 86	IXBL 64N250	25
DSEP 15-06B	65	DSS 25-0045A	62	G		IXBN 42N170A	25
DSEP 15-06BS	65	DSS 40-0008D	62	GBO 25-12NO1	87	IXBN 75N170	25
DSEP 15-12CR	63	DSS 2x41-01A	62	GBO 25-16NO1	87	IXBN 75N170A	25
DSEP 2x25-12C	63	DSS 60-0045B	62	GMM 3x60-015X2	10	IXBOD 1-06	96
DSEP 29-06A	65	DSS 2x61-0045A	62	GUO 40-08NO1	89	IXBOD 1-07	96
DSEP 29-06AS	65	DSS 2x61-01A	62	GUO 40-12NO1	89	IXBOD 1-08	96
DSEP 29-06B	65	DSS 2x81-0045B	62	GUO 40-16NO1	89	IXBOD 1-09	96

Alphanumeric Index

> New
 ○ Not for new design
 ◇ Under development

IXBOD 1-10	96	IXBOD 2-29R	98	IXFA 10N60P	44	IXFH 42N60P3	48
IXBOD 1-12R	96	IXBOD 2-29RD	98	IXFA 10N80P	45	IXFH 44N50P	44
IXBOD 1-12RD	96	IXBOD 2-30R	98	IXFA 12N50P	44	IXFH 44N50Q3	50
IXBOD 1-13R	96	IXBOD 2-30RD	98	IXFA 14N60P	44	> IXFH 46N30T	38
IXBOD 1-13RD	96	IXBOD 2-31R	98	IXFA 14N60P3	48	IXFH 50N30Q3	50
IXBOD 1-14R	96	IXBOD 2-31RD	98	IXFA 16N50P	44	IXFH 50N50P3	48
IXBOD 1-14RD	96	IXBOD 2-32R	98	IXFA 16N50P3	48	IXFH 50N60P3	48
IXBOD 1-15R	96	IXBOD 2-32RD	98	IXFA 16N60P3	48	> IXFH 50N60X	49
IXBOD 1-15RD	96	IXBOD 2-33R	98	> IXFA 18N60X	49	IXFH 52N30P	43
IXBOD 1-16R	96	IXBOD 2-33RD	98	IXFA 20N50P3	48	IXFH 52N50P2	47
IXBOD 1-16RD	96	IXBOD 2-34R	98	IXFA 22N60P3	48	IXFH 60N50P3	48
IXBOD 1-17R	96	IXBOD 2-34RD	98	> IXFA 24N60X	49	IXFH 69N30P	43
IXBOD 1-17RD	96	IXBOD 2-35R	98	IXFA 26N50P3	48	IXFH 70N20Q3	50
IXBOD 1-18R	96	IXBOD 2-35RD	98	> IXFA 36N30P3	47	IXFH 70N30Q3	50
IXBOD 1-18RD	96	IXBOD 2-36R	98	IXFA 76N15T2	40	IXFH 74N20P	43
IXBOD 1-19R	96	IXBOD 2-36RD	98	IXFA 102N15T	38	IXFH 86N30T	38
IXBOD 1-19RD	96	IXBOD 2-37R	98	IXFA 110N15T2	40	IXFH 88N30P	43
IXBOD 1-20R	96	IXBOD 2-37RD	98	IXFA 130N10T	38	IXFH 94N30P3	47
IXBOD 1-20RD	96	IXBOD 2-38R	98	IXFA 130N10T2	40	IXFH 94N30T	38
IXBOD 1-21R	96	IXBOD 2-38RD	98	IXFA 180N10T2	40	IXFH 96N15P	43
IXBOD 1-21RD	96	IXBOD 2-39R	98	IXFA 230N075T2	40	IXFH 96N20P	43
IXBOD 1-22R	96	IXBOD 2-39RD	98	IXFB 30N120P	46	IXFH 100N25P	43
IXBOD 1-22RD	96	IXBOD 2-40R	98	IXFB 40N110P	46	IXFH 102N15T	38
IXBOD 1-23R	96	IXBOD 2-40RD	98	IXFB 40N110Q3	50	IXFH 110N10P	43
IXBOD 1-23RD	96	IXBOD 2-41R	98	IXFB 44N100P	46	IXFH 110N15T2	40
IXBOD 1-24R	96	IXBOD 2-41RD	98	IXFB 44N100Q3	50	IXFH 110N25T	38
IXBOD 1-24RD	96	IXBOD 2-42R	98	IXFB 52N90P	45	IXFH 120N15P	43
IXBOD 1-25R	96	IXBOD 2-42RD	98	IXFB 60N80P	45	IXFH 120N20P	43
IXBOD 1-25RD	96	IXBOD 2-43R	98	IXFB 62N80Q3	50	IXFH 120N25T	38
IXBOD 1-26R	96	IXBOD 2-44R	98	IXFB 82N60P	44	IXFH 140N10P	43
IXBOD 1-26RD	96	IXBOD 2-45R	98	IXFB 82N60Q3	50	IXFH 150N15P	43
IXBOD 1-28R	96	IXBOD 2-46R	98	IXFB 100N50P	44	IXFH 150N17T2	40
IXBOD 1-28RD	96	IXBOD 2-47R	98	IXFB 100N50Q3	50	IXFH 150N20T	38
IXBOD 1-30R	96	IXBOD 2-48R	98	IXFB 110N60P3	48	IXFH 160N15T	38
IXBOD 1-30RD	96	IXBOD 2-49R	98	IXFB 120N50P2	47	IXFH 160N15T2	40
IXBOD 1-32R	96	IXBOD 2-50R	98	IXFB 132N50P3	48	IXFH 170N10P	43
IXBOD 1-32RD	96	IXBOD 2-51R	98	IXFB 170N30P	43	IXFH 230N075T2	40
IXBOD 1-34R	96	IXBOD 2-52R	98	IXFB 210N20P	43	IXFH 230N10T	38
IXBOD 1-36R	96	IXBOD 2-53R	98	IXFB 210N30P3	47	IXFH 320N10T2	40
IXBOD 1-38R	96	IXBOD 2-54R	98	IXFB 300N10P	43	IXFH 340N075T2	40
IXBOD 1-40R	96	IXBOD 2-55R	98	IXFH 5N100P	46	IXFH 400N075T2	40
IXBOD 1-42R	96	IXBOD 2-56R	98	IXFH 6N120P	46	IXFJ 26N50P3	3, 48
IXBOD 2-01	97	IXBP 5N160G	25	IXFH 7N100P	46	IXFK 20N120P	46
IXBOD 2-02	97	IXBR 42N170	25	IXFH 10N80P	45	IXFK 24N80P	45
IXBOD 2-03	97	IXBT 6N170	25	IXFH 10N100P	46	IXFK 24N100Q3	50
IXBOD 2-04	97	IXBT 10N170	25	IXFH 12N80P	45	IXFK 26N100P	46
IXBOD 2-05	97	IXBT 12N300HV	3	IXFH 12N90P	45	IXFK 26N120P	46
IXBOD 2-06	97	IXBT 16N170	25	IXFH 12N100P	46	IXFK 32N80P	45
IXBOD 2-07	97	IXBT 16N170A	25	IXFH 12N120P	46	IXFK 32N80Q3	50
IXBOD 2-08	97	> IXBT 16N170AHV	3, 25	IXFH 14N60P	44	IXFK 32N90P	45
IXBOD 2-09	97	IXBT 20N300HV	3	IXFH 14N60P3	48	IXFK 32N100P	46
IXBOD 2-10	97	> IXBT 20N360HV	3, 26	IXFH 14N80P	45	IXFK 32N100Q3	50
IXBOD 2-11	97	> IXBT 22N300HV	3, 26	IXFH 15N100P	46	IXFK 36N60P	44
IXBOD 2-12	97	IXBT 24N170	25	IXFH 15N100Q3	50	IXFK 40N90P	45
IXBOD 2-13	97	IXBT 32N300	26	IXFH 16N50P	44	IXFK 44N50P	44
IXBOD 2-14	97	IXBT 42N170	25	IXFH 16N50P3	48	IXFK 44N80P	45
IXBOD 2-15R	97	IXBT 42N170A	25	IXFH 16N60P3	48	IXFK 44N80Q3	50
IXBOD 2-15RD	97	IXBT 42N300HV	3, 26	IXFH 16N80P	45	IXFK 48N60P	44
IXBOD 2-16R	97	IXBX 28N300HV	1, 26	IXFH 16N120P	46	IXFK 48N60Q3	50
IXBOD 2-16RD	97	IXBX 50N360HV	1, 26	IXFH 18N60P	44	IXFK 64N50P	44
IXBOD 2-17R	97	IXBX 55N300	26	> IXFH 18N60X	49	IXFK 64N50Q3	50
IXBOD 2-17RD	97	IXBX 64N250	25	IXFH 18N90P	45	IXFK 64N60P	44
IXBOD 2-18R	97	IXBX 75N170	25	IXFH 18N100Q3	50	IXFK 64N60P3	48
IXBOD 2-18RD	97	IXBX 75N170A	25	IXFH 20N50P3	48	IXFK 64N60Q3	50
IXBOD 2-19R	97	IXCH 36N250	25	IXFH 20N80P	45	IXFK 74N50P2	47
IXBOD 2-19RD	97	IXCK 36N250	25	IXFH 20N100P	46	IXFK 78N50P3	48
IXBOD 2-20R	97	○ IXDH 20N120	21	IXFH 22N50P	44	IXFK 80N50P	44
IXBOD 2-20RD	97	○ IXDH 20N120D1	21	IXFH 22N60P	44	IXFK 80N50Q3	50
IXBOD 2-21R	97	○ IXDH 30N120	21	IXFH 22N60P3	48	IXFK 80N60P3	48
IXBOD 2-21RD	97	○ IXDH 30N120D1	21	> IXFH 24N60X	49	IXFK 88N30P	43
IXBOD 2-22R	97	○ IXDH 35N60B	21	IXFH 24N80P	45	> IXFK 90N60X	49
IXBOD 2-22RD	97	○ IXDH 35N60BD1	21	IXFH 24N90P	45	IXFK 94N50P2	47
IXBOD 2-23R	97	IXDN 55N120D1	21	IXFH 26N50P	44	IXFK 98N50P3	48
IXBOD 2-23RD	97	IXDN 75N120	21	IXFH 26N50P3	48	IXFK 102N30P	43
IXBOD 2-24R	97	○ IXDP 20N60B	21	IXFH 26N60P	44	IXFK 120N20P	43
IXBOD 2-24RD	97	○ IXDP 20N60BD1	21	IXFH 28N60P3	48	IXFK 120N25P	43
IXBOD 2-25R	97	○ IXDP 35N60B	21	IXFH 30N50P	44	IXFK 120N30P3	47
IXBOD 2-25RD	97	○ IXDR 30N120D1	21	IXFH 30N50Q3	50	IXFK 120N30T	38
IXBOD 2-26R	97	IXEL 40N400	24	IXFH 30N60P	44	IXFK 140N20P	43
IXBOD 2-26RD	97	IXFA 4N100P	46	> IXFH 30N60X	49	IXFK 140N25T	38
IXBOD 2-27R	97	IXFA 5N100P	46	IXFH 34N50P3	48	IXFK 140N30P	43
IXBOD 2-27RD	97	IXFA 6N120P	46	IXFH 36N50P	44	IXFK 150N15P	43
IXBOD 2-28R	97	IXFA 7N80P	45	IXFH 36N60P	44	IXFK 150N30P3	47
IXBOD 2-28RD	97	IXFA 7N100P	46	IXFH 42N50P2	47	IXFK 160N30T	38

Alphanumeric Index

- New
- Not for new design
- ✦ Under development

IXFK 170N10P	43	IXFP 7N100P	46	IXFT 24N90P	45	IXFZ 520N075T2	40
IXFK 170N20P	43	IXFP 10N60P	44	IXFT 26N60P	44	IXGA 12N120A3	22
IXFK 170N20T	38	IXFP 10N80P	45	IXFT 30N50P	44	IXGA 20N120A3	22
IXFK 180N15P	43	IXFP 12N50P	44	IXFT 30N50Q3	50	IXGA 20N120B3	22
IXFK 180N25T	38	IXFP 14N60P	44	IXFT 30N60P	44	➤ IXGA 20N250HV	2, 24
IXFK 200N10P	43	IXFP 14N60P3	48	➤ IXFT 30N60X	49	IXGA 36N60A3	22
IXFK 220N15P	43	IXFP 16N50P	44	IXFT 36N50P	44	IXGA 48N60A3	22
IXFK 220N17T2	40	IXFP 16N50P3	48	IXFT 36N60P	44	IXGF 20N250	12, 24
IXFK 230N20T	38	IXFP 16N60P3	48	IXFT 42N50P2	47	IXGF 20N300	12, 24
IXFK 240N15T2	40	➤ IXFP 18N60X	49	IXFT 44N50P	44	IXGF 25N250	12, 24
IXFK 250N10P	43	IXFP 20N50P3	48	IXFT 44N50Q3	50	IXGF 25N300	12, 24
IXFK 320N17T2	40	IXFP 22N60P3	48	➤ IXFT 46N30T	38	IXGF 30N400	12
IXFK 360N10T	38	➤ IXFP 24N60X	49	IXFT 50N30Q3	50	IXGF 32N170	12, 22
IXFK 360N15T2	40	IXFP 26N50P3	48	IXFT 50N50P3	48	IXGF 36N300	12, 24
IXFK 420N10T	38	➤ IXFP 36N30P3	47	IXFT 50N60P3	48	IXGF 6N170	22
IXFK 520N075T2	40	IXFP 76N15T2	40	➤ IXFT 50N60X	49	IXGH 6N170A	22
IXFL 30N120P	46	IXFP 102N15T	38	IXFT 52N50P2	47	IXGH 10N170	22
IXFL 32N120P	46	IXFP 110N15T2	40	IXFT 60N50P3	48	IXGH 10N170A	22
IXFL 36N110P	46	IXFP 130N10T	38	IXFT 69N30P	43	IXGH 10N300	24
IXFL 38N100P	46	IXFP 130N10T2	40	IXFT 70N20Q3	50	IXGH 12N120A3	22
IXFL 40N110P	46	IXFP 180N10T2	40	IXFT 70N30Q3	50	IXGH 16N170	22
IXFL 44N100P	46	IXFP 230N075T2	40	IXFT 86N30T	38	IXGH 16N170A	22
IXFL 60N80P	45	IXFQ 10N80P	45	IXFT 88N30P	43	IXGH 16N170AH1	22
IXFL 82N60P	44	IXFQ 12N80P	45	IXFT 94N30P3	47	IXGH 20N120A3	22
IXFL 100N50P	44	IXFQ 14N80P	45	IXFT 94N30T	38	IXGH 24N170	22
IXFL 132N50P3	48	IXFQ 20N50P3	48	IXFT 96N20P	43	IXGH 24N170A	22
IXFL 210N30P3	47	IXFQ 22N60P3	48	IXFT 120N15P	43	IXGH 24N170AH1	22
IXFN 20N120P	46	IXFQ 24N50P2	47	IXFT 120N25T	38	IXGH 25N250	24
IXFN 26N100P	46	➤ IXFQ 24N60X	49	IXFT 140N10P	43	IXGH 32N100A3	22
IXFN 26N120P	46	IXFQ 26N50P3	48	IXFT 150N17T2	40	IXGH 32N120A3	22
IXFN 30N120P	46	IXFQ 28N60P3	48	IXFT 150N20T	38	IXGH 32N170	22
IXFN 32N80P	45	➤ IXFQ 30N60X	49	IXFT 320N10T2	40	IXGH 32N170A	22
IXFN 32N100P	46	IXFQ 34N50P3	48	IXFT 340N075T2	40	IXGH 36N60A3	22
IXFN 32N100Q3	50	IXFQ 50N50P3	48	IXFT 400N075T2	40	IXGH 36N60A3D4	22
IXFN 32N120P	46	IXFQ 50N60P3	48	IXFX 20N120P	46	IXGH 48N60A3	22
IXFN 38N100P	46	➤ IXFQ 50N60X	49	IXFX 24N100Q3	50	IXGH 48N60A3D1	22
IXFN 40N90P	45	IXFQ 60N50P3	48	IXFX 26N100P	46	IXGH 56N60A3	22
IXFN 40N110P	46	IXFQ 94N30P3	47	IXFX 26N120P	46	IXGH 64N60A3	22
IXFN 40N110Q3	50	IXFR 15N100Q3	50	IXFX 32N80P	45	IXGH 72N60A3	22
IXFN 44N80P	45	IXFR 16N120P	46	IXFX 32N80Q3	50	IXGJ 50N60C4D1	3
IXFN 44N80Q3	50	IXFR 18N90P	45	IXFX 32N90P	45	IXGK 55N120A3H1	22
IXFN 44N100P	46	IXFR 20N80P	45	IXFX 32N100P	46	IXGK 72N60A3H1	22
IXFN 44N100Q3	50	IXFR 20N100P	46	IXFX 32N100Q3	50	IXGK 75N250	24
IXFN 48N60P	44	IXFR 20N120P	46	IXFX 40N90P	45	IXGK 82N120A3	22
➤ IXFN 50N120SiC	49	IXFR 24N80P	45	IXFX 44N80P	45	IXGK 100N170	22
IXFN 52N90P	45	IXFR 24N90P	45	IXFX 44N80Q3	50	IXGK 120N60A3	22
IXFN 56N90P	45	IXFR 24N100Q3	50	IXFX 48N60P	44	IXGK 120N120A3	22
IXFN 60N80P	45	IXFR 26N100P	46	IXFX 48N60Q3	50	IXGK 320N60A3	22
IXFN 62N80Q3	50	IXFR 26N120P	46	IXFX 64N50P	44	IXGL 75N250	24
IXFN 64N50P	44	IXFR 30N60P	44	IXFX 64N50Q3	50	IXGN 72N60A3	22
IXFN 64N60P	44	IXFR 32N80P	45	IXFX 64N60P	44	IXGN 100N170	22
IXFN 80N50P	44	IXFR 32N80Q3	50	IXFX 64N60P3	48	IXGN 120N60A3	22
IXFN 80N50Q3	50	IXFR 32N100P	46	IXFX 64N60Q3	50	IXGN 120N60A3D1	22
IXFN 80N60P3	48	IXFR 32N100Q3	50	IXFX 74N50P2	47	IXGN 320N60A3	22
IXFN 82N60P	44	IXFR 36N50P	44	IXFX 78N50P3	48	IXGN 400N60A3	22
IXFN 82N60Q3	50	IXFR 36N60P	44	IXFX 80N50P	44	IXGP 12N120A3	22
➤ IXFN 94N50P2	47	IXFR 40N90P	45	IXFX 80N50Q3	50	IXGP 20N120A3	22
IXFN 100N50P	44	IXFR 44N50P	44	IXFX 80N60P3	48	IXGP 20N120B3	22
IXFN 100N50Q3	50	IXFR 44N50Q3	50	➤ IXFX 90N60X	49	IXGP 36N60A3	22
IXFN 102N30P	43	IXFR 44N80P	45	IXFX 94N50P2	47	IXGP 48N60A3	22
IXFN 110N60P3	48	IXFR 48N60P	44	IXFX 98N50P3	48	IXGR 6N170A	22
IXFN 132N50P3	48	IXFR 48N60Q3	50	IXFX 120N25P	43	IXGR 16N170AH1	22
IXFN 140N20P	43	IXFR 64N50P	44	IXFX 120N30P3	47	IXGR 32N170AH1	22
IXFN 140N25T	38	IXFR 64N50Q3	50	IXFX 120N30T	38	IXGR 32N170H1	22
IXFN 140N30P	43	IXFR 64N60P	44	IXFX 140N25T	38	IXGR 55N120A3H1	22
IXFN 160N30T	38	IXFR 64N60Q3	50	IXFX 140N30P	43	IXGR 64N60A3	22
IXFN 170N30P	43	IXFR 80N50P	44	IXFX 150N30P3	47	IXGR 72N60A3	22
IXFN 180N15P	43	IXFR 80N50Q3	50	IXFX 160N30T	38	IXGR 72N60A3H1	22
IXFN 180N25T	38	IXFR 80N60P3	48	IXFX 170N20P	43	IXGT 6N170	22
IXFN 200N10P	43	IXFR 102N30P	43	IXFX 170N20T	38	IXGT 6N170A	22
IXFN 210N20P	43	IXFR 140N20P	43	IXFX 180N15P	43	IXGT 10N170	22
IXFN 210N30P3	47	IXFR 140N30P	43	IXFX 180N25T	38	IXGT 10N170A	22
IXFN 230N20T	38	IXFR 180N15P	43	IXFX 200N10P	43	IXGT 16N170	22
IXFN 240N15T2	40	IXFR 200N10P	43	IXFX 220N15P	43	IXGT 16N170A	22
IXFN 300N10P	43	IXFR 230N20T	38	IXFX 220N17T2	40	IXGT 16N170AH1	22
IXFN 320N17T2	40	IXFT 14N80P	45	IXFX 230N20T	38	IXGT 24N170	22
IXFN 360N10T	38	IXFT 15N100Q3	50	IXFX 240N15T2	40	IXGT 24N170A	22
IXFN 360N15T2	40	IXFT 16N80P	45	IXFX 250N10P	43	IXGT 24N170AH1	22
IXFN 420N10T	38	IXFT 16N120P	46	IXFX 320N17T2	40	IXGT 25N250	24
IXFN 520N075T2	40	IXFT 18N90P	45	IXFX 360N10T	38	IXGT 25N250HV	3, 24
IXFP 4N100P	46	IXFT 18N100Q3	50	IXFX 360N15T2	40	IXGT 32N100A3	22
IXFP 5N100P	46	IXFT 20N80P	45	IXFX 420N10T	38	IXGT 32N120A3	22
IXFP 6N120P	46	IXFT 20N100P	46	IXFX 520N075T2	40	IXGT 32N170	22
IXFP 7N80P	45	IXFT 24N80P	45	IXFZ 140N25T	38	IXGT 32N170A	22

Alphanumeric Index

➤ New
○ Not for new design
◇ Under development

IXGT 64N60A3	22	IXTA 36N30P	41	IXTH 30N60P	42	IXTN 550N055T2	39
IXGT 72N60A3	22	IXTA 36P15P	54	➤ IXTH 32N65X	49	IXTN 600N04T2	39
IXGT 72N60B3	22	IXTA 42N25P	41	IXTH 32P20T	55	IXTP 1N100	51
IXGX 32N170AH1	22	IXTA 44P15T	55	IXTH 36N50P	42	IXTP 1N100P	42
IXGX 32N170H1	22	IXTA 48N20T	37	IXTH 36P15P	54	IXTP 1N120P	42
IXGX 55N120A3H1	22	IXTA 48P05T	55	IXTH 40N50L2	52	IXTP 1R4N100P	42
IXGX 72N60A3H1	22	IXTA 50N20P	41	IXTH 44P15T	55	IXTP 1R4N120P	42
IXGX 75N250	24	IXTA 50N25T	37	IXTH 48P20P	54	IXTP 1R6N100D2	53
IXGX 82N120A3	22	IXTA 52P10P	54	IXTH 50N25T	37	IXTP 1R6N50D2	53
IXGX 100N170	22	IXTA 60N10T	37	IXTH 52P10P	54	➤ IXTP 2N65X2	49
IXGX 120N60A3	22	IXTA 60N20T	37	IXTH 60N20L2	52	IXTP 2N100	51
IXGX 120N120A3	22	IXTA 62N15P	41	➤ IXTH 64N10L2	52	IXTP 2N100P	42
IXGX 320N60A3	22	➤ IXTA 64N10L2	52	IXTH 68P20T	55	IXTP 02N120P	42
IXKC 13N80C	56	IXTA 70N075T2	39	IXTH 75N10L2	52	IXTP 2R4N120P	42
IXKC 20N60C	56	IXTA 75N10P	41	IXTH 76N25T	37	IXTP 3N50D2	53
IXKC 23N60C5	56	IXTA 76N25T	37	IXTH 76P10T	55	IXTP 3N100D2	53
IXKC 25N80C	56	IXTA 76P10T	55	➤ IXTH 80N075L2	52	IXTP 3N100P	42
IXKC 40N60C	56	➤ IXTA 80N075L2	52	IXTH 86N25T	37	IXTP 3N120	51
IXKF 40N60SCD1	12, 56	IXTA 80N10T	37	IXTH 88N30P	41	➤ IXTP 4N65X2	49
IXKF 40N60SCH1	12, 56	IXTA 80N12T2	39	IXTH 90P10P	54	IXTP 05N100	51
○ IXKH 20N60C5	56	IXTA 86N20T	37	IXTH 96N20P	41	IXTP 05N100P	42
IXKH 30N60C5	56	IXTA 90N055T2	39	IXTH 96N25T	37	IXTP 6N50D2	53
IXKH 35N60C5	56	IXTA 90N075T2	39	IXTH 96P085T	55	IXTP 6N100D2	53
IXKH 70N60C5	56	IXTA 96P085T	55	IXTH 102N20T	37	IXTP 06N120P	42
○ IXKK 85N60C	56	IXTA 100N04T2	39	IXTH 110N10L2	52	IXTP 08N50D2	53
IXKN 40N60C	56	IXTA 110N055T2	39	IXTH 110N25T	37	➤ IXTP 8N65X2	49
IXKN 45N80C	56	IXTA 120N04T2	39	IXTH 120P065T	55	IXTP 08N100D2	53
IXKN 75N60C	56	IXTA 120N075T2	39	IXTH 130N10T	37	IXTP 08N100P	42
IXKP 24N60C5	56	IXTA 120P065T	55	IXTH 130N20T	37	IXTP 08N120P	42
IXKR 25N80C	56	IXTA 130N065T2	39	IXTH 140P05T	55	IXTP 10N60P	42
IXKR 40N60C	56	IXTA 130N10T	37	IXTH 140P10T	55	IXTP 10P15T	55
IXKR 47N60C5	56	IXTA 140N055T2	39	IXTH 180N10T	37	IXTP 10P50P	54
IXKT 70N60C5	56	IXTA 140P05T	55	IXTH 200N10T	37	IXTP 12N50P	42
IXLF 19N250A	12, 24	IXTA 160N04T2	39	IXTH 260N055T2	39	IXTP 14N60P	42
IXTA 1N100	51	IXTA 170N075T2	39	IXTH 300N04T2	39	IXTP 15N50L2	52
IXTA 1N100P	42	IXTA 180N10T	37	IXTH 360N055T2	39	IXTP 15P15T	55
IXTA 1N120P	42	IXTA 200N055T2	39	IXTH 420N04T2	39	IXTP 16N50P	42
➤ IXTA 1N170DHV	2, 53	IXTA 220N04T2	39	IXTH 440N055T2	39	IXTP 18P10T	55
➤ IXTA 1N200P3HV	2, 51	IXTA 230N075T2	39	IXTH 450P2	47	➤ IXTP 20N65X	49
IXTA 1R4N100P	42	IXTA 260N055T2	39	IXTH 460P2	47	➤ IXTP 20N65XM	49
IXTA 1R4N120P	42	IXTA 300N04T2	39	IXTH 500N04T2	39	IXTP 24P085T	55
IXTA 1R6N100D2	53	IXTA 460P2	47	➤ IXTJ 3N150	3, 51	IXTP 26P10T	55
IXTA 1R6N50D2	53	IXTF 1N250	12, 51	➤ IXTJ 4N150	3, 51	IXTP 26P20P	54
IXTA 2N100	51	IXTF 1N450	12, 51	➤ IXTJ 6N150	3, 51	IXTP 28P065T	55
IXTA 2N100P	42	IXTF 02N450	12, 51	IXTK 5N250	51	➤ IXTP 32N65X	49
IXTA 02N250HV	2, 51	IXTF 200N10T	12, 37	IXTK 32P60P	54	➤ IXTP 32N65XM	49
IXTA 2R4N120P	42	IXTH 1N170DHV	1, 53	IXTK 40P50P	54	IXTP 32P05T	55
IXTA 3N50D2	53	➤ IXTH 1N200P3	51	IXTK 60N50L2	52	IXTP 32P20T	55
IXTA 3N100D2	53	IXTH 1N200P3HV	1, 51	IXTK 82N25P	41	IXTP 36N30P	41
IXTA 3N100D2HV	2, 53	IXTH 1N250	51	IXTK 88N30P	41	IXTP 36P15P	54
IXTA 3N100P	42	IXTH 1N300P3HV	1, 51	IXTK 90N25L2	52	IXTP 42N25P	41
IXTA 3N120	51	IXTH 1N450HV	1, 51	IXTK 90P20P	54	IXTP 44N10T	37
➤ IXTA 3N120HV	2, 51	IXTH 1R4N250P3	51	IXTK 100N25P	41	IXTP 44P15T	55
➤ IXTA 3N150HV	2, 51	➤ IXTH 1R8N220P3HV	51	IXTK 102N30P	41	IXTP 48N20T	37
➤ IXTA 4N65X2	49	IXTH 2N170D2	53	➤ IXTK 102N65X2	49	IXTP 48P05T	55
➤ IXTA 4N150HV	2, 51	IXTH 02N250	51	IXTK 110N20L2	52	IXTP 50N20P	41
IXTA 05N100	51	IXTH 02N450HV	1, 51	IXTK 120N20P	41	IXTP 50N25T	37
➤ IXTA 05N100HV	2, 51	IXTH 2R4N120P	42	IXTK 120N25P	41	IXTP 52P10P	54
IXTA 05N100P	42	IXTH 3N100P	42	IXTK 120P20T	55	IXTP 60N10T	37
IXTA 6N50D2	53	IXTH 3N120	51	IXTK 140N20P	41	IXTP 60N20T	37
IXTA 6N100D2	53	IXTH 3N150	51	IXTK 140N30P	41	IXTP 62N15P	41
IXTA 06N120P	42	IXTH 4N150	51	IXTK 150N15P	41	➤ IXTP 64N10L2	52
IXTA 08N50D2	53	➤ IXTH 04N300P3HV	51	IXTK 170N10P	41	IXTP 70N075T2	39
➤ IXTA 8N65X2	49	IXTH 05N250P3HV	51	IXTK 170P10P	54	IXTP 75N10P	41
IXTA 08N100D2	53	IXTH 6N50D2	53	IXTK 180N15P	41	IXTP 76N25T	37
➤ IXTA 08N100D2HV	2, 53	IXTH 6N100D2	53	IXTK 200N10L2	52	IXTP 76P10T	55
IXTA 08N100P	42	IXTH 6N120	51	IXTK 200N10P	41	➤ IXTP 80N075L2	52
IXTA 08N120P	42	IXTH 6N150	51	IXTK 210P10T	55	IXTP 80N10T	37
IXTA 10N60P	42	➤ IXTH 06N220P3HV	51	IXTK 550N055T2	39	IXTP 80N12T2	39
IXTA 10P15T	55	IXTH 10N100D2	53	IXTK 600N04T2	39	IXTP 86N20T	37
IXTA 10P50P	54	IXTH 10P50P	54	IXTL 2N450	51	IXTP 90N055T2	39
IXTA 12N50P	42	IXTH 15N50L2	52	IXTL 2x180N10T	37	IXTP 90N075T2	39
IXTA 14N60P	42	➤ IXTH 16N10D2	53	IXTN 5N250	51	IXTP 96P085T	55
IXTA 15N50L2	52	IXTH 16N20D2	53	IXTN 32P60P	54	IXTP 100N04T2	39
IXTA 15P15T	55	IXTH 16N50D2	53	IXTN 40P50P	54	IXTP 110N055T2	39
IXTA 16N50P	42	IXTH 16P60P	54	IXTN 60N50L2	52	IXTP 120N04T2	39
IXTA 18P10T	55	➤ IXTH 20N65X	49	IXTN 90N25L2	52	IXTP 120N075T2	39
➤ IXTA 20N65X	49	IXTH 20P50P	54	IXTN 90P20P	54	IXTP 120P065T	55
IXTA 24P085T	55	IXTH 22N50P	42	IXTN 110N20L2	52	IXTP 130N065T2	39
IXTA 26P10T	55	IXTH 26N60P	42	IXTN 120P20T	55	IXTP 130N10T	37
IXTA 26P20P	54	IXTH 26P20P	54	IXTN 170P10P	54	IXTP 140N055T2	39
IXTA 28P065T	55	IXTH 30N50L2	52	IXTN 200N10L2	52	IXTP 140P05T	55
IXTA 32P05T	55	IXTH 30N50P	42	IXTN 200N10T	37	IXTP 160N04T2	39
IXTA 32P20T	55	IXTH 30N60L2	52	IXTN 210P10T	55	IXTP 170N075T2	39

Alphanumeric Index

- New
- Not for new design
- ✦ Under development

IOTP 180N10T	37	IOTT 02N450HV	3, 51	IXXH 30N60B3	16	IXYH 50N65C3H1	17
IOTP 200N055T2	39	➤ IOTT 4N150HV	3, 51	IXXH 30N60B3D1	16	IXYH 50N120C3	20
IOTP 220N04T2	39	IOTT 6N120	51	➤ IXXH 30N60C3	16	IXYH 50N120C3D1	20
IOTP 230N075T2	39	IOTT 6N150	51	IXXH 30N60C3D1	16	➤ IXYH 60N90C3	19
IOTP 260N055T2	39	IOTT 10N100D2	53	IXXH 30N65B4	18	IXYH 75N65C3	17
IOTP 300N04T2	39	➤ IOTT 12N150HV	3, 51	IXXH 40N65B4	18	IXYH 75N65C3D1	17
IOTP 450P2	47	IOTT 16N10D2	53	➤ IXXH 40N65B4H1	18	IXYH 75N65C3H1	17
IOTP 460P2	47	IOTT 16N20D2	53	IXXH 50N60B3	16	➤ IXYH 80N90C3	19
IOTQ 10P50P	54	IOTT 16N50D2	53	IXXH 50N60B3D1	16	IXYH 82N120C3	20
IOTQ 14N60P	42	IOTT 16P60P	54	IXXH 50N60C3	16	IXYH 100N65B3	17
IOTQ 16N50P	42	IOTT 20P50P	54	IXXH 50N60C3D1	16	IXYH 100N65C3	17
IOTQ 18N60P	42	IOTT 26N50P	42	IXXH 60N65B4	18	IXYJ 20N120C3D1	3, 20
IOTQ 22N50P	42	IOTT 26N60P	42	IXXH 60N65B4H1	18	➤ IXYJ 30N120C3D1	3, 20
IOTQ 22N60P	42	IOTT 30N50L2	52	IXXH 60N65C4	18	IXYK 100N65B3D1	17
IOTQ 26N50P	42	IOTT 30N50P	42	IXXH 75N60B3	16	IXYK 100N65C3D1	17
IOTQ 26N60P	42	IOTT 30N60L2	52	IXXH 75N60B3D1	16	IXYK 100N120B3	20
IOTQ 26P20P	54	IOTT 30N60P	42	IXXH 75N60C3	16	IXYK 100N120C3	20
IOTQ 30N50L2	52	IOTT 36N50P	42	IXXH 75N60C3D1	16	IXYK 120N120C3	20, 20
IOTQ 30N50P	42	IOTT 40N50L2	52	IXXH 80N65B4	18	➤ IXYK 140N90C3	19
IOTQ 30N60L2	52	IOTT 48P20P	54	IXXH 80N65B4H1	18	➤ IXYL 60N450	24
IOTQ 30N60P	42	IOTT 52N30P	41	IXXH 100N60B3	16	➤ IXYN 75N65C3D1	17
➤ IOTQ 32N65X	49	IOTT 60N20L2	52	IXXH 100N60C3	16	➤ IXYN 80N90C3H1	19
IOTQ 32P20T	55	IOTT 64N25P	41	IXXH 110N65C4	18	IXYN 82N120C3	20
IOTQ 36N30P	41	IOTT 68P20T	55	IXXK 100N60B3H1	16	IXYN 82N120C3H1	20
IOTQ 36N50P	42	IOTT 69N30P	41	IXXK 100N60C3H1	16	IXYN 100N65A3	17
IOTQ 36P15P	54	IOTT 74N20P	41	IXXK 110N65B4H1	18	IXYN 100N65C3H1	17
IOTQ 40N50L2	52	IOTT 75N10L2	52	IXXK 160N65B4	18	IXYN 100N120B3H1	20
IOTQ 42N25P	41	IOTT 82N25P	41	IXXK 160N65C4	18	IXYN 100N120C3H1	20
IOTQ 44N50P	42	IOTT 88N30P	41	IXXK 200N60B3	16	➤ IXYN 120N120C3	20
IOTQ 44P15T	55	IOTT 90P10P	54	IXXK 200N60C3	16	IXYN1 00N120C3	20
IOTQ 48N20T	37	IOTT 96N15P	41	IXXK 200N65B4	18	➤ IXPY 8N90C3	19
IOTQ 50N20P	41	IOTT 96N20P	41	IXXK 300N60B3	16	➤ IXPY 8N90C3D1	19
IOTQ 50N25T	37	IOTT 100N25P	41	IXXK 300N60C3	16	IXYP 10N65C3	17
IOTQ 52N30P	41	IOTT 110N10L2	52	IXXN 100N60B3H1	16	IXYP 10N65C3D1	17
IOTQ 52P10P	54	IOTT 110N10P	41	IXXN 110N65B4H1	18	IXYP 10N65C3D1M	17
IOTQ 60N10T	37	IOTT 120N15P	41	IXXN 110N65C4H1	18	IXYP 15N65C3	17
IOTQ 60N20L2	52	IOTT 140N10P	41	IXXN 200N60B3	16	IXYP 15N65C3D1	17
IOTQ 60N20T	37	IOTT 140P10T	55	IXXN 200N60B3H1	16	IXYP 15N65C3D1M	17
IOTQ 62N15P	41	IOTT 170N10P	41	IXXN 200N60C3H1	16	IXYP 20N65C3D1	17
IOTQ 64N25P	41	IOTT 360N055T2	39	IXXP 50N60B3	16	IXYP 20N65C3D1M	17
IOTQ 69N30P	41	IOTT 440N055T2	39	➤ IXXQ 30N60B3M	16	IXYP 20N120C3	20
IOTQ 74N20P	41	IOTT 500N04T2	39	IXXR 100N60B3H1	16	IXYP 30N65C3	17
IOTQ 75N10P	41	IOTU 01N100	51	IXXR 110N65B4H1	18	IXYP 30N120C3	20
IOTQ 76N25T	37	IOTU 05N100	51	IXXX 100N60B3H1	16	IXYP 50N65C3	17
IOTQ 82N25P	41	IOTX 5N250	51	IXXX 100N60C3H1	16	IXYQ 30N65B3D1	17
IOTQ 86N20T	37	IOTX 24N100	51	IXXX 110N65B4H1	18	IXYQ 40N65B3D1	17
IOTQ 86N25T	37	IOTX 32P60P	54	IXXX 160N65B4	18	IXYQ 40N65C3D1	17
IOTQ 88N30P	41	IOTX 40P50P	54	IXXX 160N65C4	18	IXYR 50N120C3D1	20
IOTQ 96N15P	41	IOTX 60N50L2	52	IXXX 200N60B3	16	IXYR 100N120C3	20
IOTQ 96N20P	41	IOTX 90N25L2	52	IXXX 200N60C3	16	IXYT 20N120C3D1HV	3, 20
IOTQ 96N25T	37	IOTX 90P20P	54	IXXX 200N65B4	18	IXYT 30N65C3H1HV	3, 17
IOTQ 100N25P	41	➤ IOTX 102N65X2	49	IXXX 300N60B3	16	➤ IXYT 30N450HV	3, 24
IOTQ 102N20T	37	IOTX 110N20L2	52	IXXX 300N60C3	16	➤ IXYT 80N90C3	19
IOTQ 110N10P	41	IOTX 120P20T	55	➤ IXYA 8N90C3D1	19	➤ IXYX 40N450HV	1, 24
IOTQ 120N15P	41	IOTX 170P10P	54	IXYA 20N65C3	17	IXYX 100N65B3D1	17
IOTQ 120N20P	41	IOTX 200N10L2	52	➤ IXYA 20N120C3HV	2, 20	IXYX 100N65C3D1	17
IOTQ 130N10T	37	IOTX 210P10T	55	IXYA 50N65C3	17	IXYX 100N120B3	20
IOTQ 140N10P	41	IXTX 550N055T2	39	IXYB 82N120C3H1	20	IXYX 100N120C3	20
IOTQ 150N15P	41	IOTX 600N04T2	39	➤ IXYF 30N450	24	IXYX 120N120C3	20, 20
IOTQ 170N10P	41	IXTY 01N100	51	➤ IXYF 40N450	24	➤ IXYX 140N90C3	19
IOTQ 180N10T	37	IXTY 1N100P	42	IXYH 20N65C3	17	➤ IXYX 8N90C3	19
IOTQ 200N10T	37	IXTY 1R4N100P	42	IXYH 20N120C3	20	L	
IOTQ 450P2	47	IXTY 1R6N100D2	53	IXYH 20N120C3D1	20	LKK 47-06C5	56
IOTQ 460P2	47	IXTY 1R6N50D2	53	➤ IXYH 24N90C3	19	M	
IOTQ 470P2	47	➤ IXYT 2N65X2	49	➤ IXYH 24N90C3D1	19	➤ MCB 60I1200TZ	3, 49
IOTQ 480P2	47	IXTY 2N100P	42	IXYH 30N65B3D1	17	MCC 19-08io1B	81
IXTR 16P60P	54	IXTY 02N120P	42	IXYH 30N65C3	17	MCC 19-08io8B	81
IXTR 20P50P	54	➤ IXYT 4N65X2	49	IXYH 30N65C3H1	17	MCC 19-12io1B	81
IXTR 32P60P	54	IXTY 05N100	51	IXYH 30N120C3	20	MCC 19-12io8B	81
IXTR 36P15P	54	IXTY 08N50D2	53	IXYH 30N120C3D1	20	MCC 19-14io1B	81
IXTR 40P50P	54	➤ IXYT 8N65X2	49	➤ IXYH 30N450HV	24	MCC 19-14io8B	81
IXTR 48P20P	54	IXTY 08N100D2	53	IXYH 40N65B3	17	MCC 19-16io1B	81
IXTR 68P20T	55	IXTY 08N100P	42	IXYH 40N65B3D1	17	MCC 19-16io8B	81
IXTR 90P10P	54	IXTY 10P15T	55	IXYH 40N65C3	17	MCC 21-08io8B	81
IXTR 90P20P	54	IXTY 15P15T	55	IXYH 40N65C3D1	17	MCC 21-12io8B	81
IXTR 120P20T	55	IXTY 18P10T	55	IXYH 40N65C3H1	17	MCC 21-14io8B	81
IXTR 140P10T	55	IXTY 26P10T	55	➤ IXYH 40N90C3	19	MCC 21-16io8B	81
IXTR 170P10P	54	IXTY 32P05T	55	➤ IXYH 40N90C3D1	19	MCC 26-08io1B	81
IXTR 200N10P	41	IXTY 44N10T	37	IXYH 40N120B3	20	MCC 26-08io8B	81
IXTR 210P10T	55	IXTY 48P05T	55	IXYH 40N120B3D1	20	MCC 26-12io1B	81
IXTT 1N250HV	3, 51	IXTY 90N055T2	39	IXYH 40N120C3	20	MCC 26-12io8B	81
➤ IXTT 1N300P3HV	3, 51	IXTZ 550N055T2	39	IXYH 40N120C3D1	20	MCC 26-14io1B	81
IXTT 1N450HV	3, 51	IXXA 30N65C3HV	2, 16	IXYH 50N65C3	17	MCC 26-14io8B	81
IXTT 2N170D2	53	IXXA 50N60B3	16	IXYH 50N65C3D1	17	MCC 26-16io1B	81

Alphanumeric Index

- > New
- Not for new design
- ◇ Under development

MCC 26-16io8B	81	MCC 310-18io1	83	MCD 250-14io1	80	MCNA 120P2200TA	82
MCC 44-08io1B	81	MCC 312-12io1	83	MCD 250-16io1	80	MCNA 120PD2200TB	79
MCC 44-08io8B	81	MCC 312-14io1	83	MCD 250-18io1	80	MCNA 120UI2200TED	92
MCC 44-12io1B	81	MCC 312-16io1	83	MCD 255-12io1	80	> MCNA 650P2200CA	83
MCC 44-12io8B	81	MCC 312-18io1	83	MCD 255-14io1	80	> MCNA 650PD2200CB	80
MCC 44-14io1B	81	MCD 26-08io1B	78	MCD 255-16io1	80	MCO 25-12io1	84
MCC 44-14io8B	81	MCD 26-08io8B	78	MCD 255-18io1	80	MCO 25-16io1	84
MCC 44-16io1B	81	MCD 26-12io1B	78	MCD 310-08io1	80	MCO 50-12io1	84
MCC 44-16io8B	81	MCD 26-12io8B	78	MCD 310-12io1	80	MCO 50-16io1	84
MCC 44-18io1B	81	MCD 26-14io1B	78	MCD 310-14io1	80	MCO 75-12io1	84
MCC 44-18io8B	81	MCD 26-14io8B	78	MCD 310-16io1	80	MCO 75-16io1	84
MCC 56-08io1B	81	MCD 26-16io1B	78	MCD 310-18io1	80	MCO 100-12io1	84
MCC 56-08io8B	81	MCD 26-16io8B	78	MCD 310-20io1	80	MCO 100-16io1	84
MCC 56-12io1B	81	MCD 40-12io6	78	MCD 310-22io1	80	MCO 150-12io1	84
MCC 56-12io8B	81	MCD 40-16io6	78	MCD 312-12io1	80	MCO 150-16io1	84
MCC 56-14io1B	81	MCD 44-08io1B	78	MCD 312-14io1	80	MCO 450-20io1	84
MCC 56-14io8B	81	MCD 44-08io8B	78	MCD 312-16io1	80	MCO 450-22io1	84
MCC 56-16io1B	81	MCD 44-12io1B	78	MCD 312-18io1	80	MCO 500-12io1	84
MCC 56-16io8B	81	MCD 44-12io8B	78	MCK 200-18io1	83	MCO 500-14io1	84
MCC 56-18io1B	81	MCD 44-14io1B	78	MCMA 25P1200TA	81	MCO 500-16io1	84
MCC 56-18io8B	81	MCD 44-14io8B	78	MCMA 25P1600TA	81	MCO 500-18io1	84
MCC 72-08io1B	82	MCD 44-16io1B	78	MCMA 25PD1200TB	78	MCO 600-16io1	84
MCC 72-08io8B	82	MCD 44-16io8B	78	MCMA 25PD1600TB	78	MCO 600-18io1	84
MCC 72-12io1B	82	MCD 44-18io1B	78	MCMA 35P1200TA	81	MCO 600-20io1	84
MCC 72-12io8B	82	MCD 44-18io8B	78	MCMA 35P1600TA	81	MCO 600-22io1	84
MCC 72-14io1B	82	MCD 56-08io1B	78	MCMA 35PD1200TB	78	MDA 95-22N1B	76
MCC 72-14io8B	82	MCD 56-08io8B	78	MCMA 35PD1600TB	78	MDD 26-08N1B	75
MCC 72-16io1B	82	MCD 56-12io1B	78	MCMA 50P1200TA	81	MDD 26-12N1B	75
MCC 72-16io8B	82	MCD 56-12io8B	78	MCMA 50P1600TA	81	MDD 26-14N1B	75
MCC 72-18io1B	82	MCD 56-14io1B	78	MCMA 50PD1200TB	78	MDD 26-16N1B	75
MCC 72-18io8B	82	MCD 56-14io8B	78	MCMA 50PD1600TB	78	MDD 26-18N1B	75
MCC 94-20io1B	82	MCD 56-16io1B	78	MCMA 65P1200TA	82	MDD 44-08N1B	75
MCC 94-22io1B	82	MCD 56-16io8B	78	MCMA 65P1600TA	82	MDD 44-12N1B	75
MCC 94-24io1B	82	MCD 56-18io1B	78	> MCMA 65P1800TA	82	MDD 44-14N1B	75
MCC 95-08io1B	82	MCD 56-18io8B	78	MCMA 65PD1200TB	78	MDD 44-16N1B	75
MCC 95-08io8B	82	MCD 72-08io1B	79	MCMA 65PD1600TB	78	MDD 44-18N1B	75
MCC 95-12io1B	82	MCD 72-08io8B	79	> MCMA 65PD1800TB	78	MDD 56-08N1B	75
MCC 95-12io8B	82	MCD 72-12io1B	79	MCMA 85P1200TA	82	MDD 56-12N1B	75
MCC 95-14io1B	82	MCD 72-12io8B	79	MCMA 85P1600TA	82	MDD 56-14N1B	75
MCC 95-14io8B	82	MCD 72-14io1B	79	> MCMA 85P1800TA	82	MDD 56-16N1B	75
MCC 95-16io1B	82	MCD 72-14io8B	79	MCMA 85PD1200TB	79	MDD 56-18N1B	75
MCC 95-16io8B	82	MCD 72-16io1B	79	MCMA 85PD1600TB	79	MDD 72-08N1B	75
MCC 95-18io1B	82	MCD 72-16io8B	79	> MCMA 85PD1800TB	79	MDD 72-12N1B	75
MCC 95-18io8B	82	MCD 72-18io1B	79	MCMA 110P1200TA	82	MDD 72-14N1B	75
MCC 132-08io1	82	MCD 72-18io8B	79	MCMA 110P1600TA	82	MDD 72-16N1B	75
MCC 132-12io1	82	MCD 94-20io1B	79	> MCMA 110P1800TA	82	MDD 72-18N1B	75
MCC 132-14io1	82	MCD 94-22io1B	79	MCMA 110PD1200TB	79	MDD 95-08N1B	76
MCC 132-16io1	82	MCD 95-08io1B	79	MCMA 110PD1600TB	79	MDD 95-12N1B	76
MCC 132-18io1	82	MCD 95-08io8B	79	> MCMA 110PD1800TB	79	MDD 95-14N1B	76
MCC 161-20io1	82	MCD 95-12io1B	79	MCMA 120UI1800ED	93	MDD 95-16N1B	76
MCC 161-22io1	82	MCD 95-12io8B	79	MCMA 140P1200TA	82	MDD 95-18N1B	76
MCC 162-08io1	82	MCD 95-14io1B	79	MCMA 140P1400TA	82	MDD 95-20N1B	76
MCC 162-12io1	82	MCD 95-14io8B	79	MCMA 140P1600TA	82	MDD 95-22N1B	76
MCC 162-14io1	82	MCD 95-16io1B	79	MCMA 140P1800TA	82	MDD 142-08N1	76
MCC 162-16io1	82	MCD 95-16io8B	79	MCMA 140PD1200TB	79	MDD 142-12N1	76
MCC 162-18io1	82	MCD 95-18io1B	79	MCMA 140PD1600TB	79	MDD 142-14N1	76
MCC 200-14io1	83	MCD 95-18io8B	79	> MCMA 140PD1800TB	79	MDD 142-16N1	76
MCC 200-16io1	83	MCD 132-08io1	79	MCMA 200P1600SA	83	MDD 142-18N1	76
MCC 200-18io1	83	MCD 132-12io1	79	MCMA 200PD1600SA	80	MDD 172-08N1	76
MCC 220-08io1	83	MCD 132-14io1	79	MCMA 240UI1600ED	92	MDD 172-12N1	76
MCC 220-12io1	83	MCD 132-16io1	79	MCMA 240UI1600PED	1, 92	MDD 172-14N1	76
MCC 220-14io1	83	MCD 132-18io1	79	MCMA 260P1600YA	83	MDD 172-16N1	76
MCC 220-16io1	83	MCD 161-20io1	79	> MCMA 260P1800YA	83	MDD 172-18N1	76
MCC 220-18io1	83	MCD 161-22io1	79	MCMA 260PD1600YB	80	MDD 175-28N1	76
MCC 224-20io1	83	MCD 162-08io1	80	> MCMA 260PD1800YB	80	MDD 175-34N1	76
MCC 224-22io1	83	MCD 162-12io1	80	MCMA 265P1600KA	83	MDD 200-14N1	76
MCC 224-24io1	83	MCD 162-14io1	80	> MCMA 265P1800KA	83	MDD 200-16N1	76
MCC 225-12io1	83	MCD 162-16io1	80	MCMA 265PD1600KB	80	MDD 200-18N1	76
MCC 225-14io1	83	MCD 162-18io1	80	> MCMA 265PD1800KB	80	MDD 200-22N1	76
MCC 225-16io1	83	MCD 200-14io1	80	> MCMA 650MT1800NKD	94	MDD 220-08N1	76
MCC 225-18io1	83	MCD 200-16io1	80	MCMA 700P1600CA	83	MDD 220-12N1	76
MCC 250-08io1	83	MCD 200-18io1	80	> MCMA 700P1600NCA	83	MDD 220-14N1	76
MCC 250-12io1	83	MCD 220-08io1	80	> MCMA 700P1800CA	83	MDD 220-16N1	76
MCC 250-14io1	83	MCD 220-12io1	80	> MCMA 700P1800NCA	83	MDD 220-18N1	76
MCC 250-16io1	83	MCD 220-14io1	80	MCMA 700PD1600CB	80	MDD 250-08N1	76
MCC 250-18io1	83	MCD 220-16io1	80	> MCMA 700PD1800CB	80	MDD 250-12N1	76
MCC 255-12io1	83	MCD 224-20io1	80	MCNA 40P2200TA	81	MDD 250-14N1	76
MCC 255-14io1	83	MCD 224-22io1	80	> MCNA 40PD2200TB	78	MDD 250-16N1	76
MCC 255-16io1	83	MCD 225-12io1	80	> MCNA 55P2200TA	82	MDD 255-12N1	77
MCC 255-18io1	83	MCD 225-14io1	80	> MCNA 55PD2200TB	78	MDD 255-14N1	77
MCC 310-08io1	83	MCD 225-16io1	80	> MCNA 75P2200TA	82	MDD 255-16N1	77
MCC 310-12io1	83	MCD 225-18io1	80	> MCNA 75PD2200TB	79	MDD 255-18N1	77
MCC 310-14io1	83	MCD 250-08io1	80	> MCNA 95P2200TA	82	MDD 255-20N1	77
MCC 310-16io1	83	MCD 250-12io1	80	> MCNA 95PD2200TB	79	MDD 255-22N1	77

Alphanumeric Index

- New
- Not for new design
- ✦ Under development

MDD 310-08N1	77	MEK 150-04DA	68	✦ MIXG 300PF1700TSF	32	MUBW 15-06A6K	27
MDD 310-12N1	77	MEK 250-12DA	68	➤ MIXG 330PF1200TSF	32	○ MUBW 15-06A7	27
MDD 310-14N1	77	MEK 300-06DA	68	✦ MIXG 450PF1200TLP	34	MUBW 15-12A6K	27
MDD 310-16N1	77	MEK 350-02DA	68	✦ MIXG 450PF1700TSF	32	MUBW 15-12A7	27
MDD 310-18N1	77	MEK 600-04DA	68	➤ MIXG 490PF1200TSF	32	○ MUBW 15-12T7	27
MDD 310-20N1	77	MEO 450-12DA	68	MKE 11R600DCGFC	12, 56, 58	MUBW 20-06A6K	27
MDD 310-22N1	77	MEO 500-06DA	68	MKE 38P600LB	7	MUBW 20-06A7	27
MDD 312-12N1	77	MEO 550-02DA	68	MKE 38RK600DFELB	7, 58	○ MUBW 25-06A6K	27
MDD 312-14N1	77	MID 75-12A3	34	✦ MKG 17RK600DCGLB	58	MUBW 25-12A7	27
MDD 312-16N1	77	MID 100-12A3	34	➤ MKG 40RK600LB	7, 58	MUBW 30-06A7	27
MDD 312-18N1	77	MID 145-12A3	34	✦ MKH 17RP650DCGLB	7	MUBW 30-12A6K	27
MDD 312-20N1	77	○ MID 150-12A4	34	✦ MKH 22P650LB	7	MUBW 35-06A6K	27
MDD 312-22N1	77	MID 200-12A4	34	➤ MKH 24I650HR	3, 56	MUBW 35-12A7	27
MDI 75-12A3	34	MID 300-12A4	34	✦ MKH 40P650LB	7	○ MUBW 35-12A8	28
MDI 100-12A3	34	MID 550-12A4	34	○ MKI 50-06A7	33	MUBW 45-12T6K	27
MDI 145-12A3	34	MIEB 100W1200DPFTEH	30	○ MKI 50-06A7T	33	MUBW 50-06A7	27
○ MDI 150-12A4	34	○ MIEB 101H1200EH	33	○ MKI 50-12F7	33	○ MUBW 50-06A8	28
MDI 200-12A4	34	MIEB 101W1200DPFEH	30	○ MKI 65-06A7T	33	MUBW 50-12A8	28
MDI 300-12A4	34	MIEB 101W1200EH	30	○ MKI 75-06A7	33	MUBW 50-12T8	28
MDI 550-12A4	34	MII 75-12A3	34	MKI 75-06A7T	33	MUBW 50-17T8	28
MDMA 25P1200TG	75	MII 100-12A3	34	○ MKI 80-06T6K	33	MUBW 75-06A8	28
MDMA 25P1600TG	75	MII 145-12A3	34	MKI 100-12F8	33	MUBW 75-12T8	28
➤ MDMA 25P1800TG	75	MII 150-12A4	34	➤ MMIX 1B15N300C	8	MUBW 75-17T8	28
MDMA 35P1200TG	75	MII 200-12A4	34	➤ MMIX 1B20N300C	8	○ MUBW 100-06A8	28
MDMA 35P1600TG	75	MII 300-12A4	34	MMIX 1F40N110P	7	○ MWI 15-12A7	29
➤ MDMA 35P1800TG	75	➤ MITA 150H1700TEH	33	MMIX 1F44N100Q3	7	○ MWI 25-12A7	29
MDMA 50P1200TG	75	○ MIXA 10W1200TML	29	MMIX 1F132N50P3	7	○ MWI 25-12A7T	29
MDMA 50P1600TG	75	MIXA 10WB1200TED	27	MMIX 1F160N30T	7	○ MWI 30-06A7	29
➤ MDMA 50P1800TG	75	MIXA 10WB1200TML	27	MMIX 1F180N25T	7	MWI 30-06A7T	29
MDMA 60UC1600VC	93	○ MIXA 20W1200TML	29	MMIX 1F210N30P3	7	MWI 35-12T7T	29
MDMA 65P1200TG	75	MIXA 20WB1200TED	27	MMIX 1F230N20T	7	○ MWI 50-06A7	29
MDMA 65P1600TG	75	MIXA 20WB1200TMI	31	MMIX 1F360N15T2	7	○ MWI 50-06A7T	29
➤ MDMA 65P1800TG	75	MIXA 20WB1200TML	27	MMIX 1F420N10T	7	○ MWI 50-12A7	29
MDMA 85P1200TG	75	MIXA 30W1200TED	29	MMIX 1F520N075T2	7, 40	○ MWI 50-12A7T	29
MDMA 85P1600TG	75	○ MIXA 30W1200TML	29	MMIX 1G75N250	8	MWI 50-12T7T	29
➤ MDMA 85P1800TG	75	MIXA 30WB1200TED	27	MMIX 1G120N120A3V1	8	MWI 60-12T6K	29
MDMA 110P1200TG	76	MIXA 30WB1200TMI	31	➤ MMIX 1H60N150V1	9	○ MWI 75-06A7	29
MDMA 110P1600TG	76	MIXA 40W1200TED	29	MMIX 1T550N055T2	7, 40	MWI 75-06A7T	29
➤ MDMA 110P1800TG	76	✦ MIXA 40W1200TMI	31	MMIX 1T600N04T2	7, 40	○ MWI 75-12A8	30
MDMA 140P1200TG	76	○ MIXA 40W1200TML	29	MMIX 1Y82N120C3H1	8	MWI 75-12T7T	29
MDMA 140P1600TG	76	MIXA 40WB1200TED	27	MMIX 1Y100N120C3H1	8	○ MWI 75-12T8T	30
MDMA 140P1800TG	76	MIXA 50PM650TMI	31	➤ MMIX 2F60N50P3	7	MWI 80-12T6K	29
MDMA 200P1600SA	76	➤ MIXA 50W650TED	29	➤ MMIX 2F94N30T	7	MWI 100-06A8	30
MDMA 210UB1600PTED	1, 92	➤ MIXA 50WB600TED	27	➤ MMIX 2F150N20T	7	○ MWI 100-12A8	30
MDMA 240UB1600ED	92	MIXA 60HU1200VA	34	➤ MMIX 4B22N300	8	MWI 150-06A8	30
MDMA 280UB1600PTED	1, 92	MIXA 60W1200TED	29	MMIX 4G20N250	8	○ MWI 150-12T8T	30
MDMA 360UB1600PTED	1, 92	✦ MIXA 60W1200TMI	31	MMIX 1X100N60B3H1	8	○ MUBW 200-06A8	30
MDMA 380P1600KC	77	MIXA 60WB1200TEH	28	MMIX 1X200N60B3	8	U	
➤ MDMA 380P1800KC	77	MIXA 60WH1200TEH	28	MMIX 1X200N60B3H1	8	UGB 3132AD	95
MDMA 660U1600PTEH	1, 91	MIXA 61H1200ED	33	➤ MMIX 1X340N65B4	8	UGB 6124AG	95
MDMA 700P1600CC	77	➤ MIXA 75W650TED	29	➤ MMJX 1H40N150	9	UGD 6123AG	95
➤ MDMA 700P1800CC	77	MIXA 80R1200VA	34	MMO 62-12io6	94	UGD 8124AG	95
MDMA 900U1600PTEH	1, 91	MIXA 80W1200TED	29	MMO 62-16io6	94	UGE 0221AY4	95
➤ MDNA 25P2200TG	75	MIXA 80W1200TEH	30	MMO 74-12io6	94	UGE 0421AY4	95
➤ MDNA 35P2200TG	75	MIXA 80WB1200TEH	28	MMO 74-16io6	94	UGE 1112AY4	95
➤ MDNA 50P2200TG	75	MIXA 81H1200EH	33	MMO 90-12io6	94	UGE 3126AY4	95
➤ MDNA 65P2200TG	75	MIXA 81WB1200TEH	28	MMO 90-14io6	94	V	
➤ MDNA 85P2200TG	75	✦ MIXA 100PF650YI	34	MMO 90-16io6	94	VBE 17-06NO7	86
➤ MDNA 110P2200TG	76	MIXA 100PM650TMI	31	MMO 110-08io7	94	VBE 17-12NO7	86
MDNA 140P2200TG	76	MIXA 100W1200TEH	30	MMO 110-12io7	94	VBE 20-20NO1	86
➤ MDNA 210UB2200PTED	92	MIXA 150Q1200VA	34	MMO 110-14io7	94	VBE 26-06NO7	86
➤ MDNA 240U2200ED	91	MIXA 150R1200VA	34	MMO 140-08io7	94	VBE 26-12NO7	86
➤ MDNA 280UB2200PTED	92	MIXA 150W1200TEH	30	MMO 140-12io7	94	VBE 55-06NO7	86
➤ MDNA 360UB2200PTED	92	MIXA 225PF1200TSF	32	MMO 140-16io7	94	VBE 55-12NO7	86
➤ MDNA 380P2200KC	77	MIXA 225RF1200TSF	32	MMO 175-08io7	94	VBE 60-06A	86
MDNA 660U2200PTEH	1, 91	✦ MIXA 300PF1200TLP	34	MMO 175-12io7	94	VBE 60-12A	86
➤ MDNA 700P2200CC	77	MIXA 300PF1200TSF	32	MMO 175-16io7	94	VBE 100-06NO7	86
MDO 500-12N1	77	✦ MIXA 430LD1200TSF	32	MMO 230-08io7	94	VBE 100-12NO7	86
MDO 500-14N1	77	MIXA 450PF1200TSF	32	MMO 230-12io7	94	VBO 13-08NO2	87
MDO 500-16N1	77	✦ MIXA 600AF650TSF	32	MMO 230-14io7	94	VBO 13-12AO2	87
MDO 500-18N1	77	✦ MIXA 600CF650TSF	32	MMO 230-16io7	94	VBO 13-12NO2	87
MDO 500-20N1	77	MIXA 600PF650TSF	32	MMO 230-18io7	94	VBO 13-16AO2	87
MDO 500-22N1	77	MIXB 52HR600DCGED	33	MPK 95-06DA	68	VBO 13-16NO2	87
MDO 600-16N1	77	MIXB 52HR600ED	33	➤ MTC 120W55GC	10	VBO 20-08NO2	87
MEA 75-12DA	68	✦ MIXD 80PM650TMI	31	➤ MTC 120WX55GD	10	VBO 20-12AO2	87
MEA 95-06DA	68	✦ MIXD 200W650TEH	30	➤ MTC 120WX75GD	10	VBO 20-12NO2	87
MEA 250-12DA	68	✦ MIXG 85W1200TED	29	✦ MTC 840X75TGD	10	VBO 20-16AO2	87
MEA 300-06DA	68	✦ MIXG 85WB1200TEH	28	✦ MTC 960X55TGD	10	VBO 20-16NO2	87
MEE 75-12DA	68	MIXG 120W1200PTEH	1	MTI 85W100GC	10	VBO 21-08NO7	87
MEE 95-06DA	68	✦ MIXG 120W1200TEH	30	MTI 145WX100GD	10	VBO 21-12NO7	87
MEE 250-12DA	68	MIXG 180W1200PTEH	1	MTI 200WX75GD	10	VBO 22-08NO8	87
MEE 300-06DA	68	✦ MIXG 180W1200TEH	30	MUBW 10-06A6K	27	VBO 22-12NO8	87
MEK 75-12DA	68	✦ MIXG 200PF1200YI	34	○ MUBW 10-06A7	27	VBO 22-16NO8	87
MEK 95-06DA	68	✦ MIXG 300PF1700TLP	34	○ MUBW 10-12A7	27	VBO 22-18NO8	87

Alphanumeric Index

> New
 ○ Not for new design
 ◇ Under development

VBO 25-08NO2	87	VHFD 16-16io1	88	VUO 52-18NO1	89	VW 2x60-12io1	94
VBO 25-12AO2	87	VHFD 29-08io1	88	VUO 52-20NO1	89	VW 2x60-14io1	94
VBO 25-12NO2	87	VHFD 29-12io1	88	VUO 52-22NO1	89	VW 2x60-16io1	94
VBO 25-16AO2	87	VHFD 29-16io1	88	VUO 55-12NO7	90	VVO 35-08ho7	94
VBO 25-16NO2	87	VHFD 37-08io1	88	VUO 55-14NO7	90	VVO 35-12ho7	94
VBO 30-08NO7	87	VHFD 37-12io1	88	VUO 55-16NO7	90		
VBO 30-12NO7	87	VHFD 37-16io1	88	VUO 55-18NO7	90		
VBO 30-16NO7	87	VKM 40-06P1	57	VUO 60-12NO3	90		
VBO 30-18NO7	87	VMM 90-09F	57	VUO 60-14NO3	90		
VBO 36-08NO8	87	○ VMO 550-01F	57	VUO 60-16NO3	90		
VBO 36-12NO8	87	○ VMO 580-02F	57	VUO 60-18NO3	90		
VBO 36-16NO8	87	○ VMO 650-01F	57	VUO 62-08NO7	90		
VBO 36-18NO8	87	VMO 1200-01F	57	VUO 62-12NO7	90		
VBO 40-08NO6	87	VTO 39-08ho7	93	VUO 62-14NO7	90		
VBO 40-12NO6	87	VTO 39-12ho7	93	VUO 62-16NO7	90		
VBO 40-16NO6	87	VUB 72-12NOXT	92	VUO 62-18NO7	90		
VBO 50-08NO7	87	VUB 72-16NOXT	92	VUO 64-16NO7	90		
VBO 50-12NO7	87	VUB 116-16NOXT	92	VUO 68-08NO7	90		
VBO 50-16NO7	87	VUB 120-16NOX	92	VUO 68-12NO7	90		
VBO 50-18NO7	87	VUB 120-16NOXT	92	VUO 68-14NO7	90		
VBO 52-08NO7	87	VUB 135-22NO1	92	VUO 68-16NO7	90		
VBO 52-12NO7	87	VUB 145-16NOXT	92	○ VUO 70-16NO7	90		
VBO 52-16NO7	87	VUB 160-16NOX	92	VUO 80-08NO1	90		
VBO 52-18NO7	87	VUB 160-16NOXT	92	VUO 80-12NO1	90		
VBO 54-08NO7	87	VUC 36-12go2	93	VUO 80-14NO1	90		
VBO 54-12NO7	87	VUC 36-16go2	93	VUO 80-16NO1	90		
VBO 54-16NO7	87	VUE 22-06NO7	86	VUO 80-18NO1	90		
VBO 68-08NO7	87	VUE 22-12NO7	86	VUO 82-08NO7	90		
VBO 68-12NO7	87	VUE 30-20NO1	86	VUO 82-12NO7	90		
VBO 68-16NO7	87	VUE 35-06NO7	86	VUO 82-14NO7	90		
VBO 72-08NO7	87	VUE 35-12NO7	86	VUO 82-16NO7	90		
VBO 72-12NO7	87	VUE 50-12NO1	86	VUO 82-18NO7	90		
VBO 72-16NO7	87	VUE 75-06NO7	86	VUO 84-16NO7	90		
VBO 72-18NO7	87	VUE 75-12NO7	86	VUO 86-08NO7	90		
VBO 78-08NO7	88	VUE 130-06NO7	86	VUO 86-12NO7	90		
VBO 78-12NO7	88	VUE 130-12NO7	86	VUO 86-14NO7	90		
VBO 78-16NO7	88	VUI 30-12N1	58	VUO 86-16NO7	90		
VBO 88-08NO7	88	VUI 72-16NOXT	92	VUO 98-08NO7	90		
VBO 88-12NO7	88	○ VUM 24-05N	58	VUO 98-12NO7	90		
VBO 88-16NO7	88	VUM 25-05E	58	VUO 98-14NO7	90		
VBO 105-08NO7	88	○ VUM 33-05N	58	VUO 98-16NO7	90		
VBO 105-12NO7	88	VUM 33-06PH	58	VUO 105-12NO7	90		
VBO 105-16NO7	88	VUM 85-05A	58	VUO 105-14NO7	90		
VBO 125-08NO7	88	VUO 22-08NO1	89	VUO 105-16NO7	90		
VBO 125-12NO7	88	VUO 22-12NO1	89	VUO 105-18NO7	90		
VBO 125-16NO7	88	VUO 22-14NO1	89	VUO 110-08NO7	91		
VBO 130-08NO7	88	VUO 22-16NO1	89	VUO 110-12NO7	91		
VBO 130-12NO7	88	VUO 22-18NO1	89	VUO 110-14NO7	91		
VBO 130-16NO7	88	VUO 25-08NO8	89	VUO 110-16NO7	91		
VBO 130-18NO7	88	VUO 25-12NO8	89	VUO 110-18NO7	91		
VBO 160-08NO7	88	VUO 25-14NO8	89	VUO 120-12NO2T	91		
VBO 160-12NO7	88	VUO 25-16NO8	89	VUO 120-16NO2T	91		
VBO 160-16NO7	88	VUO 25-18NO8	89	VUO 121-16NO1	91		
VBO 160-18NO7	88	VUO 28-08NO7	89	VUO 122-08NO7	91		
VCO 132-08io7	84	VUO 28-12NO7	89	VUO 122-12NO7	91		
VCO 132-12io7	84	VUO 30-08NO3	89	VUO 122-14NO7	91		
VCO 132-14io7	84	VUO 30-12NO3	89	VUO 122-16NO7	91		
VCO 132-16io7	84	VUO 30-14NO3	89	VUO 125-12NO7	91		
VCO 132-18io7	84	VUO 30-16NO3	89	VUO 125-14NO7	91		
VCO 180-08io7	84	VUO 30-18NO3	89	VUO 125-16NO7	91		
VCO 180-12io7	84	VUO 34-08NO1	89	VUO 125-18NO7	91		
VCO 180-14io7	84	VUO 34-12NO1	89	VUO 160-08NO7	91		
VCO 180-16io7	84	VUO 34-14NO1	89	VUO 160-12NO7	91		
VCO 180-18io7	84	VUO 34-16NO1	89	VUO 160-14NO7	91		
VGB 0124AY7a	95	VUO 34-18NO1	89	VUO 160-16NO7	91		
VGf 0136AB	95	VUO 35-08NO7	89	VUO 160-18NO7	91		
VGf 0136AH	95	VUO 35-12NO7	89	VUO 162-16NO7	91		
VGO 36-16io7	88	VUO 35-14NO7	89	VUO 190-08NO7	91		
VHF 15-08io5	88	VUO 35-16NO7	89	VUO 190-12NO7	91		
VHF 15-12io5	88	VUO 35-18NO7	89	VUO 190-14NO7	91		
VHF 15-14io5	88	VUO 36-08NO8	89	VUO 190-16NO7	91		
VHF 15-16io5	88	VUO 36-12NO8	89	VUO 190-18NO7	91		
VHF 25-08io7	88	VUO 36-14NO8	89	VUO 192-16NO7	91		
VHF 25-12io7	88	VUO 36-16NO8	89	VVZ 39-08ho7	93		
VHF 28-08io5	88	VUO 36-18NO8	89	VVZ 39-12ho7	93		
VHF 28-12io5	88	VUO 50-08NO3	89	VVZ 40-12io1	93		
VHF 28-14io5	88	VUO 50-12NO3	89	VVZ 40-16io1	93		
VHF 28-16io5	88	VUO 50-14NO3	89	VVZ 110-12io7	93		
VHF 36-08io5	88	VUO 50-16NO3	89	VVZ 175-12io7	93		
VHF 36-12io5	88	VUO 50-18NO3	89	VVZ 175-16io7	93		
VHF 36-14io5	88	VUO 52-08NO1	89	VVZB 120-16ioX	92		
VHF 36-16io5	88	VUO 52-12NO1	89	VVZB 135-16ioXT	92		
VHFD 16-08io1	88	VUO 52-14NO1	89	VVZB 170-16ioXT	92		
VHFD 16-12io1	88	VUO 52-16NO1	89	○ VVZF 70-16io7	93		

IXYS ICD

C

CPC1580	105
CPC1590	105
CPC1706Y	99
CPC1708J	99
CPC1709J	99
CPC1718J	99
CPC1726Y	99
CPC1727J	99
CPC1777J	99
CPC1779J	99
CPC1786J	99
CPC1788J	99
CPC1906Y	99
> CPC1907B	99
CPC1908J	99
CPC1909J	99
CPC1916Y	99
CPC1918J	99
CPC1926Y	99
CPC1927J	99
CPC1943	100
CPC1945G	100
CPC1945Y	100
CPC1961	100
CPC1963	100
> CPC1964B	100
> CPC1964BX6	100
> CPC1964G	100
> CPC1964Y	100
CPC1965G	100
CPC1965Y	100
CPC1966	100
CPC1966B	100
> CPC1966YX6	100
CPC1967J	99
> CPC1968J	99
CPC1972	100
CPC1973Y	99
CPC1976	100
> CPC1976YX6	100
CPC1977J	99
CPC1978J	99
CPC1979J	99
CPC1981Y	99
> CPC1983B	99
CPC1983Y	99
> CPC1983YE	99
CPC1986J	99
CPC1988J	99
CPC1998J	100
CPC3701	106
CPC3703	106
CPC3708	106
CPC3710	106
CPC3714	106
CPC3720	106
CPC3730	106
CPC3902	106
CPC3909	106
CPC3960	106
CPC3980	106
CPC3982	106
> CPC40055ST	100
> CPC44055ST	100
CPC5602	106
CPC5603	106

F

FDA215	105
FDA217	105

I

IX2113	102
IX2127	103
IX21844	102
IX2204	103

Alphanumeric Index

- New
- Not for new design
- ✦ Under development

IX3120	104	E1500NH48P	117	F0240YH250	116	K2065VC360	124
IX3180	104	➤ E2060FF65F	117	F0240YH300	116	K2065VC420	124
➤ IX4423	101	E2250VF20C	117	F0300WC140	116	K2065VF360	124
➤ IX4424	101	E2250VF25C	117	F0300WC180	116	K2065VF420	124
➤ IX4425	101	E2400TC40C	117	F0800LC140	116	➤ K2085TE600	124
➤ IX4426	101	E2400TC45C	117	F0800LC180	116	➤ K2085TE650	124
➤ IX4427	101	E4000TC20C	117	F0900VC450	116	K2095ZC360	124
➤ IX4428	101	E4000TC25C	117	F0900VC520	116	K2095ZC420	124
IXD_602 family	101	E50.N15-254N5W	158	F0900VF450	116	K2095ZD360	124
IXD_604 family	101	E50.N15-293NTW	158	F0900VF520	116	K2095ZD420	124
IXD_609 family	101	E50.N15-304NTW	158	F1000LC080	116	➤ K2325TJ600	124
IXD_614 family	101	E50.N15-603NTW	158	F1000LC120	116	➤ K2325TJ650	124
IXD_630 family	101	E50.N23-104NTW	158	F1300NC45P	116	K2359TC600	124
IXD_630M family	101	E50.N23-503NTW	158	F1300NC50P	116	K2359TC650	124
LOC110	106	E50.N25-564NTW	158	F1300NC55P	116	K2359TD600	124
LOC111	106	E50.R16-114NTW	158	F1300NH45P	116	K2359TD650	124
LOC112	106	E50.R16-554NTW	158	F1300NH50P	116	K2960TC450	124
LOC117	106	E50.R16-573NTW	158	F1300NH55P	116	K2960TC480	124
LOC210	106	E50.R23-174NTW	158	F1400NC140	116	K2960TC520	124
LOC211	106	E50.R23-824NTW	158	F1400NC180	116	K2960TD450	124
PD1201	100	E50.R23-863NTW	158	F1400ND140	116	K2960TD480	124
PD2401	100	E50.R29-114NTW	158	F1400ND180	116	K2960TD520	124
PD2601	100	E50.R29-115NTW	158	F1500NC200	116	K2973FC600	124
PM1204	100	E50.R29-224NTW	158	F1500NC250	116	K2973FC650	124
PM1205	100	E50.R34-144NTW	158	F1600NC080	116	K2973FD600	124
PM1206	100	E50.R34-145NTW	158	F1600NC120	116	K2973FD650	124
PS1201	100	E50.R34-284NTW	158	G		K3362TC360	124
PS2401	100	E50.S29-164NTW	158	G1000NC450	133	K3362TC420	124
PS2601	100	E50.S29-165NTW	158	G1000QC250	133	K3362TD360	124
		E50.S29-314NTW	158	G1000QC450	133	K3362TD420	124
		E50.S34-205NTW	158	G2000HF250	133	K3503FC450	124
		E50.S34-394NTW	158	G2000HF450	133	K3503FC480	124
		E53.H59-102T1W	157	G2500HF250	133	K3503FC520	124
		E53.H59-123T1W	157	G3000TF250	133	K3503FD450	124
		E53.H59-152T1W	157	G3000TF450	133	K3503FD480	124
		E53.H59-153T1W	157	➤ G4000EF450	133	K3503FD520	124
		E53.H59-252T1W	157	H		L	
		E53.H59-303T1W	157	H0500KC200	133	L0001HC600XXX	148
		E53.H59-332T1W	157	H0500KC20Y	133	L0001NC600XXX	148
		E53.H59-333T1W	157	H0500KC25D	133	L0001QC600XXX	148
		E53.H59-471T1W	157	H0500KC25Y	133	L0001TC600XXX	148
		E53.H59-472T1W	157	H0700KC140	133	L0001YC600XXX	148
		E53.H59-503T1W	157	H0700KC14Y	133	L0001ZF600XXX	148
		E53.H59-802T1W	157	H0700KC17D	133	M	
		E53.M59-103T2W	157	H0700KC17Y	133	M0130RL200	113
		E53.M59-163T2W	157	H1200NC200	133	M0130RL250	113
		E53.M59-252T2W	157	H1200NC20Y	133	M0130RM200	113
		E53.M59-253T2W	157	H1200NC25D	133	M0130RM250	113
		E53.M59-332T2W	157	H1200NC25Y	133	M0130SL200	113
		E53.M59-602T2W	157	K		M0130SL250	113
		E53.M59-802T2W	157	➤ K0445LG600	123	M0130SM200	113
		E53.N51-303H1W	157	➤ K0445LG650	123	M0130SM250	113
		E53.N51-383H1W	157	➤ K0500LC600	123	M0139RL120	113
		E53.N51-503H1W	157	➤ K0500LC650	123	M0139RL180	113
		E53.N68-403H1W	157	➤ K0560QE600	123	M0139RM120	113
		E53.N68-503H1W	157	➤ K0560QE650	123	M0139RM180	113
		E53.P59-103T2W	157	➤ K0625QA600	123	M0139RL200	113
		E53.P59-143T2W	157	➤ K0625QA650	123	M0139SL180	113
		E53.P59-163T2W	157	K0890NC360	123	M0139SM120	113
		E53.P59-303T2W	157	K0890NC420	123	M0139SM180	113
		E53.P59-402T2W	157	➤ K0900ME600	123	M0225YH360	114
		E53.P59-503T2W	157	➤ K0900ME650	123	M0225YH450	114
		E53.P59-682T2W	157	○ K1000MA600	123	M0268RC200	113
		E53.P59-752T2W	157	○ K1000MA650	123	M0268RC250	113
		E53.Q59-103T2W	157	○ K1000ME600	123	M0268RJ200	113
		E53.Q59-143T2W	157	○ K1000ME650	123	M0268RJ250	113
		E53.Q59-153T2W	157	➤ K1010MA600	123	M0268SC200	113
		E53.Q59-183T2W	157	➤ K1010MA650	123	M0268SC250	113
		E53.Q59-223T2W	157	K1120NC360	123	M0268SJ200	113
		E53.Q59-403T2W	157	K1120NC420	123	M0268SJ250	113
		E53.Q59-502T2W	157	K1120NG360	123	M0280RC200	113
		E53.Q59-602T2W	157	K1120NG420	123	M0280RC250	113
		E53.Q59-802T2W	157	K1121NC320	123	M0280RJ200	113
		E53.R11-302T2W	157	K1121NC360	123	M0280RJ250	113
		E53.R11-402T2W	157	K1197NC300	123	M0280SC200	113
		E53.R60-123T2W	157	K1197NC320	123	M0280SC250	113
		E53.R60-183T2W	157	➤ K1495HE600	123	M0280SJ200	113
		E53.R60-243T2W	157	➤ K1495HE650	123	M0280SJ250	113
		E53.R60-333T2W	157	➤ K1670HA600	123	M0310YH300	114
		E53.R60-503T2W	157	➤ K1670HA650	123	M0310YH350	114
		E53.R60-702T2W	157	K1947ZC400	124	M0334RC120	113
		F		K1947ZC450	124	M0334RC200	113
		F0240YC250	116	K1947ZD400	124	M0334RJ120	113
		F0240YC300	116	K1947ZD450	124	M0334RJ200	113

Alphanumeric Index

> New
 ○ Not for new design
 ◇ Under development

M0334SC120	113	M1565VC450	115	MCC720-14io7	136	MDC431-24io2	137
M0334SC200	113	M1565VF360	115	MCC720-18io7	136	○ MDC500-14io1	137
M0334SJ120	113	M1565VF400	115	> MCD160-14io3	137	○ MDC500-18io1	137
M0334SJ200	113	M1565VF450	115	> MCD160-18io3	137	○ MDC500-22io1	137
M0336RA120	113	M1583VC400	112	> MCD220-28io3	137	MDC500-30io7	137
M0336RA140	113	M1583VC450	112	> MCD265-24io3	137	MDC500-36io7	137
M0336SA120	113	M1583VF400	112	MCD320-30io2	137	MDC501-12io2	137
M0336SA140	113	M1583VF450	112	MCD320-36io2	137	MDC501-14io2	137
M0347WC200	114	M1609NC200	112	> MCD325-14io3	137	MDC501-16io2	137
M0347WC250	114	M1609NC260	112	> MCD325-18io3	137	MDC501-18io2	137
M0358WC120	114	M1609ND200	112	> MCD380-28io2	137	MDC552-12io2	137
M0358WC180	114	M1609ND260	112	MCD431-20io2	137	MDC552-14io2	137
M0367WC220	114	M1858NC120	115	MCD431-22io2	137	MDC552-16io2	137
M0367WC280	114	M1858NC160	115	MCD431-24io2	137	MDC580-28io7	137
M0371YH350	114	M1858ND120	115	○ MCD500-14io1	137	MDC600-22io1W	140
M0371YH450	114	M1858ND160	115	○ MCD500-18io1	137	MDC650-24io7	137
M0433WC120	114	M2273VC300	112	○ MCD500-22io1	137	MDC700-14io1W	140
M0433WC160	114	M2273VC360	112	MCD500-30io7	137	MDC700-18io1W	140
M0433WC200	114	M2273VF300	112	MCD500-36io7	137	MDC720-14io7	137
M0437WC080	114	M2273VF360	112	MCD501-12io2	137	MDC720-18io7	137
M0437WC140	114	M2322ZC300	115	MCD501-14io2	137	MDD 710-22N2	138
M0588LC400	112	M2322ZC400	115	MCD501-16io2	137	MDD 710-26N2	138
M0588LC450	112	M2322ZD300	115	MCD501-18io2	137	MDD 810-12N2	138
M0659LC400	114	M2322ZD400	115	MCD552-12io2	137	MDD 810-16N2	138
M0659LC450	114	M2408NC020	112	MCD552-14io2	137	MDD 810-18N2	138
M0710LC560	114	M2408NC060	112	MCD552-16io2	137	MDD1080-18N7	139
M0710LC600	114	M2408ND020	112	MCD580-28io7	137	MDD1080-24N7	139
M0736LC400	114	M2408ND060	112	MCD600-22io1W	140	MDD1080-28N7	139
M0736LC450	114	M2413VC200	115	MCD650-24io7	137	> MDD275-30N3	138
M0759YC120	114	M2413VC250	115	MCD700-14io1W	140	> MDD275-36N3	138
M0759YC160	114	M2413VF200	115	MCD700-18io1W	140	> MDD410-24N3	138
M0759YH120	114	M2413VF250	115	MCD720-14io7	137	> MDD410-28N3	138
M0759YH160	114	M2639ZC420	112	MCD720-18io7	137	> MDD510-14N3	138
M0790YC200	112	M2639ZC450	112	○ MCK500-14io1	136	> MDD510-18N3	138
M0790YC250	112	M2639ZD420	112	○ MCK500-18io1	136	○ MDD600-14N1	138
M0790YH200	112	M2639ZD450	112	○ MCK500-22io1	136	○ MDD600-18N1	138
M0790YH250	112	M2698ZC250	112	MCK600-22io1W	140	○ MDD600-22N1	138
M0859LC140	114	M2698ZC280	112	MCK700-14io1W	140	MDD630-30N2	138
M0859LC160	114	M2698ZC350	112	MCK700-18io1W	140	MDD630-36N2	138
M0863LC260	114	M2698ZD250	112	> MCO560-30io1	136	MDD950-14N1W	140
M0863LC300	114	M2698ZD280	112	> MCO560-36io1	136	MDD950-18N1W	140
M0863LC360	114	M2698ZD350	112	> MCO635-28io1	136	MDD950-22N1W	140
M0872LC140	114	M2837VC180	112	MCO741-22io1	136	MDK 710-22N2	138
M0872LC180	114	M2837VC250	112	MCO801-14io1	136	MDK 710-26N2	138
M0872LC210	114	M2837VF180	112	MCO801-18io1	136	MDK 810-12N2	139
M0914LC200	112	M2837VF250	112	MCR500-30io7	136	MDK 810-16N2	139
M0914LC250	112	M3770ZC200	112	MCR500-36io7	136	MDK 810-18N2	139
M0955LC200	114	M3770ZC240	112	MCR580-28io7	136	MDK1080-18N7	139
M0955LC250	114	M3770ZC300	112	MCR650-24io7	136	MDK1080-24N7	139
M1010NC400	112	M3770ZD200	112	MCR720-14io7	136	MDK1080-28N7	139
M1010NC450	112	M3770ZD240	112	MCR720-18io7	136	> MDK275-30N3	138
M1010ND400	112	M3770ZD300	112	MDA 710-22N2	138	> MDK275-36N3	138
M1010ND450	112	MCA600-22io1W	140	MDA 710-26N2	138	> MDK410-24N3	138
M1022LC120	114	MCA700-14io1W	140	MDA 810-12N2	139	> MDK410-28N3	138
M1022LC160	114	MCA700-18io1W	140	MDA 810-16N2	139	> MDK510-14N3	138
M1022LC200	114	> MCC160-30io3	136	MDA 810-18N2	139	> MDK510-18N3	138
M1080LC100	114	> MCC160-36io3	136	MDA1080-18N7	139	○ MDK600-14N1	138
M1080LC120	114	> MCC220-28io3	136	MDA1080-24N7	139	○ MDK600-18N1	138
M1102NC500	115	> MCC265-24io3	136	MDA1080-28N7	139	○ MDK600-22N1	138
M1102NC600	115	MCC320-30io2	136	> MDA275-30N3	138	MDK630-30N2	138
M1102ND500	115	MCC320-36io2	136	> MDA275-36N3	138	MDK630-36N2	138
M1102ND600	115	> MCC325-14io3	136	> MDA410-24N3	138	MDK950-14N1W	140
M1104NC400	115	> MCC325-18io3	136	> MDA410-28N3	138	MDK950-18N1W	140
M1104NC450	115	> MCC380-28io2	136	> MDA510-14N3	138	MDK950-22N1W	140
M1104ND400	115	MCC431-20io2	136	> MDA510-18N3	138	> MDO1120-24N1	139
M1104ND450	115	MCC431-22io2	136	○ MDA600-14N1	138	> MDO1120-28N1	139
M1163NC400	112	MCC431-24io2	136	○ MDA600-18N1	138	MDO1201-14N1	139
M1163NC450	112	○ MCC500-14io1	136	○ MDA600-22N1	138	MDO1201-18N1	139
M1163ND400	112	○ MCC500-18io1	136	MDA630-30N2	138	MDO1201-22N1	139
M1163ND450	112	○ MCC500-22io1	136	MDA630-36N2	138	N	
M1242NC260	115	MCC500-30io7	136	MDA950-14N1W	140	N0180SH120	118
M1242NC360	115	MCC500-36io7	136	MDA950-18N1W	140	N0180SH160	118
M1242ND260	115	MCC501-12io2	136	MDA950-22N1W	140	N0335SC120	118
M1242ND360	115	MCC501-14io2	136	> MDC160-14io3	137	N0335SC160	118
M1494NC160	115	MCC501-16io2	136	> MDC160-18io3	137	N0416SC040	118
M1494NC250	115	MCC501-18io2	136	> MDC220-28io3	137	N0416SC080	118
M1494ND160	115	MCC552-12io2	136	> MDC265-24io3	137	N0465WN140	119
M1494ND250	115	MCC552-14io2	136	MDC320-30io2	137	N0465WN160	119
M1502NC200	112	MCC552-16io2	136	MDC320-36io2	137	N0530YN220	119
M1502NC250	112	MCC580-28io7	136	> MDC325-14io3	137	N0530YN250	119
M1502ND200	112	MCC600-22io1W	140	> MDC325-18io3	137	N0616LC400	119
M1502ND250	112	MCC650-24io7	136	> MDC380-28io2	137	N0616LC450	119
M1565VC360	115	MCC700-14io1W	140	MDC431-20io2	137	N0634LC380	119
M1565VC400	115	MCC700-18io1W	140	MDC431-22io2	137	N0634LC420	119

Alphanumeric Index

- New
- Not for new design
- ◇ Under development

N0646LC300	119	○ N2500VF160	120	N4803FD350	122	P0848YC06C	126
N0646LC360	119	N2520ML080	120	N5177FC200	122	P1007LC08D	126
N0795YN140	119	N2520ML120	120	N5177FC280	122	P1007LC08E	126
N0795YN180	119	N2520ML140	120	N5177FD200	122	P1007LC08F	126
N0882NC400	119	N2543ZC240	121	N5177FD280	122	P1007LC12D	126
N0882NC450	119	N2543ZC300	121	N5946FC180	122	P1007LC12E	126
N0910LC200	119	N2543ZD240	121	N5946FC220	122	P1007LC12F	126
N0910LC260	119	N2543ZD300	121	N5946FD180	122	R	
N1010NC300	119	N2593MK160	121	N5946FD220	122	R0472YC12E	127
N1010NC380	119	N2593MK180	121	N6012ZD020	122	R0472YC12F	127
N1075LN180	119	N2600MC160	121	N6012ZD040	122	R0472YC16E	127
N1132NC300	119	N2600MC180	121	N6012ZD060	122	R0472YC16F	127
N1132NC320	119	N2825TE400	121	N6974HK020	122	R0487YC12D	127
N1140LN140	119	N2825TE450	121	N6974HK040	122	R0487YC12E	127
N1159NC380	119	N2825TJ400	121	N6974HK060	122	R0487YC14D	127
N1159NC420	119	N2825TJ450	121	P		R0487YC14E	127
N1174JK200	119	➤ N2830HE260	121	P0128SH10C	125	R0577YC12C	127
N1174JK220	119	➤ N2830HE280	121	P0128SH10D	125	R0577YC12D	127
N1263JK160	119	N2900QL020	121	P0128SH10E	125	R0577YC12E	127
N1263JK180	119	N2900QL040	121	P0128SH12C	125	R0633YC12D	127
N1351VC400	119	N2900QL060	121	P0128SH12D	125	R0633YC12E	127
N1351VC450	119	N3012ZC200	121	P0128SH12E	125	R0633YC12F	127
N1351VF400	119	N3012ZC260	121	P0128SJ10C	125	R0717LC14G	127
N1351VF450	119	N3012ZD200	121	P0128SJ10D	125	➤ R0717LC18G	127
N1366JK080	119	N3012ZD260	121	P0128SJ10E	125	R0736LC20J	127
N1366JK120	119	N3022MK080	121	P0128SJ12C	125	R0736LC20K	127
N1366JK140	119	N3022MK120	121	P0128SJ12D	125	R0736LC22J	127
N1449QL200	119	N3022MK140	121	P0128SJ12E	125	R0736LC22K	127
N1449QL220	119	N3029ZC240	121	P0248SC12D	125	R0736LC25J	127
N1467NC200	119	N3029ZC280	121	P0248SC12E	125	R0736LC25K	127
N1467NC260	119	N3029ZD240	121	P0273SC12D	125	R0736LC25L	127
N1547NC160	119	N3029ZD280	121	P0273SC12E	125	R0736LC25M	127
N1547NC200	119	➤ N3165HA260	121	P0273SC12F	125	R0809LC10A	127
N1581QL160	119	➤ N3165HA280	121	P0295WC12D	126	R0809LC10B	127
N1581QL180	119	➤ N3175HE160	121	P0295WC12E	126	R0830LC12C	127
N1651QK200	119	➤ N3175HE180	121	P0306SC08A	125	R0830LC12D	127
N1651QK220	119	N3229QK020	121	P0306SC08B	125	R0830LC12E	127
N1661VC300	119	N3229QK040	121	P0306SC08C	125	R0830LC12F	127
N1661VC360	119	N3229QK060	121	P0311SC12E	125	R0830LC14C	127
N1661VF300	119	N3533ZC180	121	P0311SC12F	125	R0830LC14D	127
N1661VF360	119	N3533ZC220	121	P0327WC08C	126	R0830LC14E	127
N1718NC120	120	N3533ZD180	121	P0327WC08D	126	R0830LC14F	127
N1718NC180	120	N3533ZD220	121	P0327WC08E	126	R0878LC18K	127
N1718NC200	120	➤ N3565HA160	121	P0327WC08F	126	R0878LC18L	127
➤ N1725MC320	120	➤ N3565HA180	121	P0327WC12C	126	R0878LC18M	127
➤ N1725MC360	120	N3597ML020	121	P0327WC12D	126	R0878LC20K	127
N1802NC120	120	N3597ML040	121	P0327WC12E	126	R0878LC20L	127
N1802NC160	120	N3597ML060	121	P0327WC12F	126	R0878LC20M	127
N1806QK160	120	N3790TE240	121	P0330SC04A	125	R0878LC21K	127
N1806QK180	120	N3790TE280	121	P0330SC04C	125	R0878LC21L	127
N1817QL080	120	N3790TJ240	121	P0330SC06A	125	R0878LC21M	127
N1817QL120	120	N3790TJ280	121	P0330SC06C	125	R0929LC10A	127
N1817QL140	120	N3839TC300	122	P0330SC08A	125	R0929LC10B	127
N2015ML200	120	N3839TC350	122	P0330SC08C	125	R0929LC10C	127
N2015ML220	120	N3839TD300	122	P0366WC04A	126	R0929LC12A	127
➤ N2055MC260	120	N3839TD350	122	P0366WC04B	126	R0929LC12B	127
➤ N2055MC280	120	N3880ZD160	122	P0366WC04C	126	R0929LC12C	127
N2083QK080	120	N3880ZD180	122	P0366WC06A	126	R0929LC12D	127
N2083QK120	120	N3904HK200	122	P0366WC06B	126	R0929LC12E	127
N2083QK140	120	N3904HK220	122	P0366WC06C	126	R0964LC10C	127
N2086NC060	120	N3930ZC120	122	P0366WC08A	126	R0964LC10D	127
N2086NC100	120	N3930ZC160	122	P0366WC08B	126	R0964LC10E	127
N2154JK020	120	N3930ZD120	122	P0366WC08C	126	R0964LC12C	128
N2154JK040	120	N3930ZD160	122	P0367WC12E	126	R0964LC12D	128
N2154JK060	120	N4085ZC080	122	P0367WC12F	126	R0964LC12E	128
N2172ZC400	120	N4085ZC120	122	P0389WC04B	126	R0990LC08A	128
N2172ZC450	120	N4085ZD080	122	P0389WC04C	126	R0990LC08B	128
N2172ZD400	120	N4085ZD120	122	P0389WC08B	126	R0990LC08C	128
N2172ZD450	120	N4151FC360	122	P0389WC08C	126	R1124NC18J	128
N2191ML160	120	N4151FC420	122	P0431SC04B	125	R1124NC18K	128
N2191ML180	120	N4151FD360	122	P0431SC04C	125	R1124NC18L	128
○ N2293VC180	120	N4151FD420	122	P0431SC06B	125	R1124NC18M	128
○ N2293VC220	120	N4316MK020	122	P0431SC06C	125	R1124NC20J	128
○ N2293VF180	120	N4316MK040	122	P0515WC04B	126	R1124NC20K	128
○ N2293VF220	120	N4316MK060	122	P0515WC04C	126	R1124NC20L	128
N2367MK200	120	➤ N4340TE180	122	P0515WC04D	126	R1124NC20M	128
N2367MK220	120	➤ N4340TE220	122	P0515WC06B	126	R1124NC21J	128
N2418ZC300	120	➤ N4340TJ180	122	P0515WC06C	126	R1124NC21K	128
N2418ZC360	120	➤ N4340TJ220	122	P0515WC06D	126	R1124NC21L	128
N2418ZD300	120	N4472HK160	122	P0838LC06B	126	R1124NC21M	128
N2418ZD360	120	N4472HK180	122	P0838LC06C	126	R1127NC32P	128
○ N2500VC120	120	N4803FC300	122	P0848YC04B	126	R1127NC32R	128
○ N2500VC160	120	N4803FC350	122	P0848YC04C	126	R1127NC32S	128
○ N2500VF120	120	N4803FD300	122	P0848YC06B	126	R1127NC32T	128

Alphanumeric Index

- > New
- Not for new design
- ◇ Under development

R1127NC34R	128	R1955MC16E	129	R3559TC20N	131	T	
R1127NC34S	128	R1955MC16F	129	R3559TD16K	131	T0160NB45A	134
R1127NC34T	128	> R2075MC12A	129	R3559TD16M	131	T0240NB45E	134
R1127NC36R	128	> R2075MC12B	129	R3559TD16N	131	T0258HF65G	134
R1127NC36S	128	> R2075MC12C	129	R3559TD20K	131	T0340VB45G	134
R1127NC36T	128	R2475ZC28M	129	R3559TD20M	131	T0360ND25A	134
R1158NC26N	128	R2475ZC28N	129	R3559TD20N	131	T0385HF65E	134
R1158NC26P	128	R2475ZC28R	129	R3636EC16K	131	T0500ND25E	134
R1158NC26T	128	R2475ZD28M	130	R3636EC16M	131	T0510VB45E	134
R1178NC14E	128	R2475ZD28N	130	R3636EC16N	131	T0570VD25G	134
R1178NC14F	128	R2475ZD28R	130	R3636EC20K	131	T0600AF65G	134
R1178NC14G	128	R2619ZC18J	130	R3636EC20M	131	T0600TB45A	134
R1211NC12C	128	R2619ZC18K	130	R3636EC20N	131	T0800EB45G	134
R1211NC12D	128	R2619ZC18L	130	R3708FC45V	131	T0800TB45E	134
R1211NC12E	128	R2619ZC20J	130	R3708FC45W	131	T0850VD25E	134
R1271NC12B	128	R2619ZC20K	130	R3708FD45V	131	T0900AF65E	134
R1271NC12C	128	R2619ZC20L	130	R3708FD45W	131	T0900DF65A	134
R1271NC12D	128	R2619ZC21J	130	R3968FC24K	131	T0900EB45A	134
R1271NC12E	128	R2619ZC21K	130	R3968FC24M	131	T1200EB45E	134
R1275NC18J	128	R2619ZC21L	130	R3968FC24N	131	T1200TD25A	134
R1275NC18K	128	R2619ZC25J	130	R3968FC28K	131	T1290BF65A	134
R1275NC18L	128	R2619ZC25K	130	R3968FC28M	131	T1375DF65E	134
R1275NC18M	128	R2619ZC25L	130	R3968FC28N	131	T1500TD25E	134
R1275NC20J	128	R2619ZD18J	130	R3968FD24K	131	T1600GB45G	134
R1275NC20K	128	R2619ZD18K	130	R3968FD24M	131	T1800GB45A	134
R1275NC20L	128	R2619ZD18L	130	R3968FD24N	131	T1890BF65E	134
R1275NC20M	128	R2619ZD20J	130	R3968FD28K	131	T2250AD25E	134
R1275NC21J	128	R2619ZD20K	130	R3968FD28M	131	T2400GB45E	134
R1275NC21K	128	R2619ZD20L	130	R3968FD28N	131		
R1275NC21L	128	R2619ZD21J	130	S		W	
R1275NC21M	128	R2619ZD21K	130	S0300SR12Y	133	W0428RE250	108
R1279NC22J	128	R2619ZD21L	130	S0500KC200	133	W0428RE280	108
R1279NC22K	128	R2619ZD25J	130	S0500KC20Y	133	W0428RE320	108
R1279NC22L	128	R2619ZD25K	130	S0500KC25D	133	W0428RF250	108
R1279NC22M	128	R2619ZD25L	130	S0500KC25Y	133	W0428RF280	108
R1279NC25J	128	R2620ZC22J	130	S0500YC20Y	133	W0428RF320	108
R1279NC25K	128	R2620ZC22K	130	S0500YC25Y	133	W0428SE250	108
R1279NC25L	128	R2620ZC22L	130	S0700KC140	133	W0428SE280	108
R1279NC25M	128	R2620ZC25J	130	S0700KC14Y	133	W0428SE320	108
R1280NC21J	129	R2620ZC25K	130	S0700KC17D	133	W0428SF250	108
R1280NC21K	129	R2620ZC25L	130	S0700KC17Y	133	W0428SF280	108
R1280NC21L	129	R2620ZD22J	130	S1000NC300	133	W0428SF320	108
R1280NC21M	129	R2620ZD22K	130	S1000NC30Y	133	W0503RC160	108
R1280NC22J	129	R2620ZD22L	130	S1000NC36D	133	W0503RC200	108
R1280NC22K	129	R2620ZD25J	130	S1000NC36M	133	W0503RC240	108
R1280NC22L	129	R2620ZD25K	130	S1200NC200	133	W0503SC160	108
R1280NC22M	129	R2620ZD25L	130	S1200NC20Y	133	W0503SC200	108
R1280NC25J	129	R2714ZC14H	130	S1200NC25D	133	W0503SC240	108
R1280NC25K	129	R2714ZC14J	130	S1200NC25Y	133	W0507YH360	109
R1280NC25L	129	R2714ZC14K	130	SXB11987HEX	144	W0507YH450	109
R1280NC25M	129	R2714ZC18H	130	SXB1265FB	144	W0642WC160	109
R1331NC10B	129	R2714ZC18J	130	SXB1375B	144	W0642WC200	109
R1331NC10C	129	R2714ZC18K	130	SXB1645FB	144	W0642WC240	109
R1331NC10D	129	R2714ZD14H	130	SXB1764FG	144	W0735RA120	108
R1331NC12B	129	R2714ZD14J	130	SXB1920G	144	W0735RA150	108
R1331NC12C	129	R2714ZD14K	130	SXB2096B	144	W0735SA120	108
R1331NC12D	129	R2714ZD18H	130	SXB2167FB	144	W0735SA150	108
R1446NC12C	129	R2714ZD18J	130	SXB2324FG	144	W0944WC120	109
R1446NC12D	129	R2714ZD18K	130	SXB2939G	144	W0944WC150	109
R1446NC12E	129	R3047TC24K	130	SXB3120FG	144	W1032LC500	109
R1446NC12F	129	R3047TC24L	130	SXB3442B	144	W1032LC600	109
R1448NC14H	129	R3047TC24M	130	SXB3529HEXT	144	W1074YC200	109
R1448NC14J	129	R3047TC24N	130	SXB3840HEX	144	W1074YC260	109
R1448NC18H	129	R3047TC28K	131	SXB4264B	144	W1074YC320	109
R1448NC18J	129	R3047TC28L	131	SXB4649HEXT	144	W1074YH200	109
R1448NC20H	129	R3047TC28M	131	SXB4869G	144	W1074YH260	109
R1448NC20J	129	R3047TC28N	131	SXB5877HEX	144	W1074YH320	109
R1448NC20K	129	R3047TD24K	131	SXB5993G	144	W1185LC300	109
R1448NC20L	129	R3047TD24L	131	SXB6240HEXT	144	W1185LC380	109
R1448NC20M	129	R3047TD24M	131	SXB9737HEX	144	W1185LC450	109
R1700MC18E	129	R3047TD24N	131	SXC1076FB	147	W1185LC450KBN	149
R1700MC18F	129	R3047TD28K	131	SXC1195FR	147	W1185LC450KBR	149
R1700MC18G	129	R3047TD28L	131	SXC1318FB	147	W1185LC450KCN	149
R1700MC18H	129	R3047TD28M	131	SXC1464FR	147	W1185LC450KCR	149
R1700MC18J	129	R3047TD28N	131	SXC1517FG	147	W1263YC160	109
R1700MC21E	129	R3370ZC12C	131	SXC1609FB	147	W1263YC200	109
R1700MC21F	129	R3370ZC12D	131	SXC1788FR	147	W1263YC250	109
R1700MC21G	129	R3370ZC12E	131	SXC1871FG	147	W1263YH160	109
R1700MC21H	129	R3559TC16K	131	SXC2319FG	147	W1263YH200	109
R1700MC21J	129	R3559TC16M	131	SXF30xxxxAN	155	W1263YH250	109
R1955MC14D	129	R3559TC16N	131	SXF46xxxxAN	155	W1411LC300	109
R1955MC14E	129	R3559TC20K	131	SXFLPxxxxAN	155	W1411LC360	109
R1955MC14F	129	R3559TC20M	131			W1411LC360KBN	149
R1955MC16D	129						

Alphanumeric Index

- New
- Not for new design
- ✦ Under development

W1411LC360KBR	149	W3864QK180	110	XK0450BB025M	155	XSK065	152
W1411LC360KCN	149	W4096ZC340	110	XK0450DA056M	150	XSK065	152
W1411LC360KCR	149	W4096ZC450	110	XK0450DT056M	150	XSK075	152
W1520NC500	109	W4096ZD340	110	XK0450SA056M	150	XSK075	152
W1520NC600	109	W4096ZD450	110	XK0550DA056M	150	XSK087	152
W1524LC240	109	➤ W4205TE520	110	XK0550SA056M	150	XSK087	152
W1524LC300	109	➤ W4205TE560	110	XK0600DA074M	150	XSK103	152
W1524LC300KBN	149	➤ W4205TE600	110	XK0600SA074M	150	XSK103	152
W1524LC300KBR	149	➤ W4205TJ520	110	○ XK0900DA056M	150	XSK112	152
W1524LC300KCN	149	➤ W4205TJ560	110	○ XK0900DT056M	150	XSK112	152
W1524LC300KCR	149	➤ W4205TJ600	110	XK0900SA056M	150	XSK120	152
W1748LC180	109	W4534NC020	110	➤ XK1000BA025M	155	XSK120	152
W1748LC220	109	W4534NC060	110	XK1000DA074M	150	XSK126	152
W1748LC220KBN	149	W4693QK050	110	XK1000SA074M	150	XSK126	152
W1748LC220KBR	149	W4693QK080	110	XK1100DA076M	150	XSK1500DA076038	154
W1748LC220KCN	149	W4693QR050	110	XK1130DA076M	150	XSK1500DA076076	154
W1748LC220KCR	149	W4693QR080	110	XK1130DT076M	150	XSK1500DA076101	154
W1748LC250	109	W4713HL300	110	XK1130SA076M	150	XSK2000DA076038	154
W2054NC360	109	W4713HL350	110	XK1130SB076M	149	XSK2000DA076076	154
W2054NC450	109	W4713HM300	110	XK1500BA025M	155	XSK2000DA076101	154
W2058LC100	109	W4713HM350	110	XK1500BA034M	155	XSK3000DA076038	154
W2058LC120	109	W4767MC180	110	XK1500CB034M	149	XSK3000DA076076	154
W2058LC120KBN	149	W4767MC220	110	XK1800DA076M	150	XSK3000DA076101	154
W2058LC120KBR	149	W5092ZC320	110	XK1800DT076M	150	XSK3400DA076038	154
W2058LC120KCN	149	W5092ZC350	110	XK1800SA076M	150	XSK3400DA076076	154
W2058LC120KCR	149	W5092ZD320	110	XK2000DA114M	150	XSK3400DA076101	154
W2058LC140	109	W5092ZD350	110	XK2000SA114M	150	XSK3800DA116M076	154
W2115MC520	109	W5130MK240	111	XK2100DA076M	150	XSK3800DA116M101	154
W2115MC560	109	W5130MK280	111	XK2100DA076ML	150	XSK4400DA116M076	154
W2115MC600	109	W5139TE400	111	XK2100SA076M	150	XSK4400DA116M101	154
W2134NC300	109	W5139TE480	111	XK2100SA076ML	150	XSK6000DA116M076	154
W2134NC400	109	W5139TJ400	111	○ XK2140DA076M	150	XSK6000DA116M101	154
W2820VC360	109	W5139TJ480	111	○ XK2140DA076ML	150	XSL1000C2WRP	148
W2820VC450	109	W5282ZC240	111	○ XK2140DT076M	150	XSL1000C2WRT	148
W2820VF360	109	W5282ZC300	111	○ XK2140DT076ML	150	XSL1100C2WRT	148
W2820VF450	109	W5282ZD240	111	XK2140SA076M	150	XSL200D8WRC	148
W2899MC420	109	W5282ZD300	111	XK2140SA076ML	150	XSL200D8WRCP	148
W2899MC460	109	W5334MK200	111	XK2140SB076M	149	XSL220C2WRT	148
W2899MC480	109	W5334MK220	111	XK2500DA114M	150	XSL300C2WRP	148
W3082MC420	109	W5636MC120	111	XK2500DA116M	150	XSL300C2WS	148
W3082MC440	109	W5636MC140	111	XK2500DA116ML	150	XSL350C2WRP	148
W3082MC450	109	W5636MC150	111	XK2500SA114M	150	XSL400C2WRP	148
W3082MC450KDN	149	W5636MC150KDN	149	XK2500SA116M	150	XSL500C2WRP	148
W3082MC450KDR	149	W5636MC150KDR	149	XK2500SA116ML	150	XSL600C2WRP	148
W3128VC300	109	W5696VC100	111	XK2700DA076M	150	XSNM10H15P	156
W3128VC400	109	W5696VC140	111	XK2700DT076M	150	XSNM12H10S	156
W3128VF300	109	W5696VF100	111	XK2700SA076M	150	XSNM12H12S	156
W3128VF400	109	W5696VF140	111	○ XK3000DA116M	150	XST1000M08P	148
W3270NC200	110	W5838ZC180	111	○ XK3000DA116ML	150	XST1000M10P	148
W3270NC20A	110	W5838ZC220	111	XK3000SA116M	150	XST1000M12P	148
W3270NC220	110	W5838ZD180	111	XK3000SA116ML	150	XST1000M16P	148
W3270NC22A	110	W5838ZD220	111	XK3060DA140ML	151	XW076NC16A	156
➤ W3305QK240	110	W5984TE360	111	XK3060SA140ML	151	XW076NC16B	156
➤ W3305QK280	110	W5984TE400	111	XK3500DA116M	150	XW076NC16BS	156
W3455QK200	110	W5984TJ360	111	XK3500DA116ML	150	XW076NC16BT	156
W3455QK220	110	W5984TJ400	111	XK3500SA116M	150	XW076NC16C	156
W3477MC360	110	W6262ZC200	111	XK3500SA116ML	150	XW076NC16CT	156
W3477MC380	110	W6262ZC240	111	○ XK4000DA116M	150	XW076NC16R	156
W3477MC400	110	W6262ZD200	111	○ XK4000DA116ML	150	XW076NC16W	156
W3697VC220	110	W6262ZD240	111	XK4000SA116M	150	XW116ZC20A	156
W3697VC280	110	W6908FC450	111	XK4000SA116ML	150	XW116ZC20B	156
W3697VF220	110	W6908FC500	111	XK5000DA128M	151	XW116ZC20C	156
W3697VF280	110	W6908FD450	111	XK5000DA128ML	151	XW116ZC20R	156
W3708MC300	110	W6908FD500	111	XK6120DA180ML	151	XW116ZC20W	156
W3708MC320	110	➤ W7032DB020	111	XK6120SA180ML	151	XW127EA25A	156
W3708MC350	110	➤ W7032DB040	111	XK7000DA128M	151	XW127EA25B	156
W3708MC350KDN	149	W7045MC030	111	XK7000DA128ML	151	XW127EC25A	156
W3708MC350KDR	149	W7045MC060	111	XK9000DA160M	151	XW127EC25B	156
W3743ZC400	110	W8405ZC100	111	XK9000DA160ML	151	XW127EN15A	156
W3743ZC450	110	W8405ZC140	111	XK9000SA160M	151	XW127EN15B	156
W3743ZC500	110	W8405ZD100	111	XK9000SA160ML	151	XW160FC25A	156
W3743ZD400	110	W8405ZD140	111	XSFGAxxxxAN	155	XW160FC25B	156
W3743ZD450	110	W8570TE180	111	XSFGxxxxAN	155	XW180GA34A	156
W3743ZD500	110	W8570TE220	111	XSFHxxxxAN	155	XW180GA34B	156
W3841VC300	110	W8570TJ180	111	XSFTBxxxxAN	155	XW180GC34A	156
W3841VC340	110	W8570TJ220	111	XSFTCxxxxAN	155	XW180GC34B	156
W3841VF300	110	W9830TE120	111	XSFTxxxxAN	155	XW180GN25A	156
W3841VF340	110	W9830TE150	111	XSGSCX13	148	XW270QA25A	156
W3842MC240	110	W9830TJ120	111	XSK042	152	Y	
W3842MC280	110	W9830TJ150	111	XSK042	152	Y200CKC250	132
W3842MC280KDN	149	X		XSK054	152	Y500CNC250	132
W3842MC280KDR	149	XK0450BA019M	155	XSK054	152		
W3864QK120	110	XK0450BA025M	155	XSK056	152		
W3864QK150	110	XK0450BB019M	155	XSK056	152		

Symbols and Terms

a	Acceleration	I_{FM}	Maximum forward current
BV_{CES}	Collector emitter breakdown voltage	I_{FAV}	Average forward current
BV_{DSS}	Drain source breakdown voltage	$I_{F(AV)M}, I_{T(AV)M}$	Maximum average forward current
C_{ies}, C_{iss}	Input capacitance	I_{FLT}	Sink current of fault terminal
C_{oes}, C_{oss}	Output capacitance	I_{FRM}	Maximum repetitive forward current
C_{res}, C_{rss}	Reverse transfer (Miller) capacitance	$I_{F(RMS)}, I_{T(RMS)}$	RMS forward current
d	Duty cycle	I_{FSM}, I_{TSM}	Maximum surge forward current
d_A	Strike distance through air	I_G, I_{GT}	Trigger gate current
$di/dt, -di/dt$	Rate of change of current	I_{GD}	Non-trigger gate current
$(di/dt)_{cr}$	Critical rate of rise of current	I_{GES}	Gate emitter leakage current
$di_F/dt, -di_F/dt$	Rate of change of forward current	I_H	Holding current
d_s	Creep distance on surface	$I_{IN(H)}$	Signal input current (high level)
dv/dt	Rate of rise of voltage	$I_{IN(L)}$	Signal input current (low level)
$(dv/dt)_{cr}$	Critical rate of rise of voltage	I_{ISOL}	RMS current for isolation test
E_{AR}	Repetitive avalanche energy	I_L	Latching current
E_{AS}	Non-repetitive avalanche energy	I_R	Reverse current
E_{off}	Turn-off energy per pulse	I_{RM}	Maximum reverse recovery current
E_{on}	Turn-on energy per pulse	I_{RMS}	RMS current
$E_{rec(off)}$	Reverse recovery losses at turn-off	I_{RRM}	Maximum repetitive reverse current
$F_{(mounting)}$	Required force to mount hole-less discretes on heat sink	I_S	Continuous source current
g_{fs}	Forward transconductance	I_{SM}	Maximum pulsed source current
I_{AR}	Repetitive avalanche current	I^2t	I^2t value for fusing
I_{AVM}	Maximum average forward current	I_{TSM}	Maximum surge on-state current
I_{BO}	Breakover current	K_f	Characteristic factor
$I_{C(on)}$	Short circuit current	K_p	Coeff. for energy per pulse E_p (material constant)
I_C	Collector current	K_T	Temperature coefficient of VBO
I_{C25}	Continuous DC collector current at $T_C = 25^\circ C$	L	Series stray inductance
I_{C90}	Continuous DC collector current at $T_C = 90^\circ C$	M_d	Mounting torque
I_{CES}	Collector emitter leakage current	P_C	Collector power dissipation
I_{CM}	Maximum pulsed collector current	P_D	Power dissipation
I_D	Drain current	P_{GAV}	Average gate power dissipation
I_{DD}	Module supply current, operating mode	$P_{G(AV)M}$	Maximum average gate power dissipation
I_{DD0}	Module supply current, standby mode	P_{GM}	Maximum gate power dissipation
$I_{D(cont)}$	Continuous drain current	P_{RSM}	Maximum surge reverse power dissipation
I_{D25}	Continuous drain current at $T_C = 25^\circ C$	P_{T}, P_{tot}	Total power dissipation
I_{DAV}	Average DC output current	Q_g	Total gate charge
$I_{D(AV)M}$	Maximum average DC output current	Q_{gc}	Gate collector (Miller) charge
I_{DM}	Maximum pulsed drain current	Q_{gd}	Gate drain (Miller) charge
I_{DRM}	Maximum repetitive off-state current	Q_{ge}	Gate emitter charge
$I_{D(RMS)}$	RMS output current	Q_{gs}	Gate source charge
I_{DSS}	Drain source leakage current	Q_r	Reverse recovery charge
I_F, I_T	Forward current	Q_{RM}	Reverse recovery charge (intrinsic diode)
		Q_s	Recovered charge to IRM

Symbols and Terms

RBSOA	Reverse Bias Safe Operating Area
$R_{DS(on)}$	Static drain source on resistance
R_{FI}	Radio frequency interference (= EMI)
R_G	Gate resistance
R_{GE}	Gate emitter resistance
rT	Slope resistance (for power loss calculation only)
$R_{thCK}; R_{thCH}$	Thermal resistance case to heatsink
R_{thJA}	Thermal resistance junction to ambient
R_{thJC}	Thermal resistance junction to case
$R_{thJK}; R_{thJH}$	Thermal resistance junction to heatsink
R_{thJS}	Thermal resistance junction to heatsink
R_{thJW}	Thermal resistance junction to water
R_{thKA}	Thermal resistance heatsink to ambient
SCSOA	Short Circuit Safe Operating Area
$T_{amb}; T_A$	Ambient (cooling medium) temperature
$T_C; T_{case}$	Case temperature
$t_{d(off)}$	Turn-off delay time
$t_{d(on)}$	Turn-on delay time
t_{fi}	Current fall time (inductive load)
t_{fr}	Forward recovery time
t_{FLT}	Overcurrent or short circuit trip delay time
t_{gd}	Gate controlled delay time
$T_J; T_{VJ}$	Virtual junction temperature
$T_{JM}; T_{VJM}$	Maximum virtual junction temperature
$T_K; T_H; T_S$	Heatsink temperature
T_L	Lead temperature
$T_{S(max)}$	Maximum allowable heatsink temperature
T_{stg}	Storage temperature
t_P	Pulse time
t_q	Turn-off time
t_r	Current rise time
t_{rr}	Reverse recovery time
t_{rv}	Rise time of collector emitter voltage
t_{SC}	Short circuit duration
V_{BO}	Breakover voltage
V_{CE}	Collector emitter voltage
$V_{CE(sat)}$	Collector emitter saturation voltage
$V_{CE(sat)FLT}$	Collector emitter saturation voltage to indicate fault
V_{CEK}	Collector emitter clamp voltage on chip level
V_{CES}	Collector emitter voltage
V_{CGR}	Collector gate voltage
V_{DD}	Module supply voltage
$V_{DD FLT}$	Module supply voltage without fault
V_{DGR}	Drain gate voltage
V_{DRM}	Maximum repetitive forward blocking voltage
V_{DS}	Drain source voltage

V_{DSM}	Max. non-repetitive forward blocking voltage
V_{DSS}	Drain source breakdown voltage
Version	Various construction designs of products
V_F	Forward voltage
V_{FLT}	Voltage at fault terminal
V_{FR}	Forward recovery voltage
V_{GD}	Gate non-trigger voltage
V_{GE}	Gate emitter voltage
$V_{GE(th)}$	Gate emitter threshold voltage
V_{GEM}	Maximum transient collector gate voltage
V_{GES}	Maximum DC gate voltage
V_{GS}	Gate source voltage
$V_{GS(th)}$	Gate threshold voltage
V_{GSM}	Maximum transient gate source voltage
V_{GT}	Gate trigger voltage
V_H	Holding voltage
V_{IN}	Input control voltage
$V_{IN(H)}$	Input voltage threshold for IGBT turn-on
$V_{IN(L)}$	Input voltage threshold for IGBT turn-off
V_{ISOL}	Isolation voltage
V_R	Reverse voltage
V_{RES}	Input voltage threshold for Reset = active
V_{RGM}	Maximum reverse gate voltage
V_{RRM}	Maximum repetitive reverse voltage
V_{RSM}	Maximum non-repetitive reverse voltage
VSD	Forward voltage drop
V_T	Forward voltage
V_{TO}	Threshold voltage (for power loss calculation)
Z_{thJC}	Transient thermal impedance junction to case
$Z_{thJK}; Z_{thJH}$	Transient thermal impedance junction to heatsink

Semiconductor Catalog, Edition 2015

© IXYS Corporation 2015
All Rights reserved

Note

As far as patents or other rights of third parties are concerned, liability is only assumed for components per se, not for applications, processes and circuits implemented with components or assemblies. The information describes the type of component and shall not be considered as assured characteristics.

Stress above one or more of the limiting values may cause permanent damage to the device. These are stress ratings only and operation of the device at these or at any other conditions above those given in the characteristics sections of the specification is not implied. Exposure to limiting values for extended periods may affect device reliability. Terms of delivery and rights to change design or specifications are reserved. Changes have been made to earlier published specifications. The data herein supersedes all previously published informations.

Life support applications

IXYS products used in life support appliances, devices, or systems where malfunction of these products can reasonably be expected to result in personal injury must be expressly authorized for such purposes.

CAPSULE DEVICES

W 0646 W C 15 0

W
M
F
E
N
R
P
K
A
S
H
G
Y

0646
*

W
Y
K
J
L
Q
D
N
M
P
V
H
Z
T
E
F
G

A
B
C
D
E
F
G
H
J
K
L
M
R

15

Device type

Rectifier diode
Fast/soft recovery diode
Extra fast diode
HP Sonic-FRD™
Phase control thyristor
Distributed gate thyristor
Fast turn-off thyristor
Medium voltage thyristor
Asymmetric thyristor
Symmetrical gate turn-off thyristor
Fast symmetrical gate turn-off thyristor
Asymmetric gate turn-off thyristor
Pulse Thyristor

Device nominal current rating

For devices exceeding 9999 Amperes, digit 5 of the part number changes to C (x100)

Electrode diameter

19mm
25mm
29mm
32mm
34mm
38mm
44mm
47mm
50mm
57mm
63mm
66mm/68mm
73mm
75mm
85mm
99mm
125mm

Housing type (electrode diameter in brackets)

26mm reverse build
8mm (D)
Standard outline - 14mm (W, Y), 16mm (K), 26mm (L, Q, M, T, E), 26.5mm (N), 33mm (V), 36mm (F, G), 37mm (Z)
21mm (N), 24mm (V, Z), 26mm (F, G)
35mm inverse build (T, M, Q, L)
19.5mm (L), 26mm (K, N, V), 35mm (6.5kV Sonic diode)
35mm (L, N)
14mm (N), 26mm (Y), slotted 32mm (V)
19.5mm (N), 25.8mm (V), 26mm (T)
Wespack 14.5mm (J, Q, M, H)
Wespack 26mm (Q, M)
Wespack 33mm (H)
Wespack 14mm (Q), 26mm (N)

Voltage grade - V_{RRM} VDRM/100

Special code

0 t_q code (thyristors), V_{RRM} % of V_{DRM} for Gate turn-off thyristors - See relevant tables
P PIN diode (Product groups: W, M, F, E)
R Rotating package (N, K, W)
A Avalanche rated diode (W)

t_q Code			
0	No code		
A	10	M	70
B	12	N	100
C	15	P	120
D	20	R	140
E	25	S	160
F	30	T	200
G	35	V	250
H	40	W	300
J	50	X	400
K	60	Y	500
L	65	Z	1000

V_{RRM} % of V_{DRM} for GTO's (S and H types only)	
0	100
D	80
Y	100 V

PRESS-PACK IGBT CAPSULE DEVICES

T	0240	N	B	45	E	
						Device type
T						Press-pack IGBT
	0240					Device pulse current rating
		N				Electrode diameter
		V				47mm
		H				63mm
		T				66mm
		E				75mm
		A				85mm
		D				96mm
		G				110mm
			B			125mm
			D			Die series
			F			
				45		Voltage grade - $V_{RRM}/100$
						Build description for multiple square die
					A	Reverse conducting
					E	Asymmetric
					G	Reverse Conducting (IGBT to diode ratio of 2:1)

STUD DEVICES

W	0508	S	A	04	0	
						Device type
W						Rectifier diode
N						Phase control thyristor
P						Fast turn-off thyristor
S						Symmetrical Gate turn-off thyristor
	0508					Device nominal current rating
		S				Device polarity
		R				Stud Anode
			C			Stud Cathode
			E			Package
			F			3/4" stud ceramic
			J			3/4" HV ceramic stud with lug
			M			3/4" HV ceramic stud
			R			1/2" ceramic stud with flag
						3/8" stud ceramic
						M20 stud ceramic with lug & gate leads
				04		Voltage grade - $V_{RRM}, V_{DRM}/100$
					0	tq code - See table for relevant code

All IXYS UK stud devices are available with or without leads, sleeving and nuts and washers

When ordering a stud based device, please add one of the following three-letter codes to the part number

- 000 – Ledded stud, no sleeving, no nuts and washers supplied (Default option)
- S0L - Ledded stud, with blue sleeving, nuts and washers supplied loose ('S' polarity studs only)
- R0L - Ledded stud, with red sleeving, nuts and washers supplied loose ('R' polarity studs only)
- 00L - Ledded stud, no sleeving, nuts and washers supplied loose
- NLL - Non-ledded stud, nuts and washers supplied loose
- S0F - Ledded stud, with blue sleeving, nuts and washers fitted ('S' polarity studs only)
- R0F - Ledded stud, with red sleeving, nuts and washers fitted ('R' polarity studs only)
- 00F - Ledded stud, no sleeving, nuts and washers fitted
- NLF - Non-ledded stud, nuts and washers fitted
- S00 - Ledded stud, with blue sleeving, no nuts and washers supplied ('S' polarity studs only)
- R00 - Ledded stud, with red sleeving, no nuts and washers supplied ('R' polarity studs only)
- NLS - Non-ledded stud, no sleeving, no nuts and washers supplied

NEW PACKAGES

Pressfit Pin for E2 and E3 Module Package

IXYS presents a new Press-Fit-Pin for E2 and E3 module packages. Modules equipped with those pins can be connected to the PCB without a further solder process. For the pressing process either hand tools or pressing machines can be used. Benefits for the assembly are:

- simplified process
- reduced mounting time
- no risk of bad solder contacts
- reduced aging of pin contact
- no thermal stress for the PCB assembly
- press out possible for maintenance

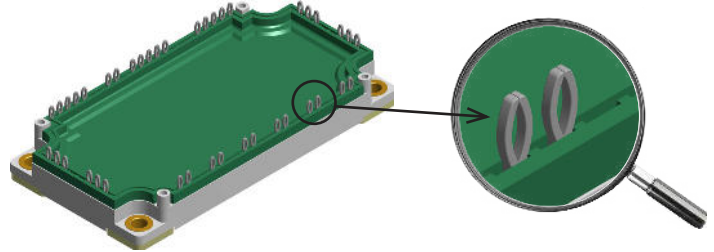

The pin concept is based on the proven „Bizon“-Pin concept.

Pressing process is a plastic deformation of pin and via of the board ending in a cold shut.

Pin features are:

- Pin concept based on successfully proven „Bizon“-Pin concept
- Pin qualification according to IEC 60352-5
- High conductive Cu alloy with Ni / gal. Tin surface
- Very low contact resistance
- Low press-in force per pin and PCB hole diameter independent press-out force
- Press-Fit-Pin usable for PCB's designed for competitor devices

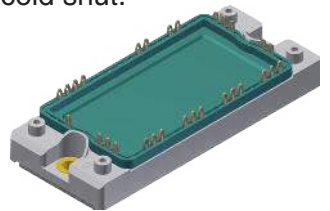

Board and Via Requirements			
	min.	typical	max.
Drill hole diameter		2.35 mm	
Final hole diameter	2.14 mm	2.20 mm	2.29 mm
Cu thickness inside the hole	>25 μm		
Metallization thickness in hole			<15 μm
Cu thickness for tracks	35 μm	70 μm 105 μm	
PCB thickness	1.60 mm	2.00 mm	
Metallization PCB	chem. Tin		

First planned modules are:



MIXG 120W1200PTEH
MIXG 180W1200PTEH

MCMA 240U11600PED
MDMA 210UB1600PTED
MDMA 280UB1600PTED
MDMA 360UB1600PTED

MDMA 660U1600PTEH
MDMA 900U1600PTEH
MDNA 660U2200PTEH

NEW High Voltage TO-247HV and PLUS247HV packages

- ✓ improved pin spacing for high potential
- ✓ creepage distance pins to copper of backside: > 5.7 mm
- ✓ creepage distance between high voltage pins (collector/emitter or drain/source): > 7.0 mm

Type	Technology	V _{CES} / V _{DSS} V	I _{C25} / I _{D25} A	V _{CEsat} V	R _{DS(on)} Ω	Fig. No.	
IXTH 1N170DHV	MOSFET	1700	1.0	-	16	X014c	X014c TO-247HV 
IXTH 1N200P3HV	Polar 3	2000	1.0	-	40		
IXTH 1N300P3HV	Polar 3	3000	1.0	-	50		
IXBH 10N300HV	BiMOSFET		34	2.8	-		
IXBH 14N300HV	BiMOSFET		38	2.7	-		
IXBH 22N300HV	BiMOSFET		60	2.7	-		
IXBX 28N300HV	BiMOSFET		32	2.7	-	X015c	X015c PLUS247HV 
IXBH 20N360HV	BiMOSFET	3600	70	3.4	-	X014c	
IXBX 50N360HV	BiMOSFET		125	2.9	-	X015c	
IXTH 02N450HV	MOSFET	4500	0.2	-	625	X014c	
IXTH 1N450HV	MOSFET		1.0	-	80		
IXYX 40N450HV	HV IGBT		35	3.9	-	X015c	

High Voltage TO-263 (D²-Pak) and TO-268 (D³-Pak) packages

- ✓ improved pin spacing (no middle pin)
- ✓ creepage distance pins to copper of backside:
 - 4.7 mm for new TO-263ABHV package
 - 5.8 mm for new TO-268AAHV package

Products in High Voltage TO-263 (D²-Pak) package

Diode	Technology	Config.	V _{RRM} V	I _{FAV} / I _{TAV} A	@ T _C °C
➤ New					
DMA 10P1600PZ	Standard	Phase leg	2x 1600	10	150
DMA 30IM1600PZ	Standard	Single	1600	30	140
DAA 10EM1800PZ	Avalanche	Single	1800	10	150
DAA 10P1800PZ	Avalanche	Phase leg	2x 1800	10	150
DMA 10P1800PZ	Standard	Phase leg	2x 1800	10	150
DNA 30E2200PZ	Standard	Single	2200	30	140
DNA 30EM2200PZ	Standard	Single	2200	30	140

FRED / HiPerFRED					
DSEI12-12AZ	FRED	Single	1200	11	100
DSEP12-12AZ	High Performance	Single		12	135
DSEP12-12BZ	High Performance	Single		15	130
Thyristor					
➤ CLA 5E1200PZ	High Efficiency	Single	1200	5	135
➤ CLA 30E1200NPZ	High Efficiency	Single		30	115
➤ CLB 30I1200PZ	HE Anode Gated	Single		30	115
➤ CMA 20E1600PZ	Standard	Single	1600	20	115
CMA 30E1600PZ	Standard	Single		30	115
➤ CME 30E1600PZ	Fast	Single		30	80
Triac					
➤ CLA 30MT1200NPZ	High Efficiency	Triac	1200	15	120
➤ CLA 40MT1200NPZ	High Efficiency	Triac		20	115

X011c

TO-263ABHV



Creepage (min):

pin/pin: 4.0 mm
pin/Cu back-side: 4.7 mmFor more details see
outline drawings

IGBT & BiMOS	Technology	Config.	V _{CES} V	I _{C25} A	V _{CEsat} V
◇ under development					
IXXA 30N65C3HV	GenX3™ XPT IGBT	Single	650	52	2.2
◇ IXA 4IF1200PZ	XPT IGBT	Copack	1200	9	1.8
◇ IXA 20I1200PZ	XPT IGBT	Single		38	1.8
➤ IXYA 20N120C3HV	Fast XPT IGBT	Single	1200	40	3.4
➤ IXGA 20N250HV	High Voltage NPT IGBT	Single	2500	30	3.1
➤ IXBA 16N170AHV	High Voltage BiMOS	Single	1700	16	6.0
➤ IXBA 10N300HV	High Voltage BiMOS	Single	3000	34	2.8
IXBA 12N300HV	High Voltage BiMOS	Single		30	3.2
➤ IXBA 14N300HV	High Voltage BiMOS	Single		38	2.7

MOSFET	Technology	Config.	V _{DSS} V	I _{D25} A	R _{DSon} Ω
➤ New					
➤ IXTA 05N100HV	High Voltage MOSFET	Single	1000	0.75	17
➤ IXTA 08N100D2HV	Depletion Mode MOSFET	Single		0.8	21
IXTA 3N100D2HV	Depletion Mode MOSFET	Single		3.0	6
➤ IXTA 3N120HV	High Voltage MOSFET	Single	1200	3.0	4.5
➤ IXTA 3N150HV	High Voltage MOSFET	Single	1500	2.0	7.3
➤ IXTA 4N150HV	High Voltage MOSFET	Single		4.0	6
➤ IXTA 1N170DHV	High Voltage MOSFET	Single	1700	1.0	1
➤ IXTA 1N200P3HV	High Voltage MOSFET	Single	2000	1.0	40
IXTA 02N250HV	High Voltage MOSFET	Single	2500	0.2	450

Products in High Voltage TO-268 (D³-Pak) package

Rectifier	Technology	Config.	V _{RRM} V	I _{DAV} / I _{TAV} A	@ T _c °C
➤ New					
DSP 45-12AZ	Standard	Phase leg	2x 1200	45	130
DSP 45-16AZ	Standard	Phase leg	2x 1600	45	130
Triac					
CLA 60MT1200NTZ	High Efficiency	Triac	1200	30	120
➤ CMA 60MT1600NHR	Standard	Triac	1600	66	90
Thyristor					
CMA 50E1600TZ	Standard	Single	1600	50	110

IGBT & MOSFET	Technology	Config.	V _{CES} / V _{DSS} V	I _{C25} / I _{D25} A	V _{CEsat} V	R _{DSon} Ω
➤ New						
IXYT 30N65C3H1HV	GenX3™ XPT IGBT	Single	650	60	2.7	
IXYT 20N120C3D1HV	GenX3™ XPT IGBT	Single	1200	36	3.4	
IXGT 25N250HV	High Voltage NPT IGBT	Single	2500	60	2.9	
➤ IXYT 30N450HV	High Voltage IGBT	Single	4500	60	3.9	
➤ IXBT 16N170AHV	High Voltage BIMOS	Single	1700	16	6.0	
IXBT 12N300HV	High Voltage BIMOS	Single	3000	30	3.2	
IXBT 20N300HV	High Voltage BIMOS	Single		20	3.2	
➤ IXBT 22N300HV	High Voltage BIMOS	Single		60	2.7	
IXBT 42N300HV	High Voltage BIMOS	Single		104	3.0	
➤ IXBT 20N360HV	High Voltage BIMOS	Single	3600	70	3.4	
➤ MCB 60I1200TZ	SiC MOSFET	Single	1200	90		0.034
➤ IXTT 4N150HV	High Voltage MOSFET	Single	1500	4		6
➤ IXTT 12N150HV	High Voltage MOSFET	Single		12		2
IXTT 1N250HV	High Voltage MOSFET	Single	2500	1.5		40
➤ IXTT 1N300P3HV	High Voltage MOSFET	Single	3000	1		50
IXTT 02N450HV	High Voltage MOSFET	Single	4500	0.2		625
IXTT 1N450HV	High Voltage MOSFET	Single		1		80

X019a **TO-268AAHV**



Creepage (min):
pin/pin: 9.4 mm
pin/Cu back-side: 5.8 mm
For more details see
outline drawings

ISO247 package (ISOPLUS Technology with Screw Hole)

- ✓ 3000V isolation
- ✓ Excellent thermal performance
- ✓ 100% mechanical fit to TO-247

Diode	Technology	Configuration	V _{RRM} V	I _{DAV} / I _{TAV} A	@ T _c °C
➤ New					
DSA 90C200HR	Schottky Diode	Common Cathode	200	2x 45	145
➤ DMA 50P1200HR	Standard	Phase leg	2x 1200	50	105
➤ DMA 30P1600HR	Standard	Phase leg	2x 1600	30	105
Thyristor					
➤ CLA 40E1200HR	High Efficiency	Single	1200	40	95
➤ CMA 40E1600HR	Standard	Single	1600	40	90
Triac					
➤ CLA 40MT1200NHR	Thyristor	Triac	1200	20	110
CLA 60MT1200NHR	Thyristor	Triac		30	100
➤ CLA 80MT1200NHR	Thyristor	Triac		40	100

IGBT & MOSFET	Technology	Config.	V _{CES} / V _{DSS} V	I _{C25} / I _{D25} A	V _{CEsat} V	R _{DSon} Ω
➤ New						
IXFJ 26N50P3	Polar3™ HiperFET™	Single	500	14		0.265
IXGJ 50N60C4D1	High Gain IGBT	Copack	600	52	2.5	
➤ MKH 24I650HR	CoolMOS™ CFD	Single	650	25		0.08
IXYJ 20N120C3D1	Gen X3 XPT IGBT	Single	1200	21	3.4	
➤ IXYJ 30N120C3D1	Gen X3 XPT IGBT	Single		32	3.3	
➤ IXTJ 3N150	High Voltage MOSFET	Single	1500	2.3		8.0
➤ IXTJ 4N150	High Voltage MOSFET	Single		2.5		6.0
➤ IXTJ 6N150	High Voltage MOSFET	Single		3.0		3.85

X016c **ISO247™**

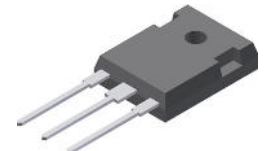

ISOPLUS-SMPD™

ISOPLUS-DIL™

ISOPLUS i4-PAC™

ISOPLUS264™

ISO247™

ISOPLUS247™

ISOPLUS220™

Isolated Discrete Packages

ISOPLUS247™ is the DCB isolated version of the PLUS247™ package (TO-247 without a mounting hole). The design of this patented package is revolutionary: the silicon chip is soft soldered onto a Direct Copper Bond (DCB) substrate instead of the usual copper lead frame. The DCB ceramic, the same substrate material as used in the high power modules, not only provides high isolation capability (2500 V_{RMS}) but also unbeatable low thermal resistance compared to conventional, externally mounted isolation materials.

Advantages:

- Isolation capability from leads to back-side 2500 V_{RMS} – no external isolation foil needed
- Thermal resistance from Junction to Case only slightly higher as for non-isolated version
- Increased power- and temperature cycling capability
- DCB can be patterned like printed circuit boards – allowing special functions to be realized

types available.

Another interesting feature is the capability to pattern the DCB substrate like a printed circuit board. Now additional special functions can be realized, e.g. the **series connection of single** diode chips within one package.

ISOPLUS220™, ISOPLUS247™ and ISOPLUS264™ are the DCB substitutes for the corresponding standard packages.

A larger version of this packaging technology is named **ISOPLUS i4-PAC™**. It has up to five terminal pins, making it possible to build up full diode bridges, phase-leg transistor configurations, buck and boost converters and much more within one isolated discrete package.

Package cross section

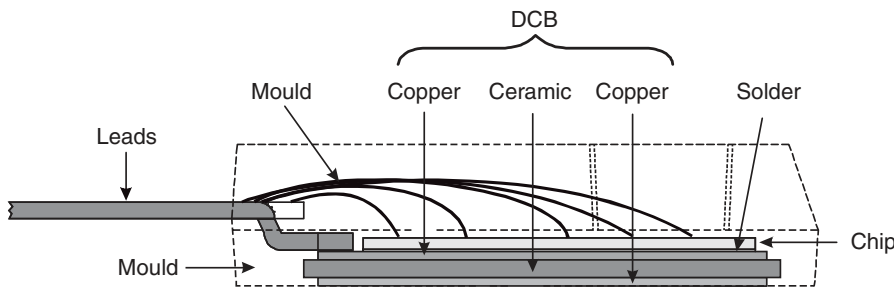

While the junction-to-case thermal resistance is higher than an equivalent, non-isolated device, what really matters is the total thermal resistance from junction-to-heatsink ($R_{th,H}$). Comparing a device in ISOPLUS247™ to its companion in the non-isolated package with an external isolation foil, one can see that the overall R_{th} is now lower for the part in the already isolated package (see example).

Due to the matched thermal expansion coefficients of silicon and DCB ceramic, mechanical stress to the die and solder caused by power and temperature

cycling is reduced so that reliability is improved. Mounting is done with clips, which not only saves time but also guarantees constant pressure force over the whole lifetime of the assembly.

Parts in the **ISOPLUS247™** housing can be identified by the letter "R" in the IXYS part number. Potentially all devices now encapsulated in TO-247, TO-264 and PLUS247™ housings can be molded in the ISOPLUS247™. There are already more than 100 different ISOPLUS247™

ISOPLUS-DIL™ 37.5 mm long and 25 mm wide provides the largest mounting area within the ISOLPLUS™ family. It is available in 2 pin out version: „GWM“ configuration with power pins for 300 A RMS on one side and 12 control pins on the opposite side and the „GMM“ configuration with 12 pins on either side. The package is intended for high current low voltage (< 200 V) applications either as single switch or 6-pack. With highest power density and high reliability ISOPLUS-DIL™ is recommended for the use in automotive designs.

ISOPLUS-SMPD™ is the latest member of IXYS ISOPLUS™ family and provides an increased creepage distance between pins to DCB (>4 mm) and pin to pin (up to 7 mm).

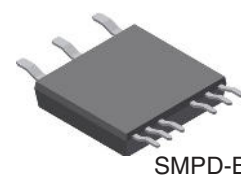

SMPD-B

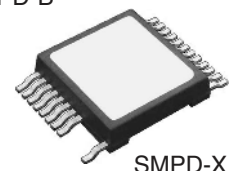

SMPD-X

Example: ISOPLUS247™ compared to conventional isolated device

Type	Package	Isolation	R_{thJC} K/W	R_{thCK} K/W	Total K/W	Factor
IXFR 180N10	ISOPLUS247™	internal DCB	0.3	0.15	0.45	1
IXFX 180N10	PLUS247™	external foil	0.22	1.02	1.24	2.8

DCB isolated SMPD package for simplified mounting and high circuit flexibility

Reducing assembly costs is a continual demand of the semiconductor user. One of the various approaches is the usage of SMD packages which is successfully introduced by utilization of Power Semiconductors packaged in TO-263 (D²Pak) or TO-268 (D³Pak). If heat sinking is required designers have to look for solutions providing isolation and creepage distance.

ISOPLUS-SMPD™ package is the IXYS answer to the challenge to make designer's life easier as it provides an SMD device featuring:

- 2.5 kV isolation to heatsink (UL rating)
- low thermal impedance for good cooling by only 0.38 mm thick ceramic
- more than 4 mm creepage distance from pin to mounting surface
- up to 7 mm creepage from pin to pin (depending on package type)
- high integration such as phase leg or 3~ input rectifier in one package
- automatic mounting by pick & place possible (packaged in Tape & Reel)

This enables the engineer to make flat designs with a concept of distributed power dissipation. The latter allows utilization of heatsinks with a thinner base reducing weight and cost.

The new ISOPLUS-SMPD™ package is small and light weight with two rows of pins, resembling an IC. It allows the assembly to the board in standard SMD pick & place equipment, together with other standard SMD components. ISOPLUS-SMPD™ devices are available in Tape & Reel or in a Blister Tray option.

The complete board including the power components can run through a standard SMD soldering process.

Two types are available, ISOPLUS-SMPD™-B (Fig. 1) is optimized for implementing more complex configurations like phase-legs, buck and boost chopper as well as single – or 3-phase input rectifier bridges, which can ideally be used as building blocks for inverters. ISOPLUS-SMPD™-X (Fig. 2) with a larger number of pins on either side allows the integration of large dies for very high current capability up to 600 A per unit.

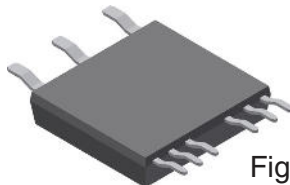

Fig. 1 SMPD-B

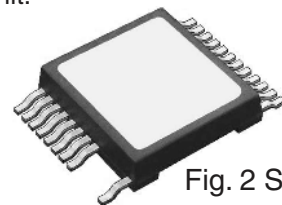

Fig. 2 SMPD-X

Both designs benefit from the ISOPLUS™ construction with low mechanical stress for the die because of a good match in the thermal expansion coefficient of die and DCB resulting in long term reliability.

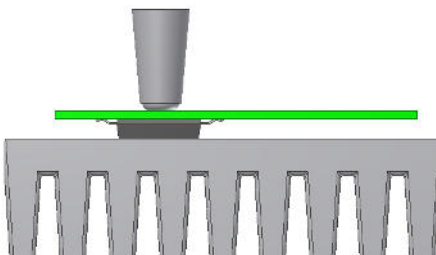

Fig. 3 Mounting example

As normal these devices require a layer of thermal interface material (heat transfer paste) to be applied to the backside of the power devices (or to the heat sink surface alternatively). Then the devices can be mounted together with the PCB to a heat sink.

These power devices need to be pressed down to the heat sink to ensure low thermal resistances. Pressure can be applied in different ways, for example using a mounting clip or a post, applying pressure via the PCB directly to the power device (see Fig. 3 and Fig. 4).

The high package flexibility allows to offer

- high current single Trench MOSFET
- high current single IGBT
- buck and boost converters
- phase-legs with desaturation diodes for switch control
- 1~ or 3~ input rectifiers
- multiple boost stages
- cascade configurations

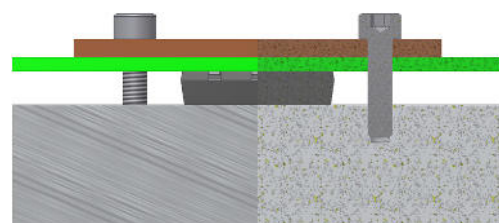
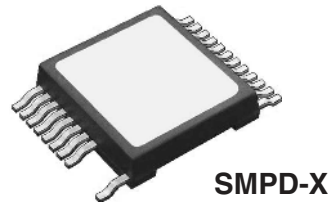
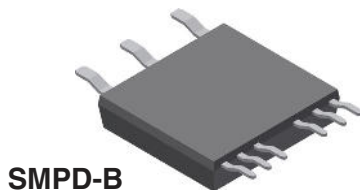

Fig. 4 Mounting example

Customer specific designs are feasible.

IGBT Modules – SMPD Converter Building Blocks

ISOPLUS™ Technology



- 2500 V UL rated electrical isolation
- low thermal resistance
- increased power & temperature cycling
- saves space

- replaces multiple discretes
- reduces parasitic inductance & capacitance
- reduces EMI
- heat spreading

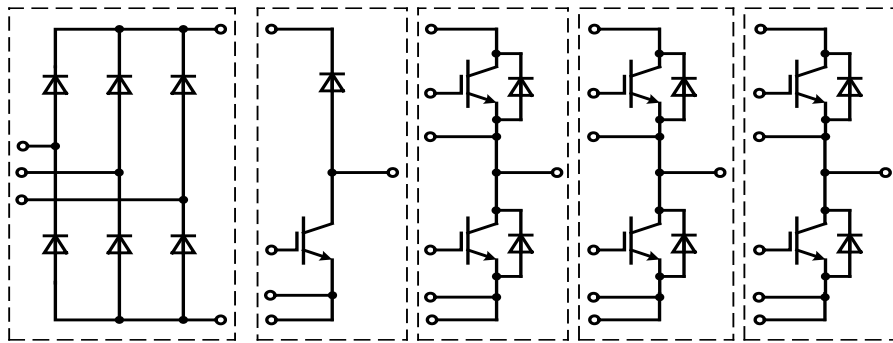

Rectifier

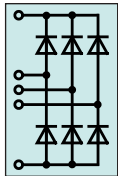

Line Rectifier
DMA90U1800LB
SONIC-FRD
DHG60U1200LB

Brake & Boost

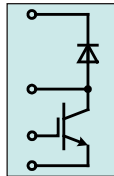

XPT-IGBT
IXA20RG1200DHGLB
IXA30RG1200DHGLB
IXA40RG1200DHGLB

Inverter

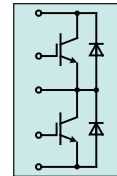

XPT-IGBT
IXA20PG1200DHGLB
IXA30PG1200DHGLB
IXA40PG1200DHGLB
ITF40PF1200DHGTLB

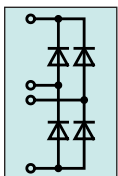

Line Rectifier
DLA100U1200LB
DLA100U800LB
Fast Rectifier
DPG60B600LB HiPerFRED
DCG20B650LB SiC
DHG50B1200LB SONIC
DCG20B1200LB SiC

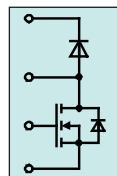

CoolMOS™ Boost
MKE38RK600DFELB & FRED Diode
MKG40RK600LB & SONIC Diode
MKH17RP650DCGLB Dual Boost & SiC

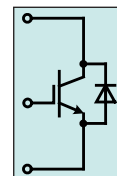

XPT-IGBT
MMIX1X100N60B3H1
MMIX1X200N60B3H1
MMIX1Y82N120C3H1
MMIX1Y100N120C3H1
IXA60IF1200DHGLB
IXA80IF1200DHGLB

MOSFETs

Type	Circuit diagram / Technology	V _{DSS}	I _{D25} T _C = 25°C	R _{DS(on)} max. T _C = 25°C	Q _G	Fig. No.	Circuit Diagram
➤ New ◇ under development		V	A	mΩ	nC		
SINGLE							
MMIX 1T600N04T2	A Trench2	40	600	1.3	590	X031a	
MMIX 1T550N055T2	A Trench2	55	550	1.3	595		
MMIX 1F520N075T2	A Trench2 HiPerFET™	75	500	1.6	545		
MMIX 1F420N10T	A Trench HiPerFET™	100	334	2.6	670		
MMIX 1F360N15T2	A Trench2 HiPerFET™	150	235	4.4	715		
MMIX 1F230N20T	A Trench HiPerFET™	200	168	8.3	378		
MMIX 1F180N25T	A Trench HiPerFET™	250	132	13	364		
MMIX 1F160N30T	A Trench HiPerFET™	300	102	20	376		
MMIX 1F210N30P3	A Polar3 HiPerFET™		108	16	286		
MMIX 1F132N50P3	A Polar3 HiPerFET™	500	63	43	250		
MMIX 1F44N100Q3	A Q3 HiPerFET™	1000	30	245	264		
MMIX 1F40N110P	A Polar HiPerFET™	1100	24	290	310		
BUCK / BOOST							
MKE 38RK600DFELB	C CoolMOS™ CP & FRED	600	50	40	150	X030a	
➤ MKG 40RK600LB	C CoolMOS™ C6 & SONIC		52	37	290		
◇ MKH 17RP650DCGLB	Y Dual CoolMOS™ CFD & SiC		22	110	118		
PHASE-LEG							
➤ MMIX 2F150N20T	B Trench™ HiPerFET™	200	84	16.5	177	X031a	
➤ MMIX 2F94N30T	B Trench™ HiPerFET™	300	52	40	305		
➤ MMIX 2F60N50P3	B Trench™ HiPerFET™	500	30	110	96		
MKE 38P600LB	B CoolMOS™ CP	600	50	40	150	X030a	
◇ MKH 22P650LB	B CoolMOS™ CFD	650	31	80	170		
◇ MKH 40P650LB	B CoolMOS™ CFD		57	41	300		

CoolMOS™ is a trademark of Infineon Technologies

Outline drawings on
pages O-31...O-52

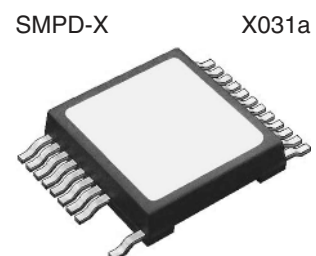
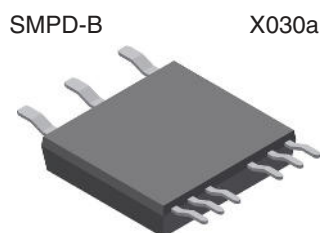

See data sheet for pin arrangement

IGBTs

Type	Circuit Diagram No. / Technology	V_{CES}	I_{C25} $T_C = 25^\circ\text{C}$	$V_{CE(sat)}$ typ. $T_C = 25^\circ\text{C}$	E_{off} typ. $T_J = 150^\circ\text{C}$ (125°C) mJ	Fig. No.	Circuit Diagram
➤ New ✧ under development		V	A	V			
SINGLE and COPACK							
MMIX 1X200N60B3	D XPT	600	223	1.4	3.45	X031a	
MMIX 1X100N60B3H1	E XPT & SONIC		145	1.5	2.80		
MMIX 1X200N60B3H1	E XPT & SONIC		175	1.4	3.45		
✧ IXA 100XF650LB	2xE 2 x XPT	650	2x 72	1.8	1.20	X030a	
➤ MMIX 1X340N65B4	D XPT™ IGBT GenX4™		450	1.4	2.54	X031a	
MMIX 1Y82N120C3H1	E XPT fast & SONIC	1200	78	2.9	(3.70)	X030a	
MMIX 1Y100N120C3H1	E XPT fast & SONIC		92	2.9	3.55		
✧ IXA 60IF1200DHGLB	E XPT & SONIC		85	1.8	5.5	X030a	
✧ IXA 85IF1200DHGLB	E XPT & SONIC		120	1.8	8.3		
MMIX 1G120N120A3V1	E GenX3 IGBT @ SONIC		110	1.85	58	X031a	
MMIX 1G75N250	D IGBT for cap discharge	2500	110	2.5	-		
➤ MMIX 1B15N300C	E BiMOSFET™	3000	37	4.7	-		
➤ MMIX 1B20N300C	E BiMOSFET™		50	4.5	-		
BOOST							
IXA 20RG1200DHGLB	I XPT & SONIC	1200	32	1.8	1.7	X030a	
IXA 30RG1200DHGLB	I XPT & SONIC		43	1.9	3.0		
IXA 40RG1200DHGLB	I XPT & SONIC		63	1.85	4.1		
PHASE-LEG							
IXA 20PG1200DHGLB	G XPT & SONIC	1200	32	1.8	1.7	X030a	
IXA 30PG1200DHGLB	G XPT & SONIC		43	1.9	3.0		
IXA 40PG1200DHGLB	G XPT & SONIC		63	1.85	4.1		
✧ ITF 40PF1200DHGTLB	H Trench IGBT & SONIC & NTC		56	2.05	2.6		
✧ ITF 40PG1200DHGLB	G Trench IGBT & SONIC		56	2.05	2.6		
➤ IXA 20PT1200LB	K XPT & Thyristor		28	1.8	1.7		
FULL-BRIDGE							
MMIX 4G20N250	L IGBT for cap discharge	2500	23	3.1 max	-	X031b	
➤ MMIX 4B22N300	L BiMOS		38	2.2	-		

SMPD-Y

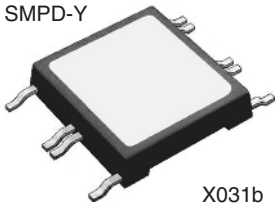

X031b

Outline drawings on
pages O-31...O-52

SMPD-B

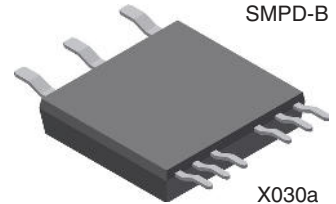

X030a

SMPD-X

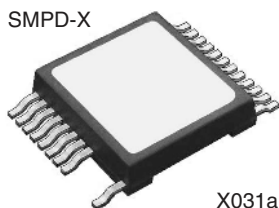

X031a

SMPD-Y

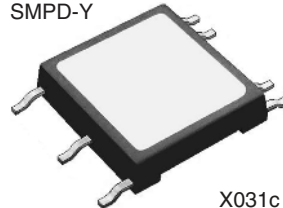

X031c

Diodes

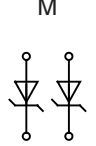
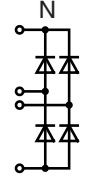
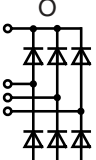
Type ➤ New ◇ under development	Circuit diagram / Diode type	V_{RRM} V	$I_{D(AV)M}$ A	@ T_C °C	Fig. No.	Circuit Diagram
DUAL						
DSA 120X150LB	M Schottky	150	2 x 60	150	X030a	
DSA 120X200LB	M Schottky	200	2 x 60	150		
1~ BRIDGE						
DPG 60B600LB	N HiPerFRED	600	60	110	X030a	
➤ DCG 20B650LB	N SiC	650	20	*		
➤ DLA 100B800LB	N Rectifier	800	124	135		
DLA 100B1200LB	N Rectifier	1200	124	80		
◇ DHG 40B1200LB	N SONIC		40	*		
◇ DHG 50B1200LB	N SONIC	50	*			
◇ DCG 20B1200LB	N SiC	20	*			
3~ BRIDGE						
DHG 60U1200LB	O SONIC	1200	62	80	X030a	
DMA 90U1800LB	O Rectifier	1800	99	80		

* in progress

Thyristors, Triacs

Type ➤ New ◇ under development	Circuit diagram / Bipolar type	V_{RRM} V	I_{TAV} A	@ T_C °C	Fig. No.
DUAL					
◇ CLA 60MU1200LB	2 x P Triac	1200	2 x 30	100	X030a
PHASE-LEG					
◇ CMA 50P1600LB	Q Thyristor	2x 1600	50	90	

MOS-Gated Thyristors

Type	V_{DM}	I_{TSM} 1μs $T_C = 25^\circ C$	I_{TSM} 10μs $T_C = 25^\circ C$	r_T typ	V_T max	$Q_{g(on)}$ typ	t_{ri} typ $T_C = 25^\circ C$	$V_{GK(th)}$ max	Circuit Diagram	Fig. No.
➤ New	V	kA	kA	mΩ	V	nC	ns	V		
➤ MMJX 1H40N150	1500	15.5	6.4	1.2	6	99	100	5	R	X032
➤ MMIX 1H60N150V1	1500	32.0	11.8	1.2	6	180	100	5	S	X031a

Outline drawings on pages O-31...O-52

SMPD-B X030a

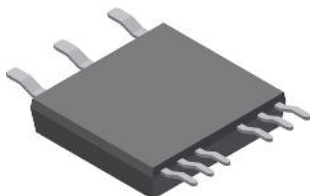

SMPD-X

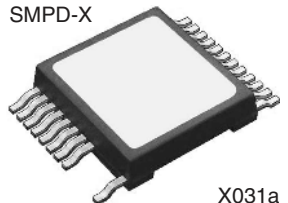

X031a

See data sheet for pin arrangement

MiniSMPD

X032

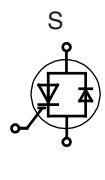
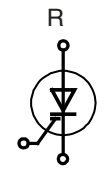
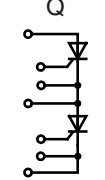
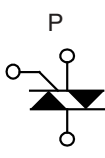
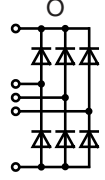
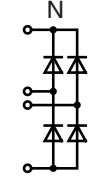
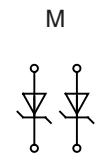

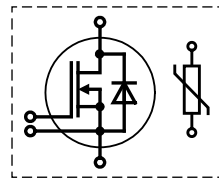

MTC...X...TGD

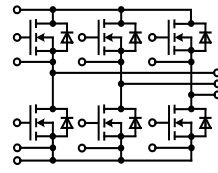

MTI..W...GC

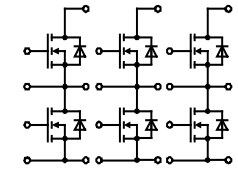

MTI...WX...GD / GMM

Single high current Switch with NTC

Type	V_{DSS}	I_{D25} $T_C = 25^\circ C$	I_{D90} $T_C = 90^\circ C$	$R_{DS(on)}$ typ. $T_J = 25^\circ C$	C_{iss} typ	Q_g typ	R_{thJC}	Fig. No.
◇ under development					typ	typ		
➤ new	V	A	A	mΩ	nF	nC	K/W	
◇ MTC 960X55TGD	55	2x 640	2x 480	1.1	2x 40	2x 595	0.16	X026d
◇ MTC 840X75TGD	75	2x 550	2x 420	1.3	2x 40	2x 545	0.16	

Six-Pack Trench MOSFET

Type	V_{DS} max.	I_{D25} $T_C = 25^\circ C$	I_{D90} $T_C = 90^\circ C$	$R_{DS(on)}$ typ. $T_C = 25^\circ C$	C_{iss} typ	Q_g typ	R_{thJC}	Fig. No.
◇ under development					typ	typ		
➤ New	V	A	A	mΩ	nF	nC	K/W	
➤ MTC 120W55GC	55	160	120	2.2	7.0	110	1.00	X026c
MTI 85W100GC	100	110	83	3.2	6.3	90	1.45	

Six-Pack 3x phaseleg

➤ MTC 120WX55GD	55	160	120	2.2	7.0	110	1.00	X026d
➤ MTC 120WX75GD	75	160	120	2.2	10.5	178	0.80	
MTI 200WX75GD	75	265	200	1.1	10.8	155	0.85	
MTI 145WX100GD	100	190	145	1.7	11.0	155	0.85	
GMM 3x60-015X2	150	50	38	19.0	5.8	97	1.00	

Customized configurations possible

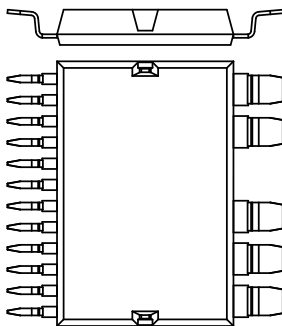

MTI...W...GC
SURFACE MOUNT DEVICE

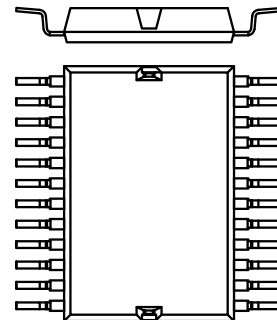

MTI...WX...GD; MTC...X...TGD; GMM...
SURFACE MOUNT DEVICE

Outline drawings on
pages O-31...O-52

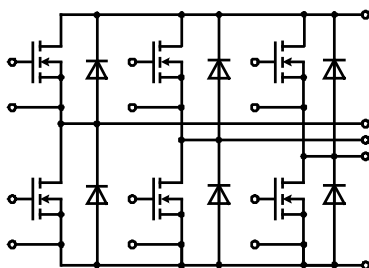

X026c ISOPLUS-DIL™

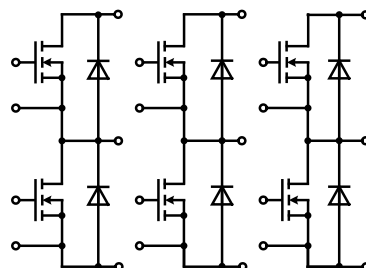

X026d ISOPLUS-DIL™

ISOPLUS™ i4-PAC™

3, 4 and 5 leaded packages for various circuit topologies

DCB base plate - 2500 V electrical isolation

- low thermal resistance
- increased power & temperature cycling
- saves space
- replaces multiple discretes
- reduces parasitic inductance and capacitance
- reduces EMI
- less weight

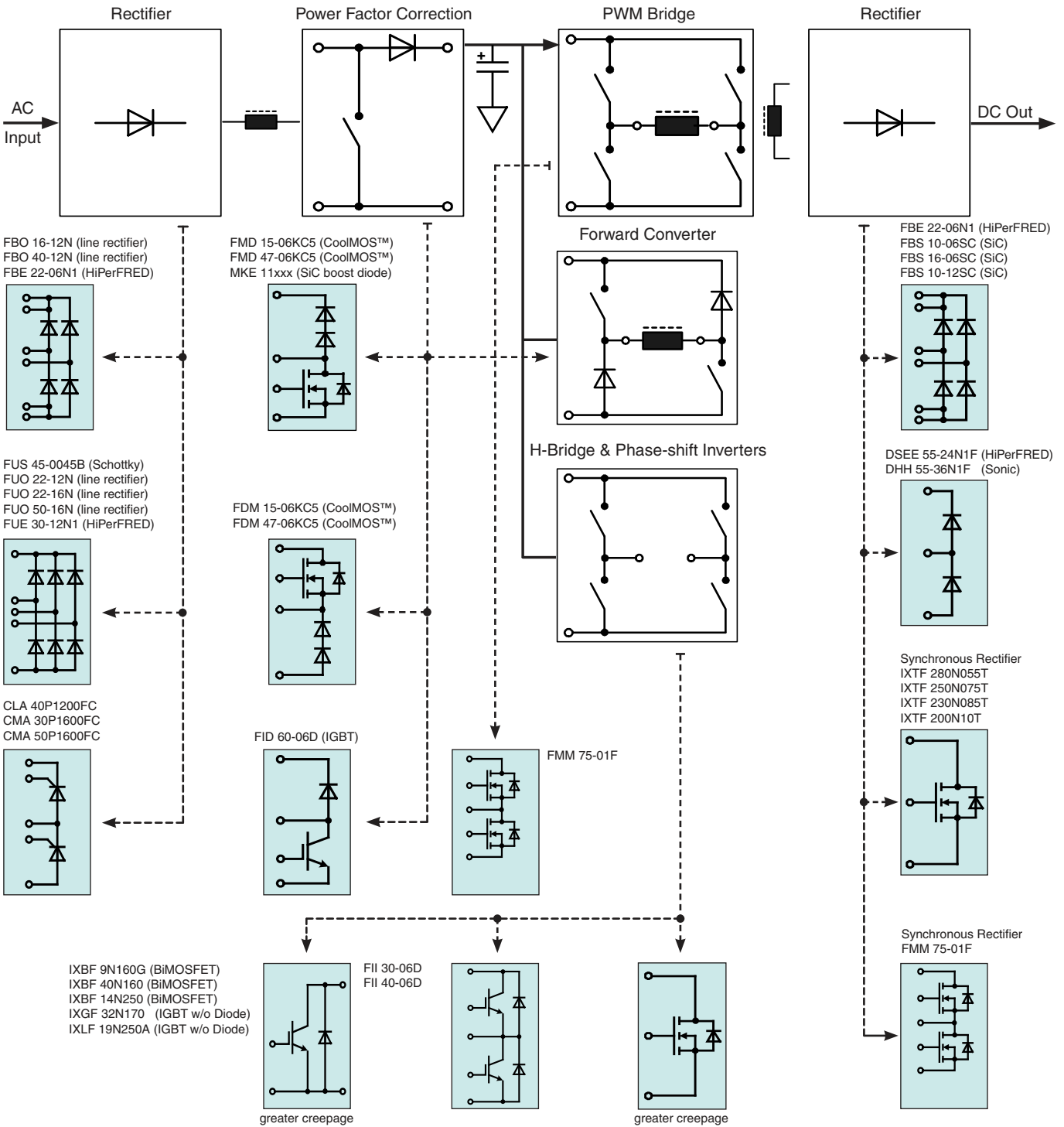
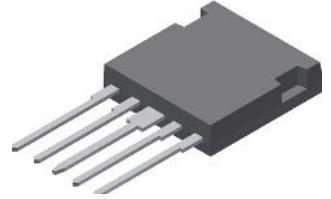

See application note „Combining the features of modules and discretes in a new Power Semiconductor packages“ for general description of the packaging technologies.

See alphanumeric index for the page number of the particular product.

IGBTs / MOSFETs

Type	Configuration	Circuit diagram / Technology	V _{DSS}	I _{D25} T _C = 25°C	I _{D90} T _C = 90°C	R _{DS(on)} typ. T _C = 25°C	Fig. No.	Circuit Diagram	
○ Not for new design ➤ New			V	A	A	mΩ			
IXTF 200N10T	single	A Trench MOSFET	100	90	*	70	X024d		
IXKF 40N60SCD1		G CoolMOS™ & serial Schottky & HiPerFRED free wheeling Diode	600	41	29	60	X024a		
IXKF 40N60SCH1		G CoolMOS™ & serial Schottky & SONIC free wheeling Diode		41	29	60			
IXTF 1N250		A High Voltage MOSFET	2500	1	*	40Ω	X024c		
IXTF 02N450		A High Voltage MOSFET	4500	0.2	*	750Ω			
IXTF 1N450		A High Voltage MOSFET		0.9	*	85Ω			
FDM 47-06KC5	buck	E CoolMOS™ & HiPerDynFRED	600	47	32	40	X024a		
○ FMD 21-05QC	boost	E HiPerFET & HiPerDynFRED	500	21	15	180			
MKE 11R600DCGFC		C CoolMOS™ & SiC Diode	600	15	11	150			
FMD 15-06KC5		D CoolMOS™ & HiPerDynFRED		15	11	150			
FMD 40-06KC		D CoolMOS™ & HiPerDynFRED		38	25	60			
FMD 47-06KC5		D CoolMOS™ & HiPerDynFRED		47	32	40			
FMM 150-0075X2F	phase leg	B Trench MOSFET	75	120	90	5.8			
FMM 75-01F		B HiPerFET	100	75	55	25			
FMP 76-010T ①		L Trench™ P & N-Channel	±100	-54 / 62	*	24 / 11			
FMP 36-015P ①		L Polar™ P & N-Channel	±150	-22 / 36	*	110 / 40			
FMP 26-02P ①		L Polar™ P & N-Channel	±200	-17 / 26	*	170 / 60			
FMM 60-02TF		B Trench HiPerFET	200	33	-	40			
FMM 50-025TF		B Trench HiPerFET	250	30	-	50			
FMM 22-05PF		B PolarHV™ HiPerFET	500	13	-	270			
FMM 22-06PF		B PolarHV™ HiPerFET	600	12	-	350			

Type	Configuration	Circuit diagram / Technology	V _{CES}	I _{C25} T _C = 25°C	I _{C90} T _C = 90°C (110°C)	V _{CE(sat)} typ. T _C = 25°C	Fig. No.
			V	A	A	mΩ	
IXBF 9N160G	single	I BiMOSFET	1600	7	4	4.9	X024c
IXBF 40N160		I BiMOSFET		28	16	6.2	
IXGF 32N170		H High voltage IGBT	1700	44	(19)	max 3.5	
IXGF 20N250		H High voltage IGBT	2500	23	14	max 3.1	
IXGF 25N250		H High voltage IGBT		30	15	max 2.9	
IXLF 19N250A		H High voltage IGBT		32	19	max 3.9	
IXGF 20N300		H High voltage IGBT		22	(14)	max 3.2	
IXBF 12N300		I BiMOSFET	3000	26	(11)	2.8	
IXGF 25N300		H High voltage IGBT		27	(16)	max 3.0	
➤ IXBF 14N300		I BiMOSFET		28	14	2.2	
IXBF 20N300		I BiMOSFET		34	(14)	2.7	
IXGF 36N300	H High voltage IGBT		36	18	max 2.7		
➤ IXBF 15N300C	I BiMOSFET		37	(15)	4.7		
➤ IXBF 22N300	I BiMOSFET		38	22	2.2		
IXBF 32N300	I BiMOSFET		40	22	2.8		
➤ IXBF 28N300	I BiMOSFET		50	28	2.3		
IXBF 42N300	I BiMOSFET		60	(24)	2.5		
IXBF 55N300	I BiMOSFET		86	(34)	2.7		
➤ IXBF 20N360	I BiMOSFET	3600	45	(18)	2.9	X024a	
➤ IXBF 50N360	I BiMOSFET		92	(28)	2.4		
IXGF 30N400	H High voltage IGBT	4000	30	15	max 3.1		
FID 60-06D	boost	K NPT IGBT & HiPerFRED	600	65	40		1.6
FII 30-06D	phase leg	J NPT IGBT	600	30	18	1.9	X024a
FII 40-06D		J NPT IGBT		40	25	1.8	

* in progress

CoolMOS™ is a trademark of Infineon Technologies

① high side switch: p-channel; low side switch: n-channel

Outline drawings on pages O-31...O-52

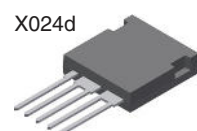
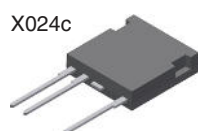
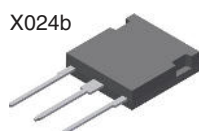

X024a

X024b

X024c

X024e

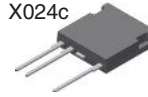
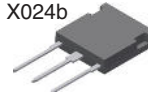

Bipolar

Type	Configuration	Circuit diagram / Diode type	Voltage V	$I_{D(AV)M}$ $T_c = 90^\circ\text{C}$ A	Fig. No.	Circuit Diagram
➤ New						
CS 20-22moF1	single part. high voltage	S Thyristor	2200	18	X024c	
➤ CNA 30E2200FB		S Thyristor		30	X024e	
DNA 30E2200FE		T Rectifier		30		
CS 20-25mo1F		S Thyristor		2500	18	
CLA 40P1200FC	phase leg	R Thyristor	2x 1200	40	X024a	
DSEE 55-24N1F		M HiPerFRED		55	X024b	
CMA 30P1600FC		R Thyristor	2x 1600	30	X024a	
CMA 50P1600FC		R Thyristor		50		
DHH 55-36N1F	M Sonic-FRD	2x 1800	50	X024b		
FBS 10-06SC	1-phase bridge	N Si-Carbide	600	6.6	X024a	
FBS 16-06SC		N Si-Carbide		11		
FBE 22-06N1		O HiPerFRED		20		
FBS 10-12SC		N Si-Carbide		1200		10
FBO 16-12N	O Rectifier	1200	22			
FBO 40-12N	O Rectifier		40			
FUS 45-0045B	3-phase bridge	Q Schottky	45	45		
FUO 22-12N		P Rectifier	1200	27		
FUE 30-12N1		P HiPerFRED	1600	30		
FUO 22-16N		P Rectifier	1600	27		
FUO 50-16N	P Rectifier	50				



Insulated Gate Bipolar Transistors (IGBT)

The Insulated Gate Bipolar Transistor (IGBT) is a three terminal device combining high efficiency with fast switching capabilities. IXYS offers various IGBT technologies optimized for the many topologies, circuits and requirements in today's varied power semiconductor applications. As a guide to the multiple technologies of IGBT on offer from IXYS please refer to the following characteristics.

$V_{CE(sat)}$ – a measure of on-state losses, i.e. power dissipation when the device is passing forward current. The higher the $V_{CE(sat)}$ the higher the losses in the forward direction.

Switching Speed – an IGBT with fast switching speed will have higher efficiency during the transition from on to the off state and vice versa. Low switching speed versions are often combined with low $V_{CE(sat)}$ for low frequency applications. Higher speed IGBT tend to have higher $V_{CE(sat)}$.

Temperature Coefficient – this determines the device $V_{CE(sat)}$ trend against temperature. A device is said to have a positive temperature coefficient if the $V_{CE(sat)}$ rises when the junction temperature increases. Likewise a negative temperature coefficient is when the devices $V_{CE(sat)}$ reduces when the junction temperature increases. A positive temperature coefficient is required when operating IGBT in parallel. A negative temperature coefficient device cannot be operated in parallel but may have lower losses at higher temperatures.

Safe Operating Area (SOA) – the ability for an IGBT to sustain voltage and current in shorter time scales without failure. Forward bias (FBSOA) is SOA when turning the IGBT into the on-state. Reverse Bias (RBSOA) is SOA when turning to the off-state. Short circuit SOA (SCSOA) is an indication of ability to withstand surge currents in operation.

Avalanche Rated – the ruggedness of the IGBT in the avalanche region. An avalanche rated devices is far more rugged than altertive devices during operation and is an indication of reliability.

IGBT technology

IGBT Characteristic	Non-Punch Through (NPT)	XPT Planar	XPT GenX3		XPT Trench		BiMOSFET (RC IGBT)			High voltage IGBT		
Discrete Part No. Prefix	IXD..	IXA..	IXY..		IXX..		IXB..			IXG..		
Discrete Part No. Suffix	NONE	NONE	B3	C3	B4	C4	NONE	A (1700V)	C	NONE	A	C
$V_{CE(sat)}$	MEDIUM	MEDIUM	MED.	HIGH	LOW	MED.	LOW	MED.	HIGH	LOW	MED.	HIGH
Switching Speed	MEDIUM	MEDIUM	MED.	HIGH	MED.	HIGH	LOW	MED.	MED.	LOW	MED.	MED.
Temperature Coefficient	POSITIVE	POSITIVE	POSITIVE		POSITIVE		POSITIVE			POSITIVE		
Safe Operating Area	SCSOA RBSOA FBSOA	SCSOA RBSOA FBSOA	SCSOA RBSOA FBSOA		SCSOA RBSOA		SCSOA RBSOA			SCSOA RBSOA FBSOA		
Avalanche Rated	YES	YES	YES		NO		NO			YES		
Voltage Range	600-1700V	600-1200V	650 / 650 / 900 / 1200V		650V		1600-3000V			1600-4500V		

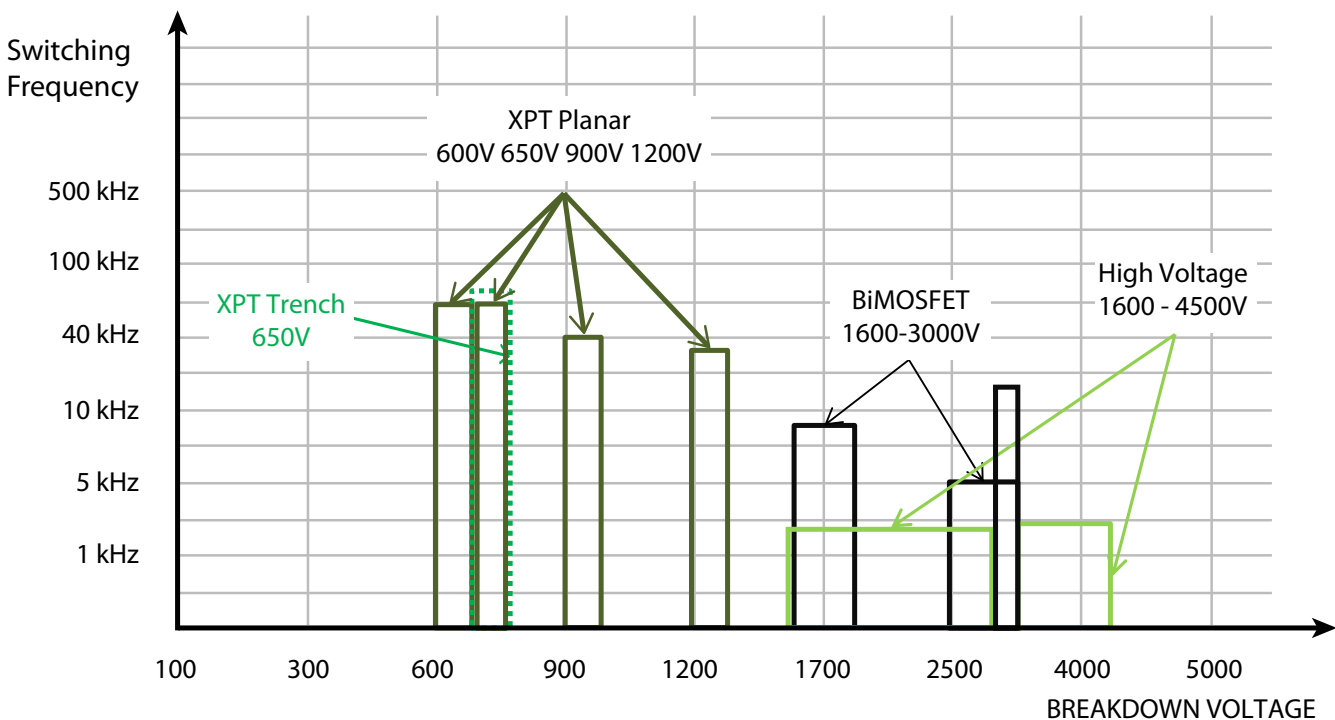

Insulated Gate Bipolar Transistors (IGBT)

IGBT product families

Xtreme Light Punch Through (XPT™) Planar IGBTs

are an extremely rugged technology platform of IGBTs, which are ideal for critical applications that require low conduction and low switching losses with a 10 μ s short circuit withstand capability. Either discrete or co-packaged with ultrafast soft recovery Sonic diodes. IXYS XPT IGBTs have lower saturation voltage $V_{CE(sat)}$ and low total switching energy ($E_{on} + E_{off}$). A large portfolio of module packed Planar XPTs are available for applications such as UPS, Motor Drive and solar inverters.

Xtreme Light Punch Through (X2PT™) Planar IGBTs

are the second generation of XPT IGBTs. Features are 10 μ s short circuit capability, 175°C max junction temperature, further reduced $V_{CE(sat)}$ and lower turn-off losses (E_{off}) resulting in a competitive performance to latest trench devices at reduced R_{th} . Thus they are ideally suited for Motor Drive inverters.

Xtreme Light Punch Through (XPT™) Trench IGBTs

are the latest development from IXYS starting at 650 V. This range features not only a low $V_{CE(sat)}$ but extremely low switching losses making the platform attractive for fast switching applications whilst retaining good SOA rating and a positive temperature coefficient. Either discrete or co-packaged with ultrafast soft recovery Sonic diodes. IXYS XPT IGBTs have industry leading efficiency at medium to high switching frequency.

1600 V & 1700 V Low Sat IGBTs

These rugged High Voltage NPT devices are designed for capacitor discharge applications. featuring a low saturation voltage, high power density & high peak current capability. These High Voltage NPT IGBTs enable the elimination of more costly, lower performance solutions such as thyristors or series connected MOSFETs or IGBTs typically used at voltages above 1200 V. Offered as co-packs, they provide a more complete solution for power conversion applications.

1600 V & 1700 V High Speed IGBTs

This family of 1600/1700 V IGBTs are rugged NPT devices targeted for high voltage applications, requiring 10 μ s short circuit withstand capability. They are particularly suitable for high voltage switching applications. IXYS offers its fast switching "A" version 1700 V NPT IGBTs in co-pack and phase-leg configurations for PWM applications with switching frequencies upwards of 50 kHz.

Very High Voltage (2500 V - 4000 V) IGBTs

IXYS offers a unique portfolio of discrete 2500 V, 3000 V and 4000 V VHV IGBTs with collector current ratings spanning from 2 A to 75 A ($T_c = 110^\circ\text{C}$). The voltage and current ratings of these devices, coupled with simplified MOS gate-control, allow the system designer to greatly reduce the complexity of many high voltage switching designs. These IGBTs enable the use of a single device in systems whose circuits previously used multiple, cascaded, lower-voltage switches.

B-series (BiMOSFET) IGBTs

IXYS BiMOSFETs are devices which have combined strengths of MOSFETs and IGBTs. BiMOSFETs feature a monolithic intrinsic diode which can reduce die count in many applications.

600V XPT™ Planar IGBTs

XPT = Xtreme light Punch Through. short-circuit rated IGBTs

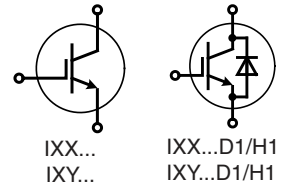





Part Number	V _{CE(s)}	I _{C25} T _C = 25°C	I _{C110} T _C = 110°C	V _{CE(sat)} T _C = 25°C	t _{fi} typ. T _J = 150°C	E _{off} typ. T _J = 150°C	R _{thJC}	Diode	I _{F110} Diode T _C = 110°C	R _{thJC} max. Diode	P _C	Fig. No.	Package style
▶ New	V	A	A	V	ns	mJ	K/W		A	K/W	W		Outline drawings on pages O-31...O-52
B3 Class (5-30 kHz switching)													
▶ IXXQ 30N60B3M	600	33	19	1.85	180	0.7	1.66				90	X017c	X005a TO-220AB
IXXH 30N60B3		60	30	1.85	180	0.7	0.55				270	X014a	
IXXH 30N60B3D1		60	30	1.85	180	0.7	0.55	• 30	0.90		270	X014a	
IXXA 50N60B3		120	50	1.8	190	1.2	0.25				600	X011b	
IXXH 50N60B3		120	50	1.8	190	1.2	0.25				600	X014a	
IXXH 50N60B3D1		120	50	1.8	190	1.2	0.25	• 30	0.90		600	X014a	X011b TO-263AB
IXXP 50N60B3		120	50	1.8	190	1.2	0.25				600	X005a	
IXXR 100N60B3H1		145	68	1.8	200	2.8	0.31	• -	0.62		400	X016a	
IXXH 75N60B3		160	75	1.85	170	2.2	0.20				750	X014a	
IXXH 75N60B3D1		160	75	1.85	170	2.2	0.20	• 30	0.90		750	X014a	X011c TO-263ABHV
IXXN 100N60B3H1		170	-	1.8	200	2.8	0.25	• 50	0.42		500	X027a	
IXXK 100N60B3H1		200	-	1.8	200	2.8	0.18	• 65	0.30		695	X020a	
IXXN 200N60B3H1		200	98	1.7	215	3.45	0.16	• 30	0.70		780	X027a	
IXXX 100N60B3H1		200	-	1.8	200	2.8	0.18	• 65	0.30		695	X015a	X014a TO-247AD
IXXH 100N60B3		220	100	1.8	200	2.8	0.18				830	X014a	
IXXN 200N60B3		280	160	1.7	215	3.45	0.16				940	X027a	
IXXK 200N60B3		380	200	1.7	215	3.45	0.092				1630	X020a	
IXXX 200N60B3		380	200	1.7	215	3.45	0.092				1630	X015a	X017c TO-3PPF
IXXK 300N60B3		550	300	1.6	200	3.7	0.065				2300	X020a	
IXXX 300N60B3		550	300	1.6	200	3.7	0.065				2300	X015a	
C3 Class (20-60 kHz switching)													
▶ IXXH 30N60C3	600	60	30	2.2	32	0.4	0.55				270	X014a	
IXXH 30N60C3D1		60	30	2.2	78	0.4	0.55	• 30	0.90		270	X014a	
IXXH 50N60C3		100	50	2.3	90	0.48	0.25				600	X014a	X015a PLUS247
IXXH 50N60C3D1		100	50	2.3	90	0.48	0.25	• 30	0.90		600	X014a	
IXXH 75N60C3		150	75	2.3	80	1.07	0.20				750	X014a	
IXXH 75N60C3D1		150	75	2.3	80	1.07	0.20	• 30	0.90		750	X014a	
IXXK 100N60C3H1		170	-	2.2	115	1.4	0.18	• 65	0.30		695	X020a	X017c TO-3PPF
IXXX 100N60C3H1		170	-	2.2	115	1.4	0.18	• 65	0.30		695	X015a	
IXXH 100N60C3		190	100	2.2	115	1.4	0.18				830	X014a	
IXXN 200N60C3H1		200	98	2.1	90	2.1	0.16	• 30	0.70		780	X027a	
IXXK 200N60C3		340	200	2.1	90	2.1	0.092				1630	X020a	X011c ISOPLUS247™
IXXX 200N60C3		340	200	2.1	90	2.1	0.092				1630	X015a	
IXXK 300N60C3		510	300	2	90	2.35	0.065				2300	X020a	
IXXX 300N60C3		510	300	2	90	2.35	0.065				2300	X015a	
IXXA 30N65C3HV	650	52	30	2.2	78	0.4	0.65				230	X011c	

Discrete XPT™

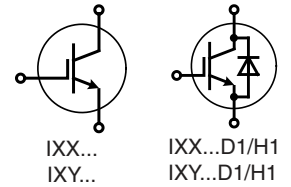
650V XPT™ Planar IGBTs

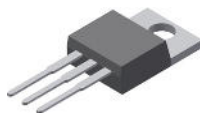
XPT = Xtreme light Punch Through. short-circuit rated IGBTs



Part Number	V _{CES}	I _{C25}	I _{C110}	V _{CE(sat)}	t _{fi} typ.	E _{off} typ.	R _{thJC}	Diode	I _{F110}	R _{thJC}	P _C	Fig. No.	Package style
		T _C = 25°C	T _C = 110°C	T _C = 25°C	T _J = 150°C	T _J = 150°C	K/W		Diode T _C = 110°C	max. Diode	W		
A3 Class (up to 5kHz switching)													
IXYN 100N65A3	650	170	110	1.8	160	2.40	0.25				600	X027a	X005a TO-220AB
B3 Class (10-30 kHz switching)													
IXYQ 30N65B3D1	650	70	30	2.1	93	1.00	0.55	•	50	0.60	270	X017a	
IXYH 30N65B3D1		70	30	2.1	93	1.00	0.55	•	50	0.60	270	X014a	
IXYH 40N65B3		86	40	2.0	174	1.15	0.50				300	X014a	
IXYQ 40N65B3D1		86	40	2.0	174	1.15	0.50	•	50	0.60	300	X017a	
IXYH 40N65B3D1		86	40	2.0	174	1.15	0.50	•	50	0.60	300	X014a	
IXYH 100N65B3		225	100	1.85	160	2.16	0.18				830	X014a	
IXYK 100N65B3D1	225	100	1.85	160	2.16	0.18	•	67	0.36	830	X020a	X007a TO-220ABFP	
IXYX 100N65B3D1	225	100	1.85	160	2.16	0.18	•	67	0.36	830	X015a		
C3 Class (20-60 kHz switching)													
IXYP 10N65C3D1M	650	15	7	2.6	38	0.15	2.83	•	13	4.0	53	X007a	
IXYP 20N65C3D1M		18	9	2.5	36	0.40	3.00	•	13	4.0	50	X007a	
IXYP 15N65C3D1M		18	9	2.5	42	0.24	2.63	•	13	4.0	57	X007a	
IXYP 10N65C3		30	10	2.5	38	0.15	0.94				160	X005a	
IXYP 10N65C3D1		30	10	2.5	38	0.15	0.94	•	23	1.85	160	X005a	
IXYP 15N65C3		38	15	2.5	42	0.24	0.75				200	X005a	
IXYP 15N65C3D1		38	23	2.5	42	0.24	0.75	•	23	1.85	200	X005a	
IXYA 20N65C3		50	20	2.5	36	0.40	0.65				230	X011b	
IXYH 20N65C3		50	20	2.5	36	0.40	0.65				230	X014a	
IXYP 20N65C3D1		50	20	2.5	36	0.40	0.65	•	23	1.85	200	X005a	
IXYH 30N65C3H1		60	30	2.7	30	0.41	0.55	•	29	0.80	270	X014a	
IXYH 30N65C3		60	30	2.7	30	0.41	0.55				270	X014a	
IXYT 30N65C3H1HV		60	30	2.7	30	0.41	0.55	•	29	0.80	270	X019a	
IXYP 30N65C3		60	30	2.7	30	0.41	0.55				270	X005a	
IXYQ 40N65C3D1		80	40	2.35	30	0.53	0.50	•	50	0.60	300	X017a	
IXYH 40N65C3		80	40	2.35	30	0.53	0.50				300	X014a	
IXYH 40N65C3H1		80	40	2.35	80	0.46	0.50	•	40	0.60	300	X014a	
IXYH 40N65C3D1		80	40	2.35	30	0.53	0.50	•	50	0.60	300	X014a	
IXYH 50N65C3H1		130	50	2.1	42	0.56	0.25	•	40	0.60	600	X014a	
IXYP 50N65C3		132	50	2.1	32	0.70	0.25				600	X005a	
IXYH 50N65C3D1	132	50	2.1	32	0.70	0.25	•	50	0.60	600	X014a		
IXYH 50N65C3	132	50	2.1	32	0.70	0.25				600	X014a		
IXYA 50N65C3	132	50	2.1	32	0.70	0.25				600	X011b		
IXYN 75N65C3D1	140	67	2.3	64	1.30	0.28	•	46	0.53	535	X027a	X015a PLUS247	
IXYN 100N65C3H1	160	90	2.3	66	1.15	0.25	•	50	0.42	600	X027a		
IXYH 75N65C3H1	175	75	2.3	58	1.30	0.20	•	62	0.45	750	X014a		
IXYH 75N65C3	175	75	2.3	64	1.30	0.20				750	X014a		
IXYH 75N65C3D1	175	75	2.3	64	1.30	0.20	•	62	0.45	750	X014a		
IXYX 100N65C3D1	200	100	2.3	66	1.15	0.18	•	67	0.36	830	X015a	X017a TO-3P	
IXYH 100N65C3	200	100	2.3	66	1.15	0.18				830	X014a		
IXYK 100N65C3D1	200	100	2.3	66	1.15	0.18	•	67	0.36	830	X020a		

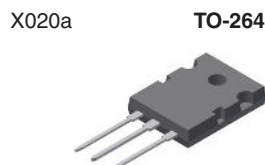
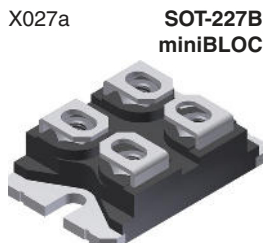

650V XPT™ Trench IGBTs

XPT = Xtreme light Punch Through. short-circuit rated IGBTs

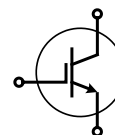

IXX...
IXZ...

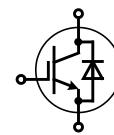

IXX...D1/H1
IXZ...D1/H1

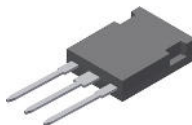
Part Number	V _{CES}	I _{C25} T _C = 25°C	I _{C110} T _C = 110°C	V _{CE(sat)} T _C = 25°C	t _{fi} typ. T _J = 150°C	E _{off} typ. T _J = 150°C	R _{thJC}	Diode	I _{F110} Diode T _C = 110°C	R _{thJC} max. Diode	P _C	Fig. No.	Package style Outline drawings on pages O-31...O-52	
														V
B4 Class (10-30 kHz switching)														
IXXH 30N65B4	650	65	30	2.0	100	0.6	0.65				230	X014a	X014a TO-247AD 	
IXXH 60N65B4H1		116	60	2.2	94	1.34	0.33	•	40	0.60	455	X014a		
IXXH 60N65B4		116	60	2.2	94	1.34	0.33				455	X014a		
IXXH 40N65B4		120	40	2.0	73	0.78	0.33				455	X014a		
IXXH 40N65B4H1	120	40	2.0	73	0.78	0.33	•	40	0.60	455	X014a			
IXXR 110N65B4H1	150	70	2.2	105	1.40	0.33	•	48	0.70	455	X016a			
IXXH 80N65B4	650	160	80	2.0	65	1.65	0.24				625	X014a		X015a PLUS247 
IXXH 80N65B4H1		160	80	2.0	65	1.65	0.24	•	62	0.45	625	X014a		
IXXN 110N65B4H1		215	110	2.1	105	1.40	0.20	•	70	0.42	750	X027a		
IXXK 110N65B4H1		240	110	2.1	105	1.40	0.17	•	78	0.38	880	X020a		
IXXX 110N65B4H1		240	110	2.1	105	1.40	0.17	•	78	0.38	880	X015a		
IXXK 160N65B4		310	160	1.8	160	2.36	0.16				940	X020a		
IXXX 160N65B4		310	160	1.8	160	2.36	0.16				940	X015a		
IXXK 200N65B4		480	200	1.7	110	2.54	0.092				1630	X020a		
IXXX 200N65B4		480	200	1.7	110	2.54	0.092				1630	X015a		
C4 Class (20-60 kHz switching)														
IXXH 60N65C4	650	118	60	2.4	47	0.93	0.33				455	X014a		
IXXN 110N65C4H1		210	110	2.35	43	0.77	0.20	•	70	0.42	750	X027a		
IXXH 110N65C4		234	110	2.35	43	0.77	0.17				880	X014a		
IXXK 160N65C4		290	160	2.1	57	1.30	0.16				940	X020a		
IXXX 160N65C4		290	160	2.1	57	1.30	0.16				940	X015a		

X027a **SOT-227B miniBLOC**



X020a **TO-264**



X016a **ISOPLUS247™**

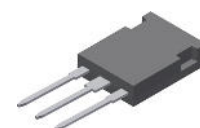

Discrete XPT™

900V XPT™ IGBT

XPT = Xtreme light Punch Through

Part Number	V _{CES}	I _{C25} T _C = 25°C	I _{C110} T _C = 110°C (90°C)	V _{CE(sat)} T _C = 25°C	t _{fi} typ. T _J = 125°C (150°C)	E _{off} typ. T _J = 125°C (150°C)	R _{thJC}	Diode	I _{F110} Diode T _C = 110°C	R _{thJC} max. Diode	P _C	Fig. No.	Package style	
➤ New	V	A	A	V	ns	mJ	K/W		A	K/W	W		Outline drawings on pages O-31...O-52	
900V GenX3™ XPT™ IGBTs														
➤ IXYA 8N90C3D1	900	20	8	2.5	163	0.22	1.2	•	12	2.50	125	X011b	X004 TO-252AA 	
➤ IXYP 8N90C3		20	8	2.5	163	0.22	1.2				125	X007a		
➤ IXYP 8N90C3D1		20	8	2.5	163	0.22	1.2	•	12		125	X007a		
➤ IXYY 8N90C3		20	8	2.5	163	0.22	1.2				125	X004		
➤ IXYH 24N90C3		44	24	2.7	130	0.55	0.62				240	X014a		
➤ IXYH 24N90C3D1		44	(24)	2.7	130	0.55	0.62	•	15		1.60	200		X014a
➤ IXYH 40N90C3D1		90	40	2.5	150	1.2	0.25	•	25		0.90	500		X014a
➤ IXYH 40N90C3		105	40	2.5	150	1.2	0.25				600	X014a		
➤ IXYN 80N90C3H1		115	(70)	2.7	(98)	(2.5)	0.25	•	42		0.42	500		X027a
➤ IXYH 60N90C3		140	60	2.7	(165)	(2.15)	0.2				750	X014a		
➤ IXYH 80N90C3		165	80	2.7	(98)	(2.5)	0.18				830	X014a		
➤ IXYT 80N90C3		165	80	2.7	(98)	(2.5)	0.18				830	X019		
➤ IXYK 140N90C3		310	140	2.7	(125)	(5)	0.092				1630	X020a		
➤ IXYX 140N90C3		310	140	2.7	(125)	(5)	0.092				1630	X015a		

X027a **SOT-227B miniBLOC**



X014a **TO-247AD**



X011b **TO-263AB**



1200V XPT™ IGBT

XPT = Xtreme light Punch Through

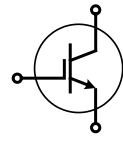

IXY ...

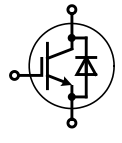

IXY...D1/H1

Part Number	V _{CE(sat)}	I _{C25} T _C = 25°C	I _{C110} T _C = 110°C	V _{CE(sat)} T _C = 25°C	t _{fi} typ. T _J = 125°C	E _{off} typ. T _J = 125°C	R _{thJC}	Diode	I _{F110} Diode T _C = 110°C	R _{thJC} max. Diode	P _C	Fig. No.	Package style	
														Outline drawings on pages O-31...O-52
➤ New	V	A	A	V	ns	mJ	K/W		A	K/W	W			
1200V GenX3™ XPT™ IGBTs														
B3 Class (5-30 kHz switching)														
IXYH 40N120B3D1	1200	86	40	2.9	206	2.05	0.26	•	25	0.90	480	X014a	X005a	TO-220AB
IXYH 40N120B3		96	40	2.9	206	2.05	0.26				577	X014a		
IXYN 100N120B3H1		165	76	2.6	° 260	10.1	° 0.18	•	42	0.42	690	X027a		
IXYK 100N120B3		225	100	2.6	° 260	10.1	° 0.13				1150	X020a		
IXYX 100N120B3		225	100	2.6	° 260	10.1	° 0.13				1150	X015a		
C3 Class (20-50 kHz switching)														
IXYJ 20N120C3D1	1200	21	9	3.4	° 105	0.7	° 1.19	•	15	1.25	105	X016c	X011c	TO-263ABHV
➤ IXYJ 30N120C3D1		32	14	3.3	° 140	1.6	° 0.89	•	15	1.25	140	X016c		
IXYH 20N120C3D1		36	17	3.4	° 105	0.7	° 0.54	•	23	0.90	230	X014a		
IXYT 20N120C3D1HV		36	17	3.4	° 105	0.7	° 0.54	•	23	0.90	230	X019a		
➤ IXYA 20N120C3HV		40	20	3.4	° 105	0.7	° 0.54				278	X011c		TO-247AD
IXYH 20N120C3		40	20	3.4	° 105	0.7	° 0.54				278	X014a		
IXYP 20N120C3		40	20	3.4	° 105	0.7	° 0.54				278	X005a	X014a	
IXYR 50N120C3D1		56	* 32	4.0	° 60	1.4	° 0.43	•	25	0.90	290	X016a		
IXYH 40N120C3D1		64	* 40	4.0	38	0.7	0.26	•	25	0.90	480	X014a		
IXYH 30N120C3		66	30	4.0	88	0.9	0.3				416	X014a		
IXYH 30N120C3D1		66	30	4.0	88	0.9	0.3	•	25	0.90	416	X014a		
IXYP 30N120C3		66	30	4.0	88	0.9	0.3				416	X005a		PLUS247
IXYH 40N120C3		70	40	4.0	38	0.7	0.26				577	X014a		
IXYH 50N120C3D1		90	**50	4.0	° 60	1.4	° 0.2	•	25	0.90	625	X014a	X015a	
IXYH 50N120C3		100	50	3.5	60	1.4	0.2				750	X014a		
IXYR 100N120C3		104	58	3.5	125	3.55	0.31				484	X016a		
IXYN 82N120C3		105	46	3.2	95	3.7	0.25				500	X027a		
IXYN 82N120C3H1		105	46	3.2	95	3.7	0.25	•	42	0.42	500	X027a		
IXYN 100N120C3H1		134	62	3.5	125	3.55	0.18	•	42	0.42	690	X027a		
IXYN1 00N120C3		152	86	3.5	125	3.55	0.18				830	X027a		
IXYB 82N120C3H1		160	82	3.2	95	3.7	0.12	•	42	0.35	1040	X021a	X016a	ISOPLUS247™
IXYH 82N120C3		160	82	3.2	95	3.7	0.12					X014a		
IXYK 100N120C3		188	100	3.5	125	3.55	0.13					X020a		
IXYX 100N120C3		188	100	3.5	125	3.55	0.13					X015a		
IXYK 120N120C3		220	120	3.5	° 120	5.3	° 0.1				1500	X020a		
IXYX 120N120C3		220	120	3.5	° 120	5.3	° 0.1				1500	X015a		
➤ IXYK 120N120C3		240	120	3.2	° 120	7.2	° 0.1				1500	X020a		
➤ IXYX 120N120C3		240	120	3.2	° 120	7.2	° 0.1				1500	X015a		
➤ IXYN 120N120C3		240	120	3.2	° 120	7.2	° 0.125				1200	X027a	X016c	

* T_C = 90°C
** T_C = 100°C

° T_J = 150°C

X027a **SOT-227B miniBLOC**



X021a **PLUS264**



X020a **TO-264**





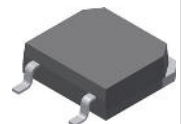



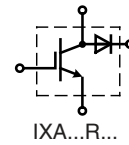

X019a **TO-268AAHV**



Discrete XPT™ / NPT IGBT

XPT IGBT XPT = Xtreme light Punch Through







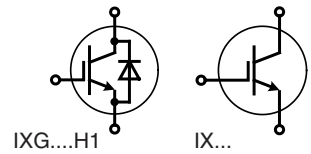

Type	V _{CES}	I _{C25} IGBT	I _{C90} IGBT	V _{CEsat typ} IGBT	E _{off} IGBT	R _{thJC} IGBT	Diode	I _{F90} Diode	Fig. No.	Package style
> New ○ Not for new design ◇ under development	V	T _C = 25°C A	T _C = 90°C A	T _J = 25°C V	T _J = 125°C mJ	K/W		T _C = 90°C A		Outline drawings on pages O-31...O-52
650 V XPT IGBT										
> IXA 220I650NA	650	335	220	*	*	*		-	X027a	X004 TO-252AA 
1200 V XPT IGBT										
> IXA 4I1200UC	1200	9	(100) 5	1.8	0.30	2.70		-	X004	X005a TO-220AB 
IXA 4IF1200UC		9	5	1.8	0.25	2.70	•	6	X004	
◇ IXA 4IF1200PZ		9	5	1.8	0.25	2.70	•	6	X011c	
IXA 4IF1200TC		9	5	1.8	0.25	2.70	•	6	X019	
IXA 12IF1200HB		20	13	1.8	1.10	1.50	•	14	X014a	
IXA 12IF1200PB		20	13	1.8	1.10	1.50	•	14	X005a	
IXA 12IF1200TC		20	13	1.8	1.10	1.50	•	14	X019	
IXA 17IF1200HJ		28	18	1.8	1.70	1.26	•	19	X016a	
IXA 20IF1200HB		38	22	1.8	1.70	0.76	•	24	X014a	
IXA 20I1200PB		38	22	1.8	1.70	0.76		-	X005a	
◇ IXA 20I1200PZ		38	22	1.8	1.70	0.76		-	X011c	X011c TO-263ABHV 
IXA 27IF1200HJ		43	27	1.8	3.00	0.84	•	25	X016a	
IXA 33IF1200HB		58	34	1.8	3.00	0.50	•	33	X014a	
IXA 37IF1200HJ		58	37	1.8	4.10	0.64	•	25	X016a	
IXA 45IF1200HB		78	45	1.8	4.10	0.38	•	33	X014a	
IXA 55I1200HJ		84	54	1.8	5.50	0.43		-	X016a	
IXA 60IF1200NA		88	56	1.8	5.50	0.43	•	51	X027a	X014a TO-247AD 
IXA 70I1200NA		100	65	1.8	5.50	0.35		-	X027a	
IXA 70R1200NA *		100	65	1.8	5.50	0.35	•	55	X027a	
1200 V Fast Trench IGBT										
> ITF 38IF1200HJ	1200	52	38 (80°C)	2.05	2 (175°C)	0.68	•	42	X016a	
* boost configuration										
NPT IGBT NPT = Non Punch Through										
600 V NPT IGBT										
○ IXDP 20N60B	600	32	20	2.2	0.4	0.90		-	X005a	X016a ISOPLUS247™ 
○ IXDP 20N60BD1		32	20	2.2	0.4	0.90	•	14	X005a	
○ IXDP 35N60B		60	35	2.1	0.8	0.50		-	X005a	
○ IXDH 35N60B		60	35	2.1	0.8	0.50		-	X014a	
○ IXDH 35N60BD1		60	35	2.1	0.8	0.50	•	21	X014a	
1200 V NPT IGBT										
○ IXDH 20N120		38	25	2.4	2.4	0.63		-	X014a	X019 TO-268AA 
○ IXDH 20N120D1		38	25	2.4	2.4	0.63	•	20	X014a	
○ IXDH 30N120		60	38	2.4	3.4	0.42		-	X014a	X027a SOT-227B miniBLOC 
○ IXDH 30N120D1		60	38	2.4	3.4	0.42	•	35	X014a	
○ IXDR 30N120D1		50	30	2.4	3.4	0.60	•	27	X016a	
IXDN 55N120D1		100	62	2.3	6.2	0.28	•	60	X027a	
IXDN 75N120		150	95	2.2	10.5	0.19		-	X027a	

G-Series PT IGBTs

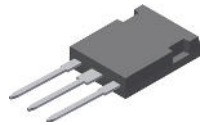
600 and 1200 V IGBTs



Part Number	V _{CES} V	I _{C25} T _C = 25°C A	I _{C110} T _C = 110°C A	V _{CE(sat)} max. T _J = 25°C V	t _{fi} typ. T _J = 25°C ns	E _{off} typ. T _J = 125°C mJ	R _{thJC} max. K/W	Diode	I _{F110} Diode T _C = 110°C A	R _{thJC} max. Diode K/W	PC W	Fig. No.	Package style
Outline drawings on pages O-31...O-52													
A3 Class (up to 5kHz switching)													
IXGH 36N60A3D4	600	75	36	1.40	325	5.3	0.56	• -	-	2.5	220	X014a	X005a TO-220AB  X011b TO-263AB  X014a TO-247AD  X015a PLUS247  X016a ISOPLUS247™  X019 TO-268AA  X020a TO-264  X027a SOT-227B miniBLOC 
IXGH 48N60A3D1		75	48	1.35	224	5.6	0.42	• -	-	0.9	300	X014a	
IXGH 72N60A3		75	72	1.35	250	6.5	0.23	- -	-	-	540	X014a	
IXGK 72N60A3H1		75	72	1.35	250	6.5	0.23	• -	-	0.3	540	X020a	
IXGR 72N60A3H1		75	72	1.35	250	6.5	0.62	• -	-	0.8	200	X016a	
IXGT 72N60A3		75	72	1.35	250	6.5	0.23	- -	-	-	540	X019	
IXGT 72N60B3		75	72	1.8	90	2.2	0.23	- -	-	-	540	X019	
IXGX 72N60A3H1		75	72	1.35	250	6.5	0.23	• -	-	0.3	540	X015a	
IXGH 56N60A3	150	56	56	1.35	315	6.75	0.375	- -	-	-	330	X014a	
IXGN 72N60A3	160	68	68	1.35	250	6.5	0.35	- -	-	-	360	X027a	
IXGK 120N60A3	200	120	120	1.35	260	10.4	0.16	- -	-	-	780	X020a	
IXGN 120N60A3	200	120	120	1.35	260	10.4	0.21	- -	-	-	595	X027a	
IXGN 120N60A3D1	200	120	120	1.35	260	10.4	0.21	• -	-	0.85	595	X027a	
IXGX 120N60A3	200	120	120	1.35	260	10.4	0.16	- -	-	-	780	X015a	
IXGK 320N60A3	320	210	210	1.25	740	na	0.125	- -	-	-	1000	X020a	
IXGN 320N60A3	320	170	170	1.25	740	na	0.17	- -	-	-	735	X027a	
IXGX 320N60A3	320	210	210	1.25	740	na	0.125	- -	-	-	1000	X015a	
IXGN 400N60A3	400	190	190	1.25	270	na	0.15	- -	-	-	830	X027a	
IXGA 36N60A3	na	36	36	1.40	325	5.3	0.56	- -	-	-	220	X011b	
IXGA 48N60A3	na	48	48	1.35	224	5.6	0.42	- -	-	-	300	X011b	
IXGH 36N60A3	na	36	36	1.40	325	5.3	0.56	- -	-	-	220	X014a	
IXGH 48N60A3	na	48	48	1.35	2.24	5.6	0.42	- -	-	-	300	X014a	
IXGH 64N60A3	na	64	64	1.35	222	6.0	0.27	- -	-	-	460	X014a	
IXGP 36N60A3	na	36	36	1.40	325	5.3	0.56	- -	-	-	220	X005a	
IXGP 48N60A3	na	48	48	1.35	224	5.6	0.42	- -	-	-	300	X005a	
IXGR 64N60A3	na	47	47	1.35	222	6.03	0.62	- -	-	-	200	X016a	
IXGR 72N60A3	na	52	52	1.35	250	6.5	0.62	- -	-	-	200	X016a	
IXGT 64N60A3	na	64	64	1.35	222	6.0	0.27	- -	-	-	460	X019	
IXGH 32N100A3	1000	75	32	2.20	540	13.0	0.42	- -	-	-	300	X014a	
IXGT 32N100A3		75	32	2.20	540	13.0	0.42	- -	-	-	300	X019	
IXGA 12N120A3	1200	22	na	3.00	1035	na	1.25	- -	-	-	100	X011b	
IXGH 12N120A3		22	na	3.00	1035	na	1.25	- -	-	-	100	X014a	
IXGP 12N120A3		22	na	3.00	1035	na	1.25	- -	-	-	100	X005a	
IXGA 20N120B3		36	na	3.10	155	1.63	0.69	- -	-	-	180	X011b	
IXGP 20N120B3		36	na	3.10	155	1.63	0.69	- -	-	-	180	X005a	
IXGA 20N120A3		40	20	2.50	715	10.1	0.69	- -	-	-	180	X011b	
IXGH 20N120A3		40	20	2.50	715	10.1	0.69	- -	-	-	180	X014a	
IXGP 20N120A3		40	20	2.50	715	10.1	0.69	- -	-	-	180	X005a	
IXGR 55N120A3H1		70	30	2.35	282	29.0	0.62	• -	-	0.42	200	X016a	
IXGH 32N120A3		75	na	2.35	1240	na	0.42	- -	-	-	300	X014a	
IXGT 32N120A3		75	32	2.35	1240	na	0.42	- -	-	-	300	X019	
IXGK 55N120A3H1		125	55	2.30	282	29.0	0.27	• -	-	0.42	460	X020a	
IXGX 55N120A3H1		125	55	2.30	282	29.0	0.27	• -	-	0.42	460	X015a	
IXGK 120N120A3		240	120	2.20	325	58.0	0.15	- -	-	-	830	X020a	
IXGX 120N120A3		240	120	2.20	325	58.0	0.15	- -	-	-	830	X015a	
IXGK 82N120A3		260	82	2.05	780	22.5	0.10	- -	-	-	1250	X020a	
IXGX 82N120A3		260	82	2.05	780	22.5	0.10	- -	-	-	1250	X015a	



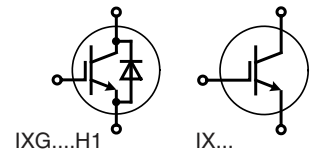

High Voltage NPT IGBTs

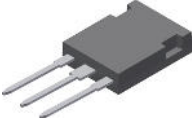
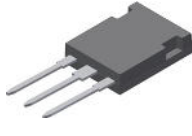
1700 V Low On-State Voltage NPT IGBTs



Part Type	V _{CES} V	I _C T _C = 25°C A	I _C T _C = 90°C (110°C) A	V _{CE(sat)} T _C = 25°C V	E _{off} typ T _J = 125°C mJ	R _{thJC} K/W	Diode	Fig. No.	Package style Outline drawings on pages O-31...O-52
IXGH 6N170	1700	12	6	4.0	2	1.65		X014a	X014a TO-247AD 
IXGT 6N170		12	6	4.0	2	1.65		X019	
IXGH 10N170		20	10	4.0		1.10		X014a	
IXGT 10N170		20	10	4.0		1.10		X019	
IXGH 16N170		32	16	3.5	11.2	0.65		X014a	
IXGT 16N170		32	16	3.5	11.2	0.65		X019	
IXGR 32N170H1		38	20	3.5	13.6	0.65	•	X016a	X015a PLUS247  X016a ISOPLUS247™ 
IXGF 32N170	44	(19)	3.5	13.5	0.62		X024c		
IXGH 24N170		50	24	3.3	12	0.50		X014a	
IXGT 24N170		50	24	3.3	12	0.50		X019	
IXGH 32N170		75	32	3.3	14	0.35		X014a	
IXGT 32N170		75	32	3.3	14	0.35		X019	
IXGX 32N170H1		75	32	3.3	22	0.35	•	X015a	
IXGN 100N170		160	95	3.0		0.17		X027a	
IXGX 100N170		170	100	3.0		0.15		X015a	
IXGK 100N170		170	100	3.0		0.15		X020a	

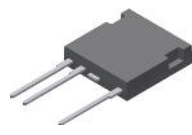

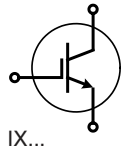

1700 V NPT IGBTs

Part Type	V _{CES} V	I _C T _C = 25°C A	I _C T _C = 90°C (110°C) A	V _{CE(sat)} T _C = 25°C V	t _{fi} typ T _J = 25°C ns	E _{off} typ T _J = 125°C mJ	R _{thJC} K/W	Diode	I _{F90} Diode T _C = 90°C A	R _{thJC} Diode K/W	Fig. No.	Package style
➤ New												
IXGR 6N170A	1700	5.5	(2.5)	7	32	0.25	2.5				X016a	X019 TO-268AA 
IXGH 6N170A		6	3	7	32	0.26	1.65				X014a	X020a TO-264 
IXGT 6N170A		6	3	7	32	0.26	1.65				X019	
IXGH 10N170A		10	5	6	35	0.6	0.89				X014a	X024c ISOPLUS i4-PAC™ 
IXGT 10N170A		10	5	6	35	0.6	0.89				X019	
IXGH 16N170A		16	11	5	70	2.0	0.65				X014a	X027a SOT-227B miniBLOC 
IXGH 16N170AH1		16	11	5	70	2.0	0.65	•	17	0.90	X014a	
IXGR 16N170AH1		16	8	5	40	1.1	1.04	•	15	1.50	X016a	
IXGT 16N170A		16	11	5	70	2.0	0.65				X019	
IXGT 16N170AH1		16	11	5	70	2.0	0.65	•	17	0.90	X019	
IXGH 24N170A		24	16	6	40	1.47	0.5				X014a	
IXGH 24N170AH1		24	16	6	40	1.47	0.5	•	16	0.90	X014a	
IXGT 24N170A		24	16	6	40	1.47	0.5				X019	
IXGT 24N170AH1		24	16	6	40	1.47	0.5	•	16	0.90	X019	
IXGR 32N170AH1		26	14	5.2	50	2.4	0.65	•	14	1.50	X016a	
IXGH 32N170A		32	21	5	50	2.4	0.35				X014a	
IXGT 32N170A		32	21	5	50	2.4	0.35				X019	
IXGX 32N170AH1		32	21	5	50	1.7	0.35	•	18	0.35	X015a	

Very High Voltage NPT IGBTs



2.5 kV - 4 kV NPT IGBT



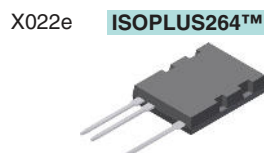
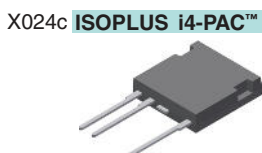
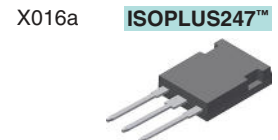
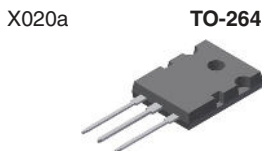

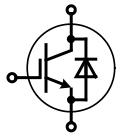

Part Type	V_{CES}	I_{C25} $T_C = 25^\circ C$	I_{C110} $T_C = 110^\circ C$ ($90^\circ C$)	$V_{CE(sat)}$ $T_C = 25^\circ C$	t_{ri} typ $T_J = 25^\circ C$	E_{off} typ $T_J = 125^\circ C$	R_{thJC} IGBT	P_c	Fig. No.	Package style
➤ New	V	A	A	V	ns	mJ	K/W	W		Outline drawings on pages O-31...O-52
IXGF 20N250	2500	23	(14)	3.1	930	na	1.25	100	X024c	X011c TO-263ABHV 
IXGA 20N250HV		30	12	3.1	930	na	0.83	150	X011c	
IXGF 25N250		30	15	2.9	200	na	1.10	114	X024c	
IXLF 19N250A		32	19	3.9	250	30	0.50	250	X024c	
IXGH 25N250		60	25	2.9	200	na	0.50	250	X014a	
IXGT 25N250		60	25	2.9	200	na	0.50	250	X019	
IXGT 25N250HV		60	25	2.9	200	na	0.50	250	X019a	
IXGL 75N250		110	(65)	2.9	455	na	0.29	430	X022e	X014a TO-247AD 
IXGK 75N250		170	75	2.7	455	na	0.16	780	X020a	
IXGX 75N250		170	75	2.7	455	na	0.16	780	X015a	
IXGH 10N300	3000	18	(10)	3.5	530	na	1.25	100	X014a	X014c TO-247HV 
IXGF 20N300		22	(14)	3.2	210	na	1.25	100	X024c	
IXGF 25N300		27	(16)	3.0	500	na	1.10	114	X024c	
IXGF 36N300		36	18	2.7	540	na	0.78	160	X024c	
IXEL 40N400	4000	90	40	3.5	425	205	0.26	380	X022e	X015a PLUS247 
➤ IXA 40I4000KN		80	40	2.7	200	125	0.28	450	X022e	
➤ IXYF 30N450	4500	23	17	3.9	1220	na	0.54	230	X024c	X015a PLUS247 
➤ IXYT 30N450HV		60	30	3.9	1220	na	0.29	430	X019a	
➤ IXYF 40N450		60	32	3.9	1120	na	0.43	290	X024c	
➤ IXYH 30N450HV		60	30	3.9	1220	na	0.29	430	X014c	
➤ IXYL 60N450		90	38	3.3	1360	na	0.3	417	X022e	
➤ IXYX 40N450HV		95	40	3.9	1120	na	0.19	660	X015c	



BiMOSFETs (Monolithic Bipolar MOS Transistors)



1.6 kV - 2.5 kV

Type	V _{CES}	I _{C25} T _C = 25°C	I _{C90} T _C = 90°C (110°C)	V _{CE(sat)} typ (max) T _C = 25°C (110°C)	Q _G typ	t _f (t _{fi}) typ T _C = 125°C	R _{thJC} max.	Fig. No.	Package style
➤ New	V	A	A	V	nC	ns	K/W		Outline drawings on pages O-31...O-52
IXBH 5N160G	1600	5.7	3.5	4.9	26	(70)	1.85	X014a	X005a TO-220AB 
IXBP 5N160G		5.7	3.5	4.9	26	(70)	1.85	X005a	
IXBF 9N160G		7	4	4.9	34	(70)	1.75	X024c	
IXBH 9N160G		9	5	4.9	34	(70)	1.25	X014a	
IXBF 40N160		28	16	6.2	130	(40)	0.50	X024c	
IXBH 40N160		33	20	6.2	130	(40)	0.35	X014a	
IXBH 6N170	1700	12	6	2.84	17	600	1.65	X014a	X011c TO-263ABHV 
IXBT 6N170		12	6	2.84	17	600	1.65	X019	
➤ IXBA 16N170AHV		16	10	(6)	65	(150)	0.83	X011c	X014a TO-247AD 
IXBH 16N170A		16	10	(6)	65	(150)	0.83	X014a	
IXBT 16N170A		16	10	(6)	65	(150)	0.83	X019	
➤ IXBT 16N170AHV		16	10	(6)	65	(150)	0.83	X019a	
IXBH 10N170		20	10	3.4	30	(150)	0.89	X014a	
IXBT 10N170		20	10	3.4	30	(150)	0.89	X019	
IXBN 42N170A		38	21	5.2	188	(82)	0.40	X027a	
IXBH 16N170		40	16	(3.3)	72	705	0.50	X014a	
IXBT 16N170		40	16	(3.3)	72	705	0.50	X019	
IXBH 42N170A		42	21	5.2	188	(82)	0.35	X014a	
IXBT 42N170A		42	21	5.2	188	(82)	0.35	X019	
IXBR 42N170		57	32	(2.9)	188	740	0.62	X016a	X015a PLUS247 
IXBH 24N170		60	24	(2.5)	140	960	0.50	X014a	
IXBT 24N170		60	24	(2.5)	140	960	0.50	X019	X016a ISOPLUS247™ 
IXBN 75N170A		75	42	4.95	358	(175)	0.20	X027a	
IXBH 42N170		80	42	(2.8)	188	740	0.35	X014a	X019 TO-268AA 
IXBT 42N170		80	42	(2.8)	188	740	0.35	X019	
IXBK 75N170A		110	65	4.95	358	(175)	0.12	X020a	
IXBX 75N170A		110	65	4.95	358	(175)	0.12	X015	
IXBN 75N170		145	75	2.6	350	580	0.20	X027a	
IXBK 75N170		200	(75)	2.6	350	580	0.12	X020a	
IXBX 75N170		200	(75)	2.6	350	580	0.12	X015a	
IXCH 36N250	2500	73	(36)	2.6	177	900	0.21	X014a	
IXCK 36N250		73	(36)	2.6	177	900	0.21	X020a	
IXBL 64N250		116	(46)	2.5	400	175	0.25	X022e	
IXBK 64N250		156	(64)	2.5	400	175	0.17	X020a	
IXBX 64N250		156	(64)	2.5	400	175	0.17	X015a	

X027a **SOT-227B miniBLOC**



X024c **ISOPLUS i4-PAC™**

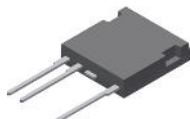

X022e **ISOPLUS264™**







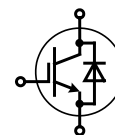

X020a **TO-264**



BiMOSFETs (Monolithic Bipolar MOS Transistors)



3 kV - 3.6 kV

Type	V_{CES}	I_{C25} $T_C = 25^\circ\text{C}$	I_{C90} $T_C = 90^\circ\text{C}$ (110°C)	$V_{CE(sat)}$ typ (max) $T_C = 25^\circ\text{C}$ (110°C)	Q_G typ	t_r typ $T_C = 125^\circ\text{C}$	R_{thJC} max.	Fig. No.	Package style
➤ New	V	A	A	V	nC	ns	K/W		Outline drawings on pages O-31...O-52
➤ IXBF 14N300		28	14	2.2	62	1730	1.04	X024c	X011c TO-263ABHV 
➤ IXBF 10N300C		29	(10)	4.6	208	165 (t_{fi})	0.52	X024c	
➤ IXBH 10N300		30	(10)	2.8	45	1030	0.69	X014a	
➤ IXBA 10N300HV		34	(10)	2.2	46	2010	0.69	X011c	
➤ IXBH 10N300HV		34	(10)	2.2	46	2010	0.69	X014c	
➤ IXBF 15N300C		37	(15)	4.7	267	150 (t_{fi})	0.42	X024c	X014a TO-247AD 
➤ IXBF 22N300		38	22	2.2	110	1650	0.83	X024c	
➤ IXBA 14N300HV		38	(14)	2.2	62	1730	0.62	X011c	
➤ IXBH 14N300HV		38	(14)	2.2	62	1730	0.62	X014c	
IXBF 32N300		40	22	2.8	142	630	0.78	X024c	
➤ IXBF 28N300		50	28	2.3	110	3280	0.58	X024c	X014c TO-247HV 
➤ IXBL 20N300C		50	(20)	4.5	425	175 (t_{fi})	0.30	X022e	
IXBF 42N300		60	(20)	2.5	200	490	0.52	X024c	
➤ IXBT 22N300HV		60	(22)	2.2	110	1650	0.43	X019a	
➤ IXBH 22N300HV		60	(22)	2.2	110	1650	0.43	X014c	
➤ IXBX 28N300HV		62	(28)	2.3	110	3280	0.36	X015c	X015a PLUS247 
IXBH 32N300		80	(32)	2.8	142	630	0.31	X014a	
IXBT 32N300		80	(32)	2.8	142	630	0.31	X019	
IXBF 55N300		86	(34)	2.7	335	260	0.35	X024c	
➤ IXBH 42N300HV		104	(42)	2.5	200	490	0.25	X014c	
IXBT 42N300HV		104	(42)	2.5	200	490	0.25	X019a	X015a PLUS247 
IXBK 55N300		130	(55)	2.7	335	260	0.20	X020a	
IXBX 55N300		130	(55)	3.2	335	260	0.20	X015a	
➤ IXBF 20N360	3600	45	(18)	2.9	110	1100	0.54	X024c	
➤ IXBH 20N360HV		70	(20)	2.9	110	1100	0.29	X014c	
➤ IXBT 20N360HV		70	(20)	2.9	110	1100	0.29	X019a	X015a PLUS247 
➤ IXBF 50N360		70	(28)	2.4	210	1670	0.43	X024c	
➤ IXBL 60N360		92	(36)	2.8	450	1025	0.30	X022e	
➤ IXBX 50N360HV		125	(50)	2.4	210	1670	0.19	X015c	

X019a **TO-268AAHV**



X019 **TO-268AA**



X015c **PLUS247HV**



X024c **ISOPLUS i4-PAC™**

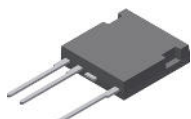

X022e **ISOPLUS264™**

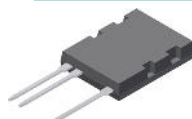

X020a **TO-264**



IGBT Modules – CBI Configuration

Type		Rectifier 3~			Inverter 3~					Brake chopper		
		V_{RRM}	I_{DAVM} $T_C = 80^\circ\text{C}$	R_{thJC} typ.	V_{CES}	I_C $T_C = 25^\circ\text{C}$	I_C $T_C = 80^\circ\text{C}$	$V_{CE(sat)}$ typ.	R_{thJC} typ.	V_{CES}	I_C $T_C = 80^\circ\text{C}$	R_{thJC} typ.
<input type="radio"/> Not for new design	<input checked="" type="radio"/> New	V	A	K/W	V	A	A	V	K/W	V	A	K/W
600 V NPT IGBT												
	MUBW 10-06A6K	1600	61	2.10	600	12	8	2.5	2.80	600	8	2.80
	MUBW 15-06A6K		65	1.90		19	14	2.4	1.70		8	2.80
	MUBW 20-06A6K		65	1.90		25	17	2.0	1.50		8	2.80
<input type="radio"/>	MUBW 25-06A6K		65	1.90		31	21	2.1	1.25		14	1.70
	MUBW 35-06A6K		89	1.40		42	29	2.3	0.95		17	1.50
1200 V NPT IGBT												
	MUBW 15-12A6K	1600	89	1.40	1200	19	13	3.0	1.35	1200	13	1.35
	MUBW 30-12A6K		89	1.40		30	21	3.0	0.95		13	1.35
1200 V Trench IGBT												
	MUBW 45-12T6K	1600	104	1.10	1200	43	31	2.5	0.80	1200	13	1.35
1200 V XPT IGBT												
	MIXA 10WB1200TML	1600	69	1.80	1200	17	12	1.8	2.00	1200	12	2.00
	MIXA 20WB1200TML		105	1.10		28	20	1.8	1.26		12	2.00

Type		Rectifier 3~			Inverter 3~					Brake chopper		
		V_{RRM}	I_{DAVM} $T_C = 80^\circ\text{C}$	R_{thJC} typ.	V_{CES}	I_C $T_C = 25^\circ\text{C}$	I_C $T_C = 80^\circ\text{C}$	$V_{CE(sat)}$ typ.	R_{thJC} typ.	V_{CES}	I_C $T_C = 80^\circ\text{C}$	R_{thJC} typ.
<input type="radio"/> Not for new design	<input checked="" type="radio"/> New	V	A	K/W	V	A	A	V	K/W	V	A	K/W
600 V NPT IGBT												
<input type="radio"/>	MUBW 10-06A7	1600	18	1.5	600	20	15	1.9	1.5	600	15	1.5
<input type="radio"/>	MUBW 15-06A7		18	1.5		25	18	1.9	1.3		15	1.5
	MUBW 20-06A7		24	1.3		35	25	1.9	1.0		18	1.4
	MUBW 30-06A7		24	1.3		50	35	1.9	0.7		18	1.3
	MUBW 50-06A7		29	1.1		75	50	1.9	0.5		25	1.0
600 V XPT IGBT												
<input checked="" type="radio"/>	MIXA 50WB600TED	1200	119	1.2	600	64	43	1.6	0.8	600	20	1.26
1200 V NPT IGBT												
<input type="radio"/>	MUBW 10-12A7	1600	18	1.5	1200	20	15	2.3	1.2	1200	15	1.2
	MUBW 15-12A7		24	1.3		35	25	2.0	0.7		15	1.2
	MUBW 25-12A7		24	1.3		50	35	2.2	0.55		15	1.2
	MUBW 35-12A7		29	1.1		50	35	2.5	0.55		25	0.7
1200 V Trench IGBT												
<input type="radio"/>	MUBW 15-12T7	1600	24	1.3	1200	25	15	1.7	1.2	1200	15	1.2
1200 V XPT IGBT												
	MIXA 10WB1200TED	1600	105	1.1	1200	17	12	1.8	2.0	1200	12	2.0
	MIXA 20WB1200TED		105	1.1		28	20	1.8	1.26		12	2.0
	MIXA 30WB1200TED		105	1.1		43	30	1.8	0.84		12	2.0
	MIXA 40WB1200TED		105	1.1		50	40	1.8	0.64		20	1.26

IGBT Modules – CBI Configuration

CBI 3

IGBT Modules

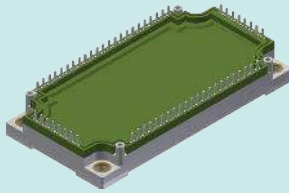

X113 E3-Pack

Outline drawings on pages O-31...O-52
See data sheet for pin arrangement

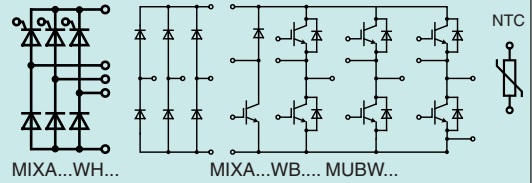

Type	Rectifier 3~			Inverter 3~					Brake chopper			Layout
	V_{RRM}	I_{DAVM} $T_H = 80^\circ\text{C}$	R_{thJC} typ.	V_{CES}	I_C $T_C = 25^\circ\text{C}$	I_C $T_C = 80^\circ\text{C}$	$V_{CE(sat)}$ typ.	R_{thJC} typ.	V_{CES}	I_C $T_C = 80^\circ\text{C}$	R_{thJC} typ.	
○ Not for new design ◇ under development	V	A	K/W	V	A	A	V	K/W	V	A	K/W	
600 V NPT IGBT												
○ MUBW 50-06A8	1600	40	1.10	600	75	50	1.9	0.50	600	25	1.00	A
MUBW 75-06A8		46	0.94		100	65	2.0	0.39		35	0.75	A
○ MUBW 100-06A8		60	0.73		125	85	1.9	0.30		50	0.55	A
1200 V NPT IGBT												
○ MUBW 35-12A8	1600	27	1.30	1200	50	35	2.5	0.55	1200	25	0.70	A
MUBW 50-12A8		46	0.94		85	60	2.2	0.35		35	0.55	A
1200 V Trench IGBT												
MUBW 50-12T8	1600	50	0.94	1200	75	50	1.7	0.45	1200	35	0.55	A
MUBW 75-12T8		50	0.94		105	75	1.7	0.35		35	0.55	A
1200 V XPT IGBT												
MIXA 60WB1200TEH	1600	190	0.65	1200	85	60	1.8	0.43	1200	40	0.64	A
MIXA 60WH1200TEH ¹		135	0.65		85	60	1.8	0.43		40	0.64	C
MIXA 80WB1200TEH		265	0.50		120	84	1.8	0.32		40	0.64	A
MIXA 81WB1200TEH		290	0.45		120	84	1.8	0.32		60	0.43	B
1200 V X2PT IGBT												
◇ MIXG 85WB1200TEH	1600	290	0.45	1200	140	85	1.7		1200	60	0.43	B
1700 V Trench IGBT												
MUBW 50-17T8	2200	120	1.10	1700	74	53	2.0	0.43	1700	34	0.62	A
MUBW 75-17T8		140	0.95		113	80	2.0	0.48		34	0.62	A

¹ input rectifier half-controlled

Layout A

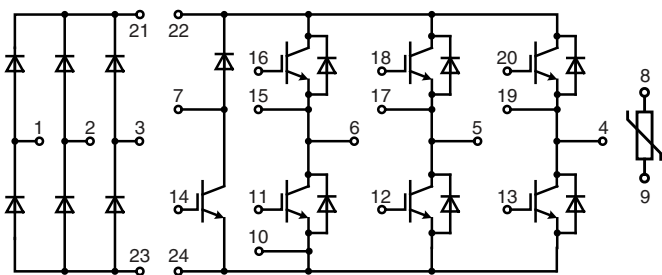

Layout C

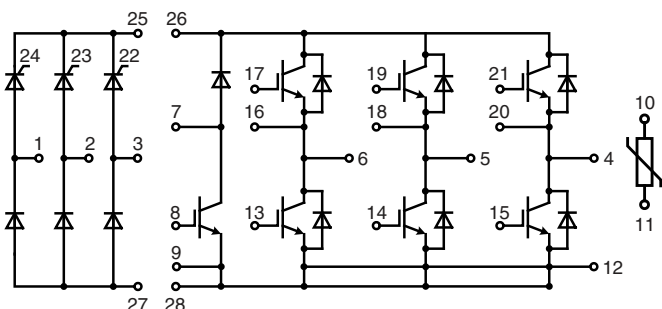

Layout B

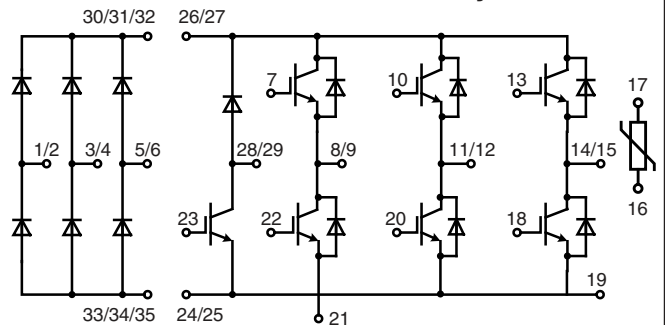

IGBT Modules – Six-Pack configuration

Six-Pack IGBT Modules		X111 E1-Pack		Outline drawings on pages O-31...O-52		See data sheet for pin arrangement			
Type	V_{CES}	I_{C25} IGBT $T_C = 25^\circ\text{C}$	I_{C80} IGBT $T_C = 80^\circ\text{C}$	$V_{CE(sat)}$ typ IGBT $T_J = 25^\circ\text{C}$	E_{off} IGBT $T_J = 125^\circ\text{C}$	R_{thJC} IGBT	I_{F25} Diode $T_C = 25^\circ\text{C}$	I_{F80} Diode $T_C = 80^\circ\text{C}$	NTC
○ Not for new design ➤ New	V	A	A	V	mJ	K/W	A	A	NTC
1200 V Trench IGBT									
MWI 60-12T6K		58	41	1.9	4.8	0.62	49	32	•
MWI 80-12T6K		80	56	2.0	6.5	0.46	80	51	•
1200 V XPT IGBT									
○ MIXA 10W1200TML	1200	17	12	1.8	1.1	2.00	19	13	•
○ MIXA 20W1200TML		28	20	1.8	1.7	1.26	33	22	•
○ MIXA 30W1200TML		43	30	1.8	3.0	0.84	44	29	•
○ MIXA 40W1200TML		60	40	1.8	4.1	0.64	44	29	•

Six-Pack IGBT Modules		X112 E2-Pack		Outline drawings on pages O-30...O-55		See data sheet for pin arrangement				
Type	V_{CES}	I_{C25} IGBT $T_C = 25^\circ\text{C}$	I_{C80} IGBT $T_C = 80^\circ\text{C}$	$V_{CE(sat)}$ typ IGBT $T_J = 25^\circ\text{C}$	E_{off} IGBT $T_J = 125^\circ\text{C}$	R_{thJC} IGBT	I_{F25} Diode $T_C = 25^\circ\text{C}$	I_{F80} Diode $T_C = 80^\circ\text{C}$	NTC	Layout
◇ under development ○ Not for new design ➤ New	V	A	A	V	mJ	K/W	A	A	NTC	Layout
600 V NPT IGBT										
○ MWI 30-06A7	600	45	30	1.9	1.0	0.88	36	24		A
MWI 30-06A7T		45	30	1.9	1.0	0.88	36	24	•	A
○ MWI 50-06A7		75	50	1.9	1.7	0.55	72	45		A
○ MWI 50-06A7T		75	50	1.9	1.7	0.55	72	45	•	A
○ MWI 75-06A7		90	60	2.1	2.5	0.44	140	85		A
MWI 75-06A7T		90	60	2.1	2.5	0.44	140	85	•	A
650 V XPT IGBT										
➤ MIXA 50W650TED	650	*	50	1.5	1.2 (150°C)	*	*	*	•	B
➤ MIXA 75W650TED		*	75	1.5	1.7 (150°C)	*	*	*	•	B
1200 V NPT IGBT										
○ MWI 15-12A7	1200	30	20	1.0	1.8	0.88	25	17		A
○ MWI 25-12A7		50	35	2.2	2.8	0.55	50	33		A
○ MWI 25-12A7T		50	35	2.2	2.8	0.55	50	33	•	A
○ MWI 50-12A7		85	60	2.2	5.6	0.35	110	70		A
○ MWI 50-12A7T		85	60	2.2	5.6	0.35	110	70	•	A
1200 V Trench IGBT										
MWI 35-12T7T	1200	60	35	1.7	4.1	0.62	50	33	•	B
MWI 50-12T7T		75	50	1.7	6.5	0.49	110	70	•	B
MWI 75-12T7T		105	75	1.7	9.5	0.35	150	100	•	B
1200 V XPT IGBT										
MIXA 30W1200TED	1200	43	30	1.8	3.0	0.84	44	29	•	B
MIXA 40W1200TED		60	40	1.8	4.1	0.64	44	29	•	B
MIXA 60W1200TED		85	60	1.8	5.5	0.43	88	59	•	B
MIXA 80W1200TED		120	84	1.8	8.3	0.32	135	90	•	B
1200 V X2PT IGBT										
◇ MIXG 85W1200TED	1200	140	85	1.7	7.7		135	90	•	B

* in progress

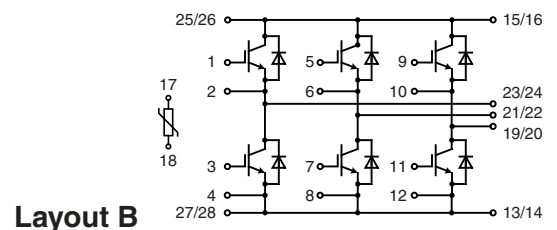
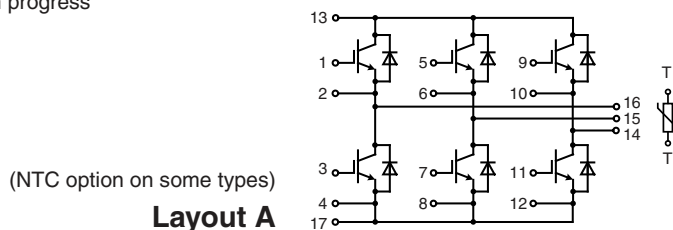

IGBT Modules – Six-Pack configuration

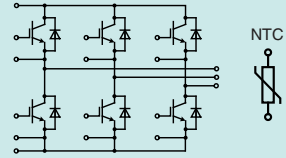
Six-Pack IGBT Modules		X113 E3-Pack Outline drawings on pages O-31...O-52 See data sheet for pin arrangement								
Type	V_{CES}	I_{C25} IGBT $T_C = 25^\circ\text{C}$	I_{C80} IGBT $T_C = 80^\circ\text{C}$	$V_{CE(sat)}$ typ IGBT $T_J = 25^\circ\text{C}$	E_{off} IGBT $T_J = 125^\circ\text{C}$	R_{thJC} IGBT	I_{F25} Diode $T_C = 25^\circ\text{C}$	I_{F80} Diode $T_C = 80^\circ\text{C}$	NTC	Layout
<ul style="list-style-type: none"> ◇ under development ○ Not for new design ➤ New 	V	A	A	V	mJ	K/W	A	A		
600 V NPT IGBT										
MWI 100-06A8	600	130	88	2.0	2.9	0.30	140	88		A
MWI 150-06A8		170	115	2.0	4.6	0.24	210	130		A
○ MWI 200-06A8		215	155	2.0	6.3	0.18	260	165		A
650 V XPT TRENCH IGBT										
◇ MIXD 200W650TEH	650	*	200	1.6	7.5 (150°C)	*	*	*	•	B
1200 V NPT IGBT										
○ MWI 75-12A8	1200	125	85	2.2	10.5	0.25	150	100		A
○ MWI 100-12A8		160	110	2.2	14.6	0.19	200	130		A
1200 V SPT+ IGBT										
MIEB 100W1200DPFTEH		183	128	1.8	9.7	0.20	135	90	•	B
MIEB 101W1200EH		183	128	1.8	9.7	0.20	135	90		A
MIEB 101W1200DPFEH		183	128	1.8	9.7	0.20	135	90		A
1200 V Trench IGBT										
○ MWI 75-12T8T	1200	100	75	1.7	9.5	0.35	150	100	•	B
○ MWI 150-12T8T		200	150	1.7	17.0	0.18	196	132	•	B
1200 V XPT IGBT										
MIXA 80W1200TEH	1200	120	84	1.8	8.3	0.32	135	90	•	B
MIXA 100W1200TEH		155	108	1.8	11.0	0.25	135	90	•	B
MIXA 150W1200TEH		220	150	1.8	16.0	0.18	190	130	•	B
1200 V X2PT										
◇ MIXG 120W1200TEH	1200	170	120	1.7	8.5		135	90	•	B
◇ MIXG 180W1200TEH		230	170	1.7	12.0		230	145	•	B

* in progress

Layout A

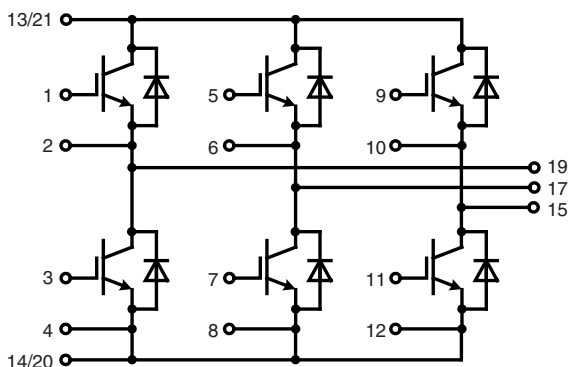

Layout B

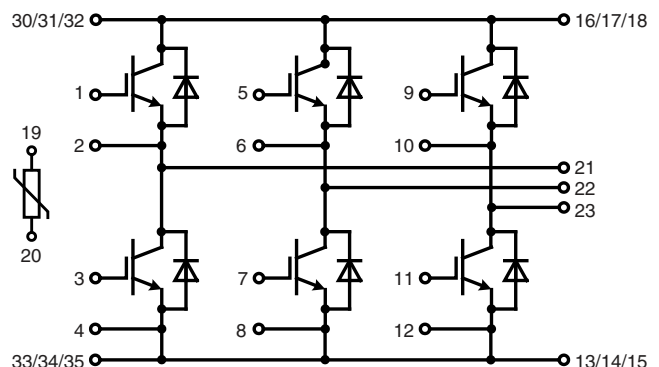

IGBT Modules in MiniPack2B package

MiniPack2B with PressFIT Pins

X109 MiniPack2B

Outline drawings on
pages O-31...O-52

See data sheet for pin arrangement

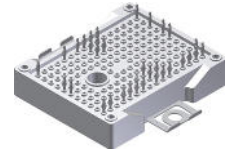

Multi Level Configuration

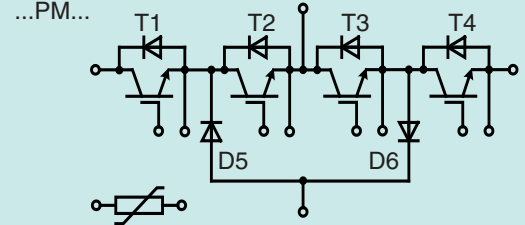

Type	V_{RRM}	IGBTs T1 & T4				IGBTs T2 & T3				Diodes D5 & D6			
		I_C $T_C = 25^\circ\text{C}$	I_C $T_C = 80^\circ\text{C}$	$V_{CE(sat)}$ typ.	R_{thJC} typ.	I_C $T_C = 25^\circ\text{C}$	I_C $T_C = 80^\circ\text{C}$	$V_{CE(sat)}$ typ.	R_{thJC} typ.	I_D $T_C = 25^\circ\text{C}$	I_D $T_C = 80^\circ\text{C}$	V_F typ.	R_{thJC} typ.
◇ under development		A	A	V	K/W	A	A	V	K/W	A	A	V	K/W
MIXA 50PM650TMI	650	75	50	1.6	0.80	75	50	1.6	0.80	55	40	1.8	1.2
MIXA 100PM650TMI		150	100	1.6	0.35	150	100	1.6	0.35	130	100	1.8	0.6
◇ MIXD 80PM650TMI		108	82	1.5	0.55	147	110	1.5	0.40	114	83	1.7	0.6

CBI Configuration

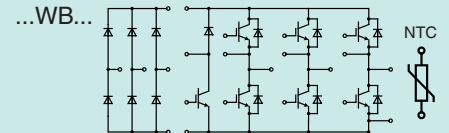

Type	Rectifier 3~			Inverter 3~					Brake chopper		
	V_{RRM}	I_{DAVM} $T_C = 80^\circ\text{C}$	R_{thJC} typ.	V_{CES}	I_C $T_C = 25^\circ\text{C}$	I_C $T_C = 80^\circ\text{C}$	$V_{CE(sat)}$ typ.	R_{thJC} typ.	V_{CES}	I_C $T_C = 80^\circ\text{C}$	R_{thJC} typ.
	V	A	K/W	V	A	A	V	K/W	V	A	K/W
MIXA 20WB1200TMI	1600	105	1.5	1200	28	20	1.8	1.26	1200	12	2.00
MIXA 30WB1200TMI		105	1.1	1200	43	30	1.8	0.84	1200	20	1.26

Six-Pack Configuration

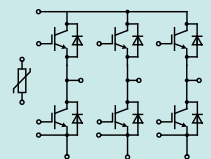

Type	V_{CES}	I_{C25} IGBT $T_C = 25^\circ\text{C}$	I_{C80} IGBT $T_C = 80^\circ\text{C}$	$V_{CE(sat)}$ typ IGBT $T_J = 25^\circ\text{C}$	E_{off} IGBT $T_J = 125^\circ\text{C}$	R_{thJC} IGBT	I_{F25} Diode $T_C = 25^\circ\text{C}$	I_{F80} Diode $T_C = 80^\circ\text{C}$	NTC
◇ under development	V	A	A	V	mJ	K/W	A	A	
◇ MIXA 40W1200TMI	1200	60	40	1.8	4.1	0.64	44	29	•
◇ MIXA 60W1200TMI		85	60	1.8	5.5	0.43	88	59	•

IGBT XPT™ Modules in SimBus F package

- space savings
- reduced protection circuits
- package designed for wave soldering

Package style

Outline drawings
on pages
O-31...O-52

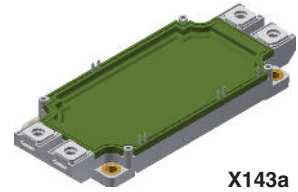

X143a

Type	V _{CES}	I _{C80} IGBT T _C = 80°C A	V _{CE(sat) typ} IGBT T _J = 25°C V	E _{on} IGBT T _J = 125°C mJ	E _{off} IGBT T _J = 125°C mJ	R _{thJC} IGBT K/W	I _{F80} Diode T _C = 80°C A	R _{thJC} Diode K/W	Fig. No.
➤ New ◇ under development	V								
Phase-Leg									
MIXA 600PF650TSF	650	490	1.65	6	23	0.085	340	0.095	X143a
MIXA 225PF1200TSF	1200	250	1.80	20	27	0.115	185	0.145	
MIXA 300PF1200TSF		325	1.80	20	42	0.085	185	0.145	
➤ MIXG 330PF1200TSF		330	1.70	*	30	*	265	0.095	
MIXA 450PF1200TSF		450	1.80	22	68	0.060	265	0.095	
➤ MIXG 490PF1200TSF		490	1.70	*	45	*	265	0.095	
◇ MIXG 300PF1700TSF	1700	425	300	*	*	*	*	•	
◇ MIXG 450PF1700TSF		635	450	*	*	*	*	•	
Brake / Boost									
MIXA 225RF1200TSF	1200	250	1.80	20	27	0.115	185	0.145	
Common Emitter									
◇ MIXA 600AF650TSF	650	490	1.65	6	23	0.085	340	0.095	
Common Collector									
◇ MIXA 600CF650TSF	650	490	1.65	6	23	0.085	340	0.095	
Multi Level (one half)									
◇ MIXA 430LD1200TSF ¹	1200 650	430 345	1.80 1.65	34 6.5	44 15	0.064 0.100	265 200	0.110 0.145	

* in progress ¹ two MIXA 430DL1200TSF build a T-type (NPC2 type) multi level circuit

...PF...
phase-leg

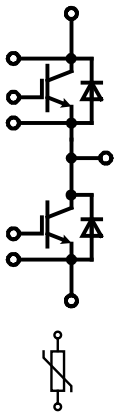

...RF...
brake / boost

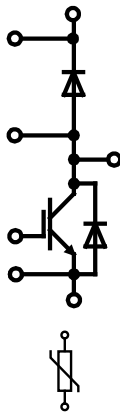

...AF...
common emitter

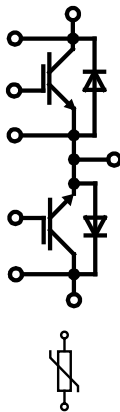

...CF...
common collector

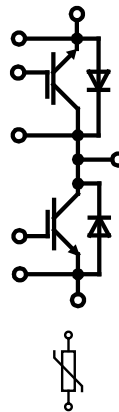

...LD...
multi level (one half)

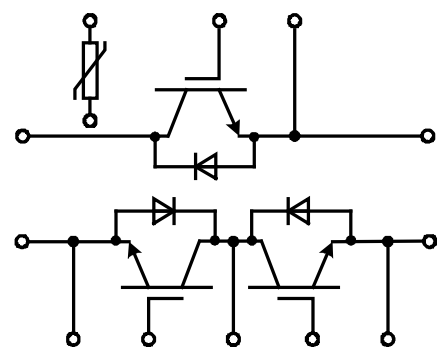

IGBT Full Bridge and SOLAR Inverter Modules

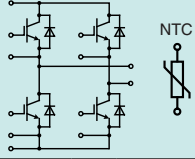
<h2>Full Bridge</h2> <p>IGBT Modules</p> 									
Type	Technology	V_{CES}	I_{C25} IGBT $T_C = 25^\circ\text{C}$	I_{C80} IGBT $T_C = 80^\circ\text{C}$	$V_{CE(sat)}$ typ IGBT $T_J = 25^\circ\text{C}$	E_{off} IGBT $T_J = 125^\circ\text{C}$	I_{F80} Diode $T_C = 80^\circ\text{C}$	NTC	Fig. No.
○ Not for new design ➤ New		V	A	A	V	mJ	A		
○ MKI 80-06T6K	Trench	600	89	67	1.8	2.8	67	•	X111
○ MKI 50-06A7	NPT	600	72	50	1.9	1.7	45	•	X112
○ MKI 50-06A7T			72	50	1.9	1.7	45	•	
○ MKI 65-06A7T			100	67	2.0	2.3	85	•	
○ MKI 75-06A7 MKI 75-06A7T			90	60	2.5	6.3	85	•	
○ MKI 50-12F7 MKI 100-12F8	Fast NPT	1200	65	45	3.2	2.5	70		X113
			65	45	3.2	2.5	70		X113
MIXA 61H1200ED MIXA 81H1200EH	XPT	1200	85	60	1.8	5.5	59		X112
			120	84	1.8	8.3	90		X113
○ MIEB 101H1200EH			183	128	1.8	9.7	90		
➤ MITA 150H1700TEH	Trench	1700	210	145	2.0	47	120	•	

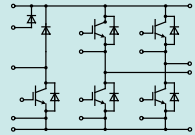
<h2>SOLAR Inverter Modules</h2> <p>Fast XPT IGBT Full Bridge & Boost Stage & Bypass Diode</p> 									
Type	Technology	V_{CES}	I_{C25} IGBT $T_C = 25^\circ\text{C}$	I_{C80} IGBT $T_C = 80^\circ\text{C}$	$V_{CE(sat)}$ typ IGBT $T_J = 25^\circ\text{C}$	E_{on} IGBT $T_J = 150^\circ\text{C}$	E_{off} IGBT $T_J = 150^\circ\text{C}$	I_{F80} Diode $T_C = 80^\circ\text{C}$	Fig. No.
➤ New		V	A	A	V	mJ	mJ	A	
MIXB 52HR600ED	fast XPT & SONIC	600	78	52	1.8	1.38	0.8	29	X112
MIXB 52HR600DCGED	fast XPT & SiC		78	52	1.8	0.67	0.8	20	

Outline drawings on pages O-31...O-52

X111 E1-Pack

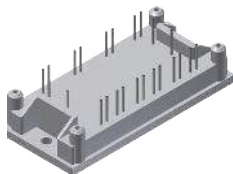

X112 E2-Pack

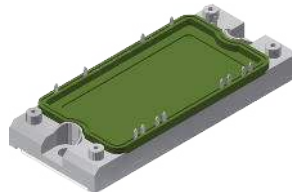

X113 E3-Pack

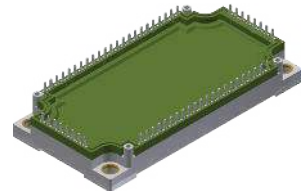

NPT / XPT / X2PT

IGBT Modules

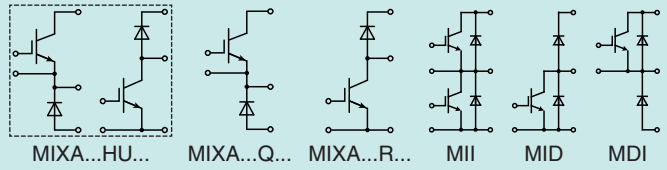

Type	V_{CES} V	I_{C25} IGBT $T_C = 25^\circ\text{C}$ A	I_{C80} IGBT $T_C = 80^\circ\text{C}$ A	$V_{CE(sat)}$ typ IGBT $T_J = 25^\circ\text{C}$ V	E_{off} IGBT $T_J = 125^\circ\text{C}$ mJ	R_{thJC} IGBT K/W	I_{F25} Diode $T_C = 25^\circ\text{C}$ A	I_{F80} Diode $T_C = 80^\circ\text{C}$ A	Fig. No.
Half Bridge. XPT. X2PT									
◇ MIXA 100PF650YI	650	144	107	1.6	(150°C) 3.7	0.40	91	67	X127a
◇ MIXG 200PF1200YI	1200	280	210	1.7	(150°C) 17	0.16	230	165	X128a
◇ MIXA 300PF1200TLP		440	310	1.75	32	0.09	340	250	
◇ MIXG 450PF1200TLP		820	620	1.7	(150°C) 50	0.055	680	500	
◇ MIXG 300PF1700TLP	1700	420	330	1.95	85	0.06	340	260	
1200 V Half Bridge. NPT									
MII 75-12A3	1200	90	60	2.2	5.6	0.33	100	60	X127a
MII 100-12A3		135	90	2.2	10.5	0.22	150	100	X128a
MII 145-12A3		160	110	2.2	15.0	0.18	150	100	
MII 150-12A4		180	120	2.2	11.5	0.17	200	130	
MII 200-12A4		270	180	2.2	21.0	0.11	300	200	
MII 300-12A4		330	220	2.2	29.0	0.09	450	270	
1200 V Boost Chopper. NPT									
MID 75-12A3	1200	90	60	2.2	5.6	0.33	100	60	X127b
MID 100-12A3		135	90	2.2	10.5	0.22	150	100	X128b
MID 145-12A3		160	110	2.2	15.0	0.18	150	100	
○ MID 150-12A4		180	120	2.2	11.5	0.17	200	130	
MID 200-12A4		270	180	2.2	21.0	0.11	300	200	
MID 300-12A4		330	220	2.2	29.0	0.09	450	270	
MID 550-12A4		670	460	2.3	59.0	0.05	750	460	
1200 V XPT IGBT Brake / Boost Chopper									
MIXA 80R1200VA	1200	120	84	1.9	8.3	0.32	135	90	X103
MIXA 150R1200VA		220	150	1.8	16	0.18	190	130	
1200 V Buck Chopper. NPT									
MDI 75-12A3	1200	90	60	2.2	5.6	0.33	100	60	X127c
MDI 100-12A3		135	90	2.2	10.5	0.22	150	100	X128c
MDI 145-12A3		160	110	2.2	15.0	0.18	150	100	
○ MDI 150-12A4		180	120	2.2	11.5	0.17	200	130	
MDI 200-12A4		270	180	2.2	21.0	0.11	300	200	
MDI 300-12A4		330	220	2.2	29.0	0.09	450	270	
MDI 550-12A4		670	460	2.3	59.0	0.05	750	460	
1200 V XPT IGBT Buck Chopper									
MIXA 150Q1200VA	1200	220	150	1.8	16	0.18	190	130	X103
1200 V XPT IGBT Buck / Boost switched reluctance Chopper									
MIXA 60HU1200VA	1200	85	60	1.8	5.5	0.43	88	59	X103

Outline drawings on pages O-31...O-52

X103

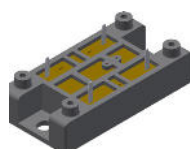

V1-Pack

X128a/b/c 62mm width

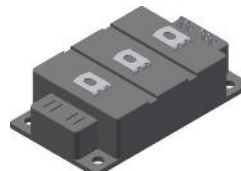

X127a/b/c 34mm width

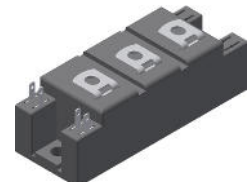

Power MOSFETs and MOSFET Modules

The Metal Oxide Semiconductor Field Effect Transistor (MOSFET) is a transistor that is used for high frequency switching control of power electronic systems. IXYS offer various MOSFET technology based on the customer requirement for voltage, switching frequency. A table giving a diagrammatic representation of our basic MOSFET offerings is given below.

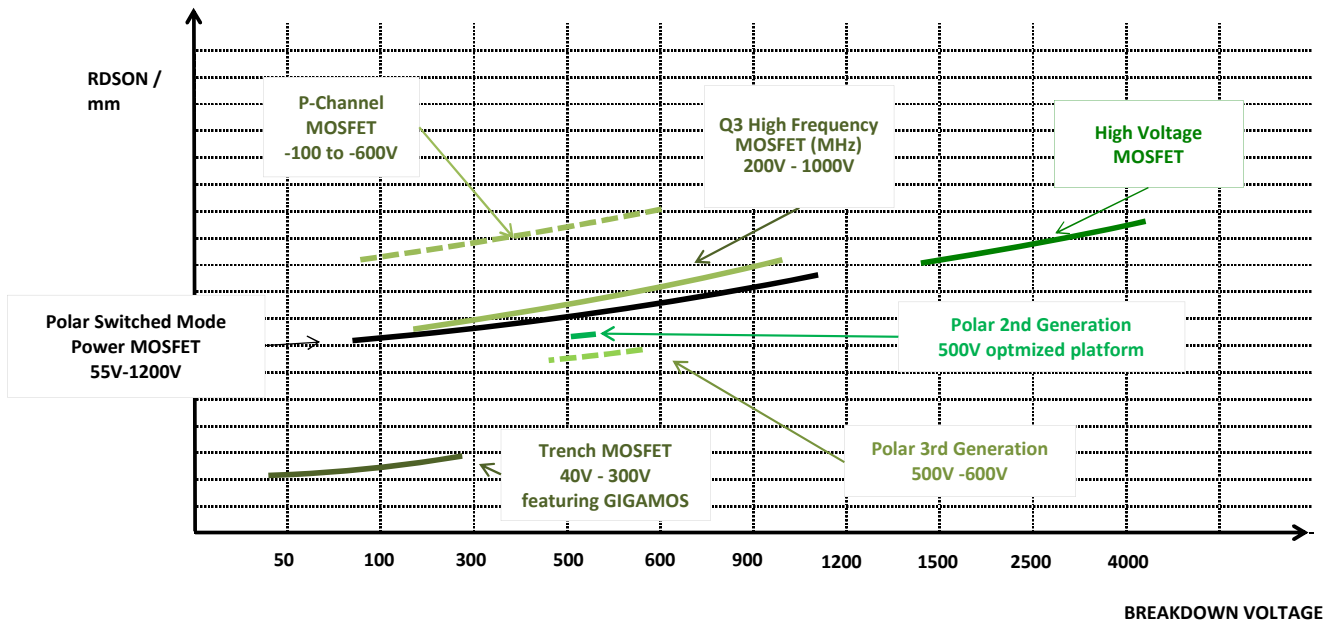

Trench and Trench2 Power MOSFETs

IXYS Trench Power MOSFETs are ideally suited for low-voltage, high-current applications. These MOSFETs feature an exceptionally low $R_{DS(on)}$, thus guaranteeing low power dissipation. Trench HiPerFET™ versions feature all of the advantages presented by IXYS' Trench Standard Power MOSFETs with an added benefit of a fast intrinsic rectifier which provides low reverse recovery charge (Q_{rr}) and excellent commutating dV/dt ratings for enhanced power switching capabilities and device ruggedness.

Polar™ Power MOSFETs

Polar™ MOSFETs (IXT..) feature a proprietary cell design and process that has resulted in a MOSFET with a 30% reduction in $R_{DS(on)}$ per unit area along with a decrease in gate charge. IXYS has also reduced the wafer thickness, which substantially reduces the thermal resistance. The combination of lower $R_{DS(on)}$, lower gate charge Q_g and higher power dissipation capability has resulted in a new class of MOSFETs, which will increase the cost effectiveness in switch mode power supply (SMPS) applications. IXYS' Polar™ HiPerFETs (IXF..) combine the strengths of the Polar Standard product family with a faster body diode, whose reverse recovery time (t_{rr}) is reduced to make them suitable for phase-shift bridges, motor control and uninterruptible power supply applications (UPS). This family of HiPerFETs provide lowest $R_{DS(on)}$, low R_{thJC} , low Q_g , and enhanced DV/DT capability.

PolarP2™ Power MOSFETs

PolarP2™ devices are an optimized range of the standard Polar platform for 500V device rating.

PolarP3™ HiPerFET Power MOSFETs

The PolarP3™ HiPerFET product family is the latest addition to IXYS' benchmark high-performance Polar-Series product line for our product portfolio between 500V and 600V. Its high Figure of Merit (FOM) being the multiplication of Q_g and in $R_{DS(on)}$ provide an excellent alternative to weaker super junction technologies. All IXYS Polar MOSFETs are tested 100% for avalanche energy providing the industries standard for reliability and ruggedness.

X-Class Power MOSFETs

These devices are developed using a charge compensation principle and proprietary process technology, resulting in Power MOSFETs with significantly reduced resistance $R_{DS(on)}$ and gate charge Q_g . They also exhibit a superior dv/dt performance. Designed for such applications as switched-mode and resonant-mode power supplies, DC-DC converters, PFC circuits, AC and DC motor drives, and robotic and servo control, these MOSFETs enable higher efficiency, along with high power density and cooler system performance. The X2-Class Power MOSFETs, devices with fast body diodes and avalanche ratings, are also available.

Q3-Class HiPerFET™ MOSFETs

Q3-Class HiPerFET™ MOSFETs (Identified by the suffix letter Q3) is the direct result of a revolutionary new chip design, which decreases the MOSFETs total gate charge (Q_g) and the Miller capacitance (C_{rss}), while maintaining the ruggedness and fast switching intrinsic diode of the company's current HiPerFET™ product line. The result is a MOSFET with dramatically improved switching efficiencies and thus enabling higher frequency operation and smaller power supplies.

Power MOSFETs and MOSFET Modules

Extended FBSOA Linear Power MOSFETs

IXYS' Extended FBSOA Linear Power MOSFETs are a class of rugged Power MOSFETs tailored specifically for applications that require Power MOSFETs to operate in their current saturation region. These new devices feature low static drain to source on-resistances and provide unparalleled performance and reliability in controlled current output applications. Typical applications that stand to benefit from this new class of extended FBSOA power MOSFETs include circuit breakers, current sources, programmable loads, power controllers, power regulators, motor control, power amplifiers and soft start applications. In the linear mode, a power MOSFET is subjected to high thermo-electrical stress caused by the simultaneous occurrence of high drain voltage and current resulting in high power dissipation. IXYS has optimized the internal structure of these MOSFETs achieving an extended "forward bias safe operating area" (FBSOA) capability to overcome the limitations posed by conventional power MOSFETs operating in current saturation region. These extended FBSOA Power MOSFETs are not intended for high speed switching applications.

Depletion-Mode MOSFET

Depletion-Mode Power MOSFETs operate in a 'normally-on' mode, not requiring energy or gate voltage for turn on. Unlike the regular enhancement type MOSFETs these Depletion-Mode MOSFETs require a negative gate bias to turn off. Consequently they remain on at or above zero gate bias voltage but otherwise have similar MOSFET characteristics. The "normally-on" operational mode of these devices combined with an enhanced linear operating capability allows for an ideal device selection in current sources, current regulators, solid-state relays, level shifting, active loads, start-up circuits and active power filters. Since these devices require no energy or gate voltage for turn-on, high energy efficiency can be achieved through device implementation in zero power "normally on" load switch applications. With the high degree of current regulation, these devices can also act as active inductors with high dynamic impedance in power filter applications to limit voltage and current noise and spikes. Furthermore these devices can provide active circuit protection to limit the surge of current during short-circuit or overload conditions.

PolarP™ P-Channel Power MOSFETs

IXYS' Polar technology platform employed in our PolarP™ P-Channel MOSFETs utilizes a proprietary cell design that improves overall device efficiency and performance. This technology platform reduces on-state resistance by as much as 30% and gate charge by 40% compared to legacy counterparts. With such low onstate resistances, these devices offer low conduction and switching losses while a low input capacitance. The combination of low $R_{DS(on)}$ and gate charge allow for improved energy efficiency. These P-Channel MOSFETs are dynamic dV/dt and avalanche rated making them extremely rugged in demanding operating environments and can easily be paralleled due to an on-state resistance with a positive temperature coefficient. They are ideal for 'high side' switching where a simple drive circuit referenced to ground can be used, circumventing additional 'high side' driver circuitry commonly involved when using an N-Channel MOSFET. This will help designers to reduce component count and improve reliability. Furthermore it allows for the design of a complementary power output stage. with a corresponding IXYS N-Channel MOSFET. for a power half bridge stage with a simple drive circuit.

TrenchP™ P-Channel Power MOSFETs









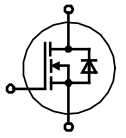

This family of P-Channel devices benefit from technological advances derived from IXYS' robust Trench cell design commonly implemented in their wide portfolio of industry recognized power devices. They feature an ultra low $R_{DS(on)}$, minimizing conduction losses and promoting improved operating and thermal efficiencies. These TrenchP™ P-Channel MOSFETs are suitable for 'high side' switching where a simple drive circuit referenced to ground can be employed, circumventing additional 'high side' driver circuitry commonly involved when using an N-Channel MOSFET. This enables designers to reduce component count, thereby improving drive circuit simplicity and cost structure. Furthermore it allows for the design of a complementary power output stage, with a corresponding IXYS N-Channel MOSFET, for a power half bridge stage with a simple drive circuit. Common applications that will greatly benefit from these devices include high side switching, high current regulators, DC Choppers, CMOS high power amplifiers, push-pull amplifiers and power solid state relays.

Very High Voltage Power MOSFETs

IXYS' VHV N-Channel Power MOSFETs are specifically designed to address demanding, fast-switching applications requiring blocking capabilities of 2.5kV to 4.5kV. These VHV Power MOSFETs are also ideally suited for parallel operation due to the positive temperature coefficient of their on-state resistance. Parallel operation with these devices provides a more cost-effective solution than employing series-connected, lower-voltage MOSFETs. The reduction or replacement of multiple series-connected devices and the associated gate drive circuitry commonly involved, simplifies design, improves reliability and reduces over-all system cost. These VHV MOSFETs represent an optimal solution in applications such as laser and x-ray generation systems, high-voltage power supplies, pulse circuits, high voltage automated test equipment and capacitor discharge circuits. 4.5kV device offerings feature high isolation capability with superior thermal performance.

Trench Power MOSFETs



Part Type	V _{DSS}	I _{D(cont)} ^{Chip} T _C = 25°C A	R _{DS(on)} T _J = 25°C Ω	C _{iss} typ. ns	Q _g typ. ns	t _{rr} typ. ns	R _{thJC} K/W	P _D W	Fig. No.	Package style
➤ New	V	A	Ω	ns	ns	ns	K/W	W		Outline drawings on pages O-31...O-52
IXTP 44N10T	100	44	0.03	1567	27.4	60	1.15	130	X005a	X004 TO-252AA 
IXTY 44N10T		44	0.03	1567	27.4	60	1.15	130	X004	
IXTP 60N10T		60	0.018	2650	49	59	0.85	176	X005a	
IXTA 60N10T		60	0.018	2650	49	59	0.85	176	X011b	
IXTQ 60N10T		60	0.018	2650	49	59	0.85	176	X017a	
IXTP 80N10T		80	0.014	3040	60	100	0.65	230	X005a	
IXTA 80N10T		80	0.014	3040	60	100	0.65	230	X011b	
IXTF 200N10T		90	0.007	9400	152	76	0.96	156	X024d	X005a TO-220AB 
IXTL 2x180N10T		100	0.0074	6900	151	60	1.00	150	X022c	
IXTP 130N10T		130	0.0091	5080	104	67	0.42	360	X005a	X011b TO-263AB 
IXTH 130N10T		130	0.0091	5080	104	67	0.42	360	X014a	
IXTA 130N10T		130	0.0091	5080	104	67	0.42	360	X011b	
IXTQ 130N10T		130	0.0091	5080	104	67	0.42	360	X017a	
IXTP 180N10T		180	0.0064	6900	151	72	0.31	480	X005a	X014a TO-247AD 
IXTH 180N10T		180	0.0064	6900	151	100	0.31	480	X014a	
IXTA 180N10T		180	0.0064	6900	151	72	0.31	480	X011b	
IXTQ 180N10T		180	0.0064	6900	151	100	0.31	480	X017a	X014a TO-247AD 
IXTN 200N10T		200	0.0055	9400	152	76	0.30	550	X027a	
IXTH 200N10T		200	0.0055	9400	152	76	0.27	550	X014a	
IXTQ 200N10T		200	0.0055	9400	152	76	0.27	550	X017a	
IXTP 48N20T	200	48	0.05	3090	60	130	0.5	250	X005a	X017a TO-3P 
IXTA 48N20T		48	0.05	3090	60	130	0.5	250	X011b	
IXTQ 48N20T		48	0.05	3090	60	130	0.5	250	X017a	
IXTP 60N20T		60	0.04	4530	73	118	0.3	500	X005a	X011b ISOPLUS264™ 
IXTA 60N20T		60	0.04	4530	73	118	0.3	500	X011b	
IXTQ 60N20T		60	0.04	4530	73	118	0.3	500	X017a	
IXTP 86N20T		86	0.029	4500	90	140	0.31	480	X005a	
IXTA 86N20T		86	0.029	4500	90	140	0.31	480	X011b	X022c ISOPLUS264™ 
IXTQ 86N20T		86	0.029	4500	90	140	0.31	480	X017a	
IXTH 102N20T		102	0.023	6800	114	130	0.2	750	X014a	X014a ISOPLUS i4-PAC™ 
IXTQ 102N20T		102	0.023	6800	114	130	0.2	750	X017a	
IXTH 130N20T		130	0.016	8800	150	150	0.18	830	X014a	X027a SOT-227B miniBLOC 
IXTP 50N25T	250	50	0.06	4000	78	166	0.31	400	X005a	
IXTH 50N25T		50	0.06	4000	78	166	0.31	400	X014a	
IXTA 50N25T		50	0.06	4000	78	166	0.31	400	X011b	
IXTQ 50N25T		50	0.06	4000	78	166	0.31	400	X017a	
IXTP 76N25T		76	0.039	4920	92	148	0.27	460	X005a	
IXTH 76N25T		76	0.039	4920	92	148	0.27	460	X014a	
IXTA 76N25T		76	0.039	4920	92	148	0.27	460	X011b	
IXTQ 76N25T		76	0.039	4920	92	148	0.27	460	X017a	
IXTH 86N25T		86	0.037	5330	105	156	0.23	540	X014a	
IXTQ 86N25T		86	0.037	5330	105	156	0.23	540	X017a	
IXTH 96N25T		96	0.029	6100	114	158	0.2	625	X014a	
IXTQ 96N25T		96	0.029	6100	114	158	0.2	625	X017a	
IXTH 110N25T		110	0.024	9400	157	170	0.18	694	X014a	



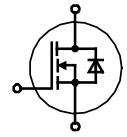





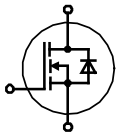

Trench HiPerFETs with Fast Intrinsic Diode



Part Type	V _{DSS}	I _{D(cont)} Chip T _C = 25°C	R _{DS(on)} T _C = 25°C	C _{iss} typ.	Q _g typ.	t _{rr} max. (typ.)	R _{thJC}	P _D	Fig. No.	Package style Outline drawings on pages O-31...O-52
➤ New	V	A	Ω	pF	nC	ns	K/W	W		
IXFA 130N10T	100	130	0.0091	5080	104	67	0.42	360	X011b	D5 DE 475 X005a TO-220AB
IXFP 130N10T		130	0.0091	5080	104	67	0.42	360	X005a	
IXFH 230N10T		230	0.0047	15300	250	(82)	0.23	650	X014a	
IXFX 360N10T		360	0.0029	33000	525	130	0.12	1250	X015a	
IXFN 360N10T		360	0.0026	33000	525	130	0.18	830	X027a	
IXFK 360N10T		360	0.0029	33000	525	130	0.12	1250	X020a	
IXFX 420N10T		420	0.0026	47000	670	140	0.09	1670	X015a	
IXFN 420N10T		420	0.0023	47000	670	140	0.14	1070	X027a	
IXFK 420N10T		420	0.0026	47000	670	140	0.09	1670	X020a	
IXFA 102N15T	150	102	0.018	5220	87	120	0.33	455	X011b	X011b TO-263AB
IXFH 102N15T		102	0.018	5220	87	120	0.33	455	X014a	
IXFP 102N15T		102	0.018	5220	87	120	0.33	455	X005a	
IXFH 160N15T		160	0.0096	8800	160	90	0.18	830	X014a	
IXFH 150N20T	200	150	0.015	11700	177	(100)	0.14	890	X014a	X014a TO-247AD X015a PLUS247 X016a ISOPLUS247™ X019 TO-268AA
IXFT 150N20T		150	0.015	11700	177	(100)	0.14	890	X019	
IXFR 230N20T		156	0.008	28000	378	200	0.25	600	X016a	
IXFX 170N20T		170	0.011	19600	265	200	0.13	1150	X015a	
IXFK 170N20T		170	0.011	19600	265	200	0.13	1150	X020a	
IXFN 230N20T		220	0.0075	28000	378	200	0.138	1090	X027a	
IXFX 230N20T		230	0.0075	28000	378	200	0.09	1670	X015a	
IXFK 230N20T		230	0.0075	28000	378	200	0.9	1670	X020a	
IXFZ 140N25T	250	100	0.017	19000	255	200	0.28	445	D5	
IXFH 110N25T		110	0.024	9400	157	170	0.18	694	X014a	
IXFH 120N25T		120	0.023	11300	180	(108)	0.14	890	X014a	
IXFT 120N25T		120	0.023	11300	180	(108)	0.14	890	X019	
IXFN 140N25T		120	0.017	19000	255	200	0.18	690	X027a	
IXFX 140N25T		140	0.017	19000	255	200	0.13	960	X015a	
IXFK 140N25T		140	0.017	19000	255	200	0.13	960	X020a	
IXFN 180N25T		164	0.0129	28000	345	200	0.138	900	X027a	
IXFX 180N25T		180	0.0129	28000	345	200	0.09	1390	X015a	
IXFK 180N25T		180	0.0129	28000	345	200	0.09	1390	X020a	
➤ IXFH 46N30T	300	46	0.08	4770	86	150	0.27	460	X014a	X020a TO-264 X027a SOT-227B miniBLOC
➤ IXFT 46N30T		46	0.08	4770	86	150	0.27	460	X019	
IXFH 86N30T		86	0.043	11300	180	150	0.15	830	X014a	
IXFT 86N30T		86	0.043	11300	180	150	0.15	830	X019	
IXFH 94N30T		94	0.036	11400	190	(155)	0.14	890	X014a	
IXFT 94N30T		94	0.036	11400	190	(155)	0.14	890	X019	
IXFX 120N30T		120	0.024	20000	265	200	0.13	960	X015a	
IXFK 120N30T		120	0.024	20000	265	200	0.13	960	X020a	
IXFN 160N30T		130	0.019	28000	335	200	0.138	900	X027a	
IXFX 160N30T		160	0.019	28000	335	200	0.09	1390	X015a	
IXFK 160N30T		160	0.019	28000	335	200	0.09	1390	X020a	

TrenchT2™ Power MOSFETs





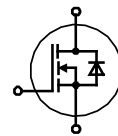

Part Type	V _{DSS}	I _{D(cont)} Chip T _C = 25°C	R _{DS(on)} T _C = 25°C	C _{iss} typ.	Q _g typ.	t _{rr} typ.	R _{thJC}	P _D	Fig. No.	Package style Outline drawings on pages O-31...O-52
➤ New	V	A	Ω	pF	nC	ns	K/W	W		
IXTP 100N04T2	40	100	0.007	2690	25.5	34	1	150	X005a	D5 DE 475 
IXTA 100N04T2		100	0.007	2690	25.5	34	1	150	X011b	
IXTP 120N04T2		120	0.0061	3240	58	35	0.75	200	X005a	
IXTA 120N04T2		120	0.0061	3240	58	35	0.75	200	X011b	
IXTP 160N04T2		160	0.005	4640	79	40	0.6	250	X005a	X004 TO-252AA 
IXTA 160N04T2		160	0.005	4640	79	40	0.6	250	X011b	
IXTP 220N04T2		220	0.0035	6820	112	45	0.42	360	X005a	
IXTA 220N04T2		220	0.0035	6820	112	45	0.42	360	X011b	
IXTP 300N04T2		300	0.0025	10700	145	53	0.31	480	X005a	X005a TO-220AB 
IXTH 300N04T2		300	0.0025	10700	145	53	0.31	480	X014a	
IXTA 300N04T2		300	0.0025	10700	145	53	0.31	480	X011b	
IXTH 420N04T2		420	0.002	19700	315	74	0.16	935	X014a	
IXTH 500N04T2		500	0.0016	25000	405	84	0.15	1000	X014a	X019
IXTT 500N04T2		500	0.0016	25000	405	84	0.15	1000	X019	
IXTX 600N04T2		600	0.0015	40000	590	100	0.12	1250	X015a	
IXTN 600N04T2		600	0.00105	40000	590	100	0.16	940	X027a	
IXTK 600N04T2	600	0.0015	40000	590	100	0.12	1250	X020a	X011b TO-263AB 	
IXTA 90N055T2	55	90	0.0084	2770	42	37	1	150		X011b
IXTP 90N055T2		90	0.0084	2770	42	37	1	150		X005a
IXTY 90N055T2		90	0.0084	2770	42	37	1	150		X004
IXTP 110N055T2		110	0.0066	3060	57	38	0.82	180	X005a	
IXTA 110N055T2		110	0.0066	3060	57	38	0.82	180	X011b	
IXTP 140N055T2		140	0.0054	4760	82	40	0.6	250	X005a	X014a TO-247AD 
IXTA 140N055T2		140	0.0054	4760	82	40	0.6	250	X011b	
IXTP 200N055T2		200	0.0042	6970	109	49	0.42	360	X005a	
IXTA 200N055T2		200	0.0042	6970	109	49	0.42	360	X011b	
IXTP 260N055T2		260	0.0033	10800	140	60	0.31	480	X005a	X015a PLUS247 
IXTH 260N055T2		260	0.0033	10800	140	60	0.31	480	X014a	
IXTA 260N055T2		260	0.0033	10800	140	60	0.31	480	X011b	
IXTH 360N055T2		360	0.0024	20000	330	78	0.16	935	X014a	
IXTT 360N055T2		360	0.0024	20000	330	78	0.16	935	X019	X019 TO-268AA 
IXTH 440N055T2		440	0.0018	25000	405	76	0.15	1000	X014a	
IXTT 440N055T2		440	0.0018	25000	405	76	0.15	1000	X019	
IXTX 550N055T2	550	0.0016	40000	595	100	0.12	1250	X015a		
IXTN 550N055T2	550	0.0013	40000	595	100	0.16	940	X027a	X020a	
IXTK 550N055T2	550	0.0016	40000	595	100	0.12	1250	X020a		
IXTZ 550N055T2		550	0.001	40000	595	100	0.25	600	D5	
IXTP 130N065T2	65	130	0.0066	4800	79	41	0.6	250	X005a	X020a TO-264 
IXTA 130N065T2		130	0.0066	4800	79	41	0.6	250	X011b	
IXTP 70N075T2	75	70	0.012	2580	46	48	1	150	X005a	X027a SOT-227B miniBLOC 
IXTA 70N075T2		70	0.012	2580	46	48	1	150	X011b	
IXTP 90N075T2		90	0.01	3290	54	50	0.82	180	X005a	
IXTA 90N075T2		90	0.01	3290	54	50	0.82	180	X011b	
IXTP 120N075T2		120	0.0077	4740	78	50	0.6	250	X005a	
IXTA 120N075T2		120	0.0077	4740	78	50	0.6	250	X011b	
IXTP 170N075T2		170	0.0054	6860	109	63	0.42	360	X005a	
IXTA 170N075T2		170	0.0054	6860	109	63	0.42	360	X011b	
IXTP 230N075T2		230	0.0042	10.5	178	66	0.31	480	X005a	
IXTA 230N075T2		230	0.0042	10.5	178	66	0.31	480	X011b	
IXTP 80N12T2	120	80	0.017	4740	80	90	0.46	325	X005a	
IXTA 80N12T2		80	0.017	4740	80	90	0.46	325	X011b	







TrenchT2™ in SMPD Package

Part Type	V _{DSS}	I _{D(cont)} Chip T _C = 25°C	R _{DS(on)} T _C = 25°C	C _{iss} typ.	Q _g typ.	t _{rr} typ.	R _{thJC}	P _D	Fig. No.	Package style Outline drawings on pages O-31...O-52
➤ New	V	A	Ω	pF	nC	ns	K/W	W		
➤ MMIX 1T600N04T2	40	600	0.0013	40000	590	100	0.18	830	X031a	 SMPD-X
➤ MMIX 1T550N055T2	55	550	0.0013	40000	595	100	0.18	830		
➤ MMIX 1F520N075T2	75	500	0.0016	41000	545	150	0.18	830		

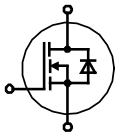

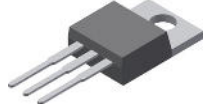
TrenchT2™ HiPerFETs

IXFP 230N075T2	75	230	0.0042	10500	178	59	0.31	480	X007a	 DE 475		
IXFH 230N075T2		230	0.0042	10500	178	59	0.31	480	X014a			
IXFA 230N075T2		230	0.0042	10500	178	59	0.31	480	X011b			
IXFH 340N075T2		340	0.0032	19000	300	75	0.16	935	X014a			
IXFT 340N075T2		340	0.0032	19000	300	75	0.16	935	X019			
IXFH 400N075T2		400	0.0023	24000	420	77	0.15	1000	X014a			
IXFT 400N075T2		400	0.0023	24000	420	77	0.15	1000	X019			
IXFZ 520N075T2		465	0.0013	41000	545	n/a	0.25	600	D5	 TO-220FPAB		
IXFN 520N075T2		480	0.0019	41000	545	n/a	0.16	940	X027a			
IXFX 520N075T2		520	0.0022	41000	545	n/a	0.12	1250	X015a			
IXFK 520N075T2		520	0.0022	41000	545	n/a	0.12	1250	X020a			
IXFP 130N10T2	100	130	0.0091	6600	130	n/a	0.42	360	X007a	 TO-263AB		
IXFA 130N10T2		130	0.0091	6600	130	n/a	0.42	360	X011b			
IXFP 180N10T2		180	0.006	10500	185	66	0.31	480	X007a			
IXFA 180N10T2		180	0.006	10500	185	66	0.31	480	X011b			
IXFH 320N10T2		320	0.0035	25000	430	98	0.15	1000	X014a			
IXFT 320N10T2		320	0.0035	26000	430	98	0.15	1000	X019			
IXFP 76N15T2		150	76	0.02	5800	97	69	0.43	350		X007a	 PLUS247
IXFA 76N15T2	76		0.02	5800	97	69	0.43	350	X011b			
IXFP 110N15T2	110		0.013	8600	150	85	0.31	480	X007a			
IXFH 110N15T2	110		0.013	8600	150	85	0.31	480	X014a			
IXFA 110N15T2	110		0.013	8600	150	85	0.31	480	X011b			
IXFH 160N15T2	160		0.009	15000	253	n/a	0.17	880	X014a			
IXFX 240N15T2	240		0.0052	32000	460	n/a	0.12	1250	X015a			
IXFN 240N15T2	240		0.0052	32000	460	n/a	0.18	830	X027a			
IXFK 240N15T2	240		0.0052	32000	460	n/a	0.12	1250	X020a			
IXFN 360N15T2	310		0.004	47500	715	n/a	0.14	1070	X027a			
IXFX 360N15T2	360		0.004	47500	715	n/a	0.09	1670	X015a			
IXFK 360N15T2	360		0.004	47500	715	n/a	0.09	1670	X020a			
IXFX 220N17T2	170		220	0.0063	31000	500	n/a	0.12	1250	X015a	 TO-268AA	
IXFK 220N17T2			220	0.0063	31000	500	n/a	0.12	1250	X020a		
IXFN 320N17T2		260	0.0052	45000	640	n/a	0.14	1070	X027a			
IXFX 320N17T2		320	0.0052	45000	640	n/a	0.09	1670	X015a			
IXFK 320N17T2		320	0.0052	45000	640	n/a	0.09	1670	X020a			
IXFH 150N17T2		175	150	0.012	14600	233	n/a	0.17	880	X014a		 TO-264
IXFT 150N17T2	150		0.012	14600	233	n/a	0.17	880	X019			
									X027a	 SOT-227B miniBLOC		



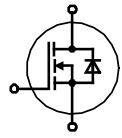





Part Type	V _{DSS}	I _{D(cont)} Chip T _J = 25°C	R _{DS(on)} T _J = 25°C	C _{iss} typ	Q _g typ	t _{rr} typ	R _{thJC}	P _D	Fig. No.	Package style Outline drawings on pages O-31...O-52
➤ New	V	A	Ω	pF	nC	ns	K/W	W		
IXTP 75N10P	100	75	0.025	2250	74	120	0.42	360	X005a	X005a TO-220AB 
IXTA 75N10P		75	0.025	2250	74	120	0.42	360	X011b	
IXTQ 75N10P		75	0.025	2250	74	120	0.42	360	X017a	
IXTT 110N10P		110	0.015	3550	110	130	0.31	480	X019	
IXTQ 110N10P		110	0.015	3550	110	130	0.31	480	X017a	
IXTR 200N10P		120	0.008	7600	235	100	0.5	300	X016a	
IXTT 140N10P		140	0.011	4700	155	120	0.25	600	X019	
IXTQ 140N10P		140	0.011	4700	155	120	0.25	600	X017a	
IXTK 170N10P		170	0.009	6000	198	120	0.21	715	X020a	
IXTT 170N10P		170	0.009	6000	198	120	0.21	715	X019	
IXTQ 170N10P	170	0.009	6000	198	120	0.21	715	X017a		
IXTK 200N10P	200	0.0075	7600	240	100	0.18	800	X020a	X011b TO-263AB 	
IXTP 62N15P	150	62	0.04	2250	70	150	0.42	350	X005a	X014a TO-247AD 
IXTA 62N15P		62	0.04	2250	70	150	0.42	350	X011b	
IXTQ 62N15P		62	0.04	2250	70	150	0.42	350	X017a	
IXTT 96N15P		96	0.024	3500	110	150	0.31	480	X019	
IXTQ 96N15P		96	0.024	3500	110	150	0.31	480	X017a	
IXTT 120N15P		120	0.016	4900	150	150	0.25	600	X019	
IXTQ 120N15P		120	0.016	4900	150	150	0.25	600	X017a	
IXTK 150N15P		150	0.013	5800	190	150	0.21	714	X020a	
IXTQ 150N15P		150	0.013	5800	190	150	0.21	714	X017a	
IXTK 180N15P		180	0.01	7000	240	150	0.18	800	X020a	
IXTP 50N20P	200	50	0.06	2720	70	150	0.42	360	X005a	X016a ISOPLUS247™ 
IXTA 50N20P		50	0.06	2720	70	150	0.42	360	X011b	
IXTQ 50N20P		50	0.06	2720	70	150	0.42	360	X017a	
IXTT 74N20P		74	0.034	3300	107	160	0.31	480	X019	
IXTQ 74N20P		74	0.034	3300	107	160	0.31	480	X017a	
IXTH 96N20P		96	0.024	4800	145	160	0.25	600	X014a	
IXTT 96N20P		96	0.024	4800	145	160	0.25	600	X019	
IXTQ 96N20P		96	0.024	4800	145	160	0.25	600	X017a	
IXTK 120N20P		120	0.022	6000	152	180	0.21	714	X020a	
IXTQ 120N20P		120	0.022	6000	152	180	0.21	714	X017a	
IXTK 140N20P		140	0.018	7500	240	180	0.18	800	X020a	
IXTP 42N25P		250	42	0.084	2300	70	200	0.42	300	
IXTA 42N25P	42		0.084	2300	70	200	0.42	300	X011b	
IXTQ 42N25P	42		0.084	2300	70	200	0.42	300	X017a	
IXTT 64N25P	64		0.049	3450	105	200	0.31	400	X019	
IXTQ 64N25P	64		0.049	3450	105	200	0.31	400	X017a	
IXTK 82N25P	82		0.035	4800	142	200	0.25	500	X020a	
IXTT 82N25P	82		0.035	4800	142	200	0.25	500	X019	
IXTQ 82N25P	82		0.035	4800	142	200	0.25	500	X017a	
IXTK 100N25P	100		0.027	6300	185	200	0.21	600	X020a	
IXTT 100N25P	100		0.027	6300	185	200	0.21	600	X019	
IXTQ 100N25P	100		0.027	6300	185	200	0.21	600	X017a	
IXTK 120N25P	120		0.024	8700	185	200	0.18	700	X020a	
IXTP 36N30P	300	36	0.11	2250	70	250	0.42	300	X005a	X020a TO-264 
IXTA 36N30P		36	0.11	2250	70	250	0.42	300	X011b	
IXTQ 36N30P		36	0.11	2250	70	250	0.42	300	X017a	
IXTT 52N30P		52	0.066	3490	110	250	0.31	400	X019	
IXTQ 52N30P		52	0.066	3490	110	250	0.31	400	X017a	
IXTT 69N30P		69	0.049	4960	156	330	0.25	500	X019	
IXTQ 69N30P		69	0.049	4960	156	330	0.25	500	X017a	
IXTH 88N30P		88	0.04	6300	180	250	0.21	600	X014a	
IXTK 88N30P		88	0.04	6300	180	250	0.21	600	X020a	
IXTT 88N30P		88	0.04	6300	180	250	0.21	600	X019	
IXTQ 88N30P		88	0.04	6300	180	250	0.21	600	X017a	
IXTK 102N30P		102	0.033	7500	224	250	0.18	700	X020a	
IXTK 140N30P		140	0.24	14800	185	250	0.12	1040	X020a	

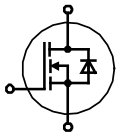

Part Type	V _{DSS} V	I _{D(cont)} Chip T _C = 25°C A	R _{DS(on)} T _J = 25°C Ω	C _{iss} typ pF	Q _g typ nC	t _{rr} typ ns	R _{thJC} K/W	P _D W	Fig. No.	Package style Outline drawings on pages O-31...O-52
IXTP 12N50P	500	12	0.5	1830	29	300	0.62	200	X005a	X004 TO-252AA 
IXTA 12N50P		12	0.5	1830	29	300	0.62	200	X011b	
IXTP 16N50P		16	0.4	2480	43	400	0.42	300	X005a	
IXTA 16N50P		16	0.4	2480	43	400	0.42	300	X011b	
IXTQ 16N50P		16	0.4	2480	43	400	0.42	300	X017a	
IXTH 22N50P		22	0.27	2880	50	400	0.35	350	X014a	
IXTQ 22N50P		22	0.27	2880	50	400	0.35	350	X017a	
IXTT 26N50P		26	0.23	3600	65	300	0.31	400	X019	
IXTQ 26N50P		26	0.23	3600	65	300	0.31	400	X017a	
IXTH 30N50P		30	0.2	4150	70	400	0.27	460	X014a	
IXTT 30N50P		30	0.2	4150	70	400	0.27	460	X019	
IXTQ 30N50P		30	0.2	4150	70	400	0.27	460	X017a	
IXTH 36N50P		36	0.17	4700	82	400	0.23	540	X014a	
IXTT 36N50P		36	0.17	4700	82	400	0.23	540	X019	
IXTQ 36N50P		36	0.17	4700	82	400	0.23	540	X017a	
IXTQ 44N50P		44	0.14	5440	98	400	0.19	650	X017a	
IXTP 10N60P	600	10	0.74	1720	32	500	0.62	200	X005a	X005a TO-220AB 
IXTA 10N60P		10	0.74	1720	32	500	0.62	200	X011b	
IXTP 14N60P		14	0.55	2500	36	500	0.42	300	X005a	
IXTA 14N60P		14	0.55	2500	36	500	0.42	300	X011b	
IXTQ 14N60P		14	0.55	2500	36	500	0.42	300	X017a	
IXTQ 18N60P		18	0.42	2500	49	500	0.35	360	X017a	
IXTQ 22N60P		22	0.35	3600	62	500	0.31	400	X017a	
IXTH 26N60P		26	0.27	4150	72	500	0.27	460	X014a	
IXTT 26N60P		26	0.27	4150	72	500	0.27	460	X019	
IXTQ 26N60P		26	0.27	4150	72	500	0.27	460	X017a	
IXTH 30N60P		30	0.24	5050	82	500	0.23	540	X014a	
IXTT 30N60P		30	0.24	5050	82	500	0.23	540	X019	
IXTQ 30N60P	30	0.24	5050	82	500	0.23	540	X017a		
IXTP 05N100P	1000	0.5	30	196	8.1	750	2.5	50	X005a	X014a TO-247AD 
IXTA 05N100P		0.5	30	196	8.1	750	2.5	50	X011b	
IXTP 08N100P		0.8	20	240	11.3	750	3.0	42	X005a	
IXTY 08N100P		0.8	20	240	11.3	750	3.0	42	X004	
IXTA 08N100P		0.8	20	240	11.3	750	3.0	42	X011b	
IXTP 1N100P		1	15	331	15.5	750	2.5	50	X005a	
IXTY 1N100P		1	15	331	15.5	750	2.5	50	X004	
IXTA 1N100P		1	15	331	15.5	750	2.5	50	X011b	
IXTP 1R4N100P		1.4	11	450	17.8	750	2.0	63	X005a	
IXTY 1R4N100P		1.4	11	450	17.8	750	2.0	63	X004	
IXTA 1R4N100P		1.4	11	666	17.8	750	2.0	63	X011b	
IXTP 2N100P		2	7.5	655	24.3	800	1.45	86	X005a	
IXTY 2N100P		2	7.5	655	24.3	800	1.45	86	X004	
IXTA 2N100P		2	7.5	655	24.3	800	1.45	86	X011b	
IXTP 3N100P		3	4.8	1100	39	820	1.0	125	X005a	
IXTH 3N100P		3	4.8	1100	39	820	1.0	125	X014a	
IXTA 3N100P		3	4.8	1100	39	820	1.0	125	X011b	
IXTP 02N120P		1200	0.2	75	104	4.7	1600	3.8	33	
IXTY 02N120P	0.2		75	104	4.7	1600	3.8	33	X004	
IXTP 06N120P	0.6		34	236	13.3	900	3.0	42	X005a	
IXTA 06N120P	0.6		34	236	13.3	900	3.0	42	X011b	
IXTP 08N120P	0.8		25	333	14	900	2.5	50	X005a	
IXTA 08N120P	0.8		25	333	14	900	2.5	50	X011b	
IXTP 1N120P	1		20	445	17.6	900	2.0	63	X005a	
IXTA 1N120P	1		20	445	17.6	900	2.0	63	X011b	
IXTP 1R4N120P	1.4		13	666	24.8	900	1.45	86	X005a	
IXTA 1R4N120P	1.4		13	725	24.8	900	1.45	86	X011b	
IXTP 2R4N120P	2.4		7.5	1207	37	920	1.0	125	X005a	
IXTH 2R4N120P	2.4		7.5	1207	37	920	1.0	125	X014a	
IXTA 2R4N120P	2.4		7.5	1207	37	920	1.0	125	X011b	

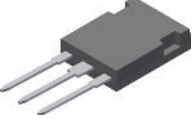







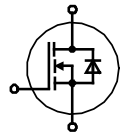







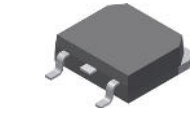
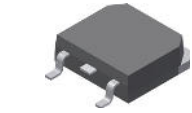
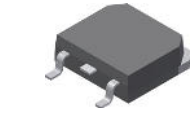

Polar™ HiPerFETs with Fast Intrinsic Diode



Part Type	V _{DSS} V	I _{D(cont)} Chip T _C = 25°C A	R _{DS(on)} T _J = 25°C Ω	C _{iss} typ pF	Q _g typ nC	t _{rr} typ ns	R _{thJC} K/W	P _D W	Fig. No.	Package style Outline drawings on pages O-31...O-52	
IXFH 110N10P	100	110	0.015	3550	110	150	0.31	480	X014a	X014a TO-247AD 	
IXFR 200N10P		133	0.009	7600	235	150	0.5	300	X016a		
IXFH 140N10P		140	0.011	4700	155	150	0.25	600	X014a		
IXFT 140N10P		140	0.011	4700	155	150	0.25	600	X019		
IXFH 170N10P		170	0.009	6000	198	150	0.21	715	X014a		
IXFK 170N10P		170	0.009	6000	198	150	0.21	715	X020a		
IXFX 200N10P		200	0.0075	7600	235	150	0.18	830	X015a		
IXFN 200N10P		200	0.0075	7600	235	150	0.22	680	X027a		
IXFK 200N10P		200	0.0075	7600	235	150	0.18	830	X020a		
IXFX 250N10P		250	0.0065	16000	205	200	0.12	1250	X015a		
IXFK 250N10P		250	0.0065	16000	205	200	0.12	1250	X020a		
IXFN 300N10P		295	0.0055	23	279	200	0.14	1070	X027a		
IXFB 300N10P		300	0.0055	23	279	200	0.10	1500	X021a		
IXFH 96N15P	150	96	0.024	3500	110	200	0.31	480	X014a	X015a PLUS247 	
IXFR 180N15P		100	0.013	7000	240	200	0.5	300	X016a		
IXFH 120N15P		120	0.016	4900	150	200	0.25	600	X014a		
IXFT 120N15P		120	0.016	4900	150	200	0.25	600	X019		
IXFN 180N15P		150	0.011	7000	240	200	0.22	680	X027a		
IXFH 150N15P		150	0.013	5800	190	200	0.21	714	X014a		
IXFK 150N15P		150	0.013	5800	190	200	0.21	714	X020a		
IXFX 180N15P		180	0.011	7000	240	200	0.18	830	X015a		
IXFK 180N15P		180	0.011	7000	240	200	0.18	830	X020a		
IXFX 220N15P		220	0.009	15.4	162	200	0.12	1250	X015a		
IXFK 220N15P		220	0.009	15.4	162	200	0.12	1250	X020a		
IXFH 74N20P	200	74	0.034	3300	107	200	0.31	480	X014a		X016a ISOPLUS247™ 
IXFR 140N20P		90	0.022	7500	240	200	0.50	300	X016a		
IXFH 96N20P		96	0.024	4800	145	200	0.25	600	X014a		
IXFT 96N20P		96	0.024	4800	145	200	0.25	600	X019		
IXFN 140N20P		115	0.018	7500	240	200	0.22	680	X027a		
IXFH 120N20P		120	0.022	6000	152	200	0.21	714	X014a		
IXFK 120N20P		120	0.022	6000	152	200	0.21	714	X020a		
IXFK 140N20P		140	0.018	7500	240	200	0.18	830	X020a		
IXFX 170N20P		170	0.014	11.4	185	200	0.12	1250	X015a		
IXFK 170N20P		170	0.014	11.4	185	200	0.12	1250	X020a		
IXFN 210N20P		188	0.0105	18.6	255	200	0.14	1070	X027a		
IXFB 210N20P		210	0.0105	18.6	255	200	0.10	1500	X021a		
IXFH 100N25P	250	100	0.027	6300	185	200	0.21	600	X014a	X019 TO-268AA 	
IXFX 120N25P		120	0.024	8700	185	200	0.18	700	X015a		
IXFK 120N25P		120	0.024	8700	185	200	0.18	700	X020a		
IXFH 52N30P	300	52	0.066	3490	110	200	0.31	400	X014a		X020a TO-264 
IXFR 102N30P		60	0.036	7500	224	200	0.50	250	X016a		
IXFH 69N30P		69	0.049	4960	156	200	0.25	500	X014a		
IXFT 69N30P		69	0.049	4960	156	200	0.25	500	X019		
IXFR 140N30P		70	0.026	14800	185	200	0.35	360	X016a		
IXFN 102N30P		86	0.033	7500	224	200	0.22	570	X027a		
IXFH 88N30P		88	0.04	6300	180	200	0.21	600	X014a		
IXFK 88N30P		88	0.04	6300	180	200	0.21	600	X020a		
IXFT 88N30P		88	0.04	6300	180	200	0.21	600	X019		
IXFK 102N30P		102	0.033	7500	224	200	0.18	700	X020a		
IXFN 140N30P		110	0.024	14800	185	200	0.18	700	X027a		
IXFN 170N30P		138	0.0018	20	258	200	0.14	890	X027a		
IXFX 140N30P		140	0.024	14800	185	200	0.12	1040	X015a		
IXFK 140N30P		140	0.024	14800	185	200	0.12	1040	X020a		
IXFB 170N30P		170	0.018	20	258	200	0.10	1250	X021a		
										X027a SOT-227B miniBLOC 	









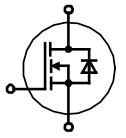















Polar™ HiPerFETs with Fast Intrinsic Diode



Part Type	V _{DSS} V	I _{D(cont)} Chip T _C = 25°C A	R _{DS(on)} T _J = 25°C Ω	C _{iss} typ pF	Q _g typ nC	t _{rr} typ ns	R _{thJC} K/W	P _D W	Fig. No.	Package style Outline drawings on pages O-31...O-52	
IXFP 12N50P	500	12	0.5	1830	29	200	0.62	200	X005a	X005a TO-220AB 	
IXFA 12N50P		12	0.5	1830	29	200	0.62	200	X011b		
IXFP 16N50P		16	0.4	2480	43	200	0.42	300	X005a		
IXFH 16N50P		16	0.4	2480	43	200	0.42	300	X014a		
IXFA 16N50P		16	0.4	2480	43	200	0.42	300	X011b		
IXFR 36N50P		19	0.19	5500	93	200	0.75	156	X016a		X011b TO-263AB 
IXFH 22N50P		22	0.27	2880	50	200	0.35	350	X014a		
IXFR 44N50P		24	0.15	5440	98	200	0.6	208	X016a		X014a TO-247AD 
IXFH 26N50P		26	0.23	3600	60	200	0.31	400	X014a		
IXFH 30N50P		30	0.2	4150	70	200	0.27	460	X014a		
IXFT 30N50P	30	0.2	4150	70	200	0.27	460	X019			
IXFH 36N50P	36	0.17	5500	93	200	0.23	540	X014a	X014a TO-247AD 		
IXFT 36N50P	36	0.17	5500	93	200	0.23	540	X019			
IXFR 64N50P	37	0.095	9700	150	200	0.42	300	X016a	X015a PLUS247 		
IXFH 44N50P	44	0.14	5440	98	200	0.19	650	X014a			
IXFK 44N50P	44	0.14	5440	98	200	0.19	650	X020a			
IXFT 44N50P	44	0.14	5440	98	200	0.19	650	X019			
IXFR 80N50P	45	0.072	12700	197	200	0.35	360	X016a	X016a ISOPLUS247™ 		
IXFN 64N50P	50	0.085	9700	150	200	0.2	625	X027a			
IXFX 64N50P	64	0.085	9700	150	200	0.15	830	X015a	X016a ISOPLUS247™ 		
IXFK 64N50P	64	0.085	9700	150	200	0.15	830	X020a			
IXFN 80N50P	66	0.065	12700	195	200	0.18	700	X027a	X019 TO-268AA 		
IXFL 100N50P	70	0.052	20000	240	200	0.2	625	X022a			
IXFX 80N50P	80	0.065	12700	197	200	0.12	1040	X015a	X019 TO-268AA 		
IXFK 80N50P	80	0.065	12700	197	200	0.12	1040	X020a			
IXFN 100N50P	90	0.049	20000	240	200	0.12	1040	X027a	X019 TO-268AA 		
IXFB 100N50P	100	0.049	20000	240	200	0.1	1250	X021a			
IXFP 10N60P	600	10	0.74	1720	32	200	0.62	200	X005a	X020a TO-264 	
IXFA 10N60P		10	0.74	1720	32	200	0.62	200	X011b		
IXFP 14N60P		14	0.55	2500	36	200	0.42	300	X005a		
IXFH 14N60P		14	0.55	2500	36	200	0.42	300	X014a		
IXFA 14N60P		14	0.55	2500	36	200	0.42	300	X011b		
IXFR 30N60P		15	0.25	3820	85	200	0.75	166	X016a		X021a PLUS264 
IXFH 18N60P		18	0.4	2500	50	200	0.35	360	X014a		
IXFR 36N60P		20	0.2	5800	102	200	0.6	208	X016a		X021a PLUS264 
IXFH 22N60P		22	0.35	3600	58	200	0.31	400	X014a		
IXFH 26N60P		26	0.27	4150	72	200	0.27	460	X014a		X022a ISOPLUS264™ 
IXFT 26N60P	26	0.27	4150	72	200	0.27	460	X019			
IXFH 30N60P	30	0.24	4000	82	200	0.25	500	X014a	X027a SOT-227B miniBLOC 		
IXFT 30N60P	30	0.24	4000	82	200	0.25	500	X019			
IXFR 48N60P	32	0.15	8860	150	200	0.42	300	X016a	X022a ISOPLUS264™ 		
IXFR 64N60P	36	0.105	12000	200	200	0.35	360	X016a			
IXFH 36N60P	36	0.19	5800	102	200	0.19	650	X014a	X027a SOT-227B miniBLOC 		
IXFK 36N60P	36	0.19	5800	102	200	0.19	650	X020a			
IXFT 36N60P	36	0.19	5800	102	200	0.19	650	X019	X027a SOT-227B miniBLOC 		
IXFN 48N60P	40	0.14	8860	150	200	0.2	625	X027a			
IXFX 48N60P	48	0.135	8860	150	200	0.15	830	X015a	X027a SOT-227B miniBLOC 		
IXFK 48N60P	48	0.135	8860	150	200	0.15	830	X020a			
IXFN 64N60P	50	0.096	12000	200	200	0.18	700	X027a	X027a SOT-227B miniBLOC 		
IXFL 82N60P	54	0.08	23000	240	200	0.2	625	X022a			
IXFX 64N60P	64	0.096	12000	200	200	0.12	1040	X015a	X027a SOT-227B miniBLOC 		
IXFK 64N60P	64	0.096	12000	200	200	0.12	1040	X020a			
IXFB 82N60P	82	0.075	23000	240	200	0.1	1250	X021a	X027a SOT-227B miniBLOC 		
IXFN 82N60P	82	0.75	23000	240	200	0.12	1040	X027a			







Polar™ HiPerFETs with Fast Intrinsic Diode

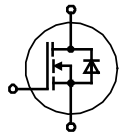

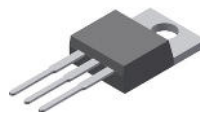
Part Type	V _{DSS} V	I _{D(cont)} Chip T _C = 25°C A	R _{DS(on)} T _J = 25°C Ω	C _{iss} typ pF	Q _g typ nC	t _{rr} typ ns	R _{thJC} K/W	P _D W	Fig. No.	Package style Outline drawings on pages O-31...O-52
IXFP 7N80P	800	7	1.44	1800	32	250	0.62	200	X005a	X005a TO-220AB 
IXFA 7N80P		7	1.44	1800	32	250	0.62	200	X011b	
IXFR 20N80P		10	0.57	4685	86	250	0.8	160	X016a	X011b TO-263AB 
IXFP 10N80P		10	1.1	2050	40	250	0.42	300	X005a	
IXFH 10N80P		10	1.1	2050	40	250	0.42	300	X014a	X014a TO-247AD 
IXFA 10N80P		10	1.1	2050	40	250	0.42	300	X011b	
IXFQ 10N80P		10	1.1	2050	40	250	0.42	300	X017a	X014a TO-247AD 
IXFH 12N80P		12	0.85	2800	51	250	0.35	360	X014a	
IXFQ 12N80P		12	0.85	2800	51	250	0.35	360	X017a	X015a PLUS247 
IXFR 24N80P		13	0.42	7200	105	250	0.6	208	X016a	
IXFH 14N80P		14	0.72	3900	61	250	0.31	400	X014a	X016a ISOPLUS247™ 
IXFT 14N80P		14	0.72	3900	61	250	0.31	400	X019	
IXFQ 14N80P		14	0.72	3900	61	250	0.31	400	X017a	X016a ISOPLUS247™ 
IXFH 16N80P		16	0.6	4000	70	250	0.27	460	X014a	
IXFT 16N80P		16	0.6	4000	70	250	0.27	460	X019	X019 TO-268AA 
IXFR 32N80P		20	0.29	8800	150	250	0.42	300	X016a	
IXFH 20N80P		20	0.52	4685	86	250	0.25	500	X014a	X020a TO-264 
IXFT 20N80P		20	0.52	4685	86	250	0.25	500	X019	
IXFH 24N80P		24	0.4	5800	100	250	0.19	650	X014a	X021a PLUS264 
IXFK 24N80P		24	0.4	7200	105	250	0.19	650	X020a	
IXFT 24N80P		24	0.4	5800	100	250	0.19	650	X019	X022a ISOPLUS264™ 
IXFR 44N80P		26	0.19	12000	200	250	0.35	360	X016a	
IXFN 32N80P		29	0.27	8820	150	250	0.2	625	X027a	X027a SOT-227B miniBLOC 
IXFX 32N80P		32	0.27	8800	150	250	0.15	830	X015a	
IXFK 32N80P		32	0.27	8800	150	250	0.15	830	X020a	X027a SOT-227B miniBLOC 
IXFN 44N80P		36	0.19	12000	200	250	0.12	1200	X027a	
IXFL 60N80P		40	0.15	18000	250	250	0.2	625	X022a	X027a SOT-227B miniBLOC 
IXFX 44N80P		44	0.19	12000	198	250	0.12	1200	X015a	
IXFK 44N80P		44	0.19	12000	198	250	0.12	1200	X020a	X027a SOT-227B miniBLOC 
IXFN 60N80P		53	0.14	18000	250	250	0.12	1040	X027a	
IXFB 60N80P		60	0.14	18000	250	250	0.1	1250	X021a	X027a SOT-227B miniBLOC 
IXFR 18N90P	900	10.5	0.66	5230	97	300	0.62	200	X016a	
IXFH 12N90P		12	0.9	3080	56	300	0.33	380	X014a	X021a PLUS264 
IXFR 24N90P		13	0.46	7200	130	300	0.54	230	X016a	
IXFH 18N90P		18	0.6	5230	97	300	0.23	540	X014a	X022a ISOPLUS264™ 
IXFT 18N90P		18	0.6	5230	97	300	0.23	540	X019	
IXFR 40N90P		21	0.23	14000	230	300	0.42	300	X016a	X027a SOT-227B miniBLOC 
IXFH 24N90P		24	0.42	7200	130	300	0.19	660	X014a	
IXFT 24N90P		24	0.42	7200	130	300	0.19	660	X019	X027a SOT-227B miniBLOC 
IXFK 32N90P		32	0.3	10600	215	300	0.13	960	X020a	
IXFX 32N90P		32	0.3	10600	215	300	0.13	960	X015a	X027a SOT-227B miniBLOC 
IXFN 40N90P		33	0.21	14000	230	300	0.18	695	X027a	
IXFX 40N90P		40	0.21	14000	230	300	0.13	960	X015a	X027a SOT-227B miniBLOC 
IXFK 40N90P		40	0.21	14000	230	300	0.13	960	X020a	
IXFN 52N90P		43	0.16	19000	308	300	0.14	890	X027a	X027a SOT-227B miniBLOC 
IXFB 52N90P		52	0.16	19000	308	300	0.1	1250	X021a	
IXFN 56N90P		56	0.145	23000	375	300	0.125	1000	X027a	X027a SOT-227B miniBLOC 

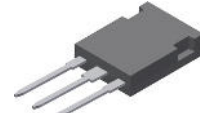

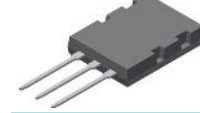



Polar™ HiPerFETs with Fast Intrinsic Diode

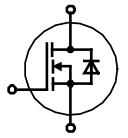



Part Type	V _{DSS} V	I _{D(cont)} Chip T _C = 25°C A	R _{DS(on)} T _J = 25°C Ω	C _{iss} typ pF	Q _g typ nC	t _{rr} typ ns	R _{thJC} K/W	P _D W	Fig. No.	Package style Outline drawings on pages O-31...O-52
IXFP 4N100P	1000	4	3.3	1456	26	300	0.83	150	X005a	 TO-220AB
IXFA 4N100P		4	3.3	1456	26	300	0.83	150	X011b	
IXFP 5N100P		5	2.8	1830	33.4	200	0.5	250	X005a	
IXFH 5N100P		5	2.8	1830	33.4	200	0.5	250	X014a	
IXFA 5N100P		5	2.8	1830	33.4	200	0.5	250	X011b	
IXFA 7N100P		7	1.9	2590	47	300	0.42	300	X011b	
IXFH 7N100P		7	1.9	2590	47	300	0.42	300	X014a	
IXFP 7N100P		7	1.9	2590	47	300	0.42	300	X005a	
IXFH 10N100P		10	1.4	3030	56	300	0.33	380	X014a	
IXFR 20N100P	11	0.64	7300	126	300	0.54	230	X016a	 TO-247AD	
IXFH 12N100P	12	1.05	4080	80	300	0.27	463	X014a		
IXFR 26N100P	15	0.43	11900	197	300	0.43	290	X016a		
IXFH 15N100P	15	0.76	5140	97	300	0.23	543	X014a		
IXFR 32N100P	18	0.34	14200	225	300	0.39	320	X016a		
IXFH 20N100P	20	0.57	7300	126	300	0.19	660	X014a		
IXFT 20N100P	20	0.57	7300	126	300	0.19	660	X019		
IXFL 44N100P	22	0.24	19000	305	300	0.35	357	X022a		
IXFN 26N100P	23	0.39	11900	197	300	0.21	595	X027a		
IXFX 26N100P	26	0.39	11900	197	300	0.16	780	X015a	 ISOPLUS247™	
IXFK 26N100P	26	0.39	11900	197	300	0.16	780	X020a		
IXFN 32N100P	27	0.32	14200	225	300	0.18	690	X027a		
IXFL 38N100P	29	0.23	24000	350	300	0.24	520	X022e		
IXFX 32N100P	32	0.32	14200	225	300	0.13	960	X015a		
IXFK 32N100P	32	0.32	14200	225	300	0.13	960	X020a		
IXFN 44N100P	37	0.22	19000	305	300	0.14	890	X027a		
IXFN 38N100P	38	0.21	24000	350	300	0.125	1000	X027a		
IXFB 44N100P	44	0.22	19000	305	300	0.1	1250	X021a		
IXFL 40N110P	1100	21	0.28	19000	310	300	0.35	357	X022a	 TO-264
IXFL 36N110P		26	0.26	23000	350	300	0.24	520	X022a	
IXFN 40N110P		34	0.26	19000	310	300	0.14	890	X027a	
IXFB 40N110P		40	0.26	19000	310	300	0.1	1250	X021a	
IXFP 6N120P	1200	6	2.4	2830	92	300	0.5	250	X005a	 PLUS264
IXFH 6N120P		6	2.4	2830	92	300	0.5	250	X014a	
IXFA 6N120P		6	2.4	2830	92	300	0.5	250	X011b	
IXFR 16N120P		9	1.04	6900	120	300	0.54	230	X016a	
IXFH 12N120P		12	1.35	5400	103	300	0.23	543	X014a	
IXFR 20N120P		13	0.63	12900	193	300	0.43	290	X016a	
IXFR 26N120P		15	0.5	14000	225	300	0.39	320	X016a	
IXFH 16N120P		16	0.95	6900	120	300	0.19	660	X014a	
IXFT 16N120P		16	0.95	6900	120	300	0.19	660	X019	
IXFL 30N120P	18	0.38	19000	310	300	0.35	357	X022a	 ISOPLUS264/i5-pac	
IXFX 20N120P	20	0.57	11100	193	300	0.16	780	X015a		
IXFN 20N120P	20	0.57	11100	193	300	0.21	595	X027a		
IXFK 20N120P	20	0.57	11100	193	300	0.16	780	X020a		
IXFN 26N120P	23	0.46	14000	225	300	0.18	695	X027a		
IXFL 32N120P	24	0.34	21000	360	300	0.24	520	X022e		
IXFX 26N120P	26	0.46	14000	225	300	0.13	960	X015a		
IXFK 26N120P	26	0.46	14000	225	300	0.13	960	X020a		
IXFB 30N120P	30	0.35	22500	310	300	0.1	1250	X021a		
IXFN 30N120P	30	0.35	19000	310	300	0.14	890	X027a	 SOT-227B miniBLOC	
IXFN 32N120P	32	0.31	21000	360	300	0.125	1000	X027a		

PolarP2™ Power MOSFETs



Part Type	V _{DSS}	I _{D(cont)} Chip T _C = 25°C	R _{DS(on)} T _J = 25°C	C _{iss}	Q _g	t _{rr}	R _{thJC}	P _D	Fig. No.	Package style					
➤ New	V	A	Ω	typ. pF	typ. nC	typ. ns	K/W	W		Outline drawings on pages O-31...O-52					
PolarP2™ Standard Power MOSFETs										X005a	TO-220AB				
IXTH 450P2	500	16	0.33	2530	43	400	0.42	300	X014a	X011b	TO-263AB				
IXTP 450P2		16	0.33	2530	43	400	0.42	300	X005a						
IXTQ 450P2		16	0.33	2530	43	400	0.42	300	X017a						
IXTA 460P2		24	0.27	2890	48	400	0.26	480	X011b						
IXTH 460P2		24	0.27	2890	48	400	0.26	480	X014a						
IXTP 460P2		24	0.27	2890	48	400	0.26	480	X005a						
IXTQ 460P2		24	0.27	2890	48	400	0.26	480	X017a						
IXTQ 470P2		42	0.145	5400	88	400	0.15	830	X017a						
IXTQ 480P2		52	0.12	6800	108	400	0.13	960	X017a	X014a	TO-247AD				
PolarP2™ HiPerFETs with Fast Intrinsic Diode										X015a	PLUS247				
IXFQ 24N50P2	500	24	0.27	2890	48	200	0.26	480	X017a	X017a	TO-3P				
IXFH 42N50P2		42	0.145	5300	92	250	0.15	830	X014a						
IXFT 42N50P2		42	0.145	5300	92	250	0.15	830	X019						
IXFH 52N50P2		52	0.12	6800	113	250	0.13	960	X014a						
IXFT 52N50P2		52	0.12	6800	113	250	0.13	960	X019						
➤ IXFN 94N50P2		68	0.055	13700	220	250	0.16	780	X027a						
IXFK 74N50P2		74	0.077	9900	165	250	0.089	1400	X020a						
IXFX 74N50P2		74	0.077	9900	165	250	0.089	1400	X015a						
IXFK 94N50P2		94	0.055	14200	228	250	0.096	1300	X020a						
IXFX 94N50P2		94	0.055	14200	228	250	0.096	1300	X015a						
IXFB 120N50P2		120	0.043	19000	300	300	0.066	1890	X021a						
													X019	TO-268AA	
													X020a	TO-264	

PolarP3™ HiPerFETs



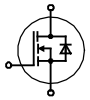



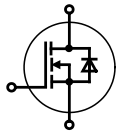

Part Type	V _{DSS}	I _{D(cont)} Chip T _C = 25°C	R _{DS(on)} T _J = 25°C	C _{iss}	Q _g	t _{rr}	R _{thJC}	P _D	Fig. No.	Package style		
➤ New	V	A	Ω	typ. pF	typ. nC	max. (typ.) ns	K/W	W				
➤ IXFP 36N30P3	300	36	0.11	2040	30	(125)	0.36	347	X005a	X021a	PLUS264	
➤ IXFA 36N30P3		36	0.11	2040	30	(125)	0.36	347	X011b			
IXFH 94N30P3		94	0.036	5510	102	250	0.12	1040	X014a	X022e	ISOPLUS264™	
IXFQ 94N30P3		94	0.036	5510	102	250	0.12	1040	X017a			
IXFT 94N30P3		94	0.036	5510	102	250	0.12	1040	X019			
IXFL 210N30P3		108	0.016	16200	268	250	0.24	520	X022e	X027a	SOT-227B miniBLOC	
IXFK 120N30P3		120	0.027	8630	150	250	0.11	1130	X020a			
IXFX 120N30P3		120	0.027	8630	150	250	0.11	1130	X015a			
IXFK 150N30P3		150	0.019	12100	197	250	0.096	1300	X020a			
IXFX 150N30P3		150	0.019	12100	197	250	0.096	1300	X015a			
IXFN 210N30P3		192	0.0145	16200	268	250	0.083	1500	X027a			
IXFB 210N30P3		210	0.0145	16200	268	250	0.066	1890	X021a			

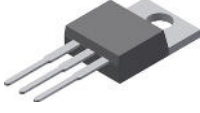

Part Type	V _{DSS} V	I _{D(cont)} Chip T _C = 25°C A	R _{DS(on)} T _J = 25°C Ω	C _{iss} typ. pF	Q _g typ. nC	t _{rr} typ. ns	R _{thJC} K/W	P _D W	Fig. No.	Package style Outline drawings on pages O-31...O-52
IXFJ 26N50P3	500	14	0.265	2220	42	250	0.69	180	X016c	X005a TO-220AB
IXFA 16N50P3		16	0.36	1515	29	250	0.38	330	X011b	
IXFH 16N50P3		16	0.36	1515	29	250	0.38	330	X014a	
IXFP 16N50P3		16	0.36	1515	29	250	0.38	330	X005a	
IXFA 20N50P3		20	0.3	1800	36	250	0.36	380	X011b	
IXFH 20N50P3		20	0.3	1800	36	250	0.36	380	X014a	
IXFP 20N50P3		20	0.3	1800	36	250	0.36	380	X005a	
IXFQ 20N50P3		20	0.3	1800	36	250	0.36	380	X017a	
IXFA 26N50P3		26	0.23	2220	42	250	0.25	500	X011b	
IXFH 26N50P3		26	0.23	2220	42	250	0.25	500	X014a	
IXFP 26N50P3		26	0.23	2220	42	250	0.25	500	X005a	
IXFQ 26N50P3		26	0.23	2220	42	250	0.25	500	X017a	
IXFH 34N50P3		34	0.17	3260	60	250	0.18	695	X014a	
IXFQ 34N50P3		34	0.17	3260	60	250	0.18	695	X017a	
IXFH 50N50P3		50	0.12	4335	85	250	0.13	960	X014a	
IXFQ 50N50P3		50	0.12	4335	85	250	0.13	960	X017a	
IXFT 50N50P3		50	0.12	4335	85	250	0.13	960	X019	
IXFH 60N50P3		60	0.1	6250	96	250	0.12	1040	X014a	
IXFQ 60N50P3		60	0.1	6250	96	250	0.12	1040	X017a	
IXFT 60N50P3		60	0.1	6250	96	250	0.12	1040	X019	
IXFL 132N50P3		63	0.043	18600	250	250	0.24	520	X022e	
IXFK 78N50P3		78	0.068	9900	147	250	0.11	1130	X020a	
IXFX 78N50P3		78	0.068	9900	147	250	0.11	1130	X015a	
IXFK 98N50P3		98	0.05	13100	197	250	0.096	1300	X020a	
IXFX 98N50P3		98	0.05	13100	197	250	0.096	1300	X015a	
IXFN 132N50P3		112	0.039	18600	250	250	0.083	1500	X027a	
IXFB 132N50P3		132	0.039	18600	250	250	0.066	1890	X021a	
IXFA 14N60P3	600	14	0.54	1480	25	250	0.38	327	X011b	
IXFH 14N60P3		14	0.54	1480	25	250	0.38	327	X014a	
IXFP 14N60P3		14	0.54	1480	25	250	0.38	327	X005a	
IXFA 16N60P3		16	0.44	1830	36	250	0.36	347	X011b	
IXFH 16N60P3		16	0.44	1830	36	250	0.36	347	X014a	
IXFP 16N60P3		16	0.44	1830	36	250	0.36	347	X005a	
IXFA 22N60P3		22	0.36	2600	38	250	0.25	500	X011b	
IXFH 22N60P3		22	0.36	2600	38	250	0.25	500	X014a	
IXFP 22N60P3		22	0.36	2600	38	250	0.25	500	X005a	
IXFQ 22N60P3		22	0.36	2600	38	250	0.25	500	X017a	
IXFH 28N60P3		28	0.26	3560	50	250	0.18	695	X014a	
IXFQ 28N60P3		28	0.26	3560	50	250	0.18	695	X017a	
IXFH 42N60P3		42	0.185	5150	78	250	0.15	830	X014a	
IXFR 80N60P3		48	0.076	13100	190	250	0.23	540	X016a	
IXFH 50N60P3		50	0.145	6300	94	250	0.12	1040	X014a	
IXFQ 50N60P3		50	0.145	6300	94	250	0.12	1040	X017a	
IXFT 50N60P3		50	0.145	6300	94	250	0.12	1040	X019	
IXFK 64N60P3		64	0.095	9900	145	250	0.11	1130	X020a	
IXFX 64N60P3		64	0.095	9900	145	250	0.11	1130	X015a	
IXFN 80N60P3		66	0.077	13100	190	250	0.13	960	X027a	
IXFK 80N60P3		80	0.07	13100	190	250	0.096	1300	X020a	
IXFX 80N60P3		80	0.07	13100	190	250	0.096	1300	X015a	
IXFN 110N60P3		90	0.056	18000	245	250	0.083	1500	X027a	
IXFB 110N60P3		110	0.056	18000	245	250	0.066	1890	X021a	

X-Class Power MOSFETs









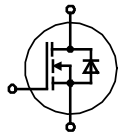

Part Type	V _{DSS}	I _{D(cont)} Chip T _C = 25°C	R _{DS(on)} T _J = 25°C	C _{iss} typ.	Q _g typ.	t _{rr} typ.	R _{thJC}	P _D	Fig. No.	Package style	
➤ New	V	A	Ω	pF	nC	ns	K/W	W		Outline drawings on pages O-31...O-52	
X-Class Standard Types										X004	TO-252AA
➤ IXTP 20N65XM	650	9	0.210	1390	35	350	2.00	63	X007a		
➤ IXTP 32N65XM		14	0.135	2206	54	400	1.60	78	X007a		
➤ IXTP 20N65X		20	0.210	1390	35	350	0.39	320	X005a		
➤ IXTA 20N65X		20	0.210	1390	35	350	0.39	320	X011b		
➤ IXTH 20N65X		20	0.210	1390	35	350	0.39	320	X014a		
➤ IXTQ 32N65X		32	0.135	2205	54	400	0.25	500	X017a		
➤ IXTH 32N65X		32	0.135	2205	54	400	0.25	500	X014a		
➤ IXTP 32N65X		32	0.135	2206	54	400	0.25	500	X005a		
X-Class Power MOSFETs with Fast Body Diode										X007a	TO-220FPAB
➤ IXFA 18N60X	600	18	0.23	1440	35	127	0.39	320	X011b		
➤ IXFH 18N60X		18	0.23	1440	35	127	0.39	320	X014a		
➤ IXFP 18N60X		18	0.23	1440	35	127	0.39	320	X005a		
➤ IXFA 24N60X		24	0.175	1910	47	140	0.31	400	X011b		
➤ IXFH 24N60X		24	0.175	1910	47	140	0.31	400	X014a		
➤ IXFP 24N60X		24	0.175	1910	47	140	0.31	400	X005a		
➤ IXFQ 24N60X		24	0.175	1910	47	140	0.31	400	X017a		
➤ IXFH 30N60X		30	0.155	2270	56	145	0.25	500	X014a		
➤ IXFT 30N60X		30	0.155	2270	56	145	0.25	500	X019		
➤ IXFQ 30N60X		30	0.155	2270	56	145	0.25	500	X017a		
➤ IXFH 50N60X		50	0.073	4660	116	195	0.19	660	X014a		
➤ IXFT 50N60X		50	0.073	4660	116	195	0.19	660	X019		
➤ IXFQ 50N60X		50	0.073	4660	116	195	0.19	660	X017a		
➤ IXFK 90N60X		90	0.038	8500	210	210	0.113	1100	X020a		
➤ IXFX 90N60X		90	0.038	8500	210	210	0.113	1100	X015a		
X2-Class Power MOSFETs										X017a	TO-3P
➤ IXTY 2N65X2	650	2	2.3	176	4.3	137	2.27	55	X004		
➤ IXTP 2N65X2		2	2.3	176	4.3	137	2.27	55	X005a		
➤ IXTA 4N65X2		4	0.85	455	8.3	160	1.56	80	X011b		
➤ IXTY 4N65X2		4	0.85	455	8.3	160	1.56	80	X004		
➤ IXTP 4N65X2		4	0.85	455	8.3	160	1.56	80	X005a		
➤ IXTA 8N65X2		8	0.5	800	12	200	0.83	150	X011b		
➤ IXTP 8N65X2		8	0.5	800	12	200	0.83	150	X005a		
➤ IXTY 8N65X2		8	0.5	800	12	200	0.83	150	X004		
➤ IXTX 102N65X2		102	0.03	11000	152	450	0.12	1040	X015a		
➤ IXTK 102N65X2		102	0.03	11000	152	450	0.12	1040	X020a		

SiC Power MOSFETs

Part Type	V _{DSS}	I _{D25} T _C = 25°C	R _{DS(on)} T _C = 25°C	C _{iss} typ.	Q _g typ.	R _{thJC}	t _{rr} Diode typ ns	V _{SD} Diode typ V	Fig. No.	Package style
➤ New	V	A	mΩ	pF	nC	K/W				
➤ IXFN 50N120SiC	1200	47	50	1900	100	0.55	40	3.3	X027a	
➤ MCB 60I1200TZ	1200	90	34	2790	160	0.27	45	3.3	X019	



Q3-Class HiPerFET™ Power MOSFETs

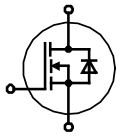

Part Type	V _{DSS}	I _{D(cont)} Chip T _C = 25°C	R _{DS(on)} T _J = 25°C	C _{iss} typ.	Q _g typ.	t _{rr} max. (typ.) ns	R _{thJC}	P _D	Fig. No.	Package style Outline drawings on pages O-31...O-52			
➤ New	V	A	Ω	pF	nC		K/W	W					
IXFH 70N20Q3 IXFT 70N20Q3	200	70	0.04	3150	67	250	0.18	690	X014a X019	X014a TO-247AD 			
IXFH 50N30Q3 IXFT 50N30Q3 IXFT 70N30Q3 IXFH 70N30Q3	300	50 50 70 70	0.08 0.08 0.054 0.054	3160 3160 4735 4735	65 65 98 98	250 250 250 250	0.18 0.18 0.15 0.15	690 690 830 830	X014a X019 X019 X014a				
IXFR 44N50Q3 IXFT 30N50Q3 IXFH 30N50Q3 IXFH 44N50Q3 IXFT 44N50Q3	500	25 30 30 44 44	0.154 0.20 0.20 0.14 0.14	4800 3200 3200 4800 4800	93 62 62 93 93	250 250 250 250 250	0.41 0.18 0.18 0.15 0.15	300 690 690 830 830	X016a X019 X014a X014a X019		X015a PLUS247 		
IXFR 64N50Q3 IXFR 80N50Q3		45 50	0.094 0.072	6950 10000	145 200	250 250	0.25 0.22	500 570	X016a X016a				
IXFN 80N50Q3 IXFK 64N50Q3 IXFX 64N50Q3 IXFX 80N50Q3 IXFK 80N50Q3 IXFN 100N50Q3 IXFB 100N50Q3		63 64 64 80 80 82 100	0.065 0.085 0.085 0.065 0.065 0.049 0.049	10000 6950 6950 10000 10000 13800 13800	200 145 145 200 200 255 255	250 250 250 250 250 250 250	0.16 0.125 0.125 0.10 0.10 0.13 0.08	780 1000 1000 1250 1250 960 1560	X027a X020a X015a X015a X020a X027a X021a			X016a ISOPLUS247™ 	
IXFR 48N60Q3 IXFR 64N60Q3	600	32 42	0.154 0.104	7020 9930	140 190	300 300	0.25 0.22	500 568	X016a X016a				
IXFK 48N60Q3 IXFX 48N60Q3 IXFK 64N60Q3 IXFX 64N60Q3 IXFN 82N60Q3 IXFB 82N60Q3		48 48 64 64 66 82	0.14 0.14 0.095 0.095 0.075 0.075	7020 7020 9930 9930 13500 13500	140 140 190 190 275 275	300 300 300 300 300 300	0.125 0.125 0.10 0.10 0.13 0.08	1000 1000 1250 1250 960 1560	X020a X015a X020a X015a X027a X021a	X019 TO-268AA 			
IXFR 32N80Q3 IXFK 32N80Q3 IXFX 32N80Q3 IXFN 44N80Q3 IXFX 44N80Q3 IXFK 44N80Q3 IXFN 62N80Q3 IXFB 62N80Q3	800	24 32 32 37 44 44 49 62	0.30 0.27 0.27 0.19 0.19 0.19 0.14 0.14	6940 6940 6940 10950 10950 10950 13600 13600	140 140 140 185 185 185 270 270	300 300 300 300 300 300 300 300	0.25 0.125 0.125 0.16 0.10 0.10 0.13 0.08	500 1000 1000 780 1250 1250 960 1560	X016a X020a X015a X027a X015a X020a X027a X021a		X019a TO-268AAHV 		
IXFR 15N100Q3 IXFT 15N100Q3 IXFH 15N100Q3 IXFH 18N100Q3 IXFT 18N100Q3	1000	10 15 15 18 18	1.20 1.05 1.05 0.66 0.66	3250 3250 3250 4890 4890	64 64 64 90 90	250 250 250 300 300	0.31 0.18 0.18 0.15 0.15	400 690 690 830 830	X027a X019 X014a X014a X019				X020a TO-264 
IXFR 24N100Q3 IXFR 32N100Q3 IXFK 24N100Q3 IXFX 24N100Q3 IXFN 32N100Q3 IXFK 32N100Q3 IXFX 32N100Q3 IXFN 44N100Q3 IXFB 44N100Q3		18 23 24 24 28 32 32 38 44	0.49 0.35 0.44 0.44 0.32 0.32 0.32 0.22 0.22	7200 10900 7200 7200 10900 10900 10900 13600 13600	140 195 140 140 195 195 195 264 264	300 300 300 300 300 250 250 300 300	0.25 0.22 0.125 0.125 0.16 0.10 0.10 0.13 0.08	500 570 1000 1000 780 1250 1250 960 1560	X027a X027a X020a X015a X027a X020a X015a X027a X021a			X021a PLUS264 	
IXFN 40N110Q3 IXFB 40N110Q3	1100	35 40	0.26 0.26	14000 14000	300 300	(434) (434)	0.13 0.08	960 1560	X027a X021a				

Very High Voltage Power MOSFETs (2 - 4.5 kV)







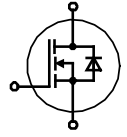

Part Type	V _{DSS}	I _{D(cont)} Chip T _C = 25°C	R _{DS(on)} T _J = 25°C	C _{iss} typ.	Q _g typ.	t _{rr} typ.	R _{thJC}	P _D	Fig. No.	Package style Outline drawings on pages O-31...O-52	
➤ New	V	A	Ω	pF	nC	ns	K/W	W			
➤ IXTH 1N200P3	2000	1.0	40	646	23.5	2300	1.0	125	X014a	X003 TO-251AA	
➤ IXTH 1N200P3HV		1.0	40	646	23.5	2300	1.0	125	X014c		
➤ IXTA 1N200P3HV		1.0	40	646	23.5	2300	1.0	125	X011c		
➤ IXTH 06N220P3HV	2200	0.6	80	290	10.4	1100	1.2	104	X014c		
➤ IXTH 1R8N220P3HV		1.8	21.5	965	31	1300	0.64	194	X014c		
IXTA 02N250HV	2500	0.2	450	116	7.4	1500	1.5	83	X011c	X004 TO-252AA	
IXTH 02N250		0.2	450	116	7.4	1500	1.5	83	X014a		
IXTH 05N250P3HV		0.5	110	303	10.5	1200	1.2	104	X014c		
IXTF 1N250		1.0	40	1660	41	2500	1.13	110	X024c		
IXTH 1R4N250P3		1.4	28	960	33	1800	0.64	195	X014a		
IXTH 1N250		1.5	40	1660	41	2500	0.5	250	X014a		
IXTT 1N250HV		1.5	40	1660	41	2500	0.5	250	X019a		
IXTN 5N250		5.0	8.8	8560	200	1200	0.18	700	X027a		
IXTK 5N250		5.0	8.8	8560	200	1200	0.13	960	X020a		
IXTX 5N250		5.0	8.8	8560	200	1200	0.13	960	X015a		
➤ IXTH 04N300P3HV	3000	0.4	190	283	13	1100	1.2	104	X014c		X005a TO-220AB
➤ IXTT 1N300P3HV		1.0	50	895	30.6	1800	0.64	195	X019a		
➤ IXTH 1N300P3HV		1.0	50	895	30.6	1800	0.64	195	X014c		
IXTH 02N450HV	4500	0.2	625	246	10.6	1600	1.1	113	X014c	X011c TO-263ABHV	
IXTF 02N450		0.2	625	246	10.6	1600	1.6	78	X024c		
IXTT 02N450HV		0.2	625	246	10.6	1600	1.1	113	X019a		
IXTF 1N450		0.9	80	1700	46	1750	0.77	165	X024c		
IXTT 1N450HV		1.0	80	1700	46	1750	0.24	520	X019a		
➤ IXTH 1N450HV		1.0	80	1700	46	1750	0.24	520	X014c		
IXTL 2N450		2.0	20	6860	180	1750	0.56	220	X022e		

Legacy (Standard) Power MOSFETs

Part Type	V _{DSS}	I _{D(cont)} Chip T _C = 25°C	R _{DS(on)} T _J = 25°C	C _{iss} typ.	Q _g typ.	t _{rr} typ.	R _{thJC}	P _D	Fig. No.	Package style
➤ New	V	A	Ω	pF	nC	ns	K/W	W		
IXTU 01N100	1000	0.1	80	60	8.0	1500	3.0	25	X003	X015a PLUS247
IXTY 01N100		0.1	80	60	8.0	1500	3.0	25	X004	
IXTP 05N100		0.75	17	260	7.8	710	3.1	40	X005a	
IXTU 05N100		0.75	17	260	7.8	710	3.1	40	X003	
IXTY 05N100		0.75	17	260	7.8	710	3.1	40	X004	
IXTA 05N100		0.75	17	260	7.8	710	3.1	40	X011b	
➤ IXTA 05N100HV		0.75	17	260	7.8	710	3.1	40	X011c	
IXTP 1N100		1.5	11	480	23.0	710	2.3	54	X005a	
IXTA 1N100		1.5	11	480	23.0	710	2.3	54	X011b	
IXTP 2N100		2.0	7.0	825	18.0	800	1.25	100	X005a	
IXTA 2N100	2.0	7.0	825	18.0	800	1.25	100	X011b		
IXTX 24N100		24.0	0.4	8700	267	850	0.22	568	X015a	
IXTP 3N120	1200	3.0	4.5	1050	39.0	700	0.62	200	X005a	X022e ISOPLUS264/i5-Pak
IXTH 3N120		3.0	4.5	1050	39.0	700	0.80	100	X014a	
IXTA 3N120		3.0	4.5	1050	39.0	700	0.62	200	X011b	
➤ IXTA 3N120HV		3.0	4.5	1050	39.0	700	0.62	200	X011c	
IXTH 6N120		6.0	2.4	1950	56.0	850	0.42	300	X014a	X019
IXTT 6N120		6.0	2.4	1950	56.0	850	0.42	300	X019	
➤ IXTA 3N150HV	1500	3.0	7.3	1375	38.6	900	0.50	110	X011c	X024c ISOPLUS i4-PAC™
IXTH 3N150		3.0	7.3	1375	38.6	900	0.50	250	X014a	
➤ IXTJ 3N150		2.5	8.0	1375	38.6	900	1.13	250	X016c	
➤ IXTA 4N150HV		4.0	6.0	1576	44.5	900	0.45	280	X011c	
IXTH 4N150		4.0	6.0	1576	44.5	900	0.45	280	X014a	
➤ IXTJ 4N150		2.5	6.0	1576	44.5	900	1.13	110	X016c	
➤ IXTT 4N150HV		4.0	6.0	1576	44.5	900	0.45	280	X019a	
IXTH 6N150		6.0	3.5	2230	67.0	1500	0.23	540	X014a	
➤ IXTJ 6N150		3.0	3.85	2230	67.0	1500	1.0	125	X016c	
IXTT 6N150		6.0	3.5	2230	67.0	1500	0.23	540	X014a	
➤ IXTT 12N150HV		12.0	2.0	3720	106	1200	0.14	890	X019a	

LinearL2™ Power MOSFETs with Extended FBSOAs



Part Type	V _{DSS}	I _{D(cont)} Chip T _C = 25°C	R _{DS(on)} T _J = 25°C	C _{iss} typ.	Q _g typ.	t _{rr} typ.	R _{thJC}	P _D	Fig. No.	Package style	
➤ New	V	A	Ω	pF	nC	ns	K/W	W		Outline drawings on pages O-31...O-52	
➤ IXTP 80N075L2	75	80	0.024	3600	103	160	0.35	357	X005a	X005a	TO-220AB 
➤ IXTA 80N075L2		80	0.024	3600	103	160	0.35	357	X011b		
➤ IXTH 80N075L2		80	0.024	3600	103	160	0.35	357	X014a		
➤ IXTA 64N10L2	100	64	0.032	3620	100	180	0.35	357	X011b	X011b	TO-263AB 
➤ IXTH 64N10L2		64	0.032	3620	100	180	0.35	357	X014a		
➤ IXTP 64N10L2		64	0.032	3620	100	180	0.35	357	X005a		
IXTH 75N10L2		75	0.021	8100	215	180	0.31	400	X014a		
IXTT 75N10L2		75	0.021	8100	215	180	0.31	400	X019		
IXTH 110N10L2		110	0.018	10500	260	230	0.21	600	X014a		
IXTT 110N10L2		110	0.018	10500	260	230	0.21	600	X019		
IXTN 200N10L2		178	0.011	23000	540	245	0.15	830	X027a		
IXTX 200N10L2		200	0.011	23000	540	245	0.12	1040	X015a		
IXTK 200N10L2		200	0.011	23000	540	245	0.12	1040	X020a		
IXTH 60N20L2		200	60	0.045	10500	255	330	0.23	540		
IXTT 60N20L2	60		0.045	10500	255	330	0.23	540	X019		
IXTQ 60N20L2	60		0.045	10500	255	330	0.23	540	X017a		
IXTN 110N20L2	100		0.024	23000	500	420	0.17	735	X027a		
IXTX 110N20L2	110		0.024	23000	500	420	0.13	960	X015a		
IXTK 110N20L2	110		0.024	23000	500	420	0.13	960	X020a		
IXTX 90N25L2	250	90	0.033	23000	640	266	0.13	960	X015a	X014a	TO-247AD 
IXTN 90N25L2		90	0.033	23000	640	266	0.17	735	X027a		
IXTK 90N25L2		90	0.033	23000	640	266	0.13	960	X020a		
IXTA 15N50L2	500	15	0.48	4080	123	570	0.42	300	X011b	X015a	PLUS247 
IXTP 15N50L2		15	0.48	4080	123	570	0.42	300	X005a		
IXTH 15N50L2		15	0.48	4080	123	570	0.42	300	X014a		
IXTH 30N50L2		30	0.2	8100	240	500	0.31	400	X014a		
IXTT 30N50L2		30	0.2	8100	240	500	0.31	400	X019		
IXTQ 30N50L2		30	0.2	8100	240	500	0.31	400	X017a		
IXTH 40N50L2		40	0.17	10400	320	500	0.23	540	X014a		
IXTT 40N50L2		40	0.17	10400	320	500	0.23	540	X019		
IXTQ 40N50L2		40	0.17	10400	320	500	0.23	540	X017a		
IXTN 60N50L2		53	0.1	24000	610	980	0.17	735	X027a		
IXTX 60N50L2		60	0.1	24000	610	980	0.13	960	X015a		
IXTK 60N50L2	60	0.1	24000	610	980	0.13	960	X020a			
IXTH 30N60L2	600	30	0.24	10700	335	710	0.23	540	X014a	X019	TO-268AA 
IXTT 30N60L2		30	0.24	10700	335	710	0.23	540			
IXTQ 30N60L2		30	0.24	10700	335	710	0.23	540			

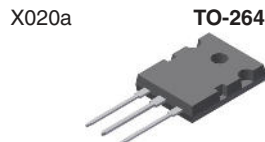



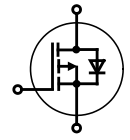





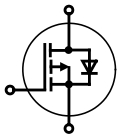

PolarP™ P-Channel Power MOSFETs



Part Type	V _{DSS} V	I _{D(cont)} Chip T _C = 25°C A	R _{DS(on)} T _J = 25°C Ω	C _{iss} typ. pF	Q _g typ. nC	t _{rr} typ. ns	R _{thJC} K/W	P _D W	Fig. No.	Package style Outline drawings on pages O-31...O-52
IXTX 32P60P	-600	-32	0.35	11100	196	480	0.14	890	X015a	X005a TO-220AB 
IXTN 32P60P	-600	-32	0.35	11100	196	480	0.14	890	X027a	
IXTK 32P60P	-600	-32	0.35	11100	196	480	0.14	890	X020a	
IXTR 32P60P	-600	-18	0.385	11100	196	480	0.4	310	X016a	
IXTH 16P60P	-600	-16	0.72	5120	92	440	0.27	460	X005a	X011b TO-263AB 
IXTT 16P60P	-600	-16	0.72	5120	92	440	0.27	460	X019	
IXTR 16P60P	-600	-10	0.79	5120	92	440	0.66	190	X016a	
IXTX 40P50P	-500	-40	0.23	11.5	205	477	0.14	890	X015a	X014a TO-247AD 
IXTN 40P50P	-500	-40	0.23	11500	205	477	0.14	890	X027a	
IXTK 40P50P	-500	-40	0.23	11500	205	477	0.14	890	X020a	
IXTR 40P50P	-500	-22	0.26	11500	205	477	0.4	312	X016a	
IXTH 20P50P	-500	-20	0.45	5120	103	406	0.27	460	X014a	X015a PLUS247 
IXTT 20P50P	-500	-20	0.45	5120	103	406	0.27	460	X019	
IXTR 20P50P	-500	-13	0.49	5120	103	406	0.66	190	X016a	
IXTP 10P50P	-500	-10	1	2670	50	414	0.5	300	X005a	X017a ISOPLUS247™ 
IXTH 10P50P	-500	-10	1	2670	50	414	0.5	300	X005a	
IXTA 10P50P	-500	-10	1	2670	50	414	0.5	300	X011b	
IXTQ 10P50P	-500	-10	1	2670	50	414	0.5	300	X017a	
IXTX 90P20P	-200	-90	0.044	12000	205	315	0.14	890	X015a	X016a ISOPLUS247™ 
IXTN 90P20P	-200	-90	0.044	12000	205	315	0.14	890	X027a	
IXTK 90P20P	-200	-90	0.044	12000	205	315	0.14	890	X020a	
IXTR 90P20P	-200	-53	0.048	12000	205	315	0.4	312	X016a	
IXTH 48P20P	-200	-48	0.085	5400	103	260	0.27	462	X014a	X017a TO-3P 
IXTT 48P20P	-200	-48	0.085	5400	103	260	0.27	462	X019	
IXTR 48P20P	-200	-30	0.093	5400	103	260	0.66	190	X016a	
IXTP 26P20P	-200	-26	0.17	2740	56	240	0.42	300	X005a	X019 TO-268AA 
IXTH 26P20P	-200	-26	0.17	2740	56	240	0.42	300	X014a	
IXTA 26P20P	-200	-26	0.17	2740	56	240	0.42	300	X011b	
IXTQ 26P20P	-200	-26	0.17	2740	56	240	0.42	300	X017a	
IXTR 36P15P	-150	-36	0.11	3100	55	228	0.42	300	X005a	
IXTH 36P15P	-150	-36	0.11	3100	55	228	0.42	300	X014a	X020a TO-264 
IXTA 36P15P	-150	-36	0.11	3100	55	228	0.42	300	X011b	
IXTQ 36P15P	-150	-36	0.11	3100	55	228	0.42	300	X017a	
IXTR 36P15P	-150	-22	0.12	2950	55	150	1	150	X016a	
IXTX 170P10P	-100	-170	0.012	12600	240	176	0.14	890	X015a	X027a SOT-227B miniBLOC 
IXTN 170P10P	-100	-170	0.012	12600	240	176	0.14	890	X027a	
IXTK 170P10P	-100	-170	0.012	12600	240	176	0.14	890	X020a	
IXTR 170P10P	-100	-108	0.013	12600	240	176	0.4	312	X016a	
IXTH 90P10P	-100	-90	0.025	5800	120	144	0.27	462	X014a	X017a SOT-227B miniBLOC 
IXTT 90P10P	-100	-90	0.025	5800	120	144	0.27	462	X019	
IXTR 90P10P	-100	-57	0.027	5800	120	144	0.66	190	X016a	
IXTP 52P10P	-100	-52	0.05	2845	60	120	0.42	300	X005a	X017a SOT-227B miniBLOC 
IXTH 52P10P	-100	-52	0.05	2845	60	120	0.42	300	X014a	
IXTA 52P10P	-100	-52	0.05	2845	60	120	0.42	300	X011b	
IXTQ 52P10P	-100	-52	0.05	2845	60	120	0.42	300	X017a	

TrenchP™ P-Channel MOSFETs



Part Type	V _{DSS}	I _{D(cont)} Chip T _C = 25°C	R _{DS(on)} T _J = 25°C	C _{iss} typ.	Q _g typ.	t _{rr} typ. (max)	R _{thJC}	P _D	Fig. No.	Package style Outline drawings on pages O-31...O-52	
➤ New	V	A	Ω	pF	nC	ns	K/W	W			
IXTK 120P20T	-200	-120	0.03	73000	740	(300)	0.12	1040	X020a	X004	TO-252AA 
IXTX 120P20T		-120	0.03	73000	740	(301)	0.12	1040	X015a		
IXTN 120P20T		-106	0.03	73000	740	(302)	0.15	830	X027a		
IXTR 120P20T		-90	0.032	73000	740	(303)	0.21	595	X016a		
IXTH 68P20T		-68	0.055	33400	380	245	0.22	568	X014a	X005a	TO-220AB 
IXTT 68P20T		-68	0.055	33400	380	245	0.22	568	X019		
IXTR 68P20T		-44	0.064	33400	380	245	0.46	270	X016a		
IXTA 32P20T		-32	0.13	14500	185	190	0.42	300	X011b	X011b	TO-263AB 
IXTP 32P20T		-32	0.13	14500	185	190	0.42	300	X005a		
IXTH 32P20T		-32	0.13	14500	185	190	0.42	300	X014a		
IXTQ 32P20T		-32	0.13	14500	185	190	0.42	300	X017a		
IXTP 44P15T	-150	-44	0.065	13400	175	140	0.42	298	X005a	X014a	TO-247AD 
IXTH 44P15T		-44	0.065	13400	175	140	0.42	298	X014a		
IXTA 44P15T		-44	0.065	13400	175	140	0.42	298	X011b		
IXTQ 44P15T		-44	0.065	13400	175	140	0.42	298	X017a		
IXTP 15P15T		-15	0.24	3650	48	116	0.83	150	X005a		
IXTY 15P15T		-15	0.24	3650	48	116	0.83	150	X004		
IXTA 15P15T		-15	0.24	3650	48	116	0.83	150	X011b		
IXTP 10P15T		-10	0.35	2210	36	120	1.50	83	X005a		
IXTY 10P15T		-10	0.35	2210	36	120	1.50	83	X004		
IXTA 10P15T		-10	0.35	2210	36	120	1.50	83	X011b		
IXTK 210P10T	-100	-210	0.0075	69500	740	(200)	0.12	1040	X020a	X015a	PLUS247 
IXTN 210P10T		-210	0.0075	69500	740	(201)	0.15	830	X027a		
IXTX 210P10T		-210	0.0075	69500	740	(202)	0.12	1040	X015a		
IXTR 210P10T		-195	0.008	69500	740	(203)	0.32	390	X016a		
IXTH 140P10T		-140	0.012	31400	400	130	0.22	568	X014a	X016a	ISOPLUS247™ 
IXTT 140P10T		-140	0.012	31400	400	130	0.22	568	X019		
IXTR 140P10T		-90	0.013	31400	400	130	0.46	270	X016a		
IXTP 76P10T		-76	0.025	13700	197	70	0.42	298	X005a	X017a	TO-3P 
IXTH 76P10T		-76	0.025	13700	197	70	0.42	298	X014a		
IXTA 76P10T		-76	0.025	13700	197	70	0.42	298	X011b		
IXTP 26P10T		-26	0.09	3820	52	70	0.83	150	X005a		
IXTY 26P10T		-26	0.09	3820	52	70	0.83	150	X004		
IXTA 26P10T		-26	0.09	3820	52	70	0.83	150	X011b		
IXTP 18P10T		-18	0.12	2100	39	62	1.50	83	X005a		
IXTY 18P10T		-18	0.12	2100	39	62	1.50	83	X004		
IXTA 18P10T		-18	0.12	2100	39	62	1.50	83	X011b		
IXTP 96P085T		-85	-96	0.013	13100	180	55	0.42	298		
IXTH 96P085T	-96		0.013	13100	180	55	0.42	298	X014a		
IXTA 96P085T	-96		0.013	13100	180	55	0.42	298	X011b		
IXTP 24P085T	-24		0.065	2090	41	40	1.50	83	X005a		
IXTA 24P085T	-24		0.065	2090	41	40	1.50	83	X011b		
IXTP 120P065T	-65	-120	0.01	13200	185	53	0.42	298	X005a	X020a	TO-264 
IXTH 120P065T		-120	0.01	13200	185	53	0.42	298	X014a		
IXTA 120P065T		-120	0.01	13200	185	53	0.42	298	X011b		
IXTP 28P065T		-28	0.045	2030	46	31	1.50	83	X005a		
IXTA 28P065T		-28	0.045	2030	46	31	1.50	83	X011b		
IXTP 140P05T	-50	-140	0.009	13500	200	53	0.42	298	X005a	X027a	SOT-227B miniBLOC 
IXTH 140P05T		-140	0.009	13500	200	53	0.42	298	X014a		
IXTA 140P05T		-140	0.009	13500	200	53	0.42	298	X011b		
IXTP 48P05T		-48	0.03	3660	53	30	0.83	150	X005a		
IXTY 48P05T		-48	0.03	3660	53	30	0.83	150	X004		
IXTA 48P05T		-48	0.03	3660	53	30	0.83	150	X011b		
IXTP 32P05T		-32	0.039	1975	46	26	1.50	83	X005a		
IXTY 32P05T		-32	0.039	1975	46	26	1.50	83	X004		
IXTA 32P05T		-32	0.039	1975	46	26	1.50	83	X011b		

CoolMOS™ Power MOSFETs

CoolMOS™ is a trademark of Infineon Technologies

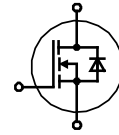

K Series - CoolMOS™

Part Type	V _{DSS}	I _{D25} T _C = 25°C	R _{DS(on)} T _J = 25°C	Q _g typ.	R _{thJC}	V _{ISOL} RMS	Fig. No.	Package style Outline drawings on pages O-31...O-52
○ Not for new design								
➤ New	V	A	Ω	nC	K/W	V		
C3 Series								
IXKC 20N60C	600	14	0.19	80	1.00	2500	X010a	X005a TO-220AB
IXKC 40N60C		24	0.096	160	0.50	2500	X010a	
IXKR 40N60C		38	0.07	250	0.45	2500	X016a	
IXKN 40N60C		40	0.07	250	0.43	2500	X027a	
IXKN 75N60C		75	0.036	500	0.22	2500	X027a	
○ IXKK 85N60C		85	0.036	540	0.18	-	X020a	X009a PLUS220
IXKC 13N80C	800	13	0.29	85	0.96	2500	X010a	X010a ISOPLUS220™
IXKC 25N80C		20	0.15	180	0.90	2500	X010a	
IXKR 25N80C		25	0.15	170	0.50	2500	X016a	
IXKN 45N80C		44	0.074	335	0.33	2500	X027a	
C5 Series								
○ IXKH 20N60C5	600	20	0.2	32	0.60	-	X014a	X010a ISOPLUS220™
IXKC 23N60C5		23	0.1	60	0.85	2500	X010a	
IXKP 24N60C5		24	0.165	40	0.50	-	X005a	
IXKH 30N60C5		30	0.125	53	0.40	-	X014a	
IXKH 35N60C5		35	0.1	60	0.35	-	X014a	
IXKR 47N60C5		47	0.045	150	0.45	2500	X016a	
IXKH 70N60C5		70	0.045	150	0.20	-	X014a	
IXKT 70N60C5		66	0.045	150	0.23	-	X019	X013 PLUS220SMD
CFD Series with fast Body Diode								
➤ MKH 24I650HR	650	25	0.8	170	0.65	3000	X016c	X014a TO-247AD
<p>CoolMOS™ Configurations in i4-PAC™</p> <p>SiC MKE..R..DCG.. IXKF FDM FMD LKK</p>								
Configuration in ISOPLUS264™ Package								
Part Type	V _{DSS}	I _{D25} T _C = 25°C	R _{DS(on) max.} T _J = 25°C	Q _g typ.	R _{thJC}	Config.	Fig. No.	X016a ISOPLUS247™
	V	A	Ω	nC	K/W			
IXKF 40N60SCD1	600	38	0.07	250	0.45	single	X024c	X016c ISO247™
IXKF 40N60SCH1		41	0.07	250	0.45	single	X024c	
MKE 11R600DCGFC ¹⁾	600	15	0.165	40	1.1	boost	X024a	X020a TO-264
FMD 15-06KC5		15	0.165	40	1.1	boost	X024a	
FMD 40-06KC		38	0.07	250	0.45	boost	X024a	
FMD 47-06KC5		47	0.045	150	0.45	boost	X024a	
FDM 47-06KC5	600	47	0.045	150	0.45	buck	X022c	
¹⁾ with SiC Boost Diode								
Configuration in ISOPLUS264™ Package								
LKK 47-06C5	600	2 x 47	0.045	150	0.45	dual	X022c	X027a SOT-227B miniBLOC
<p>X027a SOT-227B miniBLOC X024c ISOPLUS i4-PAC™ X024a ISOPLUS i4-PAC™ X022c ISOPLUS264</p>								



MOSFET Modules

HiPerFET and Polar MOSFET Technology

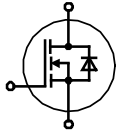
- low R_{DSon}
- fast body diode
- rugged

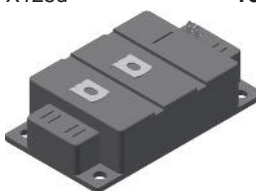

Suffix „F“ = HiPerFET™ Technology with Fast Intrinsic Diode

Part Type	V_{DSS}	I_{D25} $T_C = 25^\circ C$	I_{D80} $T_C = 80^\circ C$	R_{DSon} typ. $T_J = 25^\circ C$	t_r	t_f	R_{thJC}	Fig. No.	Package style Outline drawings on pages O-31...O-52			
○ Not for new design												
➤ New	V	A	A	mΩ	ns	ns	K/W					
Single Switch Modules												
○ VMO 550-01F	100	590	contact factory					X128d	X128d			
○ VMO 650-01F			690	930	1.35	200	500				0.039	X130d
○ VMO 1200-01F			1245									
○ VMO 580-02F	200	580	contact factory					X130d				

Part Type	V_{DSS}	I_{D25} $T_C = 25^\circ C$	R_{DSon} typ. $T_J = 25^\circ C$	t_r	t_f	R_{thJC}	Config	Fig. No.	Package style Outline drawings on pages O-31...O-52
➤ New	V	A	mΩ	ns	ns	K/W			
MOSFET Modules – Phase Leg Configuration									
VMM 90-09F	900	85	65	76	140	0.08	Phase Leg	X130e	

CoolMOS™ MOSFET Technology

* CoolMOS is a trademark of Infineon Technologies

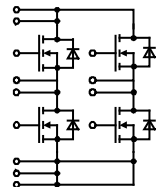

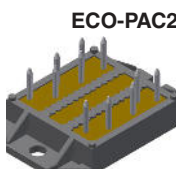

Part Type	V_{DSS}	I_{D25} $T_C = 25^\circ C$	I_{D80} $T_C = 90^\circ C$	R_{DSon} typ. $T_J = 25^\circ C$	t_r	t_f	R_{thJC}	Fig. No.	Package style Outline drawings on pages O-31...O-52
◇ Under development									
➤ New	V	A	A	mΩ	ns	ns	K/W		
MOSFET Modules – H Bridge Configuration									
VKM 40-06P1	600	38		70	10	95	0.45	X102	

Rectifier Bridges for Power Factor Correction

Power Stage for Boost Converters (Power Factor Correction)

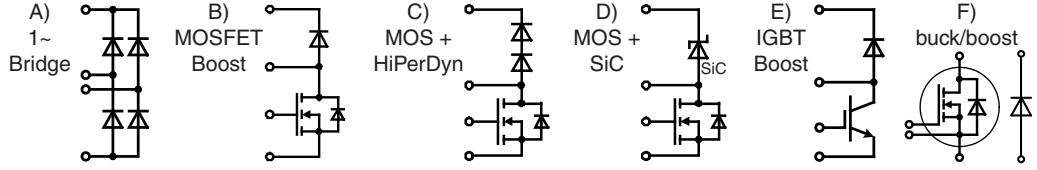
1-phase PFC

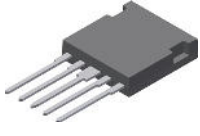

Type	Circuit and Technology	V_{DSS} max	I_D $T_C = 25^\circ\text{C}$	$R_{DS(on)}$ max	V_{RRM} Boost Diode	V_{RRM} Rectifier	Fig. No.	Package style
○ Not for new design ◇ Under development ➤ New		V	A	Ω	V	V		Outline drawings on pages O-31...O-52
MOSFET								
○ FMD 21-05QC	C HiPerFET	500	21	0.220	600	-	X024a	X024a ISOPLUS i4-PAC 
MKE 11R600DCGFC	D CoolMOS™ CP + SiC	600	15	0.165		-	X030a	
FMD 15-06KC5	C CoolMOS™ CP		15	0.165		-		
FMD 40-06KC	C CoolMOS™ C3		38	0.070		-		
FMD 47-06KC5	C CoolMOS™ CP		47	0.045		-		
MKE 38RK600DFELB	B CoolMOS™ CP		50	0.045		-		
◇ MKG 40RK600LB	F CoolMOS™ C6		52	0.037		-		
◇ MKG 17RK600DCGLB	2xD CoolMOS™ C6 + SiC		52	0.037		-		
○ VUM 24-05N	A+B HiPerFET	500	35	0.120	600	800	X105b	X030a SMPD-B 
○ VUM 33-05N			47			1200		
VUM 33-06PH	A+B Polar	600	50			1600		

Type	Circuit and Technology	V_{CES} max	I_C $T_C = 25^\circ\text{C}$	V_{CESat} @ I_C		V_{RRM} Rectifier	Fig. No.
		V	A	V	A	V	
IGBT							
FID 60-06D	E NPT	600	65	1.6	30	-	X024a

Type	Circuit and Technology	V_{RRM} V	I_{DAV} A	@ T_C $^\circ\text{C}$	Fig. No.
Rectifier					
FBO 16-12N *	A Standard	1200	22	90	X024a
FBO 40-12N *			40	90	
DLA 100B800LB **	A low V_F	800	124	135	X030a
DLA 100B1200LB **	A low V_F	1200	124	135	

* Recommended in combination with FMD and FID
** Recommended in combination with MKE and MKG

CoolMOS™ is a trademark of Infineon Technologies

3-phase PFC

“Vienna Rectifier” circuit

- wide input voltage range
- sinusoidal mains input currents in phase with mains
- boost converter operation:
 - input: 3~ AC mains without neutral conductor
 - output: stabilized DC link with center point
- one module used per phase

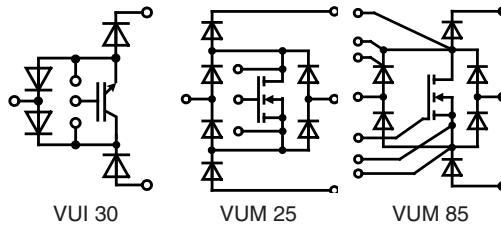

X104 **V2-Pack**

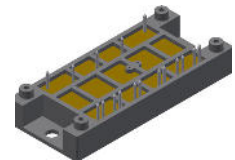

Type	PN / kW 3 ~ 400V. $T_C = 80^\circ\text{C}$	Configuration	Fig. No.
VUM 25-05E ①	10	Vienna rectifier current	X103
VUM 85-05A ①	30	Vienna rectifier current	X104
VUI 30-12N1 ①	15	IGBT stage for buck @ boost PWM converter	X103

X105b **V1-B-Pack**

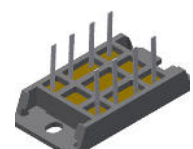

① contact factory

Diodes for High Switching Frequencies

Fast Recovery Epitaxial Diodes (HiPerFRED, FRED) and FRD (SONIC)

Power switches (IGBT, MOSFET, BJT, GTO) for applications in electronics are only as good as their associated free-wheeling diodes. At increasing switching frequencies, the proper functioning and efficiency of the power switch, aside from conduction losses, is determined by the turn-off behavior of the diode (characterized by Q_r , I_{RM} and t_{rr} - Fig. 1). With optimized ultra-fast switching diodes, the development engineer has various possibilities: either higher pulse rate or higher current load or smaller heatsink or more conservative operation due to „cooler“ chips.

The reverse current characteristic following the peak reverse current I_{RM} is another very important property. The slope of the decaying reverse current di_r/dt results from design parameters (technology and diffusion of the diode chips). In a circuit this current slope, in conjunction with parasitic inductances (e.g. connecting leads), causes over-voltage spikes and high frequency in-

terference voltages. The higher the di_r/dt („hard recovery“ or „snap-off“ behavior) the higher is the resulting additional stress for both the diode and the paralleled switch. A slow decay of the reverse current („soft recovery“ behavior), is the most desirable characteristic, and this is designed into all diodes. The wide range of available blocking voltages makes it possible to apply these diodes as output rectifiers in switch-mode power supplies (SMPS) as well as protective and free-wheeling diodes for power switches in inverters.

Diodes for General Purpose Applications

Rectifier Diodes

Diodes of the DS-series (anode on stud) and of the DSI-series (cathode on stud) are mainly used for rectifying 50 or 60 Hz mains currents. Discrete diodes in plastic and metal housings and also different diode bridges are available for standard line voltages (from 110 V to 690 V AC).

Avalanche Diodes

Avalanche diodes or surge-voltage-proof rectifier diodes of the series DSA (anode on stud) and DSAI (cathode on stud) differ from standard diodes of the series DS and DSI in the following manner: the operation in avalanche breakdown above the normal reverse blocking voltage (V_{RRM}) can be tolerated as long as the power is within the specified maximum permissible non-repetitive reverse surge dissipation P_{RSM} at the specified pulse width. In order to have technologically good control of the avalanche breakdown, it is important to ensure homogeneous doping of the middle zone of the silicon chip and suitable junction termination and passivation at the edges where PN-junctions are exposed to the surface (high field strength at the edge). Because of this ruggedness against periodically occurring short-term voltage surges in the blocking direction, the user frequently can do without protective overvoltage networks. In addition, if avalanche diodes are put in series for high voltage applications, the sharp avalanche breakdown of the blocking characteristic ensures static and dynamic voltage distribution uniformly across each device. Thus, in general, none of the series diodes will be overstressed by reverse voltages which are substantially above the avalanche voltage. All high voltage rectifier modules manufactured in quantity are assembled with avalanche diodes.

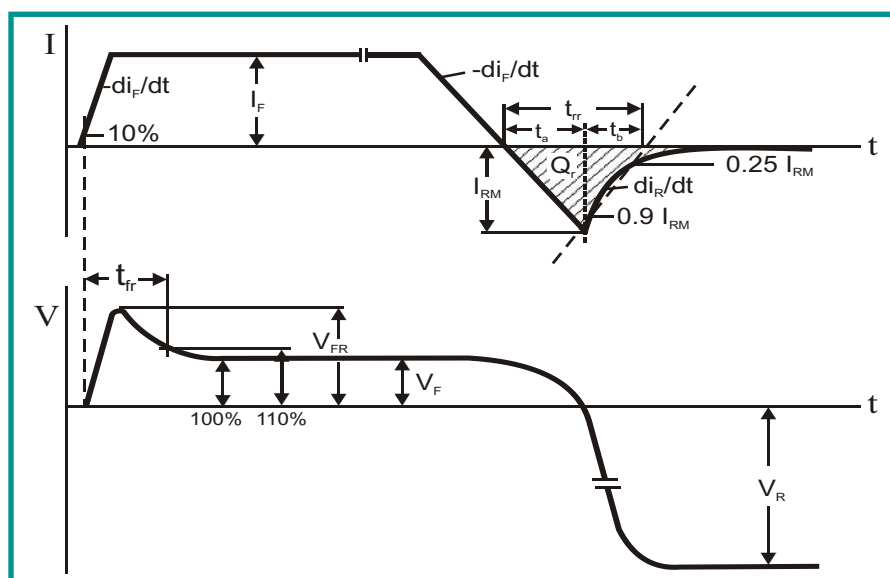
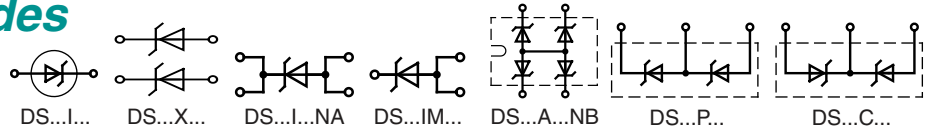











Fig. 1: Current and voltage during turn-on and turn-off switching of fast diodes

Schottky Gen² Diodes

$I_{FAV} = 10 - 300 \text{ A}$







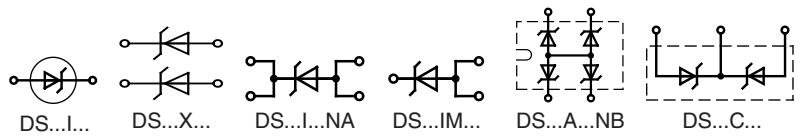

Type	V_{RRM}	I_{FAV}	@ T_C	V_F	@ I_F	T_{VJM}	R_{thJC}	Fig. No.	Package style Outline drawings on pages O-31...O-52
➤ New	V	A	°C	V	A	°C	K/W		
DSB 20I15PA DSB 40C15PB	15	20 2x 20	130 130	0.39 0.39	20 20	150 150	1.75 1.75	X005b X005a	X005a TO-220AB 
DSB 30C30PB DSB 60C30PB DSB 60C30HB	30	2x 15 2x 30 2x 30	130 130 125	0.44 0.49 0.47	15 30 30	150 150 150	1.75 0.85 0.95	X005a X005a X014a	
DSB 10I45PM DSA 20C45PB DSA 15I45PA DSA 15IM45IB DSB 15IM45IB DSA 30C45PB DSA 30C45PC DSB 30C45PB DSA 30C45HB DSB 30C45HB DSA 60C45PB DSB 60C45PB DSA 60C45HB DSB 60C45HB DSA 80C45HB DSB 80C45HB DSA 300I45NA	45	10 2x 10 15 15 15 2x 15 2x 15 2x 15 2x 15 2x 15 2x 30 2x 30 2x 30 2x 30 2x 40 2x 40 300	115 155 155 155 125 155 155 125 155 125 150 125 150 125 150 120 95	0.52 0.62 0.63 0.63 0.55 0.63 0.63 0.55 0.62 0.54 0.67 0.60 0.66 0.58 0.69 0.59 0.70	10 10 15 15 15 15 15 15 15 15 30 30 30 30 40 40 300	150 175 175 175 150 175 175 150 175 150 175 150 175 150 175 150 150	4.50 2.40 1.75 1.75 1.75 1.75 1.75 1.75 1.75 0.85 0.85 0.95 0.95 0.70 0.70 0.20	X007b X005a X005b X008a X008a X005a X011b X005a X014a X014a X005a X005a X014a X014a X014a X014a X027a	X005b TO-220AC  X007a TO-220ABFP  X007b TO-220ACFP  X008a TO-262AA (I²-PAK) 
DSB 10P60PN DSA 20C60PN DSB 20C60PN DSA 30C60PB DSB 30C60PB DSA 60C60PB DSB 60C60PB DSA 60C60HB DSB 60C60HB	2x 60 60	10 2x 10 2x 10 2x 15 2x 15 2x 30 2x 30 2x 30 2x 30	110 140 110 150 125 150 125 150 125	0.62 0.70 0.62 0.72 0.64 0.77 0.69 0.75 0.67	10 10 10 15 15 30 30 30 30	150 175 150 175 150 175 150 175 150	4.50 4.50 4.50 1.75 1.75 0.85 0.85 0.95 0.95	X007a X007a X007a X005a X005a X005a X005a X014a X014a	X007a TO-263AB  X014a TO-247AD 
DSA 10I100PM DSA 20C100PB DSA 20C100PN DSA 30C100PB DSA 30C100PN DSA 30C100HB DSA 30C100QB DSA 50C100HB DSA 50C100QB DSA 30I100PA DSA 60C100PB DSA 70C100HB DSA 80C100PB DSA 320A100NB ① DSA 300I100NA	100	10 2x 10 2x 10 2x 15 2x 15 2x 15 2x 15 2x 25 2x 25 30 2x 30 2x 35 2x 40 4x 80 300	135 155 135 150 120 150 150 155 155 150 150 150 150 85 90	0.71 0.71 0.71 0.73 0.73 0.72 0.72 0.72 0.72 0.78 0.78 0.74 0.80 0.77 0.79	10 10 10 15 15 15 15 25 25 30 30 35 40 80 300	175 175 175 175 175 175 175 175 175 175 175 175 175 150 150	4.50 2.40 4.50 1.75 4.25 1.75 1.75 0.95 0.95 0.85 0.85 0.70 0.60 0.80 0.20	X007b X005a X007a X005a X007a X014a X017a X014a X017a X005b X005a X014a X005a X027b X027a	X017a TO-3P  X027a/b SOT-227B miniBLOC 

① Non isolated base plate

Schottky Gen² Diodes

$I_{FAV} = 5 - 300 \text{ A}$



Type	V_{RRM}	I_{FAV} d = 0.5	@ T_C	V_F $T_{VJ} = 125^\circ\text{C}$	@ I_F	T_{VJM}	R_{thJC}	Fig. No.	Package style Outline drawings on pages O-31...O-52		
➤ New	V	A	°C	V	A	°C	K/W				
DSA 10C150PB	150	2x 5	155	0.71	5	175	4.80	X005a	X004 TO-252AA 		
DSA 20C150PB		2x 10	155	0.73	10	175	2.40	X005a			
DSA 20C150PN		2x 10	135	0.73	10	175	4.50	X007a			
DSA 30C150PB		2x 15	150	0.75	15	175	1.75	X005a			
DSA 30C150HB		2x 15	150	0.74	15	175	1.75	X014a			
DSA 50C150HB		2x 25	155	0.74	25	175	0.95	X014a			
DSA 30I150PA		30	150	0.80	30	175	0.85	X005b		X005a TO-220AB 	
DSA 60C150PB		2x 30	150	0.80	30	175	0.85	X005a			
DSA 70C150HB		2x 35	150	0.77	35	175	0.70	X014a			
DSA 120C150QB		2x 60	150	0.80	60	175	0.40	X017a			
DSA 120X150LB		2x 60	150	0.80	60	175	0.80	X030a			
DSA 600A150NB ①		4x 150	115	0.93	150	150	0.30	X027b	X005b TO-220AC 		
DSA 240X150NA		2x 120	95	0.85	120	150	0.40	X027a			
DSA 15IM200UC	200	15	145	0.78	15	175	2.00	X004	X007a TO-220ABFP 		
DSA 30C200IB		2x 15	150	0.78	15	175	1.75	X008a			
DSA 30C200PB		2x 15	150	0.78	15	175	1.75	X005a			
DSA 70C200HB		2x 35	150	0.79	35	175	0.70	X014a			
DSA 90C200HB		2x 45	145	0.86	45	175	0.55	X014a			
DSA 90C200HR		2x 45	140	0.79	45	175	0.70	X016c			
DSA 120X200LB		2x 60	150	0.87	60	175	0.80	X030a			
➤ DSA 240X200LB		2x 120	150	0.87	120	175	0.40	X030a			
DSA 240X200NA			2x 120	90	0.87	120	150	0.40		X027a	X008a TO-262AA (I²-PAK) 
DSA 300I200NA			300	80	0.88	300	150	0.20		X027a	

① Non isolated base plate

X017a **TO-3P**



X016c **ISO247™**



X014a **TO-247AD**



X030a **SMPD-B**



X027a/b **SOT-227B
miniBLOC**



Schottky Diodes

$$I_{FAV} = 6 - 2 \times 200 \text{ A}$$

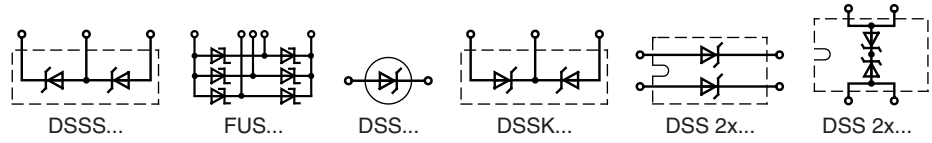

Type	V_{RRM} V	I_{FAV} A d = 0.5	@ T_C °C	V_F V $T_{VJ} = 125^\circ\text{C}$	@ I_F A	T_{VJM} °C	R_{thJC} K/W	Fig. No.	Package style Outline drawings on pages O-31...O-52
DSS 40-0008D DSSK 80-0008D DSS 2x200-0008D ①	8	40 2x 40 2x 200	130 130 90	0.28 0.28 0.28	40 40 100	150 150 150	0.80 0.80 0.40	X014a X014a X027b	X004 TO-252AA
DSS 20-0015B DSSK 40-0015B DSSK 70-0015B	15	20 2x 20 2x 35	135 135 130	0.33 0.32 0.35	20 20 35	150 150 150	1.40 1.40 1.10	X005b X014a X014a	X005a TO-220AB
DSS 6-0025BS DSS 25-0025B DSSK 18-0025BS DSSK 38-0025B DSSK 38-0025BS DSSK 48-0025B DSSK 50-0025B DSSK 80-0025B	25	6 25 2x 10 2x 20 2x 20 2x 25 2x 25 2x 40	140 125 140 130 130 130 125 130	0.30 0.45 0.37 0.40 0.40 0.35 0.43 0.39	6 25 10 20 20 20 25 40	150 150 150 150 150 150 150 150	3.00 1.40 1.70 1.40 1.40 1.20 1.40 0.80	X004 X005b X011b X005a X011b X005a X014a X014a	X005b TO-220AC
DSSK 48-003B DSSK 48-003BS DSSK 70-003B DSSK 80-003B	30	2x 25 2x 25 2x 35 2x 40	130 130 125 130	0.35 0.35 0.39 0.39	20 20 35 40	150 150 150 150	1.20 1.20 1.10 0.80	X005a X011b X014a X014a	X010b ISOPLUS220™
DSS 6-0045AS DSS 10-0045B DSS 16-0045A DSS 16-0045AS DSS 25-0045A DSS 60-0045B DSSK 20-0045B DSSK 28-0045BS DSSK 60-0045A DSSK 60-0045B DSSK 80-0045B DSS 2x61-0045A DSS 2x81-0045B DSS 2x121-0045B DSS 2x160-0045A ① FUS 45-0045B	45	6 10 16 16 25 60 2x 10 2x 15 2x 30 2x 30 2x 40 2x 60 2x 80 2x 120 2x 160 45	165 135 160 160 155 105 135 135 150 125 125 110 85 100 90 90	0.50 0.46 0.56 0.56 0.56 0.57 0.46 0.43 0.58 0.45 0.46 0.65 0.63 0.59 0.72 0.54	6 10 16 16 25 60 10 15 30 30 40 60 80 120 160 15	175 150 175 175 175 150 150 150 175 150 150 150 150 150 150 150	3.00 1.70 1.40 1.40 1.10 0.80 1.70 1.40 1.10 1.10 0.80 0.80 0.80 0.40 0.40 3.10	X004 X005b X005b X011b X005b X014b X005a X011b X014a X014a X014a X027a X027a X027a X027b X024a	X011b TO-263AB
DSS 10-006A DSSK 28-006BS DSSK 40-006B DSSK 80-006B DSSK 80-006BR	60	10 2x 15 2x 20 2x 40 2x 40	160 135 135 120 120	0.65 0.52 0.46 0.51 0.51	10 15 20 40 40	175 150 150 150 150	1.70 1.40 1.10 0.80 0.80	X005b X011b X014a X014a X016a	X014a TO-247AD
DSSK 40-008B DSSS 35-008AR DSSK 70-008A DSSK 70-008AR DSS 2x111-008A	80 2x 80	2x 20 35 2x 35 2x 35 2x 110	130 150 150 150 105	0.52 0.68 0.64 0.64 0.72	20 35 35 35 100	150 175 175 175 150	1.10 0.80 0.80 0.80 0.40	X014a X016a X014a X016a X027a	X016a ISOPLUS247™
DSS 10-01A DSS 10-01AS DSS 16-01A DSS 16-01AS DSS 20-01AC DSSS 30-01AR	100 2x 100	10 10 16 16 20 30	160 160 155 155 140 155	0.66 0.66 0.65 0.65 0.80 0.63	10 10 16 16 20 30	175 175 175 175 175 175	1.70 1.70 1.40 1.40 1.70 0.80	X005b X011b X005b X011b X010b X016a	X024a ISOPLUS i4-PAC™
DSSK 16-01A DSSK 16-01AS DSSK 28-01AS DSSK 30-01A DSSK 50-01A DSS 2x41-01A DSS 2x61-01A DSS 2x160-01A ①		2x 8 2x 8 2x 15 2x 15 2x 25 2x 40 2x 60 2x 160	165 165 160 160 155 110 105 80	0.63 0.63 0.64 0.63 0.64 0.70 0.74 0.81	8 8 15 15 25 40 60 160	175 175 175 175 175 150 150 150	1.70 1.70 1.40 1.40 1.10 1.10 0.80 0.40	X005a X011b X011b X014a X014a X027a X027a X027b	X027a/b SOT-227B/UI miniBLOC

① Non isolated base plate

Schottky Diodes

$I_{FAV} = 6 - 2x 100 A$

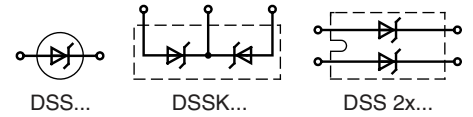

Type	V_{RRM} V	I_{FAV} d = 0.5 A	@ T_C °C	V_F $T_{VJ} = 125^\circ C$ V	@ I_F A	T_{VJM} °C	R_{thJC} K/W	Fig. No.	Package style Outline drawings on pages O-31...O-52
DSS 6-015AS	150	6	160	0.62	6	175	3.00	X004	X004 TO-252AA
DSSK 20-015A		2x 10	165	0.61	10	175	1.40	X005a	
DSSK 50-015A		2x 25	150	0.68	25	175	1.10	X014a	
DSSK 60-015A		2x 30	155	0.66	30	175	0.80	X014a	
DSSK 60-015AR		2x 30	155	0.66	30	175	0.80	X016a	
DSS 2x101-015A		2x 100	110	0.77	100	150	0.40	X027a	X005a TO-220AB
DSSK 10-018A	180	2x 5	165	0.60	5	175	1.70	X005a	
DSSK 30-018A		2x 15	150	0.74	15	175	1.70	X014a	
DSSK 60-02A	200	2x 30	155	0.70	30	175	0.80	X014a	X010a ISOPLUS220™
DSSK 60-02AR		2x 30	155	0.70	30	175	0.80	X016a	
DSS 2x101-02A		2x 100	105	0.84	100	150	0.40	X027a	

Silicon Carbide Schottky Diodes

No reverse recovery

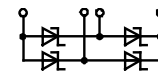

Type	V_{RRM} V	I_{FAV} d = 0.5 A	@ T_C °C	V_F typ., $T_{VJ} = 125^\circ C$ V	@ I_F A	C_J pF	R_{thJC} K/W	Fig. No.
➤ New								
FBS 10-06SC	600	3.0	90	1.70	4.0	9	8.00	X024a
FBS 16-06SC		5.0	90	1.50	6.0	21	5.60	
FBS 10-12SC	1200	4.5	80	2.61	5.0	33	7.00	

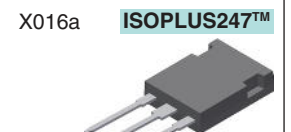
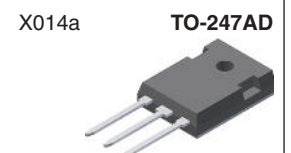

HiPerDyn™ FRED

Series connected diodes for high switching frequencies; packages isolated ($2500 V_{RMS}$)

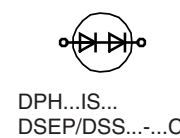
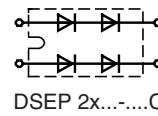

Type	V_{RRM} V	I_{FAV} d = 0.5 A	@ T_C °C	V_F $I_F = I_{FAV}$ V	@ T_{VJ} °C	t_{rr} typ. $T_{VJ} = 25^\circ C$ ns	I_{RM} typ. A	@ -di/dt A/μs	T_{VJM} °C	R_{thJC} K/W	Fig. No.
➤ New											
DSS 17-06CR *	600	17	95	2.71	125	45	2.0	100	175	1.40	X016b
DPH 30IS600HI		30	140	1.89	150	35	3.0	200	175	0.55	
DSEP 15-12CR	1200	15	135	2.67	150	15	10.0	600	175	1.00	X016c
DSEP 30-12CR		30	120	3.18	150	15	5.5	600	175	0.60	
DSEP 2x25-12C	1200	2x 25	90	2.95	150	15	5.5	600	150	0.60	X027a
➤ DPJ 50XS1800NA	1800	2x 25	90	4.33	150	15	4.0	600	150	0.40	

* series connected Schottky Diodes

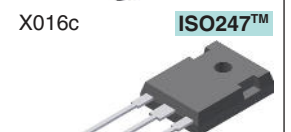

Dual Ultrafast Diodes

Series connected diodes for high switching frequencies with middle connection; packages isolated ($2500 V_{RMS}$)

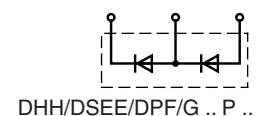

DPG 30P300PJ	2x 300	30	135	0.99	150	35	3.0	200	175	1.05	X010a
DPG 10P400PJ	2x 400	10	145	1.03	150	45	4.0	200	175	2.50	
DSEE 15-12CC	2x 600	15	100	1.50	125	35	4.0	100	175	1.60	X016c
DSEE 29-12CC		30	90	1.75	125	30	4.0	100	175	0.90	
DPF 30P600HR		30	130	1.27	150	35	17	600	175	0.90	X014a
DSEE 30-12A ①		30	90	1.78	125	30	4.0	100	175	0.90	
DSEE 55-24N1F	2x 1200	60	110	1.56	150	75	35	600	175	0.60	X024b
DHH 55-36N1F	2x 1800	60	50	2.06	125	230	60	800	150	0.60	

① Non isolated base plate



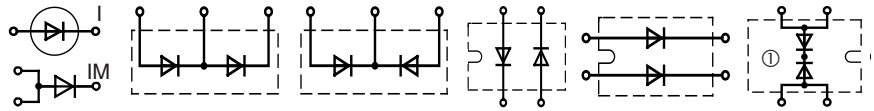

$I_{FAV} = 10 - 2x 200 A$

Type	V_{RRM}	I_{FAV}	@ T_C	I_{FSM}	V_F	@ I_F	t_{rr}	I_{RM}	$-di/dt$	T_{VJM}	R_{thJC}	Fig. No.	Package style	
➤ New	V	A	d = 0.5 °C	10 ms 45°C A	$T_{VJ} = 150°C$ V	A	ns	typ. $T_{VJ} = 25°C$ A	A/ μ s	°C	K/W		Outline drawings on pages O-31...O-52	
DPG 10I200PA	200	10	145	140	0.98	10	35	3.0	200	175	2.30	X005b	X004 TO-252AA X007b TO-220AB X005a TO-220AC X007a TO-220ABFP X007b TO-220ACFP X010a ISOPLUS220™ X011b TO-263AB X014a TO-247AD X014b TO-247AD X017a TO-3P X027a/b SOT-227B/UI miniBLOC 	
DPG 10I200PM		10	125	140	0.98	10	35	3.0	200	175	4.40	X007b		
DPG 20C200PB		2x 10	145	140	0.98	10	35	3.0	200	175	2.30	X005a		
DPG 20C200PN		2x 10	125	140	0.98	10	35	3.0	200	175	4.40	X007a		
DPG 15I200PA		15	140	240	1.01	15	35	3.0	200	175	1.70	X005b		
DPG 30C200PB		2x 15	140	240	1.01	15	35	3.0	200	175	1.70	X005a		
DPG 30C200PC		2x 15	140	240	1.01	15	35	3.0	130	175	1.70	X011b		
DPG 30C200HB		2x 15	140	240	1.00	15	35	3.0	200	175	1.70	X014a		
DPF 60C200HB		2x 30	130	400	0.98	30	35	4.0	200	175	0.95	X014a		
DPF 60C200HJ		2x 30	130	560	0.88	30	35	4.0	200	175	1.05	X016a		
DPG 60C200HB		2x 30	135	360	1.06	30	35	3.0	200	175	0.95	X014a		
DPG 60C200QB		2x 30	135	360	1.06	30	35	3.0	200	175	0.95	X017a		
DPF 80C200HB		2x 40	140	560	0.95	40	35	4.0	200	175	0.70	X014a		
DPF 60I200HA		60	135	650	0.98	60	35	4.0	200	175	0.55	X014b		
➤ DPF 120X200NA		2x 60	120	1200	0.90	60	35	4.0	200	175	0.60	X027a		
DPF 240X200NA		2x 120	120	1800	0.90	120	35	4.0	200	175	0.45	X027a		
DPG 10I300PA	300	10	145	140	0.98	10	35	3.0	200	175	2.30	X005b	X007b TO-220ACFP X010a ISOPLUS220™ X011b TO-263AB X014a TO-247AD X014b TO-247AD X017a TO-3P X027a/b SOT-227B/UI miniBLOC 	
DPG 10I300UC		10	150	140	0.98	10	35	3.0	200	175	2.30	X004		
DPG 20C300PB		2x 10	145	140	0.98	10	35	3.0	200	175	2.30	X005a		
DPG 20C300PN		2x 10	125	140	0.98	10	35	3.0	200	175	4.40	X007a		
DPG 15I300PA		15	140	240	1.01	15	35	3.0	200	175	1.70	X005b		
DPG 30C300PB		2x 15	140	240	1.01	15	35	3.0	200	175	1.70	X005a		
DPG 30C300PC		2x 15	140	240	1.01	15	35	3.0	200	175	1.70	X011b		
DPG 30C300HB		2x 15	140	240	1.00	15	35	3.0	200	175	1.70	X014a		
DPF 30I300PA		30	145	390	0.98	30	55	6.0	200	175	0.85	X005b		
DPG 30I300HA		30	135	360	1.06	30	35	3.0	200	175	0.95	X014b		
DPG 30I300PA		30	140	360	1.08	30	35	3.0	200	175	0.85	X005b		
DPG 30IM300PC		30	140	360	1.08	30	35	3.0	200	175	0.85	X011b		
DPG 30P300PJ		2x 300	30	135	450	0.99	30	35	3.0	200	175	1.05		X010a
DPF 60C300HB		2x 30	140	400	0.97	30	55	6.0	200	175	0.95	X014a		
DPG 60C300HB		2x 30	135	360	1.06	30	35	3.0	200	175	0.95	X014a		
DPG 60C300HJ		2x 30	135	450	0.96	30	35	3.0	200	175	1.05	X016a		
DPG 60C300PC	2x 30	140	360	1.08	30	35	3.0	200	175	0.85	X011b			
DPG 60C300QB	2x 30	135	360	1.06	30	35	3.0	200	175	0.95	X017a			
DPG 80C300HB	2x 40	135	450	1.07	40	35	3.0	200	175	0.70	X014a			
DPG 60I300HA	60	125	450	1.10	60	35	3.5	200	175	0.55	X014b			
DPG 60IM300PC	60	135	450	1.14	60	35	3.5	200	175	0.45	X011b			
DPG 120C300QB	2x 60	125	450	1.10	60	35	3.5	200	175	0.55	X017a			
DPG 10I400PA	400	10	145	150	1.03	10	45	4.0	200	175	2.30	X005b	X016a ISOPLUS247™ X016b ISOPLUS247™ X017a TO-3P X027a/b SOT-227B/UI miniBLOC 	
DPG 10I400PM		10	120	150	1.03	10	45	4.0	200	175	4.40	X007b		
DPG 10P400PJ		2x 400	10	145	130	1.03	10	45	4.0	200	175	2.50		X010a
DPG 20C400PB		2x 10	145	150	1.03	10	45	4.0	200	175	2.30	X005a		
DPG 20C400PC		2x 10	145	150	1.03	10	45	4.0	200	175	2.30	X011b		
DPG 20C400PN		2x 10	120	150	1.03	10	45	4.0	200	175	4.40	X007a		
DPG 15I400PM		15	90	190	1.14	15	45	4.0	200	175	4.20	X007b		
DPG 30C400PB		2x 15	140	190	1.14	15	45	4.0	200	175	1.70	X005a		
DPG 30C400HB		2x 15	140	190	1.13	15	45	4.0	200	175	1.70	X014a		
DPG 30I400HA		30	135	360	1.13	30	45	4.0	200	175	0.95	X014b		
➤ DPG 30IM400PC		30	145	300	1.16	30	45	4.0	200	175	0.85	X011b		
➤ DPF 60XA400NA		2x 30	130	400	1.00	30	60	6.0	200	175	1.15	X027a		
DPG 60C400HB		2x 30	135	360	1.13	30	45	4.0	200	175	0.95	X014a		
DPG 60C400QB		2x 30	135	360	1.13	30	45	4.0	200	175	0.95	X017a		
DPG 80C400HB		2x 40	135	400	1.14	40	45	4.0	200	175	0.70	X014a		
DPG 60I400HA		60	120	450	1.22	60	45	4.0	200	175	0.55	X014b		
DPF 60IM400HB	60	130	600	1.09	60	60	6.0	200	175	0.55	X014a			
DPG 60IM400QB	60	120	450	1.22	60	45	4.0	200	175	0.55	X017a			
➤ DPF 120X400NA	2x 60	120	530	0.95	60	60	6.0	200	175	0.60	X027a			
DPF 240X400NA	2x 120	120	1100	0.95	120	60	6.0	200	175	0.45	X027a			
➤ DPF 400C400NB ①	2x 200	130	1600	0.90	200	60	6.0	200	175	0.20	X027b			
DPH 30IS600HI	600	30	140	450	1.89	30	35	3.0	200	175	0.55	X016b		

① Non isolated base plate

HiPerFRED™ Diodes

$$I_{FAV} = 8 - 2x \ 120 \ A$$

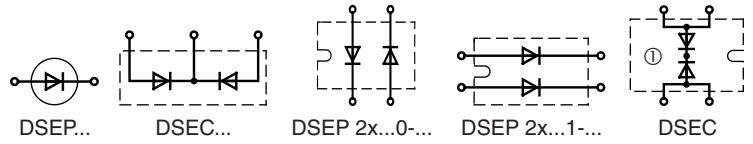





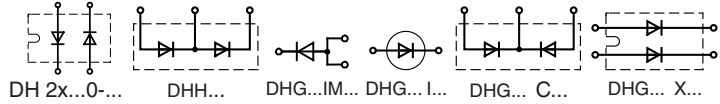

Type	V _{RRM}	I _{FAV}	T _C	I _{FSM}	V _F	@ I _F	t _{rr}	I _{RM}	-di/dt	T _{vJM}	R _{thJC}	Fig. No.	Package style
➤ New	V	A	°C	10 ms 45°C	V	A	ns	typ. A	typ. A/μs	°C	K/W		Outline drawings on pages O-31...O-52
DSEP 40-03AS	300	40	125	340	1.18	40	35	3.5	200	175	0.85	X011b	X004 TO-252AA
DSEP 6-06AS	600	6	150	40	1.34	6	20	3.5	100	175	2.80	X004	X005a TO-220AB
DSEP 6-06BS		6	140	40	1.77	6	15	2.0	100	175	2.80	X004	
DSEP 8-06A	600	10	145	50	1.42	10	35	3.5	100	175	2.50	X005b	X005b TO-220AB
DSEP 8-06B		10	130	50	1.85	10	30	2.0	100	175	2.50	X005b	
DSEP 15-06A	600	15	140	110	1.35	15	35	4.0	100	175	1.60	X005b	X005b TO-220AC
DSEP 15-06AS		15	140	110	1.35	15	35	4.0	100	175	1.60	X011b	
DSEP 15-06B	600	15	130	110	1.59	15	25	2.0	100	175	1.60	X005b	X005b TO-220AC
DSEP 15-06BS		15	130	110	1.59	15	25	2.0	100	175	1.60	X011b	
DSEP 29-06A	600	30	135	250	1.26	30	35	5.5	100	175	0.90	X005b	X010a ISOPLUS220™
DSEP 29-06AS		30	135	250	1.26	30	35	5.5	100	175	0.90	X011b	
DSEP 29-06B	600	30	120	250	1.63	30	30	3.0	100	175	0.90	X005b	X010a ISOPLUS220™
DSEP 30-06A		30	135	250	1.25	30	35	5.5	100	175	0.90	X014b	
DSEP 30-06B	600	30	120	250	1.61	30	30	3.0	100	175	0.90	X014b	X011b TO-263AB
DSEP 30-06BR		30	100	250	1.61	30	30	3.0	100	175	1.10	X016b	
DSEP 60-06A	600	60	110	600	1.39	60	35	5.5	100	175	0.65	X014b	X011b TO-263AB
DSEP 60-06AT		60	110	600	1.39	60	35	5.5	100	175	0.65	X019	
➤ DSEP 75-06AR	600	75	115	1000	1.38	75	35	6.5	200	175	0.50	X016a	X011c TO-263ABHV
DSEP 8-12A		10	130	40	1.96	10	40	4.0	100	175	2.50	X005b	
DSEP 12-12A	1200	15	130	90	1.87	15	40	4.5	100	175	1.60	X005b	X011c TO-263ABHV
DSEP 12-12AZ		15	130	90	1.87	15	40	4.5	100	175	1.60	X011c	
DSEP 12-12B	1200	15	130	90	2.06	15	35	3.0	100	175	1.60	X005b	X014a TO-247AD
DSEP 12-12BZ		15	130	90	2.06	15	35	3.0	100	175	1.60	X011c	
DSEP 29-12A	1200	30	120	200	1.81	30	40	8.5	100	175	0.90	X005b	X014a TO-247AD
DSEP 30-12A		30	115	200	1.79	30	40	8.5	100	175	0.90	X014b	
DSEP 30-12AR	1200	30	100	200	1.79	30	40	8.5	100	175	1.10	X016b	X014a TO-247AD
DSEP 60-12A		60	85	500	1.81	60	40	7.0	100	175	0.65	X014b	
DSEP 60-12AR	1200	60	60	500	1.81	60	40	7.0	100	175	0.80	X016b	X014b TO-247AD
DSEC 16-06A		600	2x 10	145	50	1.42	10	35	3.5	100	175	2.50	
DSEC 16-06AC	600	2x 8	85	50	1.20	10	35	3.5	100	175	3.00	X010a	X014b TO-247AD
DSEC 29-06AC		2x 15	140	110	1.34	15	35	4.0	100	175	1.60	X010a	
DSEC 30-06A	600	2x 15	140	110	1.34	15	35	4.0	100	175	1.60	X014a	X014a TO-247AD
DSEC 30-06B		2x 15	130	110	1.58	15	25	2.0	100	175	1.60	X014a	
DSEC 59-06BC	600	2x 30	105	200	1.56	30	30	4.0	100	175	1.10	X010a	X016a/b ISOPLUS247™
DSEC 60-06A		2x 30	135	250	1.25	30	35	5.5	100	175	0.90	X014a	
DSEC 60-06B	600	2x 30	120	250	1.61	30	30	3.0	100	175	0.90	X014a	X019 TO-268AA
DSEC 16-12A		1200	2x 10	130	40	1.96	10	40	4.0	100	175	2.50	
DSEC 16-12AS	1200	2x 10	130	40	1.96	10	40	4.0	100	175	2.50	X011b	X019 TO-268AA
DSEC 30-12A		2x 15	115	90	1.86	15	40	4.5	100	175	1.60	X014a	
DSEC 60-12A	1200	2x 30	115	200	1.79	30	40	8.5	100	175	0.90	X014a	X020a TO-264
DSEC 120-12AK		2x 60	85	500	1.81	60	40	7.0	100	175	0.65	X020a	
DSEP 2x31-03A	300	2x 30	110	300	0.90	30	30	4.5	100	150	1.15	X027a	X020a TO-264
DSEP 2x61-03A	300	2x 60	75	600	1.26	60	30	4.0	100	150	0.85	X027a/b	
DSEP 2x91-03A		2x 90	70	1000	1.10	90	30	4.5	100	150	0.60		
DSEP 2x31-06A	600	2x 30	95	250	1.23	30	35	5.5	100	150	1.15	X027a/b SOT-227B/UI miniBLOC	
DSEP 2x31-06B		2x 30	75	250	1.59	30	30	3.0	100	150	1.15		
DSEP 2x61-06A	600	2x 60	65	600	1.48	60	35	5.5	100	150	0.85	X027a/b SOT-227B/UI miniBLOC	
DSEP 2x91-06A		2x 90	55	1000	1.39	90	35	8.0	100	150	0.60		
DSEP 2x31-12A	1200	2x 30	70	200	1.77	30	40	8.5	100	150	1.15	X027a/b SOT-227B/UI miniBLOC	
DSEP 2x60-12A		2x 60	80	800	1.52	60	40	8.0	100	150	0.60		
DSEP 2x61-12A	1200	2x 60	80	800	1.52	60	40	8.0	100	150	0.60	X027b	
DSEP 2x101-04A		400	2x 100	45	1000	1.22	125	30	5.5	100	150		0.60
DSEC 240-04A ①	600	2x 120	75	2000	1.00	120	30	5.5	100	150	0.45	X027b	
DSEC 240-06A ①		2x 120	75	2000	1.26	120	35	8.0	100	150	0.40		

① Non isolated base plate

SONIC-FRD™ Diodes

$I_{FAV} = 5 - 2x 60 A$ • ultrasoft and fast recovery
• very low temperature dependence



Type	V_{RRM}	I_{FAV}	@ T_C	I_{FSM}	V_F	@ I_F	t_{rr}	I_{RM}	$-di/dt$	T_{VJM}	R_{thJC}	Fig. No.	Package style		
														$d = 0.5$	10 ms 45°C
➤ New	V	A	°C	A	V	A	ns	A	A/ μ s	°C	K/W		Outline drawings on pages O-31...O-52		
DHG 5I600PA	600	5	105	40	2.17	5	35	2	100	150	3.15	X005b	 TO-220AB		
DHG 5I600PM		5	85	40	2.17	5		2	100		4.20	X007b			
DHG 10C600PB		2x 5	105	40	2.17	5		2	100		3.15	X005a			
DHG 10I600PA		10	95	80	2.18	10		4	200		1.80	X005b			
DHG 10I600PM		10	25	80	2.18	10		4	200		4.00	X007b			
DHG 20C600PB		2x 10	95	80	2.18	10		4	200		1.80	X005a			
DHG 20C600QB		2x 10	95	80	2.17	10		4	200		1.80	X017a			
DHG 20I600PA		20	100	150	2.21	20		8	400		0.80	X005b			
DHG 20I600HA		20	95	150	2.19	20		8	400		0.90	X014b		X005b	 TO-220AC
DHG 40C600PB		2x 20	100	150	2.21	20		8	400		0.80	X005a			
DHG 40C600HB		2x 20	95	150	2.19	20		8	400		0.90	X014a			
DHG 50X600NA		2x 25	70	200	2.03	25		12	600		1.20	X027a			
DHG 30I600PA		30	95	200	2.24	30		12	600		0.60	X005b			
DHG 30IM600PC		30	95	200	2.22	30		12	600		0.60	X011b			
DHG 30I600HA		30	85	200	2.21	30		12	600		0.70	X014b		X007b	 TO-220ACFP
DHG 60C600HB		2x 30	85	200	2.21	30		12	600		0.70	X014a			
DHG 100X600NA	2x 50	80	430	2.00	50	20	1200	0.60	X027a						
DHG 60I600HA	60	95	430	2.10	60	24	1200	0.30	X014b						
DHG 10I1200PA	1200	10	95	65	2.13	10	75	8	350	150	1.80	X005b	 TO-263AB		
DHG 10I1200PM		10	30	65	2.13	10		8	350		4.00	X007b			
DHG 20C1200PB		2x 10	95	65	2.13	10		8	350		1.80	X005a			
DHG 20I1200PA		20	105	135	2.16	20		19	750		0.80	X005b		X011b	
DHG 20I1200HA		20	95	135	2.14	20		19	750		0.90	X014b			
DHG 40C1200HB		2x 20	95	135	2.14	20		19	750		0.90	X014a			
DHG 50X1200NA		2x 25	70	180	2.00	25		25	1000		1.20	X027a			
DHG 30I1200HA		30	90	180	2.16	30		25	1000		0.70	X014b			
DHG 100X1200NA		2x 50	65	430	2.05	50		50	2500		0.60	X027a			
DHG 60I1200HA		60	95	430	2.22	60		50	2500		0.30	X014b		X014a	 TO-247AD
DHG 10I1800PA	1800	10	85	65	2.30	10	150	8	200	150	2.15	X005b			
DH 20-18A	1800	20	80	150	2.94	20	16	300	0.90	X014b					
DH 40-18A	1800	40	85	350	2.69	40	33	400	0.45	X014b					
DH 60-14A	1400	60	100	700	2.05	60	60	800	0.30	X014b					
DH 60-16A	1600	60	100	700	2.05	60	60	800	0.30	X014b					
DH 60-18A	1800	60	100	700	2.05	60	60	800	0.30	X014b					
DHG 55-36N1F	2x 1800	60	50	700	2.05	60	60	800	0.60	X024b	X014b	 TO-247AD			
DH 2x60-18A	1800	2x 60	55	700	2.02	60	60	800	0.60	X027a					
DH 2x61-16A	1600	2x 60	55	700	2.02	60	60	800	0.60	X027a					
DH 2x61-18A	1800	2x 60	55	700	2.02	60	60	800	0.60	X027a					

X027a **SOT-227B miniBLOC**



X024b **ISOPLUS i4-PAC™**



X017a **TO-3P**



FRED Diodes

Fast Recovery Epitaxial Diodes



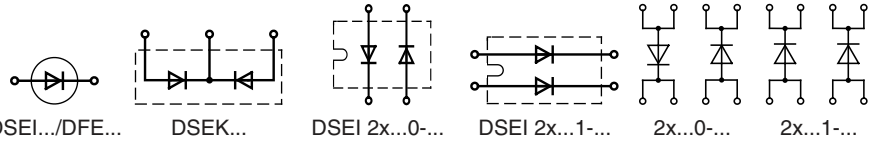



$I_{FAV} = 8 - 2x 165 A$



Type	V_{RRM}	I_{FAV}		I_{FRMS}	I_{FSM}	V_F		t_{rr} typ. $T_{VJ} = 25^\circ C$	$-di/dt$		R_{thJC}	Fig. No.	Package style Outline drawings on pages O-31...O-52		
		@ T_C d = 0.5				$T_{VJ} = 150^\circ C$			typ. $T_{VJ} = 100^\circ C$						
➤ New	V	A	$^\circ C$	A	A	V	A	ns	A	A/ μs	K/W				
DSEI 8-06A	600	8	115	16	100	1.30	8	35	2.5	64	2.50	X005b	X014a	TO-247AD	
DSEI 8-06AS	600	8	115	16	100	1.30	8	35	2.5	64	2.50	X011b			
DFE 10I600PM	600	10	100	16	100	1.30	10	35	2.5	64	4.20	X007b			
DSEI 12-06A	600	14	100	25	100	1.50	16	35	4.0	100	2.00	X005b	X014b	TO-247AD	
DSEI 12-06AS	600	14	100	25	100	1.50	16	35	4.0	100	2.00	X011b			
DSEI 12-10A	1000	12	100	25	75	2.10	12	50	6.5	100	1.60	X005b			
DSEI 12-12A	1200	11	100	25	75	2.20	12	50	6.5	100	1.60	X011c			
DSEI 12-12AZ	1200	11	100	25	75	2.20	12	50	6.5	100	1.60	X011c			
DSEI 20-12A	1200	17	85	70	130	1.87	12	40	7.0	100	1.60	X005b			
DSEI 19-06AS	600	20	65	25	100	1.50	16	35	4.0	100	2.00	X011b			
DSEI 36-06AS	600	37	85	70	300	1.40	37	35	10.0	240	1.00				
➤ DFE 30I600QA	600	30	90	70	300	135	30	35	10.0	240	1.00	X017b	X016a	ISOPLUS247™	
➤ DFE 30I600QM	600	30	45	70	300	135	30	35	10.0	240	2.50	X017d			
DSEI 30-06A	600	37	85	70	300	1.40	37	35	10.0	240	1.00	X014b			
DSEI 30-10A	1000	30	85	70	200	2.00	36	35	16.0	240	0.90				
DSEI 30-10AR	1000	30	85	70	200	2.00	36	35	16.0	240	0.90	X016b			
DSEI 30-12A	1200	26	85	70	200	2.20	30	40	16.0	240	0.90	X014b	X016b	ISOPLUS247™	
DSEI 60-02A	200	69	85	98	600	0.88	60	35	8.0	200	0.75	X014b			
DSEI 60-06A	600	60	70	100	550	1.50	70	35	19.0	480	0.75				
DSEI 60-10A	1000	60	60	100	500	1.80	60	35	32.0	480	0.66				
DSEI 60-12A	1200	52	60	100	500	2.00	60	40	32.0	480	0.66				
DSEI 120-06A	600	126	70	100	600	1.12	70	35	17.0	200	0.35				
DSEI 120-12A	1200	109	60	100	600	1.55	70	40	25.0	200	0.35		X017b	TO-3P	
DSEK 60-02A	200	2x 34	115	50	325	0.85	30	35	4.0	100	1.00	X014a			
DSEK 60-02AR	200	2x 34	115	50	325	0.85	30	35	4.0	100	1.00	X016a			
DSEK 60-06A	600	2x 30	85	50	300	1.40	37	35	10.0	240	1.00	X014a			
DSEK 60-12A	1200	2x 26	85	50	200	2.20	30	40	16.0	240	0.90				
DSEI 2x30-04C	400	2x 30	85	70	300	1.40	30	35	10.0	240	1.25	X027a	X017d	TO-3PFP	
DSEI 2x30-06C	600	2x 30	85	70	300	1.40	30	35	10.0	240	1.25				
DSEI 2x30-10B	1000	2x 30	50	70	200	2.00	30	35	16.0	240	1.25				
DSEI 2x30-12B	1200	2x 28	50	70	200	2.20	30	40	16.0	240	1.25				
DSEI 2x31-04C	400	2x 30	85	70	300	1.40	30	35	10.0	240	1.25				
DSEI 2x31-06C	600	2x 30	85	70	300	1.40	30	35	10.0	240	1.25				
DSEI 2x31-10B	1000	2x 30	50	70	200	2.00	30	35	16.0	240	1.25				
DSEI 2x31-12B	1200	2x 28	50	70	200	2.20	30	40	16.0	240	1.25				
DSEI 2x61-02A	200	2x 71	85	100	950	0.88	60	35	8.0	200	0.80		X027a	SOT-227B miniBLOC	
DSEI 2x60-04C	400	2x 60	70	100	550	1.50	60	35	19.0	480	0.70				
DSEI 2x61-04C	400	2x 60	70	100	550	1.50	60	35	19.0	480	0.70				
DSEI 2x61-06C	600	2x 60	70	100	550	1.50	60	35	19.0	480	0.70				
DSEI 2x61-10B	1000	2x 60	50	100	500	1.80	60	35	32.0	480	0.70				
DSEI 2x61-12B	1200	2x 52	50	100	450	2.15	60	40	32.0	480	0.70		X101	ECO-PAC 1	
DSEI 2x61-06P	600	2x 60	70	100	550	1.50	60	35	19.0	480	0.70	X101			
DSEI 2x61-12P	1200	2x 52	50	100	450	2.15	60	40	32.0	540	0.70				
DSEI 2x121-02A	200	2x 123	70	150	1200	0.95	120	35	12.0	200	0.50	X027a			
DSEI 2x101-06A	600	2x 96	70	150	1200	1.17	100	35	19.0	200	0.50		X102	See data sheet for pin arrangement	
DSEI 2x101-12A	1200	2x 91	50	130	900	1.61	100	40	24.0	200	0.50				
DSEI 2x101-06P	600	2x 96	70	150	1200	1.17	100	40	19.0	200	0.50				
DSEI 2x101-12P	1200	2x 91	50	130	900	1.61	100	40	24.0	200	0.50				
DSEI 2x161-02P	200	2x 165	70	270	1200	1.05	200	35	20.0	200	0.29		X102	ECO-PAC 2	
DSEI 2x161-06P	600	2x 147	70	270	1200	1.40	200	35	45.0	200	0.29				
DSEI 2x161-12P	1200	2x 128	70	270	1200	1.75	200	40	48.0	200	0.29				
X005b	TO-220AC	X007b	TO-220ACFP	X011b	TO-263AB	X011c	TO-263ABHV								

FRED & HiPerFRED™ Modules

$I_{FAV} = 75 - 582 \text{ A}$

Type	V_{RRM}	I_{FAV}	@ T_C	I_{FRMS}	I_{FSM}	V_F	@ I_F	t_{rr}	I_{RM}	$-di/dt$	R_{thJC}	P_{tot}	Fig. No.	Package style	
	V	A	°C	A	A	V	A	ns	A	A/ μ s	K/W	W		Outline drawings on pages O-31...O-52	
FRED															
MEO 550-02DA	200	582	75	822	4800	1.08	520	150	15	200	0.071	1750	X126d	X125e TO-240 	
MEO 500-06DA	600	514	75	726	4800	1.41	520	250	132	800	0.071	1750			
MEO 450-12DA	1200	453	75	640	4800	1.76	520	450	165	800	0.071	1750			
MEK 75-12DA	1200	2x 75	75	107	1200	1.85	100	250	33	200	0.45	280	X125e	X125e TO-240 	
MEA 75-12DA	1200	2x 75													
MEE 75-12DA	2x 1200	75													
MEK 95-06DA	600	2x 95	75	142	1200	1.36	100	250	21	200	0.45	280	X125e	X125e TO-240 	
MEA 95-06DA	600	2x 95													
MEE 95-06DA	2x 600	95													
MEK 250-12DA	1200	2x 260	75	367	2400	1.54	260	450	83	400	0.143	875	X126c	X126c Y4 	
MEA 250-12DA	1200	2x 260													
MEE 250-12DA	2x 1200	260													
MEK 300-06DA	600	2x 304	75	430	2400	1.19	260	250	66	400	0.143	875	X126c	X126c Y4 	
MEA 300-06DA	600	2x 304													
MEE 300-06DA	2x 600	304													
MEK 350-02DA	200	2x 356	75	503	2400	0.92	260	150	15	200	0.143	875	X126d	X126d Y4 	
HiPerFRED™															
MEK 150-04DA	400	2x 150	100	200	1200	1.40*	300	300	11	100	0.35	360	X125e		
MEK 600-04DA	400	2x 575	80	800	3000	1.10	400	220	80	900	0.11	1100	X126c		
MPK 95-06DA	600	2x 95	110	200	1200	1.40	100	35	5.5	100	0.575	215	X125e		

* $T_{VJM} = 150^\circ\text{C}$

Diode connections for Fig. X125 (TO-240)

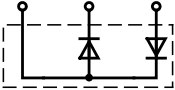

MEE

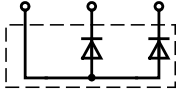

MEA

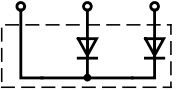

MEK / MPK

Diode connections for Fig. X126 (Y4: 34 mm package)

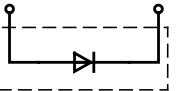

MEO

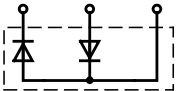

MEE

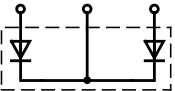

MEK

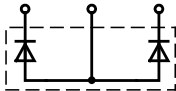

MEA

SemiFast Diodes

$I_{FAV} = 60 \text{ A}$

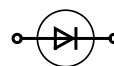





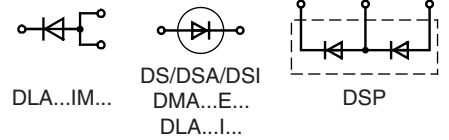

DSDI...

Type	V_{RRM}	I_{FAV}	@ T_C	I_{FRMS}	I_{FSM}	V_F	@ I_F	t_{rr}	I_{RM}	$-di/dt$	R_{thJC}	Fig. No.	Package style
	V	A	°C	A	A	V	A	ns	A	A/ μ s	K/W		
DSDI 60-14A	1400	63	60	100	500	4.1	70	300	60	500	0.4	X014b	X014b TO-247AD 
DSDI 60-16A	1600												
DSDI 60-18A	1800												

Rectifier Diodes

$I_{FAV} = 2 - 40 \text{ A}$,
Standard & Avalanche Rectifier



Type	V_{RRM}	I_{FAV}	@ T_C	P_{RSM}	I_{FRMS}	I_{FSM}	V_{F0}	r_F	T_{VJM}	R_{thJC}	R_{thCH}	Fig. No.	Package style
➤ New	V	A	°C	kW	A	A	V	mΩ	°C	K/W	K/W		Outline drawings on pages O-31...O-52
DSA 1-12D DSA 1-16D DSA 1-18D	1200 1600 1800	2.3	T_{amb} 45	1.6	7	110	0.80	67.0	150	R_{thJA} 80		X201	X004 TO-252AA 
DLA 5P800UC	2x 800	5	140	-	20	40	0.74	44.0	175	5.50	0.50	X004	
DSP 8-08S DSP 8-12S DSP 8-08A DSP 8-12A DSP 8-08AS DSP 8-12AS	2x 800 2x 1200 2x 800 2x 1200 2x 800 2x 1200	8	160	-	25	100	0.79	33.0	175	1.50	0.25	X011b X005a X011a	X005a TO-220AB 
DSP 8-12AC	2x 1200	11	100	-	17	100	0.80	41.0	150	1.80	0.60	X010a	
DLA 10IM800UC	800	10	100	-	20	80	0.80	22.0	175	3.15	0.50	X004	
DMA 10I1600PA	1600	10	150	-	25	120	0.82	37.0	175	1.50	0.50	X005b	
DMA 10P1600PZ	1600	10	150	-	25	120	0.82	37.0	175	1.50	0.50	X011c	X005b TO-220AC 
➤ DMA 10P1800PZ	2x 1600	10	150	-	25	120	0.82	37.0	175	1.50	0.25		
DLA 20IM800PC	800	20	100	-	35	200	0.80	19.0	175	1.80	0.25	X011b	
DSP 25-12A DSP 25-16A DSP 25-12AT DSP 25-16AT	2x 1200 2x 1600 2x 1200 2x 1600	25	135	-	70	300	0.81	13.8	175	0.90	0.25	X014a X019	
DSP 25-16AR	2x 1600	25	110	-	70	300	0.81	13.8	175	1.50	0.25	X016a	X010a ISOPLUS220™ 
DSI 30-08A DSI 30-12A DSI 30-16A	800 1200 1600	30	130	-	35	300	0.82	14.9	175	0.90	0.50	X005b	
DSI 30-08AS DSI 30-12AS DSI 30-16AS	800 1200 1600									0.25		X011b	
DSI 30-08AC	800	30	95	-	35	200	0.80	15.0	150	1.10	0.60	X010b	X010b ISOPLUS220™ 
➤ DMA 30IM1600PZ	1600	30	140	-	35	300	0.82	14.1	175	0.70	0.25	X011c	
DMA 30E1800HA	1800	30	140	-	70	370	0.88	12.1	175	0.70	0.25	X014b	
➤ DMA 30P1600HR	2x 1600	30	105	-	50	300	0.82	13.5	175	1.30	0.25	X016c	
DLA 40IM800PC	800	40	130	-	35	300	0.81	8.0	175	0.80	0.25	X011b	

X011c **TO-263ABHV**



X011b **TO-263AB**



X011a **TO-263AA**



X016a **ISOPLUS247™**



X014b **TO-247AD**



X014a **TO-247AD**



X201



X019 **TO-268AA**







X016c **ISO247™**



Rectifier Diodes

$I_{FAV} = 45 - 150 \text{ A}$,
Standard & Avalanche Rectifier



Type	V_{RRM}	I_{FAV}	@ T_C	P_{RSM}	I_{FRMS}	I_{FSM} 10 ms 45°C	V_{FO}	r_F	T_{VJM}	R_{thJC}	R_{thCH}	Fig. No.	Package style		
➤ New	V	A	°C	kW	A	A	V	mΩ	°C	K/W	K/W		Outline drawings on pages O-31...O-52		
DSI 45-08A	800	45	130	-	70	480	0.81	9.1	175	0.55	0.25	X014b	X005b TO-220AC 		
DSI 45-12A	1200														
DSI 45-16A	1600														
DSI 45-16AR	1600	45	100	-	70	475	0.81	9.1	175	0.90	0.20	X016b	X008b TO-262AA (I²-PAK) 		
DSIK 45-16AR	1600	2x 45	100	-	70	475	0.81	9.1	175	0.90	0.20	X016a			
DSP 45-12A	2x 1200	45	130	-	70	480	0.81	9.1	175	0.55	0.25	X014a	X011c TO-263ABHV 		
DSP 45-12AZ											0.15	X019a			
DSP 45-16A											0.25	X014a			
DSP 45-16AZ											0.15	X019a			
DSP 45-16AR	2x 1600	45	100	-	70	480	0.81	9.1	175	0.90	0.25	X016a			
➤ DSP 45-18A	2x 1800	45	130	-	70	480	0.81	9.1	175	0.55	0.25	X014a			
➤ DMA 50P1200HR	2x 1200	50	105	-	70	500	0.82	9.0	175	0.70	0.25	X016c			
DLA 60I1200HA	1200	60	150	-	70	850	0.77	4.2	175	0.30	0.25	X014b	X011c TO-263ABHV		
DSI 2x55-12A	1200	2x 60	95	-	120	800	0.83	6.2	150	0.60	0.10	X027a	X014a TO-247AD 		
DSI 2x55-16A	1600														
DMA 150E1600NA	1600	150	90	-	150	3000	0.83	2.0	150	0.25	0.10	X027a			
DNA 30ER2200IY	2200	30	140	-	35	370	0.88	12.9	175	0.70	0.50	X008b	X014a TO-247AD		
DNA 30E2200PA												X005b			
DNA 30E2200PZ												0.25		X011c	
DNA 30EM2200PZ															
DNA 30E2200FE	2200	30	100	-	70	370	0.88	12.2	175	1.35	0.20	X024e			
➤ DAA 10EM1800PZ	1800	10	150	1.6	35	150	0.81	32.0	175	1.50	0.25	X011c	X014b TO-247AD 		
➤ DAA 10P1800PZ	2x 1800	10	150	1.6	35	150	0.82	37.0	175	1.50	0.25				
➤ DMA 200X1600NA	1600	2x 100	100	-	150	1500	0.80	4.0	150	0.30	0.10	X027a	X014b TO-247AD		
➤ DMA 200XA1600NA															
➤ DAA 200X1800NA														1800	20
➤ DAA 200XA1800NA															

X016c

ISO247™



X016b

ISOPLUS247™



X016a

ISOPLUS247™



X027a

**SOT-227B
miniBLOC**



X024e **ISOPLUS i4-PAC™**

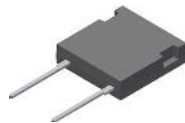

X019a







TO-268AAHV

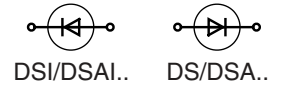

Rectifier Diodes

$I_{FAV} = 3 - 110 \text{ A}$, Standard Diodes (DS..), Avalanche Diodes (DSA..)



Type	V_{RRM}	I_{FAV}	@ T_C	P_{RSM}	I_{FRMS}	I_{FSM} 10 ms 45°C	V_{FO}	r_F	T_{VJM}	R_{thJC}	R_{thCH}	Symbol	Fig. No.	Package style					
➤ New	V	A	°C	kW	A	A	V	mΩ	°C	K/W	K/W			Outline drawings on pages O-31...O-52					
DS 2-08A DS 2-12A	800 1200	3.6	T_{amb} 45	-	7	120	0.85	43.0	180	R_{thJA} 30		X200	X200	Metal-can 					
DSA 2-12A DSA 2-16A DSA 2-18A	1200 1600 1800			2.5	7	120	0.85	43.0	180										
DSA 9-12F DSA 9-16F DSA 9-18F	1200 1600 1800			11	100	4.5	18	250	0.85		15.0				180	2.00	1.00	X204	X204 DO-203AA (DO-4) M5 
DS 17-08A DS 17-12A	800 1200			25	125	-	40	370	0.85		8.0				180	1.50	0.60		
DSA 17-12A DSA 17-16A DSA 17-18A	1200 1600 1800	25	125																
DSI 17-08A DSI 17-12A	800 1200	25	125	-	40	370	0.85	8.0	180	1.50	0.60	X205	X205 DO-203AA (DO-4) 10-32 UNF 						
DSAI 17-12A DSAI 17-16A DSAI 17-18A	1200 1600 1800	25	100	7	40	370	0.85	8.0	180	1.50	0.60								
DS 35-08A DS 35-12A	800 1200	49	100	-	80	650	0.85	4.5	180	1.05	0.20			X206a	X206a DO-203AB (DO-5) 				
DSA 35-12A DSA 35-16A DSA 35-18A	1200 1600 1800	49	100	11	80	650	0.85	4.5	180	1.05	0.20								
DSI 35-08A DSI 35-12A	800 1200	49	100	-	80	650	0.85	4.5	180	1.05	0.20	X206a	X206a DO-203AB (DO-5) 						
DSAI 35-12A DSAI 35-16A DSAI 35-18A	1200 1600 1800	49	100	11	80	650	0.85	4.5	180	1.05	0.20								
DS 75-08B DS 75-12B	800 1200	110	100	-	160	1400	0.75	2.0	180	0.50	0.40			X207	X207 DO-203AB (DO-5) 				
DSA 75-12B DSA 75-16B DSA 75-18B	1200 1600 1800	110	100	20	160	1400	0.75	2.0	180	0.50	0.40								
DSI 75-08B DSI 75-12B	800 1200	110	100	-	160	1400	0.75	2.0	180	0.50	0.40	X209	X209 TO-208AC (TO-48) 						
DSAI 75-12B DSAI 75-16B DSAI 75-18B	1200 1600 1800	110	100	20	160	1400	0.75	2.0	180	0.50	0.40								

Phase Control Thyristors

$I_{TAV} = 25 - 63 \text{ A}$



Type	V_{RRM} V_{DRM}	I_{TAV} $T_C = 85^\circ\text{C}$	$I_{T(RMS)}$	I_{TSM} 45°C 10 ms	$(dv/dt)_{cr}$	V_{TO}	r_T	T_{VJM}	R_{thJC}	R_{thCH}	Fig. No.
	V	A	A	A	V/μs	V	mΩ	°C	K/W	K/W	
CS 23-08io2 CS 23-12io2 CS 23-16io2	800 1200 1600	25	50	450	1000	1.00	10.0	125	1.00	0.60	X209
CS 35-08io4 CS 35-12io4 CS 35-14io4	800 1200 1400	63	120	1200	1000	0.85	3.5	125	0.40	0.20	X210

Data according to IEC 60747 and refer to a single diode or thyristor unless otherwise stated.

Phase Control Thyristors

Thyristors are very rugged devices. Compared to all other controlled semiconductor components, they feature the highest current capacity per chip area especially at high voltage. They are mainly used as control devices in 50 and 60 Hz AC mains equipment.

Principal applications are static converter circuits for speed control of DC-drives, or switching and control functions for temperature, lighting, soft-start, etc. in single-phase and three-phase AC switch configurations. Phase control thyristors are designed for optimal forward conduction and reverse blocking characteristics, due to only moderate requirements for turn-on and turn-off parameters.

Phase Control Thyristors





$$I_{TAV} = 5 - 30 \text{ A}$$



CLB...



CS.../CL/MA...E/I...

Type	V _{RRM} V _{DRM}	I _{TAV}	@ T _C	I _{T(RMS)}	I _{TSM} 45°C 10 ms	(dv/dt) _{cr}	V _{TO}	r _T	T _{VJM}	R _{thJC}	R _{thCH}	Fig. No.	Package style
➤ New	V	A	°C	A	A	V/μs	V	mΩ	°C	K/W	K/W		Outline drawings on pages O-31...O-52
CLA 5E1200UC ➤ CLA 5E1200PZ	1200	5	135	8	70	500	0.89	85.0	150	1.50	0.50	X004 X011c	X004 TO-252AA 
CS 19-08ho1 CS 19-12ho1 CS 19-08ho1S CS 19-12ho1S	800 1200 800 1200	20	110	31	160	500	0.86	22.0	125	0.70	0.50	X005a X011b	
➤ CMA 20E1600PB ➤ CMA 20E1600PZ	1600	20	115	31	180	500	0.92	28.0	150		0.50	X005a X011c	X005a TO-220AB 
CS 20-12io1 CS 20-14io1 CS 20-16io1	1200 1400 1600	20	130	31	260	1000	0.87	17.3	150	0.60	0.25	X014a	
CS 20-22moF1 CS 20-25mo1F	2200 2500	18	85	28	200	2500	0.97	17.0	125	0.92	0.15	X024c	
CS 20-25moT1	2500	18	85	28	200	2500	0.97	17.0	125	0.80	0.15	X019	X007a TO-220ABFP 
CS 22-08io1M CS 22-12io1M	800 1200	16	90	25	300	500	0.86	13.2	150	2.50	0.50	X007a	
CLA 30E1200PB CLA 30E1200PC ➤ CLA 30E1200NPZ ➤ CLB 30I1200PZ *	1200	30	115	47	300	500	0.86	13.2	150	0.50	0.50	X005a X011b X011c	
CLA 30E1200HB CLB 30I1200HB *	1200	30	120	47	300	500	0.86	12.5	150	0.50	0.25	X014a	X011b TO-263AB 
CMA 30E1600PB CMA 30E1600PZ CMA 30E1600PN	1600 1600 1600	30 30 30	115 115 40	47 47 47	260 260 260	500 500 500	0.92 0.92 0.92	18.0 18.0 18.0	150 150 150	0.75 0.75 2.50	0.50 0.25 0.50	X005a X011c X007a	
CS 30-12io1 CS 30-14io1 CS 30-16io1	1200 1400 1600	30	120	47	400	1000	0.87	14.2	150	0.50	0.25	X014a	

* Anode gated

X024c **ISOPLUS i4-PAC™**

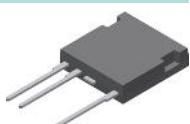

X019

TO-268AA



X014a

TO-247AD



X011c





TO-263ABHV

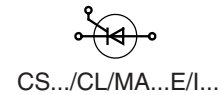

Phase Control Thyristors

$I_{TAV} = 30 - 100 \text{ A}$



Type	V_{RRM} V_{DRM}	I_{TAV}	@ T_C	$I_{T(RMS)}$	I_{TSM} 45°C 10 ms	$(dv/dt)_{cr}$	V_{TO}	r_T	T_{VJM}	R_{thJC}	R_{thCH}	Fig. No.	Package style
➤ New	V	A	°C	A	A	V/μs	V	mΩ	°C	K/W	K/W		Outline drawings on pages O-31...O-52
➤ CMA 30P1600FC	2x 1600	30	90	47	400	1000	0.87	14.2	150	1.00	0.25	X024a	X005a TO-220AB 
➤ CLA 40E1200HR	1200	40	95	63	650	1000	0.85	7.9	150	0.80	0.25	X016c	
CLA 40P1200FC	1200	40	95	63	650	1000	0.86	7.9	150	0.80	0.20	X024a	
➤ CMA 40E1600HR	1600	40	90	63	550	1000	0.81	9.8	150	0.80	0.25	X016c	
CS 45-08io1	800	45	110	71	520	1000	0.88	11.0	150	0.40	0.25	X014a	X011b TO-263AB 
CS 45-12io1	1200												
CS 45-16io1	1600												
CS 45-16io1R	1600	45	80	71	520	1000	0.88	11.0	150	0.80	0.25	X016a	
CLA 50E1200HB	1200	50	125	79	650	1000	0.88	7.7	150	0.25	0.25	X014a	X011c TO-263ABHV 
CLA 50E1200TC											0.15	X019	
➤ CMA 50E1600HB	1600	50	110	79	550	1000	0.83	9.6	150	0.40	0.25	X014a	
➤ CMA 50E1600QB												X017a	
CMA 50E1600TZ											0.15	X019a	
CMA 50P1600FC	2x 1600	50	90	79	720	1000	0.88	6.7	150	0.70	0.20	X024a	X015a 
CS 60-12io1	1200	60	110	75	1400	1000	0.82	5.3	140	0.32	0.15	X015a	
CS 60-14io1	1400												
CS 60-16io1	1600												
CLA 80E1200HF	1200	80	115	126	900	1000	0.88	6.3	150	0.20	0.25	X014a	X014a TO-247AD 
CMA 80E1600HB	1600	80	115	126	720	1000	0.90	6.4			X014a		
➤ CLA 100E1200HB	1200	100	105	160	1100	1000	0.82	5.2	150	0.20	0.15	X020a	
➤ CLA 100E1200KB													

Fast Phase Control Thyristors

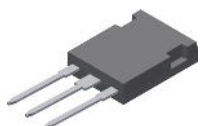
➤ CLE 20E1200PC	1200	20	115	31	160	500	0.92	24	150	0.70	0.25	X011b	X015a PLUS247 
➤ CME 30E1600PZ	1600	30	105	47	280	500	0.96	25	150	0.50	0.25	X011c	
➤ CLF 20E1200PB	1200	20	110	31	150	500	0.96	26	150	0.70	0.50	X005a	
➤ CLE 30E1200PB	1200	30	115	47	270	500	0.92	14	150	0.50	0.50		

X019 **TO-268AA**



X017a **TO-3P**



X016c **ISO247™**



X016a **ISOPLUS247™**

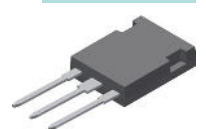

X019a **TO-268AAHV**



X020a **TO-264**



X024a **ISOPLUS i4-PAC™**

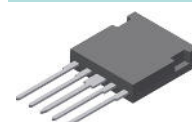

One of the essential advantages of power semiconductor modules compared to discrete designs is the electrical isolation between the baseplate of the module and the parts subject to voltage (3.6 - 4.8 kV_{RMS} tested). This makes possible the mount-down of any number of the same or different modules on a common heatsink. It is feasible to use standard housings with appropriate accessories for designing compact power converter operating from AC mains up to 690 V.

Plastic Housing with DCB Substrate

IXYS has succeeded in simplifying the conventional multilayer module construction by the DCB (Direct Copper Bonding) technique.

Other features are:

- top-side electrical terminals with captured nuts;
- series-connected diode/diode, thyristor/ diode and thyristor/thyristor modules;
- easy assembly.

All thyristor modules with DCB ceramic base contacts are available in volume with two standardized twin

plugs (2.8 mm x 0.8 mm) for gate and auxiliary cathode control terminals (version 1). Modules in TO-240 housing of the version 8 are delivered with gate plugs only (without auxiliary cathode terminal; mounting screws available on request). The module housing is designed for adequate clearance and creepage distance resulting in  recognition by Underwriters Laboratories, Inc., USA for all types.

New Generation Silicon Chips

All chips are designed by applying separation diffusion processes such that the zones responsible for the surface field strength are located at the upper chip side. This results in the capability of soldering the entire chip area onto the DCB ceramic substrate without a molybdenum strain buffer, which in turn leads to good stability of the chips as well as to large area heat dissipation if a load is applied. All zones at the edges which are decisive for the blocking stability are coated with passivation glasses the coefficient of expansion of which match that of silicon. Silicon chips increasingly use planar technology with guard rings and channel stoppers to reduce electrical surface fields. This chip design supercedes the design of thyristor chips which

were fabricated with passivation masks so that modules of the new series designed with the updated state-of-the-art utilize planar passivated chips processed by separation diffusion techniques. The contact areas of the chips possess physical vapor deposited metal layers. For the user the improved properties are:

- Excellent long-term stability of blocking currents and blocking voltages,
- increased life time of the internal soldered connections,
- high power cycling capability ($\geq 50\,000$).

The thyristor/diode chips have been optimized with regard to their turn-off parameters: decreasing the carrier lifetime results in reduced stored charges QS, which in turn significantly reduces requirements for RC-snubbers for over-voltage protection. Cost reduction and improved efficiency are the benefits of these characteristics. By re-developing the silicon chips, improvements of the firing characteristics were achieved by specifying a higher „gate current not to fire“ IGD resulting in substantially less susceptibility to misfiring. This leads to greater safety of operation and higher reliability of the equipment.

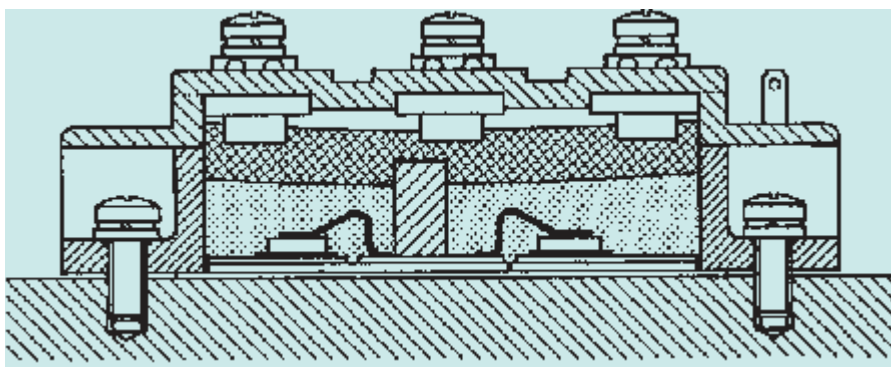
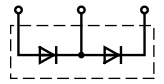

Fig. 1: Principal cross section of an IXYS module with DCB technology

Diode Modules, Dual



MDD...
MDMA..P..

$I_{FAV} = 25 - 99 \text{ A}$

Type	V_{RRM}	I_{FAV}	T_C	I_{FSM} 45°C 10 ms	V_{F0}	r_F	T_{VJM}	R_{thJC}	R_{thCH}	Fig. No.	Package style Outline drawings on pages O-31...O-52
➤ New	V	A	°C	A	V	mΩ	°C	K/W	K/W		
MDMA 25P1200TG	1200	25	100	320	0.85	11.10	150	1.10	0.20	X125e	
MDMA 25P1600TG	1600										
➤ MDMA 25P1800TG	1800										
➤ MDNA 25P2200TG	2200										
MDD 26-08N1B	800	36	100	650	0.80	6.10	150	1.00	0.20		
MDD 26-12N1B	1200										
MDD 26-14N1B	1400										
MDD 26-16N1B	1600										
MDD 26-18N1B	1800										
MDMA 35P1200TG	1200	35	100	500	0.83	7.30	150	0.90	0.20		
MDMA 35P1600TG	1600										
➤ MDMA 35P1800TG	1800										
➤ MDNA 35P2200TG	2200										
MDD 44-08N1B	800	59	100	1150	0.80	4.30	150	0.59	0.20		
MDD 44-12N1B	1200										
MDD 44-14N1B	1400										
MDD 44-16N1B	1600										
MDD 44-18N1B	1800										
MDMA 50P1200TG	1200	50	100	850	0.85	5.70	150	0.65	0.20		
MDMA 50P1600TG	1600										
➤ MDMA 50P1800TG	1800										
➤ MDNA 50P2200TG	2200										
MDD 56-08N1B	800	71	100	1400	0.80	3.00	150	0.51	0.20		
MDD 56-12N1B	1200										
MDD 56-14N1B	1400										
MDD 56-16N1B	1600										
MDD 56-18N1B	1800										
MDMA 65P1200TG	1200	65	100	1100	0.81	4.30	150	0.50	0.20		
MDMA 65P1600TG	1600										
➤ MDMA 65P1800TG	1800										
➤ MDNA 65P2200TG	2200										
MDD 72-08N1B	800	99	100	1700	0.80	2.30	150	0.35	0.20		
MDD 72-12N1B	1200										
MDD 72-14N1B	1400										
MDD 72-16N1B	1600										
MDD 72-18N1B	1800										
MDMA 85P1200TG	1200	85	100	1500	0.79	3.50	150	0.35	0.20		
MDMA 85P1600TG	1600										
➤ MDMA 85P1800TG	1800										
➤ MDNA 85P2200TG	2200										

X125e



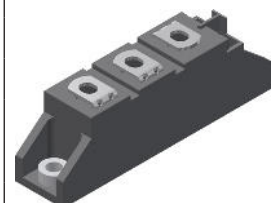



TO-240AA

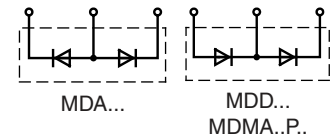

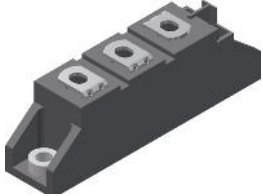
Diode Modules, Dual

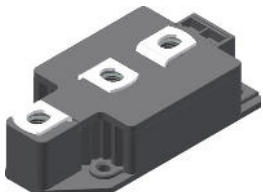
$I_{FAV} = 110 - 290 \text{ A}$

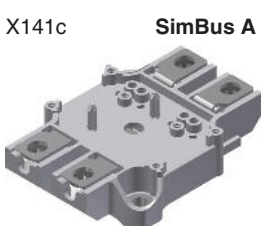

Type	V_{RRM}	I_{FAV}	T_C	I_{FSM} 45°C 10 ms	V_{F0}	r_F	T_{VJM}	R_{thJC}	R_{thCH}	Fig. No.	Package style
➤ New	V	A	°C	A	V	mΩ	°C	K/W	K/W		Outline drawings on pages O-31...O-52
MDD 95-08N1B	800	120	100	2800	0.75	1.95	150	0.260	0.20	X125e	TO-240AA 
MDD 95-12N1B	1200										
MDD 95-14N1B	1400										
MDD 95-16N1B	1600										
MDD 95-18N1B	1800										
MDD 95-20N1B	2000										
MDD 95-22N1B	2200										
MDA 95-22N1B	2200										
MDMA 110P1200TG	1200	110	100	2000	0.82	2.80	150	0.300	0.20	X126c	Y4 
MDMA 110P1600TG	1600										
➤ MDMA 110P1800TG	1800										
➤ MDNA 110P2200TG	2200										
MDMA 140P1200TG	1200	140	100	2800	0.78	2.20	150	0.230	0.20	X126c	Y2 
MDMA 140P1600TG	1600										
MDMA 140P1800TG	1800										
MDNA 140P2200TG	2200										
MDD 142-08N1	800	165	100	4700	0.80	1.30	150	0.210	0.10	X126c	Y1 
MDD 142-12N1	1200										
MDD 142-14N1	1400										
MDD 142-16N1	1600										
MDD 142-18N1	1800										
MDD 172-08N1	800	190	100	6600	0.80	0.80	150	0.210	0.10	X131c	Y1 
MDD 172-12N1	1200										
MDD 172-14N1	1400										
MDD 172-16N1	1600										
MDD 172-18N1	1800										
MDD 200-14N1	1400	224	100	10500	0.80	0.60	150	0.130	0.10	X131c	
MDD 200-16N1	1600										
MDD 200-18N1	1800										
MDD 200-22N1	2200										
MDD 175-28N1	2800	240	100	8500	0.74	1.27	150	0.140	0.04	X131c	
MDD 175-34N1	3400										
MDMA 200P1600SA	1600	200	110	6000	0.76	1.40	150	0.150	0.08	X141c	
MDD 220-08N1	800	270	100	8500	0.75	0.90	150	0.129	0.04	X129c	SimBus A 
MDD 220-12N1	1200										
MDD 220-14N1	1400										
MDD 220-16N1	1600										
MDD 220-18N1	1800										
MDD 250-08N1	800	290	100	11000	0.75	0.75	150	0.129	0.04		
MDD 250-12N1	1200										
MDD 250-14N1	1400										
MDD 250-16N1	1600										

Diode Modules, Single and Dual

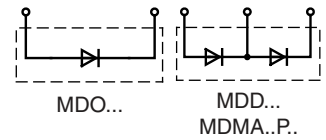

$$I_{FAV} = 270 - 700 \text{ A}$$

Type	V_{RRM}	I_{FAV}	T_C	I_{FSM} 45°C 10 ms	V_{F0}	r_F	T_{VJM}	R_{thJC}	R_{thCH}	Fig. No.	Package style Outline drawings on pages O-31...O-52
➤ New	V	A	°C	A	V	mΩ	°C	K/W	K/W		
MDD 255-12N1	1200	270	100	9500	0.80	0.60	150	0.140	0.04	X131c	
MDD 255-14N1	1400										
MDD 255-16N1	1600										
MDD 255-18N1	1800										
MDD 255-20N1	2000										
MDD 255-22N1	2200										
MDD 310-08N1	800	305	100	11500	0.75	0.63	150	0.129	0.04	X129c	
MDD 310-12N1	1200										
MDD 310-14N1	1400										
MDD 310-16N1	1600										
MDD 310-18N1	1800										
MDD 310-20N1	2000										
MDD 310-22N1	2200										
MDD 312-12N1	1200	310	100	10500	0.80	0.60	150	0.120	0.04	X131c	
MDD 312-14N1	1400										
MDD 312-16N1	1600										
MDD 312-18N1	1800										
MDD 312-20N1	2000										
MDD 312-22N1	2200										
MDMA 380P1600KC	1600	380	100	11000	0.75	0.53	150	0.110	0.04		
➤ MDMA 380P1800KC	1800										
➤ MDNA 380P2200KC	2200										
MDO 500-12N1	1200	560	85	15000	0.80	0.38	140	0.072	0.02	X132b	
MDO 500-14N1	1400										
MDO 500-16N1	1600										
MDO 500-18N1	1800										
MDO 500-20N1	2000										
MDO 500-22N1	2200										
MDO 600-16N1	1600	608	85	15000	0.76	0.32	140	0.072	0.02		
MDMA 700P1600CC	1600	700	100	20000	0.78	0.35	150	0.055	0.02	X142c	
➤ MDMA 700P1800CC	1800										
➤ MDNA 700P2200CC	2200										

For more single and dual diode modules with higher current, please see pages 138 - 140.

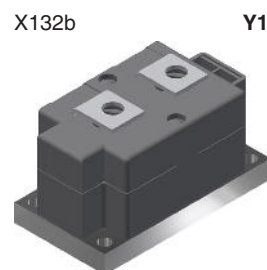

Thyristor / Diode Modules

$I_{TAV} = 25 - 80 \text{ A}$



Type	V_{RRM} V_{DRM}	I_{TAV}	T_C	$I_{T(RMS)}$	I_{TSM} 45°C 10 ms	V_{TO}	r_T	T_{VJM}	R_{thJC}	R_{thCH}	Fig. No.	Package style
➤ New	V	A	°C	A	A	V	mΩ	°C	K/W	K/W		Outline drawings on pages O-31...O-52
MCMA 25PD1200TB MCMA 25PD1600TB	1200 1600	25	82	40	400	0.87	13.0	140	1.20	0.20	X125b	 <p>SOT-227B miniBLOC</p>
MCD 26-08io1B MCD 26-12io1B MCD 26-14io1B MCD 26-16io1B	800 1200 1400 1600	27	85	50	520	0.85	11.0	125	0.88	0.20	X125d	
MCD 26-08io8B MCD 26-12io8B MCD 26-14io8B MCD 26-16io8B	800 1200 1400 1600	27	85	50	520	0.85	11.0	125	0.88	0.20	X125d	
MCMA 35PD1200TB MCMA 35PD1600TB	1200 1600	35	85	55	520	0.87	9.8	140	0.90	0.20	X125b	
MCD 40-12io6 MCD 40-16io6	1200 1600	40	85	63	500	0.87	10.5	150	0.70	0.10	X027a	
MCD 44-08io1B MCD 44-12io1B MCD 44-14io1B MCD 44-16io1B MCD 44-18io1B	800 1200 1400 1200 1600	49	85	79	1150	0.85	5.3	125	0.53	0.20	X125b	
MCD 44-08io8B MCD 44-12io8B MCD 44-14io8B MCD 44-16io8B MCD 44-18io8B	800 1200 1400 1600 1800	49	85	77	1150	0.85	5.3	125	0.53	0.20	X125d	
➤ MCNA 40PD2200TB	2200	40	85	63	500	0.84	11.4	140	0.70	0.20	X125b	
MCMA 50PD1200TB MCMA 50PD1600TB	1200 1600	50	85	79	800	0.89	5.3	140	0.70	0.20	X125b	
CLA 60PD1200NA	1200	60	100	94	1100	0.79	4.8	150	0.55	0.10	X027a	
MCD 56-08io1B MCD 56-12io1B MCD 56-14io1B MCD 56-16io1B MCD 56-18io1B	800 1200 1400 1600 1800	60	85	100	1500	0.85	3.7	125	0.45	0.20	X125b	
MCD 56-08io8B MCD 56-12io8B MCD 56-14io8B MCD 56-16io8B MCD 56-18io8B	800 1200 1400 1600 1800	60	85	100	1500	0.85	3.7	125	0.45	0.20	X125d	
➤ MCNA 55PD2200TB	2200	55	85	86	800	0.90	9.0	150	0.50	0.20	X125b	
MCMA 65PD1200TB MCMA 65PD1600TB	1200 1600	65	85	105	1150	0.85	4.8	140	0.50	0.20	X125b	
➤ MCMA 65PD1800TB	1800										X125b	
CMA 80PD1600NA	1600	80	80	126	1070	0.86	5.5	150	0.45	0.10	X027a	

Thyristor / Diode Modules

$I_{TAV} = 85 - 165 \text{ A}$

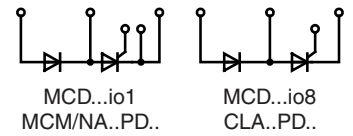

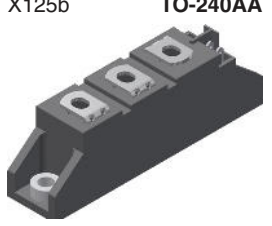
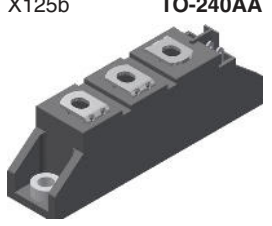
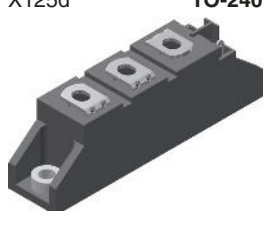
Type	V_{RRM} V_{DRM}	I_{TAV}	T_C	$I_{T(RMS)}$	I_{TSM} 45°C 10 ms	V_{T0}	r_T	T_{VJM}	R_{thJC}	R_{thCH}	Fig. No.	Package style Outline drawings on pages O-31...O-52
➤ New	V	A	°C	A	A	V	mΩ	°C	K/W	K/W		
MCD 72-08io1B	800	85	85	180	1700	0.85	3.20	125	0.30	0.20	X125b	X027a SOT-227B miniBLOC 
MCD 72-12io1B	1200											
MCD 72-14io1B	1400											
MCD 72-16io1B	1600											
MCD 72-18io1B	1800											
MCD 72-08io8B	800	85	85	180	1700	0.85	3.20	125	0.30	0.20	X125d	
MCD 72-12io8B	1200											
MCD 72-14io8B	1400											
MCD 72-16io8B	1600											
MCD 72-18io8B	1800											
➤ MCNA 75PD2200TB	2200	75	85	118	1050	0.90	6.50	140	0.38	0.20	X125b	
MCMA 85PD1200TB	1200	85	85	135	1500	0.85	3.90	140	0.38	0.20		
MCMA 85PD1600TB	1600											
➤ MCMA 85PD1800TB	1800											
CLA 100PD1200NA	1200	100	85	150	1500	0.83	3.70	150	0.35	0.10	X027a	X125b TO-240AA 
MCD 94-20io1B	2000	104	85	180	1700	0.85	3.20	125	0.22	0.20	X125b	
MCD 94-22io1B	2200											
MCD 95-08io1B	800	116	85	180	2250	0.85	2.40	125	0.22	0.20		
MCD 95-12io1B	1200											
MCD 95-14io1B	1400											
MCD 95-16io1B	1600											
MCD 95-18io1B	1800											
MCD 95-08io8B	800	116	85	180	2250	0.85	2.40	125	0.22	0.20	X125d	X125d TO-240 
MCD 95-12io8B	1200											
MCD 95-14io8B	1400											
MCD 95-16io8B	1600											
MCD 95-18io8B	1800											
➤ MCNA 95PD2200TB	2200	95	85	149	1400	0.90	5.00	140	0.30	0.20	X125b	
MCMA 110PD1200TB	1200	110	85	170	1900	0.85	3.30	140	0.30	0.20		
MCMA 110PD1600TB	1600											
➤ MCMA 110PD1800TB	1800											
MCNA 120PD2200TB	2200	120	85	190	1700	0.90	3.70	140	0.22	0.20		
MCMA 140PD1200TB	1200	140	85	200	2400	0.85	2.80	140	0.22	0.20	X125b	X126b Y4 
MCMA 140PD1600TB	1600											
➤ MCMA 140PD1800TB	1800											
MCD 132-08io1	800	130	85	300	4750	0.80	1.50	125	0.23	0.10	X126b	
MCD 132-12io1	1200											
MCD 132-14io1	1400											
MCD 132-16io1	1600											
MCD 132-18io1	1800											
MCD 161-20io1	2000	165	85	300	6000	0.80	1.60	125	0.155	0.070	X126b	
MCD 161-22io1	2200											

Thyristor / Diode Modules

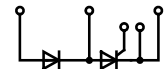

MCD...io1
MCM/NA..PD..

$I_{TAV} = 181 - 700 \text{ A}$

Type	V_{RRM} V_{DRM}	I_{TAV}	T_C	$I_{T(RMS)}$	I_{TSM} 45°C 10 ms	V_{TO}	r_T	T_{VJM}	R_{thJC}	R_{thCH}	Fig. No.	Package style
➤ New	V	A	°C	A	A	V	mΩ	°C	K/W	K/W		Outline drawings on pages O-31...O-52
MCD 162-08io1	800	181	85	300	6000	0.88	1.15	125	0.155	0.07	X126b	 <p>Y4</p>
MCD 162-12io1	1200											
MCD 162-14io1	1400											
MCD 162-16io1	1600											
MCD 162-18io1	1800											
MCMA 200PD1600SA	1600	200	85	314	6000	0.81	1.60	140	0.150	0.08	X141b	
MCD 200-14io1	1400	216	85	340	8000	0.80	1.40	125	0.130	0.05	X126b	
MCD 200-16io1	1600											
MCD 200-18io1	1800											
MCD 220-08io1	800	250	85	400	8500	0.90	1.00	140	0.139	0.04	X129b	 <p>Y2</p>
MCD 220-12io1	1200											
MCD 220-14io1	1400											
MCD 220-16io1	1600											
MCD 224-20io1	2000	240	85	400	8000	0.80	0.76	130	0.139	0.04	X131b	
MCD 224-22io1	2200											
MCD 225-12io1	1200	221	85	400	8000	0.80	0.76	130	0.157	0.04	X131b	
MCD 225-14io1	1400											
MCD 225-16io1	1600											
MCD 225-18io1	1800											
MCD 250-08io1	800	287	85	450	9000	0.85	0.82	140	0.129	0.04	X129b	 <p>Y1</p>
MCD 250-12io1	1200											
MCD 250-14io1	1400											
MCD 250-16io1	1600											
MCD 250-18io1	1800											
MCD 255-12io1	1200	250	85	450	9000	0.80	0.68	130	0.140	0.04	X131b	
MCD 255-14io1	1400											
MCD 255-16io1	1600											
MCD 255-18io1	1800											
MCMA 260PD1600YB	1600	260	85	408	8300	0.81	1.23	140	0.130	0.08	X126b	 <p>SimBus A</p>
➤ MCMA 260PD1800YB	1800											
MCMA 265PD1600KB	1600	260	85	408	8500	0.80	0.75	140	0.160	0.04	X131b	
➤ MCMA 265PD1800KB	1800											
MCD 310-08io1	800	320	85	500	9200	0.80	0.82	140	0.112	0.04	X129b	
MCD 310-12io1	1200											
MCD 310-14io1	1400											
MCD 310-16io1	1600											
MCD 310-18io1	1800											
MCD 310-20io1	2000	320	85	500	8000	0.80	0.82	140	0.112	0.04		 <p>ComPack</p>
MCD 310-22io1	2200											
MCD 312-12io1	1200	320	85	520	9200	0.80	0.68	140	0.120	0.04	X131b	
MCD 312-14io1	1400											
MCD 312-16io1	1600											
MCD 312-18io1	1800											
➤ MCNA 650PD2200CB	2200	650	85	1020	16000	0.75	0.63	140	0.045	0.02	X142a	
MCMA 700PD1600CB	1600	700	85	1100	19000	0.82	0.40	140	0.05	0.02		
➤ MCMA 700PD1800CB	1800											

For more thyristor / diode modules with higher current, please see pages 137 and 140.

Thyristor Modules, Dual

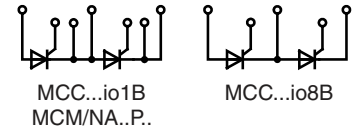

$I_{TAV} = 18 - 60 \text{ A}$

Type	V_{RRM} V_{DRM}	I_{TAV}	T_C	$I_{T(RMS)}$	I_{TSM} 45°C 10 ms	V_{TO}	r_T	T_{VJM}	R_{thJC}	R_{thCH}	Fig. No.	Package style Outline drawings on pages O-31...O-52	
➤ New	V	A	°C	A	A	V	mΩ	°C	K/W	K/W			
MCC 19-08io1B MCC 19-12io1B MCC 19-14io1B MCC 19-16io1B	800 1200 1400 1600	18	85	40	400	0.85	18	125	1.30	0.2	X125a	 <p>X125a TO-240AA</p>	
MCC 19-08io8B MCC 19-12io8B MCC 19-14io8B MCC 19-16io8B	800 1200 1400 1600	18	85	40	400	0.85	18	125	1.30	0.2	X125c		
MCC 21-08io8B MCC 21-12io8B MCC 21-14io8B MCC 21-16io8B	800 1200 1400 1600	21	85	33	320	0.85	15	125	1.10	0.2			
MCMA 25P1200TA MCMA 25P1600TA	1200 1600	25	85	40	400	0.87	13	140	1.20	0.2	X125a		
MCC 26-08io1B MCC 26-12io1B MCC 26-14io1B MCC 26-16io1B	800 1200 1400 1600	27	85	50	520	0.85	11	125	0.88	0.2			
MCC 26-08io8B MCC 26-12io8B MCC 26-14io8B MCC 26-16io8B	800 1200 1400 1600	27	85	50	520	0.85	11	125	0.88	0.2	X125c		
MCMA 35P1200TA MCMA 35P1600TA	1200 1600	35	85	55	520	0.87	9.8	140	0.90	0.2	X125a		
MCC 44-08io1B MCC 44-12io1B MCC 44-14io1B MCC 44-16io1B MCC 44-18io1B	800 1200 1400 1600 1800	49	85	77	1150	0.85	5.3	125	0.53	0.2			
MCC 44-08io8B MCC 44-12io8B MCC 44-14io8B MCC 44-16io8B MCC 44-18io8B	800 1200 1400 1600 1800	49	85	77	1150	0.85	5.3	125	0.53	0.2	X125c		
MCNA 40P2200TA	2200	40	85	63	500	0.84	11.4	140	0.70	0.2	X125a		 <p>X125c TO-240</p>
MCMA 50P1200TA MCMA 50P1600TA	1200 1600	50	85	79	800	0.89	5.3	140	0.70	0.2			
MCC 56-08io1B MCC 56-12io1B MCC 56-14io1B MCC 56-16io1B MCC 56-18io1B	800 1200 1400 1600 1800	60	85	100	1500	0.85	3.7	125	0.45	0.2			
MCC 56-08io8B MCC 56-12io8B MCC 56-14io8B MCC 56-16io8B MCC 56-18io8B	800 1200 1400 1600 1800	60	85	100	1500	0.85	3.7	125	0.45	0.2	X125c		

Thyristor Modules, Dual

$I_{TAV} = 55 - 181 \text{ A}$

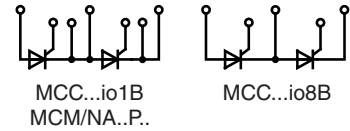

Type	V_{RRM} V_{DRM}	I_{TAV}	T_C	$I_{T(RMS)}$	I_{TSM} 45°C 10 ms	V_{T0}	r_T	T_{VJM}	R_{thJC}	R_{thCH}	Fig. No.	Package style Outline drawings on pages O-31...O-52
➤ New	V	A	°C	A	A	V	mΩ	°C	K/W	K/W		
➤ MCNA 55P2200TA	2200	55	85	86	800	0.90	9.00	140	0.50	0.20	X125a	 <p>TO-240AA</p>
MCMA 65P1200TA	1200	65	85	105	1150	0.85	4.80	140	0.50	0.20		
MCMA 65P1600TA	1600											
➤ MCMA 65P1800TA	1800											
MCC 72-08io1B	800	85	85	180	1700	0.85	3.20	125	0.30	0.20		
MCC 72-12io1B	1200											
MCC 72-14io1B	1400											
MCC 72-16io1B	1600											
MCC 72-18io1B	1800											
MCC 72-08io8B	800	85	85	180	1700	0.85	3.20	125	0.30	0.20	X125c	 <p>TO-240</p>
MCC 72-12io8B	1200											
MCC 72-14io8B	1400											
MCC 72-16io8B	1600											
MCC 72-18io8B	1800											
➤ MCNA 75P2200TA	2200	75	85	118	1050	0.90	6.50	140	0,38	0,20	X125a	
MCMA 85P1200TA	1200	85	85	135	1500	0.85	3.90	140	0.38	0.20		
MCMA 85P1600TA	1600											
➤ MCMA 85P1800TA	1800											
MCC 94-20io1B	2000	104	85	180	1700	0.85	3.20	125	0.22	0.20	X125c	
MCC 94-22io1B	2200											
MCC 94-24io1B	2400											
MCC 95-08io1B	800	116	85	180	2250	0.83	2.40	125	0.22	0.20		
MCC 95-12io1B	1200											
MCC 95-14io1B	1400											
MCC 95-16io1B	1600											
MCC 95-18io1B	1800											
MCC 95-08io8B	800	116	85	180	2250	0.85	2.40	125	0.22	0.20	X125c	
MCC 95-12io8B	1200											
MCC 95-14io8B	1400											
MCC 95-16io8B	1600											
MCC 95-18io8B	1800											
➤ MCNA 95P2200TA	2200	95	85	149	1400	0.90	5.00	140	0.30	0.20	X125a	
MCMA 110P1200TA	1200	110	85	170	1900	0.85	3.30	140	0.30	0.20		
MCMA 110P1600TA	1600											
➤ MCMA 110P1800TA	1800											
MCNA 120P2200TA	2200	120	85	190	1700	0.90	3.70	140	0.22	0.20	X126a	 <p>Y4</p>
MCMA 140P1200TA	1200	140	85	220	2400	0.85	2.80	140	0.22	0.20		
MCMA 140P1400TA	1400											
MCMA 140P1600TA	1600											
MCMA 140P1800TA	1800											
MCC 132-08io1	800	130	85	300	4750	0.80	1.50	125	0.23	0.10	X126a	
MCC 132-12io1	1200											
MCC 132-14io1	1400											
MCC 132-16io1	1600											
MCC 132-18io1	1800											
MCC 161-20io1	2000	165	85	300	6000	0.80	1.60	125	0.155	0.07		
MCC 161-22io1	2200											
MCC 162-08io1	800	181	85	300	6000	0.88	1.15	125	0.155	0.07		
MCC 162-12io1	1200											
MCC 162-14io1	1400											
MCC 162-16io1	1600											
MCC 162-18io1	1800											

Thyristor Modules, Dual

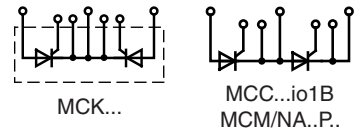

$I_{TAV} = 200 - 700 \text{ A}$

Type	V_{RRM} V_{DRM}	I_{TAV}	T_C	$I_{T(RMS)}$	I_{TSM} 45°C 10 ms	V_{TO}	r_T	T_{VJM}	R_{thJC}	R_{thCH}	Fig. No.	Package style Outline drawings on pages O-31...O-52
➤ New	V	A	°C	A	A	V	mΩ	°C	K/W	K/W		
MCMA 200P1600SA	1600	200	90	314	6000	0.81	1.60	140	0.150	0.08	X141a	X126a Y4
MCC 200-14io1	1400	216	85	340	8000	0.80	1.40	125	0.130	0.05	X126a	
MCC 200-16io1	1600											
MCC 200-18io1	1800											
MCK 200-18io1	1800	216	85	340	8000	0.80	1.40	125	0.130	0.05		
MCC 220-08io1	800	250	85	400	8500	0.90	1.00	140	0.139	0.04	X129a	X129a Y2
MCC 220-12io1	1200											
MCC 220-14io1	1400											
MCC 220-16io1	1600											
MCC 220-18io1	1800											
MCC 224-20io1	2000	240	85	400	8000	0.80	0.76	130	0.139	0.04	X131a	X129a Y2
MCC 224-22io1	2200											
MCC 224-24io1	2400											
MCC 225-12io1	1200	221	85	400	8000	0.80	0.76	130	0.157	0.04		
MCC 225-14io1	1400											
MCC 225-16io1	1600											
MCC 225-18io1	1800											
MCC 250-08io1	800	287	85	450	9000	0.85	0.82	140	0.129	0.04	X129a	X131a Y1
MCC 250-12io1	1200											
MCC 250-14io1	1400											
MCC 250-16io1	1600											
MCC 250-18io1	1800											
MCC 255-12io1	1200	250	85	450	9000	0.80	0.68	130	0.14	0.04	X131a	X131a Y1
MCC 255-14io1	1400											
MCC 255-16io1	1600											
MCC 255-18io1	1800											
MCMA 260P1600YA	1600	260	85	408	8300	0.81	1.23	140	0.13	0.08	X126a	X126a Y1
➤ MCMA 260P1800YA	1800											
MCMA 265P1600KA	1600	260	85	408	8500	0.80	0.75	140	0.16	0.04	X131a	X141a SimBus A
➤ MCMA 265P1800KA	1800											
MCC 310-08io1	800	320	85	500	9200	0.80	0.82	140	0.112	0.04	X129a	X142a ComPack
MCC 310-12io1	1200											
MCC 310-14io1	1400											
MCC 310-16io1	1600											
MCC 310-18io1	1800											
MCC 312-12io1	1200	320	85	520	9200	0.80	0.68	140	0.12	0.04	X131a	X142a ComPack
MCC 312-14io1	1400											
MCC 312-16io1	1600											
MCC 312-18io1	1800											
➤ MCNA 650P2200CA	2200	650	85	1020	16000	0.75	0.63	140	0.045	0.02	X142a	X142a ComPack
MCMA 700P1600CA	1600	700	85	1100	19000	0.82	0.40	140	0.05	0.02		
➤ MCMA 700P1800CA	1800											
➤ MCMA 700P1600NCA	1600	700	85	1200	19000	0.82	0.40	140	0.05	0.02		
➤ MCMA 700P1800NCA	1800											

For more dual thyristor modules with higher current, please see pages 136 and 140.

Thyristor Modules, Single

$I_{TAV} = 32 - 600 \text{ A}$

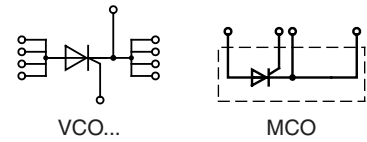

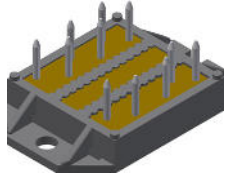
Type	V_{RRM} V_{DRM}	I_{TAV}	T_C	$I_{T(RMS)}$	I_{TSM} 45°C 10 ms	V_{T0}	r_T	T_{VJM}	R_{thJC}	R_{thCH}	Fig. No.	Package style Outline drawings on pages O-31...O-52		
➤ New	V	A	°C	A	A	V	mΩ	°C	K/W	K/W				
MCO 25-12io1 MCO 25-16io1	1200 1600	32	80	50	370	0.86	13.90	150	1.100	0.30	X027a	 <p>SOT-227B miniBLOC</p>		
MCO 50-12io1 MCO 50-16io1	1200 1600	57	80	90	740	0.88	6.00	150	0.720	0.20				
MCO 75-12io1 MCO 75-16io1	1200 1600	80	80	125	1070	0.85	5.50	150	0.450	0.10				
MCO 100-12io1 MCO 100-16io1	1200 1600	101	80	160	1400	0.85	4.50	150	0.350	0.10				
MCO 150-12io1 MCO 150-16io1	1200 1600	158	80	250	2000	0.84	3.50	150	0.200	0.10				
MCO 450-20io1 MCO 450-22io1	2000 2200	464	85	750	15000	0.77	0.42	130	0.072	0.02			X132a	
MCO 500-12io1 MCO 500-14io1 MCO 500-16io1 MCO 500-18io1	1200 1400 1600 1800	560	85	880	17000	0.80	0.38	140	0.072	0.02				
MCO 600-16io1 MCO 600-18io1 MCO 600-20io1 MCO 600-22io1	1600 1800 2000 2200	600	85	940	15000	0.81	0.40	140	0.065	0.02				
VCO 132-08io7 VCO 132-12io7 VCO 132-14io7 VCO 132-16io7 VCO 132-18io7	800 1200 1400 1600 1800	130	85	200	3600	0.80	1.65	150	0.25	0.10	X102	 <p>ECO-PAC 2</p> <p>See data sheet for pin arrangement</p>		
VCO 180-08io7 VCO 180-12io7 VCO 180-14io7 VCO 180-16io7 VCO 180-18io7	800 1200 1400 1600 1800	180	90	280	4500	0.75	1.23	150	0.17	0.06				

For more single thyristor modules with higher current, please see page 137.



Optional Accessories for Thyristor / Diode Modules

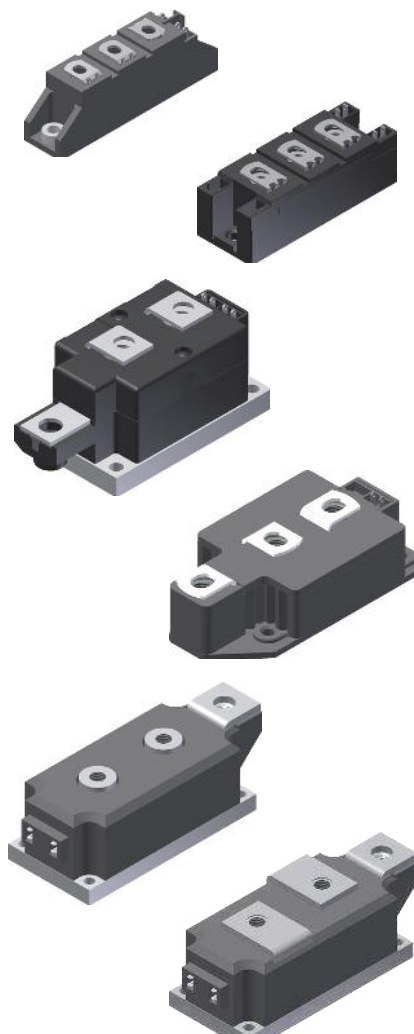

For module types MCC/MCD/MCO/MCMA 132, 161, 162, 200, 220, 224, 225, 250, 255, 260, 265, 310, 312, 500, 501, 700 and MII 400 (for MCD/MCO only L-type):
Keyed Gate Cathode twin plugs with wire length = 350 mm
gate = yellow, cathode = red

Type **ZY 180 L** (L = Left for pin pair 4/5)
Type **ZY 180 R** (R = Right for pin pair 6/7)

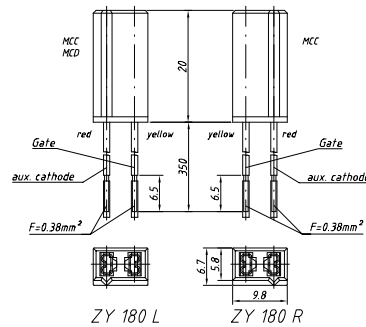

For module-types MCC/MCMA 19, 25, 26, 35, 40, 44, 50, 56, 65, 72, 85, 94, 95, 110, 120 and 140 version 1:
Keyed Gate Cathode twin plugs with wire length = 350 mm;
gate = yellow, cathode = red

Type **ZY 200 L** (L = Left for pin pair 4/5)
Type **ZY 200 R** (R = Right for pin pair 6/7)

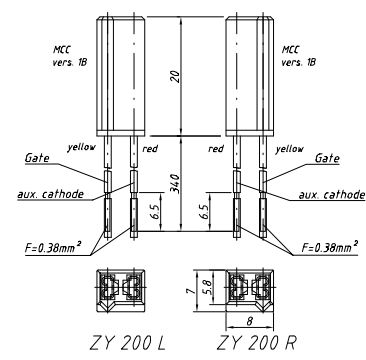

For ZY 180 and ZY 200: UL Styles 1385

For module types MCC/MCD/MDD 220, 250, 310
Threaded spacer for higher Anode / Cathode construction:

Type **ZY 250** (material brass)

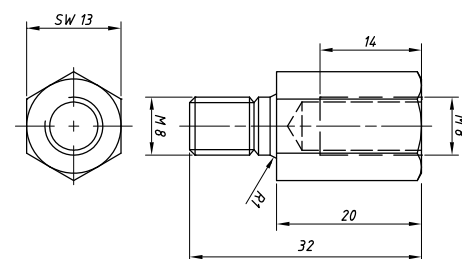

Design Information

For Thyristors, Diodes, Thyristor / Diode Modules and Rectifier Bridges

Surge current

The 60 Hz value of I_{TSM} is 10% higher than the 50 Hz value
The I_{TSM} value at T_{VJM} is 10% to 15% lower than the 45°C value

Limiting I^2t

50 Hz: $I^2t [A^2s] = I_{TSM} [A] \cdot I_{TSM} [A] \cdot 0.005 [s]$; use rated I_{TSM} value (10 ms)
60 Hz: $I^2t [A^2s] = I_{TSM} [A] \cdot I_{TSM} [A] \cdot 0.0042 [s]$; use 60-Hz-value of I_{TSM}

Forward current

The average current ratings in tables are mostly specified for temperature conditions of: $T_A = 45^\circ C$, $T_C = 85^\circ C$ or $T_C = 100^\circ C$.

For other temperature conditions the current ratings can be calculated using the following formulas applicable up to 400 Hz.

$$I_{TAV} = \frac{-V_{T0} + \sqrt{V_{T0}^2 + 4 \cdot k^2 \cdot r_T \cdot P}}{2 \cdot k^2 \cdot r_T} \quad \text{where} \quad P = \frac{T_{VJM} - T_C}{R_{thJC}} \quad \text{or} \quad P = \frac{T_{VJM} - T_A}{R_{thJA}}$$

$I_{TAV} [A]$, $P [W]$; $V_{T0} [V]$; $r_T [\Omega]$, $T_{VJM} [^\circ C]$, $T_C [^\circ C]$, $T_A [^\circ C]$, $R_{thJC} [K/W]$, $R_{thJA} [K/W]$

- $k^2 = 1$ for DC current
- $k^2 = 2.5$ for sinusoidal half wave current
- $k^2 = 3$ for 120° rectangular current
- $k^2 = 6$ for 60° rectangular current

The average forward current is limited by the RMS current value $I_{T(RMS)}$.
When the **calculated** value I_{TAV} is higher than $I_{T(RMS)} / k$, replace it by $I_{TAV} = I_{T(RMS)} / k$.

Rectifier Bridges with Fast Diodes

1-phase, B2U

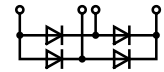

Type	V _{RRM}	I _{dAV}	@ T _C	I _{FSM} 45°C 10 ms	V _{F0}	r _F	T _{VJM}	R _{thJC}	R _{thCH}	Fig. No.	Package style
➤ New	V	A	°C	A	V	mΩ	°C	K/W	K/W		Outline drawings on pages O-31...O-52
VBE 17-06NO7	600	27	85	50	1.18	22.0	150	2.50	0.30	X101	X024a ISOPLUS i4-PAC™
VBE 17-12NO7	1200	19	85	40	1.32	30.0	150	2.50	0.30		
VBE 20-20NO1	2000	20	65	75	3.30	93.0	150	1.70	0.30	X103	X027a SOT-227B miniBLOC
VBE 26-06NO7	600	44	85	110	1.13	13.0	150	1.60	0.30	X101	
VBE 26-12NO7	1200	32	85	90	1.32	30.0	150	1.60	0.30		
VBE 55-06NO7	600	68	100	250	0.98	8.0	150	0.90	0.30		
VBE 55-12NO7	1200	59	85	200	1.31	15.0	150	0.90	0.30		
VBE 60-06A	600	60	100	250	0.98	8.2	150	1.15	0.10	X027a	
VBE 60-12A	1200	60	70	200	1.31	14.0	150	1.15	0.10		X030a SMPD-B
DHG 40B1200LB	1200	40	80	150	1.35	42	175	1.50	0.50	X030a	
DHG 50B1200LB	1200	50	80	200	1.45	26	175	1.10	0.40		
➤ DPG 60B600LB	600	60	100	250	0.85	17.0	175	1.10	0.40	X030a	X024a ECO-PAC 1
FBE 22-06N1	600	22	115	50	1.04	24.0	175	3.00	0.20	X024a	
VBE 100-06NO7	600	100	85	600	1.09	4.3	150	0.80	0.20	X102	X101 ECO-PAC 1
VBE 100-12NO7	1200	100	70	500	1.07	8.2	150	0.80	0.20		
FBS 10-06SC *	600	6.6	90	12	-	-	175	8.00	3.50	X024a	
FBS 16-06SC *	600	11	90	20	-	-	175	5.60	3.00		
FBS 10-12SC *	1200	9	80	100	-	-	175	7.00	3.50		

* SiC-Diodes

3-phase, B6U

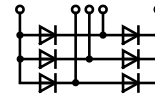

FUS 45-0045B	45	45	130	150	0.30	14.8	150	3.00	0.20	X024a	See data sheet for pin arrangement
➤ DHG 60U1200LB	1200	60	80	200	1.35	2.90	150	1.20	0.40	X030a	
VUE 50-12NO1	1200	50	85	200	1.65	18.2	150	1.20	0.30	X103	X102 ECO-PAC 2
VUE 30-20NO1	2000	30	65	75	3.30	93.0	150	1.70	0.30		
VUE 22-06NO7	600	34	85	50	1.18	22.0	150	2.50	0.30	X101	X103 V1-A-Pack
VUE 22-12NO7	1200	24	85	40	1.39	55.0	150	2.50	0.30		
VUE 35-06NO7	600	56	85	110	1.13	13.0	150	1.60	0.30		
VUE 35-12NO7	1200	40	85	90	1.32	30.0	150	1.60	0.30		
VUE 75-06NO7	600	86	100	250	0.98	8.0	150	0.90	0.30		
VUE 75-12NO7	1200	74	85	200	1.31	15.0	150	0.90	0.30		
FUE 30-12N1	1200	30	120	90	0.97	48.0	175	2.30	0.20	X024a	
VUE 130-06NO7	600	130	85	600	1.09	4.3	150	0.80	0.20	X102	
VUE 130-12NO7	1200	130	70	500	1.07	8.2	150	0.80	0.20		

Rectifier Bridges incorporating Fast Diodes

Power switching semiconductors are used in inverter systems with DC-Link. Due to high switching frequencies, harmonics and line distortion may be generated. It is important that the new designs reduce these influences and fulfill the EMI filtering requirements according to EMI/EMC VDE 0871 and other.

The noise level can be reduced by up to **10dB** when the input rectifier is equipped with semi-fast diodes and is therefore optimised for turn off; resulting in a lower peak recovery current compared to non-optimised and normal rectifier diodes.

The noise level can be further reduced approximately by another **5dB** when using rectifier bridges equipped with Fast Recovery Epitaxial Diodes (FRED) like module types VBE (single phase bridge) or VUE (three phase bridge). However these are more expensive but may be necessary in some applications to fulfill the VDE or other standards.

This behaviour has a direct influence on the design of the EMI filter networks with its capacitors and inductors of which the size and costs can be reduced.

More detailed information is available in the IXYS application note D98005E „Input Rectifiers with Semi-fast Diodes for DC Link“ on www.ixys.com.

1~ Rectifier Bridges

1~ Rectifier Bridges with Avalanche Diodes, B2U

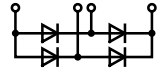

Type	V_{RRM}	V_{VRMS}	I_{dAV} @ T_C		I_{FSM} 45°C 10 ms	V_{FO}	r_F	T_{VJM}	R_{thJC}	R_{thJH}	P_{RSM}	Fig. No.	Package style Outline drawings on pages O-31...O-52
	V	V	A	°C									
VBO 13-12AO2	1200	400	18	85	220	0.85	17.0	150	5.60	6.00	2.5	X115	X024a ISOPLUS 14-PAC™
VBO 13-16AO2	1600	500											
VBO 20-12AO2	1200	400	31	85	300	0.85	14.0	150	3.00	3.40	3.4		
VBO 20-16AO2	1600	500											
VBO 25-12AO2	1200	400	38	85	370	0.85	8.0	150	2.80	3.20	3.4		
VBO 25-16AO2	1600	500											

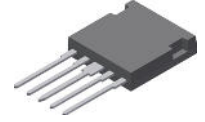

X025a

GBFP

1~ Rectifier Bridges with Standard Diodes, B2U

VBO 13-08NO2	800	250	18	85	220	0.85	17.0	150	5.60	6.00	-	X115	X027a SOT-227B miniBLOC
VBO 13-12NO2	1200	400											
VBO 13-16NO2	1600	500											
FBO 16-12N	1200	400	20	130	150	0.81	32.0	175	3.00	3.20	-	X024a	
VBO 20-08NO2	800	250	31	85	300	0.85	14.0	150	3.00	3.40	-	X115	X101 ECO-PAC 1
VBO 20-12NO2	1200	400											
VBO 20-16NO2	1600	500											
VBO 21-08NO7	800	250	20	115	120	0.84	28.8	150	2.50	2.90	-		
VBO 21-12NO7	1200	400											
VBO 22-08NO8	800	250	14	85	380	0.77	14.2	150	8.00	9.00	-	X116b	X101 ECO-PAC 1
VBO 22-12NO8	1200	400											
VBO 22-16NO8	1600	500											
VBO 22-18NO8	1800	575											
GBO 25-12NO1	1200	400	25	105	370	0.74	16.3	175	4.30	4.80	-	X025a	
GBO 25-16NO1	1600	500											
VBO 25-08NO2	800	250	38	85	370	0.85	8.0	150	2.80	3.20	-	X115	See data sheet for pin arrangement
VBO 25-12NO2	1200	400											
VBO 25-16NO2	1600	500											
VBO 30-08NO7	800	250	25	85	400	0.80	12.9	150	4.70	4.80	-	X115	X115 FO-A
VBO 30-12NO7	1200	400											
VBO 30-16NO7	1600	500											
VBO 30-18NO7	1800	575											
VBO 36-08NO8	800	250	18	85	550	0.76	9.1	150	7.00	8.00	-	X116b	X116b FO-B
VBO 36-12NO8	1200	400											
VBO 36-16NO8	1600	500											
VBO 36-18NO8	1800	575											
FBO 40-12N	1200	400	40	130	300	0.79	14.0	175	1.50	1.70	-	X024a	
VBO 40-08NO6	800	250	40	115	320	0.81	12.1	150	1.30	1.40	-	X027a	X119b PWS-A
VBO 40-12NO6	1200	400											
VBO 40-16NO6	1600	500											
VBO 50-08NO7	800	250	45	85	750	0.76	6.9	150	2.70	3.10	-	X120b	X120b PWS-B
VBO 50-12NO7	1200	400											
VBO 50-16NO7	1600	500											
VBO 50-18NO7	1800	575											
VBO 52-08NO7	800	250	60	115	550	0.78	8.1	150	1.10	1.50	-	X122b	X122b PWS-D
VBO 52-12NO7	1200	400											
VBO 52-16NO7	1600	500											
VBO 52-18NO7	1800	575											
VBO 54-08NO7	800	250	55	105	300	0.82	12.2	150	1.10	1.50	-	X101	X101
VBO 54-12NO7	1200	400											
VBO 54-16NO7	1600	500											
VBO 68-08NO7	800	250	70	105	550	0.81	7.8	150	0.90	1.30	-	X101	X101
VBO 68-12NO7	1200	400											
VBO 68-16NO7	1600	500											
VBO 72-08NO7	800	250	70	110	750	0.78	6.0	150	0.90	1.30	-	X122b	X122b
VBO 72-12NO7	1200	400											
VBO 72-16NO7	1600	500											
VBO 72-18NO7	1800	575											

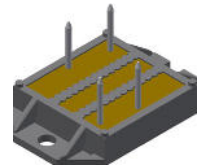

See data sheet for pin arrangement

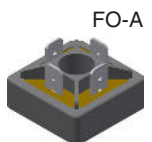

X115

FO-A

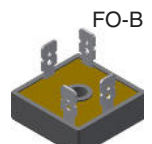

X116b

FO-B

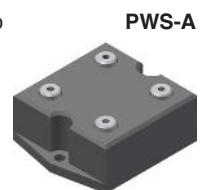

X119b

PWS-A

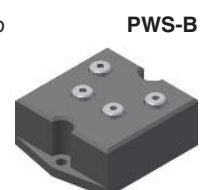

X120b

PWS-B



X122b

PWS-D

1~ Rectifier Bridges

1~ Rectifier Bridges with Standard Diodes, B2U

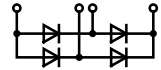

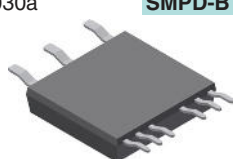
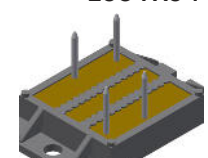
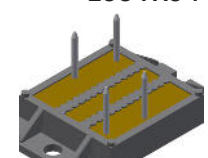
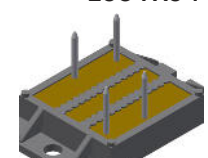
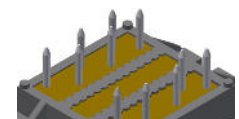
Type	V _{RRM}	V _{VRMS}	I _{dAV}	@ T _C	I _{FSM} 45°C 10 ms	V _{F0}	r _F	T _{VJM}	R _{thJC}	R _{thJH}	Fig. No.	Package style
➤ New	V	V	A	°C	A	V	mΩ	°C	K/W	K/W		Outline drawings on pages O-31...O-52
VBO 78-08NO7	800	250	80	115	750	0.81	5.9	150	0.70	1.00	X102	X030a SMPD-B 
VBO 78-12NO7	1200	400										
VBO 78-16NO7	1600	500										
VBO 88-08NO7	800	250	90	115	1000	0.80	4.6	150	0.60	0.90	X101	ECO-PAC 1 
VBO 88-12NO7	1200	400										
VBO 88-16NO7	1600	500										
➤ DLA 100B800LB	800	400	124	80	400	0.75	4.2	175	1.00	1.45	X030a	
➤ DLA 100B1200LB	1200											
VBO 105-08NO7	800	250	100	100	1500	0.78	4.8	150	0.80	1.10	X121b	ECO-PAC 1 
VBO 105-12NO7	1200	400										
VBO 105-16NO7	1600	500										
VBO 125-08NO7	800	250	125	105	1800	0.76	3.6	150	0.60	0.90	X123e	 See data sheet for pin arrangement
VBO 125-12NO7	1200	400										
VBO 125-16NO7	1600	500										
VBO 130-08NO7	800	250	130	110	1800	0.77	3.4	150	0.50	0.70	X123e	See data sheet for pin arrangement
VBO 130-12NO7	1200	400										
VBO 130-16NO7	1600	500										
VBO 130-18NO7	1800	575										
VBO 160-08NO7	800	250	160	110	2800	0.74	2.4	150	0.40	0.55	X102	ECO-PAC 2  See data sheet for pin arrangement
VBO 160-12NO7	1200	400										
VBO 160-16NO7	1600	500										
VBO 160-18NO7	1800	575										

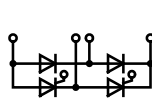

VGO

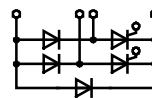



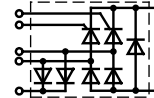

VHF

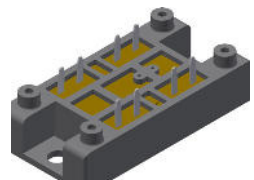
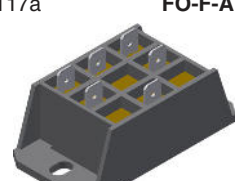
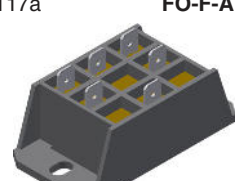

VHFD

Type	V _{RRM}	V _{VRMS}	I _{dAV}	@ T _H	I _{TSM} 10 ms, 45°C	V _{T0}	r _T	T _{VJM}	R _{thJC}	R _{thJH}	Fig. No.
	V	V	A	°C	A	V	mΩ	°C	K/W	K/W	

1~ Half Controlled Rectifier Bridges with free wheeling diode, B2HKF

VHF 15-08io5	800	250	15	85	190	1.00	40.0	125	2.40	3.00	X117a	
VHF 15-12io5	1200	400										
VHF 15-14io5	1400	440										
VHF 15-16io5	1600	500										
VHF 25-08io7	800	250	32	T _C = 85°C	200	0.85	27.0	125	1.30	1.80	X101	
VHF 25-12io7	1200	400										
VHF 28-08io5	800	250	28	85	300	0.90	15.0	125	1.40	2.00	X117a	
VHF 28-12io5	1200	400										
VHF 28-14io5	1400	440										
VHF 28-16io5	1600	500										
VHF 36-08io5	800	250	36	85	320	0.85	13.0	125	1.15	1.55	X121b	PWS-C 
VHF 36-12io5	1200	400										
VHF 36-14io5	1400	440										
VHF 36-16io5	1600	500										
VHFD 16-08io1	800	250	16	85	150	1.00	40.0	125	2.40	3.00	X103	
VHFD 16-12io1	1200	400										
VHFD 16-16io1	1600	500										
VHFD 29-08io1	800	250	28	85	300	0.90	15.0	125	1.40	2.00	X123e	PWS-E 
VHFD 29-12io1	1200	400										
VHFD 29-16io1	1600	500										
VHFD 37-08io1	800	250	36	85	320	0.85	13.0	125	1.20	1.55	X101	
VHFD 37-12io1	1200	400										
VHFD 37-16io1	1600	500										

1~ Half Controlled Rectifier Bridge, B2HZ

VGO 36-16io7	1600	500	36	85	320	0.85	13.0	125	1.40	2.00	X101
--------------	------	-----	----	----	-----	------	------	-----	------	------	------

3~ Rectifier Bridges

3~ Rectifier Bridges with Standard Diodes, B6U

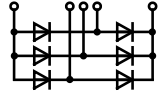

Type	V _{RRM}	V _{VRMS}	I _{dAV}	@ T _C	I _{FSM} 45°C 10 ms	V _{F0}	r _F	T _{VJM}	R _{thJC}	R _{thJH}	Fig. No.	Package style
○ Not for new design ➤ New	V	V	A	°C	A	V	mΩ	°C	K/W	K/W		Outline drawings on pages O-31...O-52
FUO 22-12N FUO 22-16N	1200 1600	400 500	30	120	150	0.81	31.0	175	3.00	3.20	X024a	X024a ISOPLUS i4-PAC™
VUO 22-08NO1 VUO 22-12NO1 VUO 22-14NO1 VUO 22-16NO1 VUO 22-18NO1	800 1200 1400 1600 1800	250 400 440 500 575	30	110	150	0.84	28.0	150	2.50	2.90	X103	X025b GUPF
VUO 25-08NO8 VUO 25-12NO8 VUO 25-14NO8 VUO 25-16NO8 VUO 25-18NO8	800 1200 1400 1600 1800	250 400 440 500 575	20	85	380	0.77	14.2	150	8.00	9.00	X116a	X101 ECO-PAC 1
VUO 28-08NO7 VUO 28-12NO7	800 1200	250 400	30	105	120	0.84	28.8	150	2.50	2.90	X101	X116a See data sheet for pin arrangement
VUO 36-08NO8 VUO 36-12NO8 VUO 36-14NO8 VUO 36-16NO8 VUO 36-18NO8	800 1200 1400 1600 1800	250 400 440 500 575	27	85	550	0.76	9.1	150	7.00	8.00	X116a	X103 V1-A-Pack
VUO 34-08NO1 VUO 34-12NO1 VUO 34-14NO1 VUO 34-16NO1 VUO 34-18NO1	800 1200 1400 1600 1800	250 400 440 500 575	45	110	300	0.81	14.9	150	1.70	2.10	X103	X116a FO-B
VUO 30-08NO3 VUO 30-12NO3 VUO 30-14NO3 VUO 30-16NO3 VUO 30-18NO3	800 1200 1400 1600 1800	250 400 440 500 575	45	110	300	0.80	12.9	150	2.00	2.40	X117b	X117b FO-F-B
VUO 35-08NO7 VUO 35-12NO7 VUO 35-14NO7 VUO 35-16NO7 VUO 35-18NO7	800 1200 1400 1600 1800	250 400 440 500 575	35	85	400	0.80	12.9	150	4.20	4.80	X119a	X025b X119a PWS-A
GUO 40-08NO1 GUO 40-12NO1 GUO 40-16NO1 ➤ DMA 40U1800GU ➤ DNA 40U2200GU	800 1200 1600 1800 2200	250 400 500 575 690	40	90	370	0.74	16.3	175	4.30	4.80	X025b	X119a PWS-A
FUO 50-16N	1600	500	50	120	270	0.78	17	175	2.10	2.30	X024a	X103 X120a PWS-B
VUO 52-08NO1 VUO 52-12NO1 VUO 52-14NO1 VUO 52-16NO1 VUO 52-18NO1 VUO 52-20NO1 VUO 52-22NO1	800 1200 1400 1600 1800 2000 2200	250 400 440 500 575 690	60	110	350	0.83	11.5	150	1.30	1.60	X103	X117b X120a PWS-B
VUO 50-08NO3 VUO 50-12NO3 VUO 50-14NO3 VUO 50-16NO3 VUO 50-18NO3	800 1200 1400 1600 1800	250 400 440 500 575	60	110	500	0.78	8.5	150	1.50	1.90	X117b	

Data according to IEC 60747 and refer to a single diode or thyristor unless otherwise stated.

3~ Rectifier Bridges

3~ Rectifier Bridges with Standard Diodes, B6U

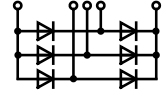

Type	V_{RRM}	V_{VRMS}	I_{dAV}	@ T_C	I_{FSM} 45°C 10 ms A	V_{F0}	r_F	T_{VJM}	R_{thJC}	R_{thJH}	Fig. No.	Package style
○ Not for new design ➤ New	V	V	A	°C	A	V	mΩ	°C	K/W	K/W		Outline drawings on pages O-31...O-52
VUO 55-12NO7	1200	400	60	85	750	0.76	6.9	150	2.70	3.10	X120a	X030a SMPD-B 
VUO 55-14NO7	1400	440										
VUO 55-16NO7	1600	500										
VUO 55-18NO7	1800	575										
VUO 60-12NO3	800	250	75	110	700	0.77	6.5	150	1.20	1.60	X117b	X101 ECO-PAC 1 
VUO 60-14NO3	1400	440										
VUO 60-16NO3	1600	500										
VUO 60-18NO3	1800	575										
VUO 62-08NO7	800	250	60	120	550	0.78	8.1	150	1.10	1.50	X122a	See data sheet for pin arrangement
VUO 62-12NO7	1200	400										X102 ECO-PAC 2 
VUO 62-14NO7	1400	440										
VUO 62-16NO7	1600	500										
VUO 62-18NO7	1800	575										
VUO 64-16NO7	1600	500	60	120	550	0.78	8.1	150	1.10	1.50	X122c	See data sheet for pin arrangement
VUO 68-08NO7	800	250	70	105	300	0.82	12.2	150	1.10	1.50	X101	X103 V1-A-Pack 
VUO 68-12NO7	1200	400										
VUO 68-14NO7	1400	440										
VUO 68-16NO7	1600	500										
○ VUO 70-16NO7	1600	500	70	100	550	0.80	8.0	150	1.45	1.90	X118d	
VUO 80-08NO1	800	250	80	110	600	0.81	7.8	150	1.10	1.40	X103	X117b FO-F-B 
VUO 80-12NO1	1200	400										
VUO 80-14NO1	1400	440										
VUO 80-16NO1	1600	500										
VUO 80-18NO1	1800	575										X118d FO-T-A 
VUO 82-08NO7	800	250	90	115	750	0.78	6.0	150	0.90	1.30	X122a	X120a PWS-B 
VUO 82-12NO7	1200	400										
VUO 82-14NO7	1400	440										
VUO 82-16NO7	1600	500										
VUO 82-18NO7	1800	575										
VUO 84-16NO7	1600	500	90	115	750	0.78	6.0	150	0.90	1.30	X122c	X121a PWS-C 
VUO 86-08NO7	600	125	90	105	550	0.81	7.8	150	0.90	1.30	X101	X122a PWS-D 
VUO 86-12NO7	1200	400										
VUO 86-14NO7	1400	440										
VUO 86-16NO7	1600	500										
➤ DMA 90U1800LB DNA 90U2200LB	1800 2200	575 690	90	110	350	0.81	12.7	175	1.10	1.50	X030a	X122a PWS-D Flat 
VUO 98-08NO7	800	250	105	115	750	0.81	5.9	150	0.70	1.00	X102	
VUO 98-12NO7	1200	400										
VUO 98-14NO7	1400	440										
VUO 98-16NO7	1600	500										
VUO 105-12NO7	1200	400	120	105	1500	0.78	4.8	150	0.80	1.10	X121a	X122c
VUO 105-14NO7	1400	440										
VUO 105-16NO7	1600	500										
VUO 105-18NO7	1800	575										

3~ Rectifier Bridges

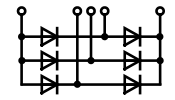

3~ Rectifier Bridges with Standard Diodes, B6U

DM/NA...YA...

DM/NA...YC...

VUO.. DM/NA..U..
MDM/NA..U..

Type	V_{RRM}	V_{VRMS}	I_{dAV}	@ T_C	I_{FSM} 45°C 10 ms	V_{F0}	r_F	T_{VJM}	R_{thJC}	R_{thJH}	Fig. No.	Package style
○ Not for new design ➤ New	V	V	A	°C	A	V	mΩ	°C	K/W	K/W		Outline drawings on pages O-31...O-52
VUO 110-08NO7 VUO 110-12NO7 VUO 110-14NO7 VUO 110-16NO7 VUO 110-18NO7	800 1200 1400 1600 1800	250 400 440 500 575	125	110	1200	0.79	4.5	150	0.70	1.00	X123c	X027a SOT-227B miniBLOC 
VUO 120-12NO2T VUO 120-16NO2T	1200 1600	400 500	180	90	1100	0.81	4.4	150	0.60	0.80	X104	
VUO 121-16NO1	1600	500	120	105	700	0.80	7.6	150	0.65	0.75	X112	
VUO 122-08NO7 VUO 122-12NO7 VUO 122-14NO7 VUO 122-16NO7	800 1200 1400 1600	250 400 440 500	125	115	1000	0.80	4.6	150	0.60	0.90	X102	X102 ECO-PAC 2 
VUO 125-12NO7 VUO 125-14NO7 VUO 125-16NO7 VUO 125-18NO7	1200 1400 1600 1800	400 440 500 575	150	110	1800	0.76	3.6	150	0.60	0.90	X121a	See data sheet for pin arrangement
➤ DNA 90YA2200NA ➤ DNA 90YC2200NA	2200	690	90	85	370	0.86	11.4	150	1.20	1.30	X027a	
DMA 150YA1600NA DMA 150YC1600NA	1600	500	150	95	700	0.82	6.3	150	0.60	0.70	X104	X104 V2-Pack 
VUO 160-08NO7 VUO 160-12NO7 VUO 160-14NO7 VUO 160-16NO7 VUO 160-18NO7	800 1200 1400 1600 1800	250 400 440 500 575	175	110	1800	0.77	3.4	150	0.50	0.70	X123c	
VUO 162-16NO7	1600	500	175	110	1800	0.77	3.4	150	0.50	0.70	X123h	X112 E2-Pack 
VUO 190-08NO7 VUO 190-12NO7 VUO 190-14NO7 VUO 190-16NO7 VUO 190-18NO7	800 1200 1400 1600 1800	250 400 440 500 575	240	110	2800	0.74	2.4	150	0.40	0.55	X123c	
VUO 192-16NO7	1600	500	240	110	2800	0.74	2.4	150	0.40	0.55	X123h	
➤ MDNA 240U2200ED	2200	690	240	90	1500	0.79	5.1	150	0.35	0.45	X112	X113 E3-Pack 
➤ MDMA 660U1600PTEH	1600	500	660	85	5000	0.77	1.8	150	0.15	0.23	X113	
➤ MDNA 660U2200PTEH	2200	690										
➤ MDMA 900U1600PTEH	1600	500	900	85	8000	0.76	1.4	150	0.10	0.15		

X123h

PWS-E Flat



X123c

PWS-E



X121a

PWS-C

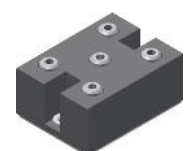

3~ Rectifier Bridges

3~ Rectifier Bridges
with IGBT and Fast Diode for Brake Unit

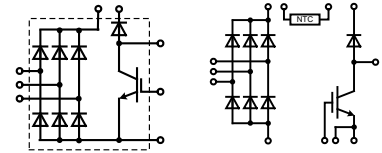

Type	Rectifier			IGBT		Fast Diode			Fig. No.	Package style Outline drawings on pages O-31...O-52
	V_{RRM} V	I_{dAV} A	@ T_C °C	V_{CES} V	I_{C80} A	V_{RRM} V	$I_{F(AV)}$ A	t_{rr} ns		
➤ New										
VUB 72-12NOXT	1200	110	75	1200	40	1200	21	130	X103	X027a SOT-227B miniBLOC
VUB 72-16NOXT	1600									
VUI 72-16NOXT	1600	110	75	1200	40	-	-	-		
VUB 116-16NOXT	1600	120	105	1200	84	1200	32	150	X112	
VUB 120-16NOX VUB 120-16NOXT	1600	180	90	1200	108	1200	32	150	X104	
VUB 135-22NO1	2200	150	105	1700	80	1700	33	tbd	X112	
VUB 145-16NOXT	1600	150	105	1200	108	1200	32	150		
VUB 160-16NOX VUB 160-16NOXT	1600	180	90	1200	150	1200	32	150	X104	
➤ MDMA 210UB1600PTED	1600	210	85	1200	84	1200	59	350	X112	
➤ MDNA 210UB2200PTED	2200	210	85	1700	100	1700	54	550		
MDMA 240UB1600ED	1600	240	85	1200	108	1200	59	350		
➤ MDMA 280UB1600PTED	1600	280	85	1200	108	1200	59	350	X104	V2-Pack
➤ MDNA 280UB2200PTED	2200	280	85	1700	100	1700	54	550		
➤ MDMA 360UB1600PTED	1600	360	85	1200	150	1200	90	350		
➤ MDNA 360UB2200PTED	2200	360	85	1700	145	1700	83	550		

3~ Half Controlled Rectifier Bridges

with IGBT and Fast Diode for Brake Unit

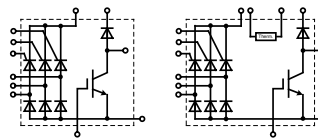

Type	Rectifier			IGBT		Fast Diode			Fig. No.	Package style
	V_{RRM} V	I_{dAV} A	@ T_C °C	V_{CES} V	I_{C80} A	V_{RRM} V	$I_{F(AV)}$ A	t_{rr} ns		
➤ New										
VVZB 120-16ioX	1600	180	85	1200	108	1200	32	150	X112	PWS-E
MCNA 120UI2200TED	2200	117	80	1700	80	1700	50	550		
VVZB 135-16ioXT	1600	150	85	1200	84	1200	32	150		
VVZB 170-16ioXT	1600	180	85	1200	108	1200	32	150		
MCMA 240UI1600ED	1600	240	80	1200	108	1200	59	350	X123h	PWS-E Flat
➤ MCMA 240UI1600PED										

3~ Rectifier Bridges

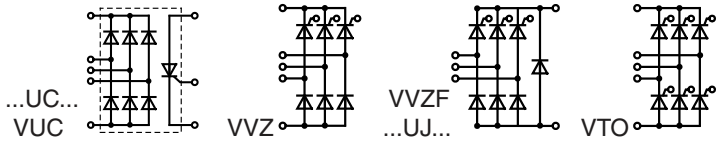

Type	V _{RRM}	V _{VRMS}	I _{dAVM}	@ T _H	I _{FSM/TSM}	V _{T0}	r _T	T _{VJM}	R _{thJC}	R _{thJH}	Fig. No.	Package style Outline drawings on pages O-31...O-52
	V	V	A	°C	10 ms, 45°C A	V	mΩ	°C	K/W	K/W		
3~ Rectifier Bridges with Fast Diodes (t_{rr} = 1.5 ms) & Integrated Softstart Thyristor												
VUC 36-12go2	1200	400	34	85	Dio.	300	1.20	16.0	125	1.40	2.00	X105a
					Thy.	400	0.85	10.0	125	0.90	1.10	
VUC 36-16go2	1600	500	34	85	Dio.	300	1.20	16.0	125	1.40	2.00	X105a
					Thy.	400	0.85	10.0	125	0.90	1.10	
MDMA 60UC1600VC	1600	500	60	110	Dio.	350	0.83	11.5	150	1.30	1.60	X105c
					Thy.	800	0.89	5.3	140	0.70	0.90	

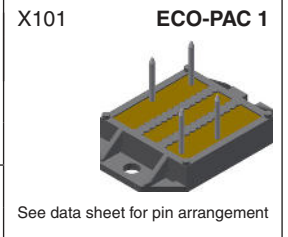

Type	V _{RRM}	V _{VRMS}	I _{dAVM}	@ T _H	I _{FSM/TSM}	V _{T0}	r _T	T _{VJM}	R _{thJC}	R _{thJH}	Fig. No.
	V	V	A	°C	10 ms, 45°C A	V	mΩ	°C	K/W	K/W	

3~ Half Controlled Rectifier Bridges, B6HK											
VVZ 39-08ho7	800	250	39	85	200	0.85	27.0	125	1.30	1.80	X101
VVZ 39-12ho7	1200	400									
VVZ 40-12io1	1200	400	34	100	320	0.85	15.0	125	1.00	1.60	X105a
VVZ 40-16io1	1600	500									
VVZ 110-12io7	1200	400	110	85	1150	0.85	6.0	125	0.65	0.80	X123b
VVZ 175-12io7	1200	400	167	85	1500	0.85	3.5	125	0.46	0.55	
VVZ 175-16io7	1600	500									

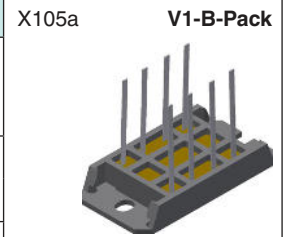

3~ Half Controlled Rectifier Bridges with free wheeling diode, B6HKF											
MCMA 120UJ1800ED	1800	575	117	80	500	0.89	13.6	150	0.65	0.75	X112
VVZF 70-16io7	1600	500	70	85	550	0.85	11.0	125	0.90	1.10	X118c

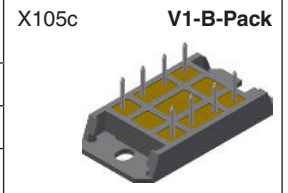

3~ Full Controlled Rectifier Bridges, B6C											
VTO 39-08ho7	800	250	39	85	200	0.85	27.0	125	1.30	1.80	X101
VTO 39-12ho7	1200	400									

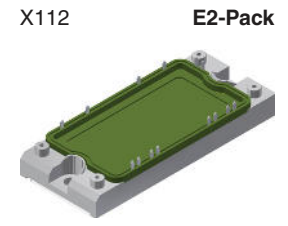
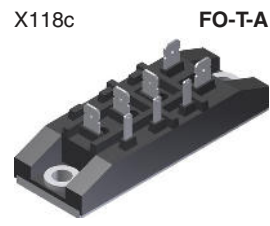
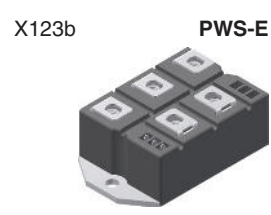

Data according to IEC 60747 and refer to a single diode or thyristor unless otherwise stated.

AC Controller 1~ / 2~ / 3~

$I_{RMS} = 30 - 230 A$

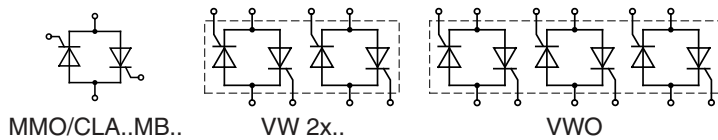

Type	V_{RRM}	V_{VRMS}	I_{RMS}	@ T_C	I_{TSM} 10 ms 45°C	V_{TO}	r_T	T_{VJM}	R_{thJC}	R_{thJH}	Fig. No.	Package style		
➤ New	V	V	A	°C	A	V	mΩ	°C	K/W	K/W		Outline drawings on pages O-31...O-52		
1~	MMO 62-12io6	1200	400	66	95	400	0.87	13.6	150	0.90	1.10	X027a	SOT-227B miniBLOC	
	MMO 62-16io6	1600	500											
	MMO 74-12io6	1200	400	88	95	600	0.87	10.5	150	0.70	0.80			
	MMO 74-16io6	1600	500											
	MMO 90-12io6	1200	400	110	95	800	0.88	6.0	150	0.60	0.70			
	MMO 90-14io6	1400	440											
	MMO 90-16io6	1600	500											
	CLA 110MB1200NA	1200	400	110	110	1100	0.78	4.9	150	0.55	0.65			
	MMO 110-08io7	800	250	112	85	1000	0.85	5.6	150	0.80	0.92	X101	ECO-PAC 1	
	MMO 110-12io7	1200	400											
	MMO 110-14io7	1400	440											
	MMO 140-08io7	800	250	130	85	1150	0.85	5.2	150	0.70	0.82		ECO-PAC 2	
MMO 140-12io7	1200	400												
MMO 140-16io7	1600	500												
MMO 175-08io7	800	250	175	85	1500	0.85	3.7	150	0.50	0.62		V1-A-Pack		
MMO 175-12io7	1200	400												
MMO 175-16io7	1600	500												
MMO 230-08io7	800	250	230	85	2250	0.80	2.4	125	0.26	0.46	X102	V2-Pack		
MMO 230-12io7	1200	400												
MMO 230-14io7	1400	440												
MMO 230-16io7	1600	500												
MMO 230-18io7	1800	575												
2~	VW 2x60-12io1	1200	400	2x 60	85	520	0.85	11.0	125	0.92	1.22	X103	V1-A-Pack	
	VW 2x60-14io1	1400	440											
	VW 2x60-16io1	1600	500											
3~	VVO 35-08ho7	800	250	3x 35	85	200	0.85	27.0	125	1.30	1.80	X101	V1-A-Pack	
	VVO 35-12ho7	1200	400											

TRIAC 1~

$I_{RMS} = 30 - 650 A$

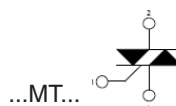

➤ CLA 30MT1200NPB	1200	400	33	120	170	0.89	30.5	150	0.95	1.45	X005a	X011c	TO-263ABHV
➤ CLA 30MT1200NPZ										1.20	X011c		
➤ CLA 40MT1200NPB	1200	400	44	110	180	0.89	27.9	150	0.80	1.30	X005a	X014a	TO-247AD
➤ CLA 40MT1200NPZ										1.05	X011c		
➤ CLA 40MT1200NHB											X014a		
➤ CLA 40MT1200NHR				95						1.30	1.55	X016c	
CLA 60MT1200NHB	1200	400	66	120	380	0.86	12.5	150	0.55	0.80	X014a	X016c	ISO247™
CLA 60MT1200NTZ										0.70	X019a		
CLA 60MT1200NHR				100						0.90	1.15	X016c	
➤ CMA 60MT1600NHB	1600	500	66	115	260	0.90	16.6	150	0.85	0.80	X014a		
➤ CMA 60MT1600NHR				90						0.90	1.15	X016c	
➤ CLA 80MT1200NHB	1200	400	88	120	480	0.85	9.2	150	0.40	0.65	X014a	X132a	Y1-2-Cu
➤ CLA 80MT1200NHR				100						0.65	0.90		
➤ MCMA 650MT1800NKD	1800	575	650	85	9200	0.82	0.67	140	0.12	0.04	X132a		

Triode - Reverse Conducting Thyristor

$I_{RMS} = 35 A$

➤ CLA 20EF1200PB	1200	400	20	115	120	0.90	25	150	0.65	1.15	X005a
------------------	------	-----	----	-----	-----	------	----	-----	------	------	-------

1~ / 3~ High Voltage Rectifier Modules

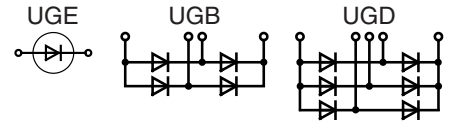

Type	V_{RRM} V	I_{dAV} ① / ② A	I_{FSM} 10 ms, 45°C A	V_{F0} V	r_F mΩ	T_{VJM} °C	R_{thJA1} ① K/W	R_{thJA2} ② K/W	Fig. No.	Package style Outline drawings on pages O-31...O-52
UGE 0421AY4	3200	23 / 7.4	300	1.70	16	150	1.9	7.1	X251	
UGE 0221AY4	4800	10 / 3.8	180	2.55	90	150	1.7	8.0		
UGE 1112AY4	8000	4.2 / 2.0	120	4.25	215	150	4.2	10.0		
UGE 3126AY4	24000	2.0 / 0.8	70	12.00	1800	150	2.7	8.7		
UGB 3132AD	4800	1.3	60	-	-	150	-	-	X252	
UGB 6124AG	10500	1.0	50	-	-	150	-	-	X253b	
UGD 6123AG	7200	1.8	50	-	-	150	-	-	X253a	
UGD 8124AG	10500	1.2	50	-	-	150	-	-		

Data according to IEC 60747-2/6

① for oil-cooling with cooling plate, $T_A = 35^\circ\text{C}$

② for natural air cooling without cooling plate, $T_A = 45^\circ\text{C}$

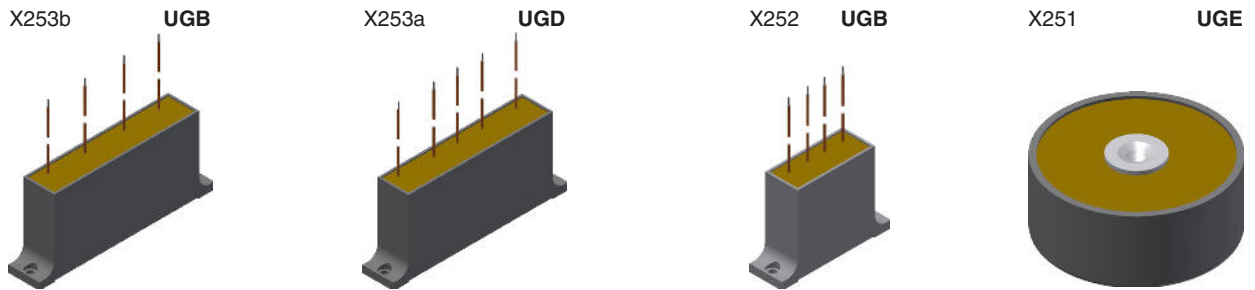

Braking Rectifier Assemblies

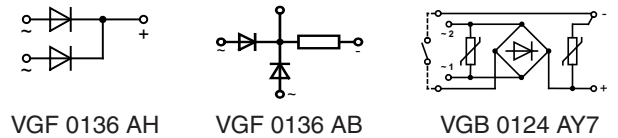

Type	V_{VRMS} typ. V	V_{dAV} typ. V	I_{dAVM} typ. A	I_{dAVM} max. A	V_{RRM} max. V	I_{FSM} max. A	I^2t max. A ² s	Fig. No.	Package style Outline drawings on pages O-31...O-52
VGB 0124AY7a	380	340	1.0	1.0	1400	60	28	X254	
VGF 0136AB	1000	440	1.2	1.5	2800	80	40	X255	
VGF 0136AH	1000	440	0.6	1.1	1400	60	28	X256	

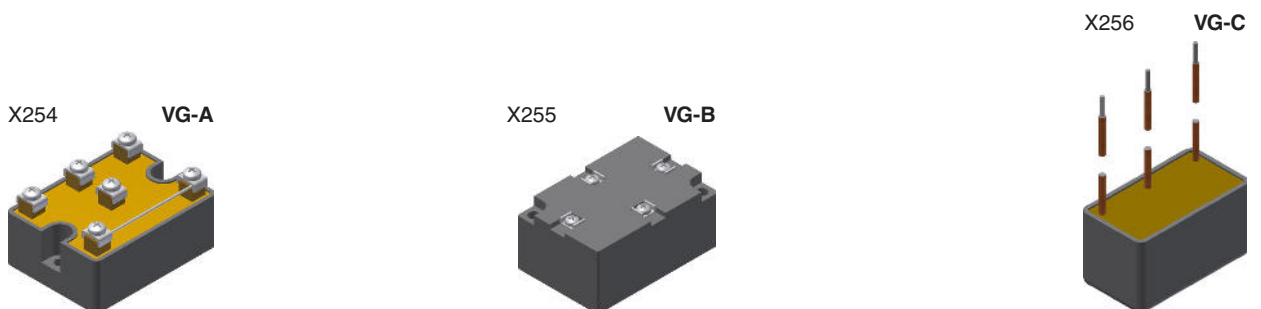

IXBOD 2 - Fast Break-Over Diodes

Advantages compared with IXBOD 1:

- Temperature coefficient K_T reduced by a factor of 3
 - tighter definition of the break-over voltage V_{BO}
 - $V_{BO}(T_{VJ}) = V_{BO, 25^\circ C} [1 + K_T (T_{VJ} - 25^\circ C)]$
 - more precise and controllable design due to smaller tolerances
- Significant reduction of the switching-on time down to a few nanoseconds

Applications:

- Protection circuits for thyristors in high valuable designs
 - high DC current power transmissions for long distances like offshore windmills or hydroelectric dams
- High Intensity Discharge Lighting (HID)

Fast Break-Over Diodes

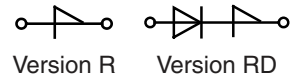

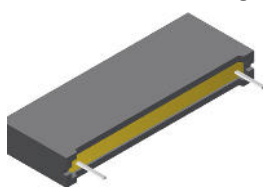
Type	V_{BO} $T_{VJ} = 25^\circ C$ $K_T = 0.7 \cdot 10^{-3} K^{-1}$ V	I_{BO} mA	I_H $T_{VJ} = 25^\circ C$ mA	V_H V	I_D $T_{VJ} = 125^\circ C$ $V_D = 0.8 \cdot V_{BO}$ μA	I_{AVM} ① $T_{amb} = 50^\circ C$ A	I_{SM} A	dv/dt V/ μs	R_{thJA} K/W	Fig. No.	Package style Outline drawings on pages O-31...O-52
➤ New											
IXBOD 2-01	100	15	20	4-8	200	0.90	250	>1000	60	X201	X201 FP-Case (oil proof) 
IXBOD 2-02	200 $\pm 10\%$										
IXBOD 2-03	300 $\cdot V_{BO}$										
IXBOD 2-04	400										
IXBOD 2-05	500 ± 50										
IXBOD 2-06	600										
IXBOD 2-07	700										
IXBOD 2-08	800										
IXBOD 2-09	900										
IXBOD 2-10	1000										
IXBOD 2-11	1100										
IXBOD 2-12	1200										
IXBOD 2-13	1300										
IXBOD 2-14	1400										
IXBOD 2-15R	1500 ± 50	15	20	4-8	200	0.90	250	>1500	20	X202	X202 BOD-Package 
IXBOD 2-15RD											
IXBOD 2-16R	1600										
IXBOD 2-16RD											
IXBOD 2-17R	1700										
IXBOD 2-17RD											
IXBOD 2-18R	1800										
IXBOD 2-18RD											
IXBOD 2-19R	1900										
IXBOD 2-19RD											
IXBOD 2-20R	2000										
IXBOD 2-20RD											
IXBOD 2-21R	2100										
IXBOD 2-21RD											
IXBOD 2-22R	2200										
IXBOD 2-22RD											
IXBOD 2-23R	2300										
IXBOD 2-23RD											
IXBOD 2-24R	2400										
IXBOD 2-24RD											
IXBOD 2-25R	2500										
IXBOD 2-25RD											
IXBOD 2-26R	2600										
IXBOD 2-26RD											
IXBOD 2-27R	2700										
IXBOD 2-27RD											
IXBOD 2-28R	2800										
IXBOD 2-28RD											

Fast Break-Over Diodes

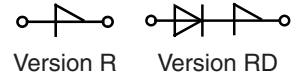

Type	V_{BO}	I_{BO}	I_H	V_H	I_D	I_{AVM} ①	I_{SM}	dv/dt	R_{thJA}	Fig. No.	Package style Outline drawings on pages O-31...O-52	
	$T_{VJ} = 25\text{ °C}$ $K_T = 0.7 \cdot 10^{-3}\text{ K}^{-1}$	$T_{VJ} = 25\text{ °C}$		$T_{VJ} = 125\text{ °C}$ $V_D = 0.8 \cdot V_{BO}$	$T_{amb} = 50\text{ °C}$							
➤ New	V	mA	mA	V	μA	A	A	V/μs	K/W			
IXBOD 2-29R	2900 ±50	15	20	4-8	200	0.90	250	>2500	20	X202	<p>X202 BOD-Package</p>	
IXBOD 2-29RD												
IXBOD 2-30R	3000											
IXBOD 2-30RD												
IXBOD 2-31R	3100											
IXBOD 2-31RD												
IXBOD 2-32R	3200											
IXBOD 2-32RD												
IXBOD 2-33R	3300											
IXBOD 2-33RD												
IXBOD 2-34R	3400											
IXBOD 2-34RD												
IXBOD 2-35R	3500											
IXBOD 2-35RD												
IXBOD 2-36R	3600											
IXBOD 2-36RD												
IXBOD 2-37R	3700											
IXBOD 2-37RD												
IXBOD 2-38R	3800											
IXBOD 2-38RD												
IXBOD 2-39R	3900											
IXBOD 2-39RD												
IXBOD 2-40R	4000											
IXBOD 2-40RD												
IXBOD 2-41R	4100											
IXBOD 2-41RD												
IXBOD 2-42R	4200											
IXBOD 2-42RD												
IXBOD 2-43R	4300 ±50	15	20	4-8	200	0.90	250	>3500	20			
IXBOD 2-44R	4400											
IXBOD 2-45R	4500											
IXBOD 2-46R	4600											
IXBOD 2-47R	4700											
IXBOD 2-48R	4800											
IXBOD 2-49R	4900											
IXBOD 2-50R	5000											
IXBOD 2-51R	5100											
IXBOD 2-52R	5200											
IXBOD 2-53R	5300											
IXBOD 2-54R	5400											
IXBOD 2-55R	5500											
IXBOD 2-56R	5600											

① Leads soldered on PCB board, T_{stg} and $T_{VJ} = -40 \dots +125\text{ °C}$

Power Relays

For a complete listing of IXYS Integrated Circuits Division's Solid-State Relay products, please visit: www.ixysic.com

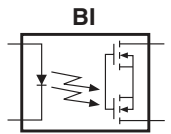

1-Form-A Relays: Single-Pole, Bidirectional

Part No.	Relay Type	Blocking Voltage	Load Current			On Resistance	Input Control Current	Switching Speeds	Isolation Voltage	Off-State Leakage	Package Type
			Free Air	5°C/W Heat Sink	T _C = 25°C						
➤ New		V _P	A _{rms}	A _{rms}	A _{rms}	Ω	mA	t _{on} / t _{off}	V _{rms}	μA	
CPC1906Y	BI	60	2	-	-	0.3	10	10 / 5	2500	1	36
➤ CPC1907B	BI	60	6	-	-	0.06	5	5 / 1	5000	1	66
CPC1908J	BI	60	3.5	8.5	15	0.3	10	20 / 5	2500	1	29
CPC1909J	BI	60	6.5	15	15	0.1	10	25 / 10	2500	1	37
CPC1916Y	BI	100	2.5	-	-	0.34	10	5 / 3	2500	1	36
CPC1918J	BI	100	5.25	13	15	0.1	10	25 / 10	2500	1	37
CPC1926Y	BI	250	0.7	-	-	1.4	10	10 / 10	2500	1	36
CPC1927J	BI	250	2.7	6.7	15	0.2	10	25 / 10	2500	1	37
CPC1967J	BI	400	1.35	3.35	13.15	0.85	10	20 / 5	2500	1	29
➤ CPC1968J	BI	500	2	5	15	0.35	10	20 / 5	2500	1	37
CPC1973Y	BI	400	0.35	-	-	5	10	5 / 3	2500	1	36
CPC1977J	BI	600	1.25	3.1	12.25	1	10	20 / 5	2500	1	29
CPC1978J	BI	800	0.75	1.85	7.25	2.3	10	20 / 5	2500	1	29
CPC1979J	BI	600	1.4	3.5	14.5	0.75	10	25 / 5	2500	1	37
CPC1981Y	BI	1000	0.18	-	-	18	10	10 / 5	2500	1	36
➤ CPC1983B	BI	600	0.5	-	-	6	5	5 / 2	5000	1	66
CPC1983Y	BI	600	0.5	-	-	6	5	5 / 2	2500	1	36
➤ CPC1983YE	BI	600	0.5	-	-	6	5	5 / 2	4000	1	36
CPC1986J	BI	1000	0.65	1.6	6.5	3	10	20 / 5	2500	1	29
CPC1988J	BI	1000	0.9	2.25	9.4	2.5	10	20 / 5	2500	1	37

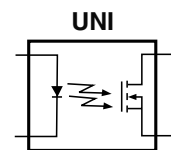

1-Form-A Relays: Single-Pole, Unidirectional

CPC1706Y	UNI	60	4	-	-	0.09	5	5 / 2	2500	1	36
CPC1708J	UNI	60	4	11.85	24	0.08	10	20 / 5	2500	1	29
CPC1709J	UNI	60	9	22.8	32	0.05	10	20 / 5	2500	1	37
CPC1718J	UNI	100	6.75	17.5	32	0.075	10	20 / 5	2500	1	37
CPC1726Y	UNI	250	1	-	-	0.75	10	5 / 2	2500	1	36
CPC1727J	UNI	250	3.4	8.6	20	0.09	10	20 / 5	2500	1	37
CPC1777J	UNI	600	1.5	4.6	15	0.5	10	20 / 5	2500	1	29
CPC1779J	UNI	600	1.65	4.12	15	0.4	10	20 / 5	2500	1	37
CPC1786J	UNI	1000	0.65	1.75	6.9	2	10	20 / 5	2500	1	29
CPC1788J	UNI	1000	1	2.45	10.3	1.25	10	20 / 5	2500	1	37

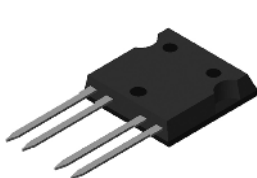

29

i4-PAC

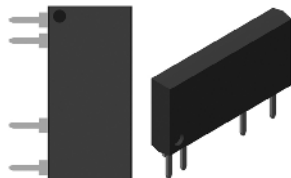

36

Power SIP

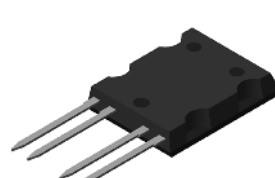

37

ISOPLUS-264

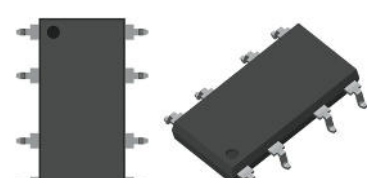

66

Power SOIC

Optically Isolated AC Power Switches

The OptoMOS line of power products uses dual power-SCR outputs to produce an alternative to optocoupler and Triac circuits. These AC Power Switches provide a blocking voltage of up to 800V_P. In addition, tightly controlled zero-cross circuitry ensures switching of AC loads while minimizing the generation of transients. The input and output circuits are optically coupled to provide 3750V_{rms} of isolation and noise immunity between control and load circuits. Long life and environmental integrity make these power switches ideal for controlling a variety of AC circuits in industrial environments where electromagnetic interference would disrupt the operation of electromechanical relays.

Optically Isolated AC Power Switches: I_{LOAD} ≤ 1A

Part No.	Blocking Voltage V _P	Load Current A _{rms}	Input Control Current mA	Operating Frequency min. Hz max.	Isolation Voltage V _{rms}	Fig. No.
➤ New						
CPC1943	400	0.5	5	20 - 500	3750	15, 16
CPC1945G	400	1	5	20 - 400	3750	2
CPC1945Y	400	1	5	20 - 400	3750	23
CPC1961	600	0.25	5	20 - 500	3750	20, 22
CPC1963	600	0.5	5	20 - 500	3750	15, 16
➤ CPC1964G	800	1	5	20 - 500	2500	2
➤ CPC1964Y	800	1	5	20 - 500	2500	23
CPC1965G	600	1	5	20 - 400	3750	2
CPC1965Y	600	1	5	20 - 400	3750	23
CPC1972	800	0.25	5	20 - 500	3750	12, 14
PD1201	400	1	5	20 - 500	3750	2
PD2401	500	1	5	20 - 500	3750	2
PD2601	600	1	5	20 - 500	3750	2
PM1204	400	0.5	5	20 - 500	3750	15, 16
PM1205	500	0.5	5	20 - 500	3750	15, 16
PM1206	600	0.5	5	20 - 500	3750	15, 16
PS1201	400	1	5	20 - 500	3750	23
PS2401	500	1	5	20 - 500	3750	23
PS2601	600	1	5	20 - 500	3750	23

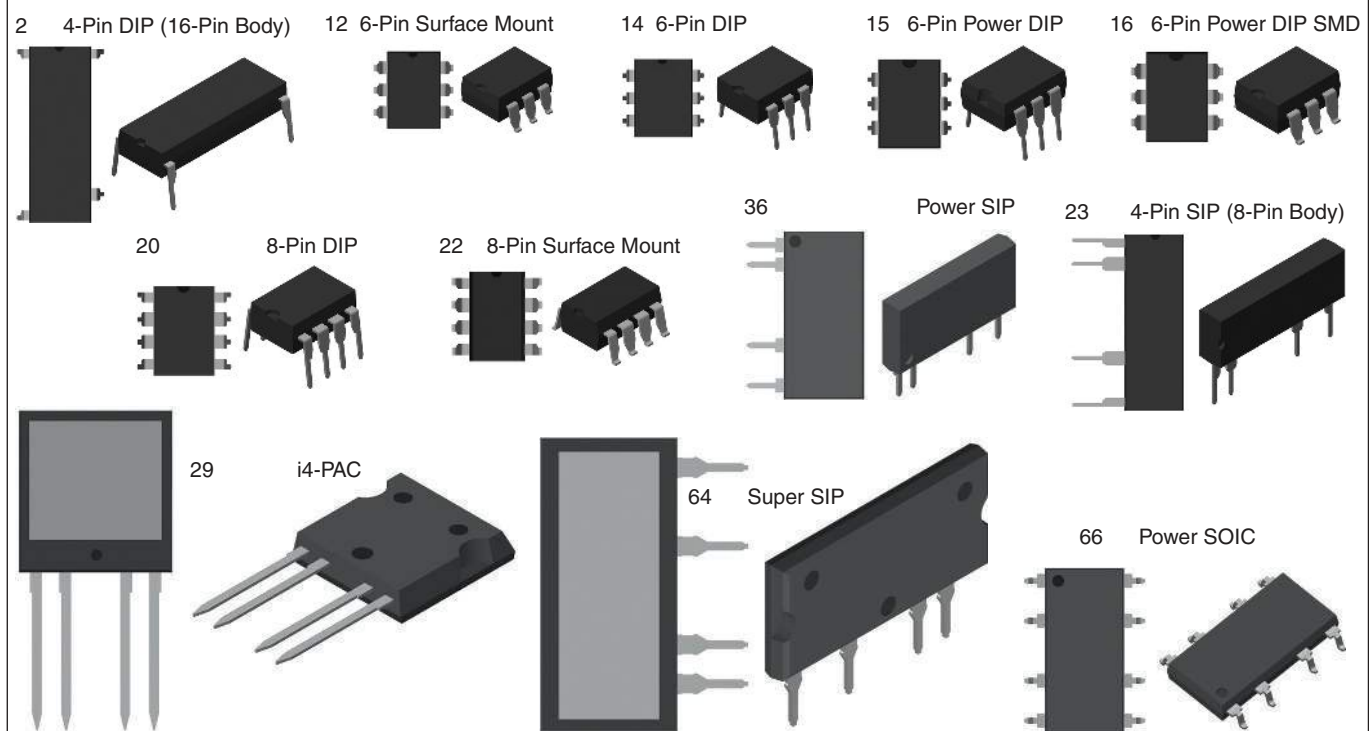

Part Number	Blocking Voltage V _P	Load Current			Input Control Current mA	Input Control Voltage V	Operating Frequency-Range Hz	Isolation Voltage V _{rms}	Fig. No.
		No Heat Sink A _{rms}	with 5°C/W Heat Sink A _{rms}	T _C = 25°C A _{rms}					
➤ New									
➤ CPC1964B	800	1.5	-	-	5	-	20 - 500	5000	66
➤ CPC1964BX6	600	1.5	-	-	5	-	20 - 500	5000	66
CPC1966	600	3	-	-	5	-	20 - 500	3750	36
CPC1966B	800	3	-	-	5	-	20 - 500	5000	66
➤ CPC1966YX6	600	3	-	-	5	-	20 - 500	3750	36
CPC1976	600	2	-	-	5	-	20 - 500	3750	36
➤ CPC1976YX6	600	2	-	-	5	-	20 - 500	3750	36
CPC1998J	800	5	20	50	5	-	20 - 500	2500	29
➤ CPC40055ST	800	5	20	40	5	-	20 - 500	2500	64
➤ CPC40055ST	800	5	20	40	-	9 - 16	20 - 500	2500	64

For data sheets, go to www.ixysic.com/Products/ProdList.htm

Gate Drivers

These ultra-fast, high current MOSFET and IGBT gate drivers are optimized for high efficiency performance in motor drive and power conversion applications. With output current ratings of 1.5A to 30A, they are designed to switch the largest MOSFETs and IGBTs with minimum switching times and at frequencies up to 10MHz. Depending on the output current rating, these gate drivers are offered in DFN (56), SOIC (54), Power SOIC (53), DIP (20), TO-220 (57), and TO-263 (58) packages. "F" versions include one inverting driver and one non-inverting driver, "I" versions are inverters, "N" versions are non-inverters, and "D" versions are non-inverters that include an enable function.

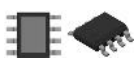
Part No.	Output Type	I_{PEAK} $T_C = 25^\circ C$	Output Resistance	Logic Config.	Enable Function	Undervoltage Lockout	Fig. No.	Package Type
➤ New		A_P	Ω			V		
➤ IX4423	DUAL	3	4	I	-	-	54	20 8-Pin DIP Package Code: PI 
➤ IX4424	DUAL	3	4	N	-	-	54	
➤ IX4425	DUAL	3	4	F	-	-	54	
➤ IX4426	DUAL	1.5	9	I	-	-	54, 56	
➤ IX4427	DUAL	1.5	9	N	-	-	54, 56	
➤ IX4428	DUAL	1.5	9	F	-	-	54, 56	
IXD_602*	DUAL	2	4	F, I, N	-	-	20, 53, 54, 56	53 8-Pin Power SOIC Package Code: SI with exposed metal back 
IXD_604*	DUAL	4	2.5	F, I, N, D	• (D)	-	20, 53, 54, 56	
IXD_609*	SINGLE	9	1	I, N, D	• (D)	-	20, 53, 54, 56, 57, 58	
IXD_614*	SINGLE	14	0.8	I, N, D	• (D)	-	20, 53, 57, 58	
IXD_630*	SINGLE	30	0.4	I, N, D	• (D)	$V_{CC} \leq 12.5$	57, 58	
IXD_630M*	SINGLE	30	0.4	I, N, D	• (D)	$V_{CC} \leq 9$	57, 58	

* = Package Code

Features:

- 1.5A to 30A Peak Source / Sink Drive Current
- Wide Operating Voltage Range: 4.5V to 35V
- -40°C to +125°C Extended Operating Temperature Range
- Logic Input Withstands Negative Swing of up to -5V
- Matched Rise and Fall Times
- Low Propagation Delay Time
- Low 10mA Supply Current
- Low Output Impedance

Applications:

- Efficient Power MOSFET and IGBT Switching
- Switch Mode Power Supplies
- Motor Controls
- DC to DC Converters
- Class-D Switching Amplifiers
- Pulse Transformer Driver

IXD_604SI/SIA, IXD_609SI and IXD_614SI are AEC Q100 Qualified!

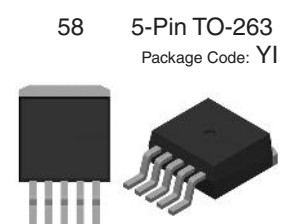
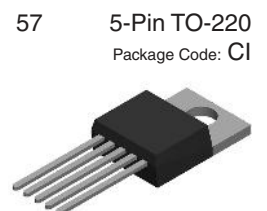
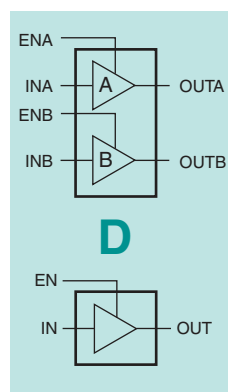
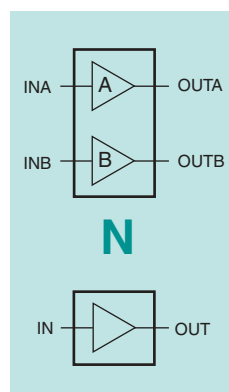
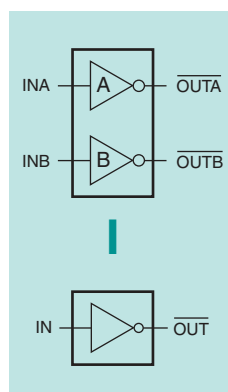
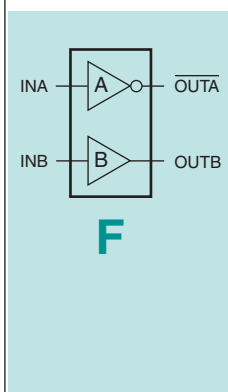

For data sheets, go to www.ixysic.com/Products/ProdList.htm

Gate Drivers

IX2113 600V High-Side & Low-Side MOSFET and IGBT Gate Driver

The IX2113 is a high voltage integrated circuit that can drive high speed MOSFETs and IGBTs that operate at up to +600V. The IX2113 is configured with independent high-side and low-side referenced output channels, both of which can source and sink 2A. The floating high-side channel can drive an N-channel power MOSFET or IGBT 600V from the common reference. IX2113 is supplied in a 16-pin SOIC package or a 14-pin DIP package.

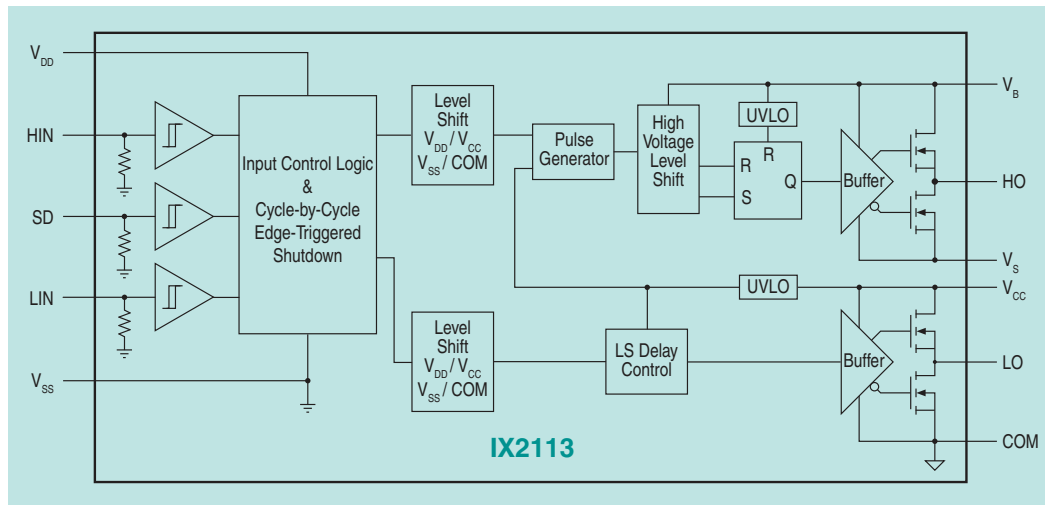

Features:

- Floating Channel for Bootstrap Operation up to 600V with an absolute maximum Rating of 700V
- Outputs Capable of Sourcing and Sinking 2A
- Gate Drive Supply Range From 10V to 20V
- Enhanced Robustness due to SOI Process
- Tolerant to Negative Voltage Transients: dV/dt Immune
- 3.3V Logic Compatible
- Undervoltage Lockout for Both High-Side and Low-Side Outputs
- Matched Propagation Delays

IX21844 High Voltage Half-Bridge Gate Driver

The IX21844 is a high voltage IC that can drive high speed MOSFETs and IGBTs that operate at up to +600V. The IX21844 is configured with dependent high-side and low side referenced output channels that can source 1.4A and sink 1.8A. The floating high-side channel can drive an N-channel power MOSFET or IGBT 600V from the common reference. A programmable dead-time can be set between 400ns and 5ms to ensure that both the high-side and low-side power MOSFET or IGBT are not enabled at the same time.

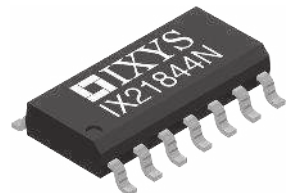
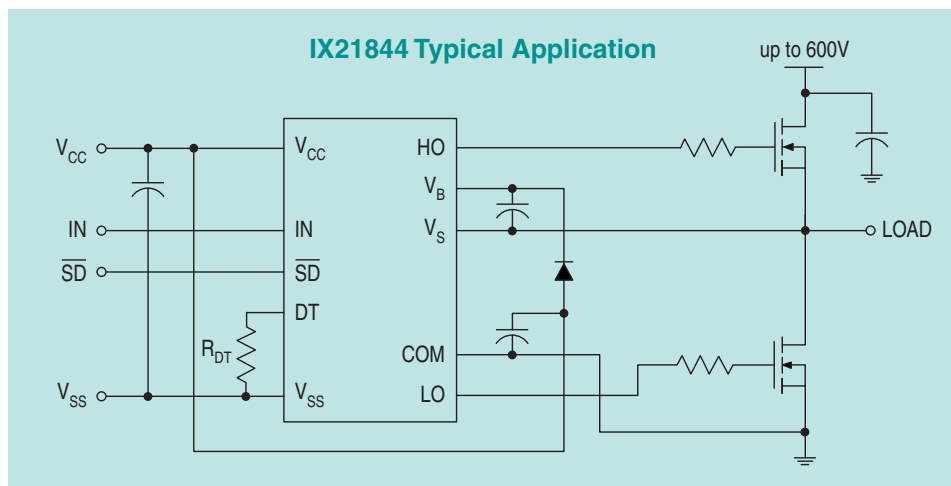

Features:

- Floating Channel for Bootstrap Operation to +600V with an Absolute Maximum Rating of +700V
- Programmable Dead Time
- Outputs Can Source 1.4A and Sink 1.8A
- Gate Drive Supply Range From 10V to 20V
- Tolerant to Negative Voltage Transients: dV/dt Immune
- 3.3V and 5V Logic Compatible
- Undervoltage Lockout for Both High-side and Low-Side Outputs
- Matched Propagation Delays

Applications:

- Switch Mode Power Supplies
- Motor Driver Inverters
- DC/DC Converters
- Uninterruptable Power Supplies (UPS)

For data sheets, go to www.ixysic.com/Products/ProdList.htm

Gate Drivers

IX2127 600V High-Side MOSFET and IGBT Gate Driver

The IX2127 is a high voltage, high-speed power MOSFET and IGBT driver. The device's high voltage level-shift technique enables it to operate at up to 600V. Proprietary common-mode design techniques provide stable operation in high dV/dt noise environments.

The IX2127 detects an over-current condition in the driven MOSFET or IGBT device, and shuts down drive to that device. An open-drain output, FAULT, indicates that an over-current shutdown has occurred. The gate driver output typically can source 250mA and sink 500mA, which is suitable for fluorescent lamp ballast, motor control, SMPS, and other converter drive topologies. Available in 8-pin DIP and 8-pin SOIC packages.

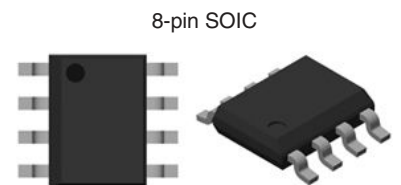
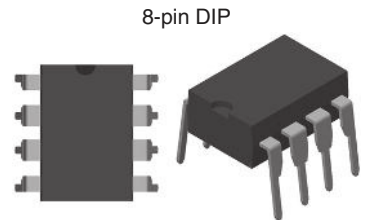
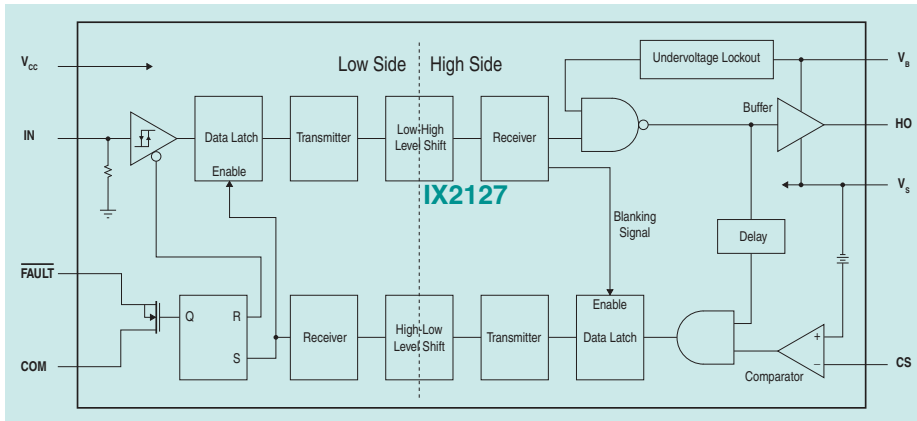

Features:

- Floating Channel Designed for Bootstrap Operation up to 600V
- Tolerant to Negative Transient Voltages; dV/dt Immune
- Undervoltage Lockout
- 3.3V, 5V, and 12V Input Logic Compatible
- Open-Drain FAULT Indicator Pin shows Over-Current Shutdown
- Output in Phase with the Input

Applications:

- High Speed Gate Driver
- Motor Drive Inverter

IX2204 Dual Low Side IGBT Gate Driver

The IX2204 is a dual high current gate driver specifically designed to drive the gates of high current IGBTs. The IX2204 provides two high current outputs capable of sourcing 2A and sinking 4A. The outputs can be paralleled for IGBT gates that require higher drive current. The outputs have a wide operating voltage range, and are able to provide a negative gate drive voltage to ensure the turn-off of high power IGBTs. A desaturation detection circuit protects the power IGBT during a short circuit. The IX2204 has a programmable two-level turn-off feature that protects the device against excessive voltages when the IGBT is being turned off due to an over-current situation. The IX2204 has under voltage lockout circuitry, a fault status output, and is available in a 16-lead thermally enhanced SOIC package.

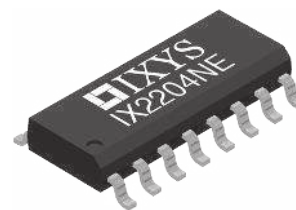
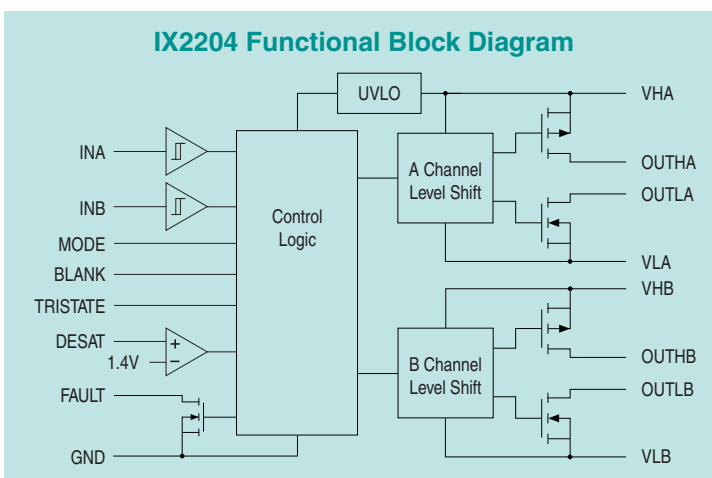

Features:

- High Output Current: 2A Source / 4A Sink
- Wide Operating Voltage Range: -10V to +26V
- Negative Gate Drive Capability
- Desaturation Detection Circuit
- Separate Source and Sink Outputs
- Programmable Blanking and Output Tristate
- TTL Compatible Inputs
- -40°C to +125°C Extended Operating Temperature Range
- Under-Voltage Lockout Circuitry
- Fault Status Output

Applications:

- Efficient IGBT Switching
- Motor Controls
- Switch Mode Power Supplies

For data sheets, go to www.ixysic.com/Products/ProdList.htm

Gate Drivers

IX3120 2.5A-Output Optically Coupled Gate Driver

The IX3120 Gate Driver includes an input infrared LED that is optically coupled to a power output stage. The power output stage is capable of sourcing or sinking 2.5A of peak current, which is ideal for driving IGBTs and MOSFETs in the mid-power range. The gate driver optocoupler with its low input LED current, high output peak current, and high noise immunity (25kV/ms) is ideally suited for use in motor control and inverter applications. The IX3120 is provided in an 8-pin DIP package and an 8-pin surface mount package.

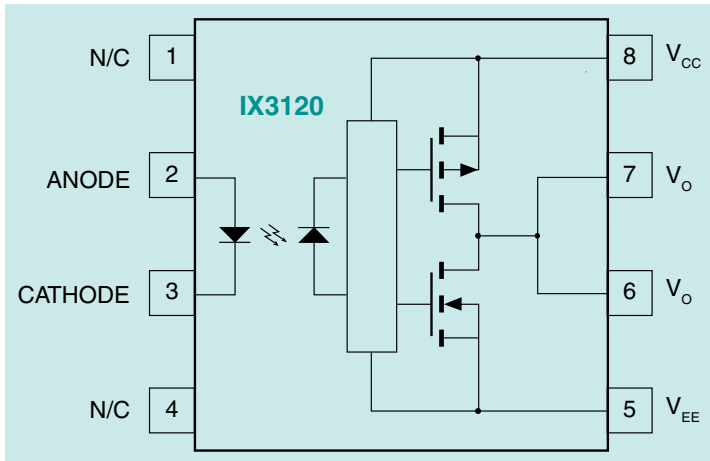

Applications:

- Isolated IGBT / MOSFET Gate Drive
- Switch Mode Power Supplies
- Industrial Inverters
- Motor Drivers

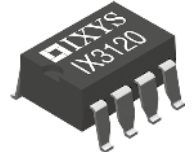

Features:

- 2.5A Maximum Peak Output Current
- 25kV/ μ s Minimum Common Mode Rejection (CMR) at 1500V_{CM}
- Wide Operating Voltage Range: 15V to 30V
- Undervoltage Lockout with Hysteresis
- 3750V_{rms} Input to Output Isolation
- Wide Temperature Range: -40°C to +100°C

IX3180 2.5A Output Current High Speed Gate Driver Optocoupler

The IX3180 is a high speed MOSFET gate drive optocoupler. It consists of an input infrared LED that is optically coupled to an integrated power gate driver that is capable of sourcing and sinking 2.5A of peak current. The IX3180 is ideally suited for high frequency driving of power MOSFETs used in high performance, DC/DC converters, motor control inverter applications, and high performance switching power supplies.

The IX3180 is available in an 8-pin DIP package and an 8-pin surface mount package.

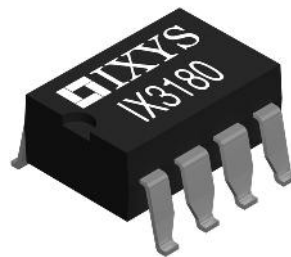
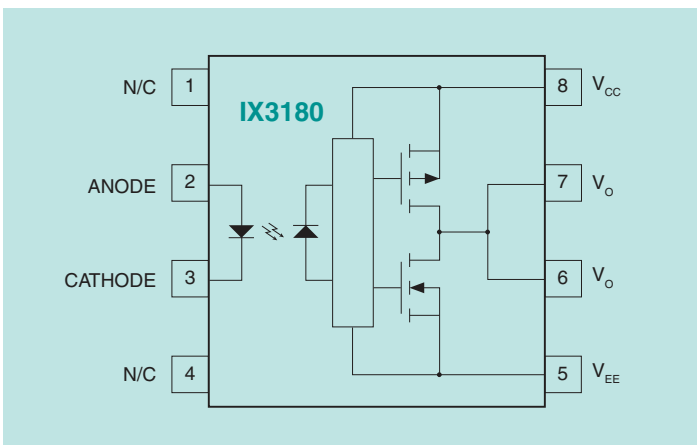

Applications:

- Isolated Power MOSFET Gate Drive
- Switch Mode Power Supplies
- Industrial Inverters
- Motor Drivers

Features:

- 2.5A Maximum Peak Output Current
- 200ns Maximum Propagation Delay Over Temperature Range
- 20ns Typical Pulse Width Distortion
- 10kV/ μ s Minimum Common Mode Rejection (CMR) at 1500V_{CM}
- Wide Operating Voltage Range: 10V to 20V
- Undervoltage Lockout with Hysteresis
- 3750V_{rms} Input to Output Isolation
- Wide Temperature Range: -40°C to +100°C

For data sheets, go to www.ixysic.com/Products/ProdList.htm

Gate Drivers

Optically Isolated Gate Drivers

The CPC1580 and CPC1590 are high speed, optically isolated Gate Driver ICs. On-chip circuitry charges an external capacitor from the load voltage which eliminates the need for an external IC power supply. These Gate Drivers are ideal for low duty cycle switching applications. Both devices are provided in an 8-pin flatpack package.

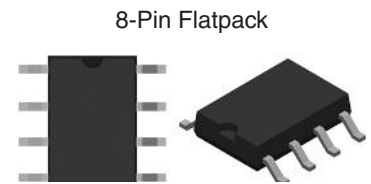
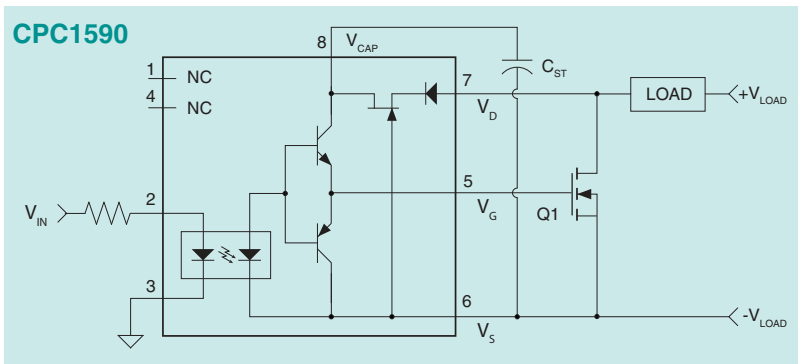

Features:

- No External IC Power Supply
- Low Drive Power Requirements (TTL/CMOS Compatible)
- Load Voltages up to 200V
- Fast Switching Times - On: 40µsec / Off: 400µsec

Applications:

- Instrumentation
- Multiplexers
- I/O Subsystems
- Meters (Watt-Hour, Water, Gas)
- Medical Equipment (Patient / Equipment Isolation)
- Security
- Aerospace
- Industrial Controls

Part Number	Input Control Current (mA)	Gate Voltage @ $I_F = 5\text{mA}$ (V_P)	Blocking Voltage (V_P)	Regulated Capacitor Voltage ($V_{CAP-MAX}$)	Switching Speeds t_{on} / t_{off} (μs)	Isolation Voltage (V_{rms})
CPC1580	2.5	7.5 - 12	65	$V_{DS} - 0.2\text{V}$	40 / 400	3750
CPC1590	2.5	7.5 - 12	200	16	40 / 400	3750

Optically Isolated Dual MOSFET Gate Drivers

These Dual Optically Isolated Photodiode Arrays, which can produce an open-circuit voltage of up to 12V, are well suited for use in discrete solid state relay designs. The FDA215 and the FDA217 are provided in either an 8-pin DIP package or in an 8-pin surface-mount package.

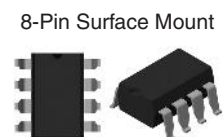
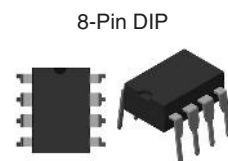
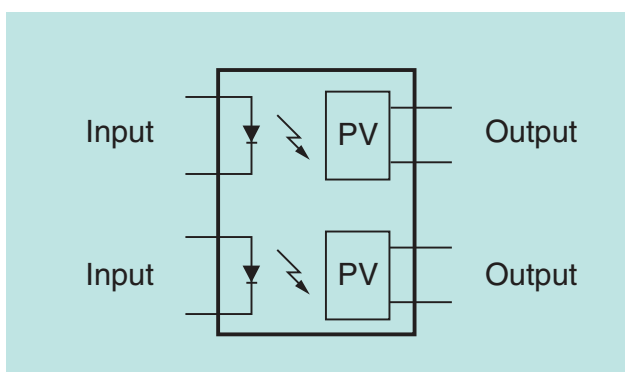

Features:

- Isolated 5.5V to 12V Photovoltaic Output
- Floating Outputs for Parallel or Series Configuration

Applications:

- MOSFET Driver
- Isolated Floating Power Source

Part No.	Input Control Current (mA)	Nominal Open-Circuit Voltage V_{oc} (V)	Nominal Short-Circuit Current I_{sc} (μA)	Switching Speeds t_{on} / t_{off} (ms)	Isolation Voltage V_{rms}	Package Type
FDA215	5	5.5	2.5	5 / 5	3750	8-Pin DIP, 8-Pin Surface Mount
FDA217	5	11.75	4.5	2 / 0.5	3750	8-Pin DIP, 8-Pin Surface Mount

For data sheets, go to www.ixysic.com/Products/ProdList.htm

Linear Optocouplers

OptoMOS Linear Optocouplers feature an infrared LED optically coupled to a pair of photodiodes. The input photodiode is used to generate a feedback signal that provides a servomechanism to the LED drive current thus compensating for the LED's nonlinear characteristics. The output photodiode provides an isolated output signal that is linear with respect to the servo LED current.

Features:

- Couples Analog & Digital Signals
- 3750V_{rms} Input / Output Isolation
- Bandwidth >200kHz in Photoconductive Mode
- Bandwidth 40kHz in Photovoltaic Mode
- High Gain Stability
- Low Input / Output Capacitance
- Low Power Consumption
- 0.01% Servo Linearity
- THD 87dB Typical
- Machine Insertable, Wave Solderable

Applications:

- Power Supply Feedback Voltage / Current
- Medical Sensor Interfacing
- Isolation of Process Control Transducers
- Isolated 4-20mA Converters
- Digital Telephone Isolation

Part Number	Servo Gain K1 = I ₁ /I _F Min / Max	Forward Gain K2 = I ₂ /I _F Min / Max	Transfer Gain K3 = K ₂ /K ₁ Min / Max	Input Control Current mA	Isolation Voltage V _{rms}	Package Type
LOC110	0.004 / 0.03	0.004 / 0.03	0.668 / 1.179	2 - 10	3750	20, 21, 22
LOC111	0.008 / 0.03	0.006 / 0.03	0.733 / 1.072	2 - 10	3750	20, 21, 22
LOC112	0.004 / 0.03	0.004 / 0.03	0.733 / 1.072	2 - 10	3750	20, 21, 22
LOC117	0.008 / 0.03	0.006 / 0.03	0.887 / 1.072	2 - 10	3750	20, 21, 22
LOC210	0.004 / 0.03	0.004 / 0.03	0.773 / 1.072	2 - 10	3750	4
LOC211	0.008 / 0.03	0.006 / 0.03	0.773 / 1.072	2 - 10	3750	4

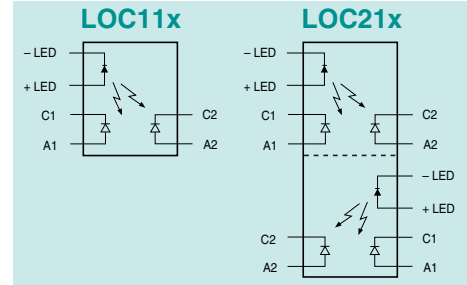

Two Fundamental Operating Configurations:

Photoconductive Mode:

- Wide Bandwidth (>200kHz)
- 8-bit Linearity

Photovoltaic Mode:

- 14-bit Linearity
- 40kHz Bandwidth

Isolation Amplifier (Photovoltaic Mode)

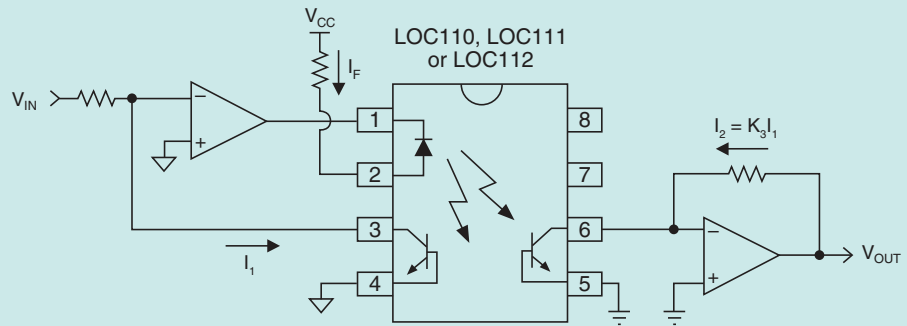

N-Channel Depletion Mode FETs

Our N-channel depletion mode Field Effect Transistors (FETs) utilize a proprietary third generation vertical DMOS process. The third generation process realizes world class, high voltage MOSFET performance in an economical silicon gate process. The vertical DMOS process yields a robust device for low-power applications with high input impedance. These highly reliable FET devices have been used extensively in our solid state relays for industrial and telecommunications applications. These normally on MOSFETs are well suited for low cost, pre-regulator applications that are tolerant of high voltage drop and power dissipation between the power source and the output regulator stage.

Part Number	V _{(BR)DSX} (V)	R _{DS(on)} Max (W)	V _{GS(off)} Min (V)	V _{GS(off)} Max (V)	I _{DSS} @ V _{GS} = 0V Min (mA)	I _D @ V _{GS} = -0.57V Min (mA)	Package Type
CPC3701	60	1	-0.8	-2.9	600	-	89
CPC3703	250	4	-1.6	-3.9	360	-	89
CPC3708	350	14	-2	-3.6	-	130	89 / 223
CPC3710	250	10	-1.6	-3.9	220	-	89
CPC3714	350	14	-1.6	-3.9	240	-	89
CPC3720	350	22	-1.6	-3.9	130	-	89
CPC3730	350	30	-1.6	-3.9	140	-	89
CPC3902	250	2.5	-1.4	-3.1	400	-	223
CPC3909	400	9	-0.9	-3.1	300	-	89 / 223
CPC3960	600	44	-1.4	-3.1	100	-	223
CPC3980	800	45	-1.4	-3.1	100	-	223
CPC3982	800	380	-1.4	-3.1	20	-	223
CPC5602	350	14	-2	-3.6	-	130	223
CPC5603	415	14	-2	-3.6	-	130	223

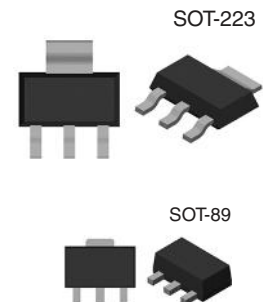

- Use of a rectifier diode above T_{JMAX} with a short term overload
- Leakage current against temperature and applied voltage
- Setting disc spring type clamps
- Replacement of devices in assembly type XA3370ZX12WRs
- Possible failure modes in press-pack devices
- Recommended clamps for capsule semiconductors
- Guidance for soldering leads to thyristors, GTO thyristors and IGBT's
- Device mounting instruction
- Stocking & handling requirements for press-pack and module devices
- Recommended maximum force for module gate terminals
- Press releases
- Quality documents
- IXYS UK product nomenclatures

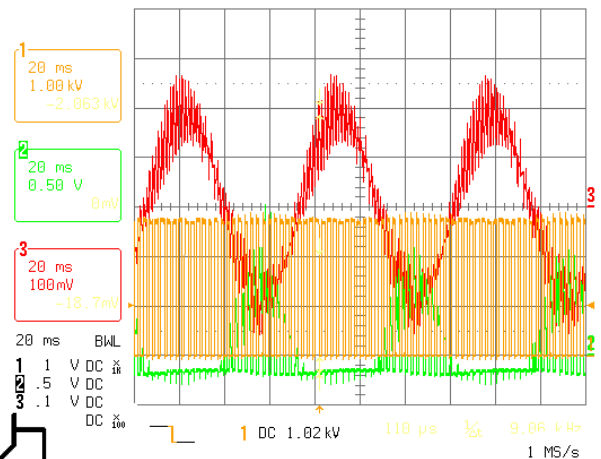
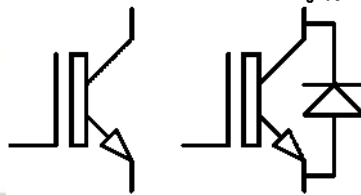
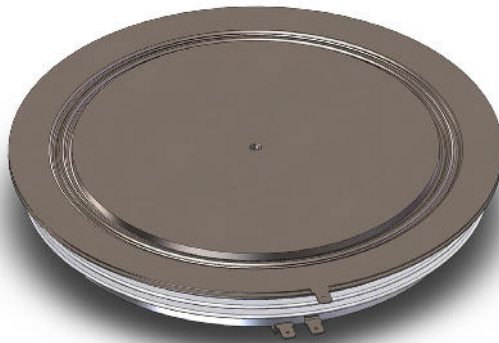





Rectifier Diodes

Our comprehensive range of rectifier diodes offers class leading performance and reliability. Devices are available with blocking voltages from 200V up to 6kV. Optimised to offer low conduction losses, these devices are ideally suited to line frequency applications up to 400Hz including input rectifiers for variable speed drives, traction converters, trackside substations, welding and DC power supplies. Featuring compression bonded, alloyed Silicon wafer construction, these devices feature low thermal impedance and high overload capacity and are designed to survive even the most arduous applications.

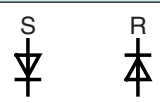







The latest additions to the IXYS UK Rectifier Diode family are four new 83mm dia Si Rectifier Diodes. These new designs use a bonded die construction and improved package design for maximum power to package ratio, as well as better thermal and electromechanical performance. Four new products have been launched offering average current ratings up to 9830A and voltage ratings up to 4800V with further products planned.

Stud Types

Part No.	V_{RRM}	I_{FAV}	I_{FSM}	I^2t	V_{TO}	r_T	T_{JM}	R_{thJC}		Fig. No.	Package style Outlines on pages O-01...O-30
	V	A	A	A ² s	V	mΩ	°C	d.c. 180° sine K/W	120° Rect. K/W		
W0428RE250	2500	428	5500	151 x 10 ³	0.926	0.739	150	0.1300	0.1530	W39	
W0428RE280	2800	428	5500	151 x 10 ³	0.926	0.739	150	0.1300	0.1530	W39	
W0428RE320	3200	428	5500	151 x 10 ³	0.926	0.739	150	0.1300	0.1530	W39	
W0428RF250	2500	428	5500	151 x 10 ³	0.926	0.739	150	0.1300	0.1530	W24	
W0428RF280	2800	428	5500	151 x 10 ³	0.926	0.739	150	0.1300	0.1530	W24	
W0428RF320	3200	428	5500	151 x 10 ³	0.926	0.739	150	0.1300	0.1530	W24	
W0428SE250	2500	428	5500	151 x 10 ³	0.926	0.739	150	0.1300	0.1530	W39	
W0428SE280	2800	428	5500	151 x 10 ³	0.926	0.739	150	0.1300	0.1530	W39	
W0428SE320	3200	428	5500	151 x 10 ³	0.926	0.739	150	0.1300	0.1530	W39	
W0428SF250	2500	428	5500	151 x 10 ³	0.926	0.739	150	0.1300	0.1530	W24	
W0428SF280	2800	428	5500	151 x 10 ³	0.926	0.739	150	0.1300	0.1530	W24	
W0428SF320	3200	428	5500	151 x 10 ³	0.926	0.739	150	0.1300	0.1530	W24	
W0503RC160	1600	503	5500	151 x 10 ³	0.990	0.740	180	0.1300	0.1530	W24	 W23 Weight 250 g
W0503RC200	2000	503	5500	151 x 10 ³	0.990	0.740	180	0.1300	0.1530	W24	
W0503RC240	2400	503	5500	151 x 10 ³	0.990	0.740	180	0.1300	0.1530	W24	
W0503SC160	1600	503	5500	151 x 10 ³	0.990	0.740	180	0.1300	0.1530	W24	 W24 Weight 250 g
W0503SC200	2000	503	5500	151 x 10 ³	0.990	0.740	180	0.1300	0.1530	W24	
W0503SC240	2400	503	5500	151 x 10 ³	0.990	0.740	180	0.1300	0.1530	W24	
W0735RA120	1200	735	9000	405 x 10 ³	0.790	0.342	190	0.1300	0.1530	W23	 W23 Weight 250 g
W0735RA150	1500	735	9000	405 x 10 ³	0.790	0.342	190	0.1300	0.1530	W23	
W0735SA120	1200	735	9000	405 x 10 ³	0.790	0.342	190	0.1300	0.1530	W23	
W0735SA150	1500	735	9000	405 x 10 ³	0.790	0.342	190	0.1300	0.1530	W23	



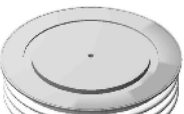

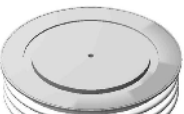
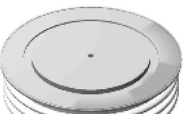





Rectifier Diodes

Capsule Types

Part No.	V _{RRM} V	I _{FAV} T _K = 55°C A	I _{FSM} A	I ² t 10 ms ½ sine V _R - ≤ 60% V _{RRM} A²s	V _{T0} r _T @ T _{JM} V mΩ		T _{JM} °C	R _{thJK} 180° Sine K/W		120° Rect. K/W	Fig. No.	Package style Outlines on pages O-01...O-30
					V	mΩ		K/W	K/W			
W0507YH360	3600	507	7600	289 x 10 ³	0.970	0.880	160	0.1000	0.1170	W3		
W0507YH450	4500	507	7600	289 x 10 ³	0.970	0.880	160	0.1000	0.1170	W3		
W0642WC160	1600	642	5500	151 x 10 ³	0.990	0.740	180	0.0900	0.0980	W1		
W0642WC200	2000	642	5500	151 x 10 ³	0.990	0.740	180	0.0900	0.0980	W1		
W0642WC240	2400	642	5500	151 x 10 ³	0.990	0.740	180	0.0900	0.0980	W1		
W0944WC120	1200	944	9000	405 x 10 ³	0.790	0.342	190	0.0900	0.0980	W1		
W0944WC150	1500	944	9000	405 x 10 ³	0.790	0.342	190	0.0900	0.0980	W1		
W1032LC500	5000	1032	7200	259 x 10 ³	1.000	0.702	150	0.0330	0.0400	W4	W1 Weight 70 g	
W1032LC560	5600	1032	7200	259 x 10 ³	1.000	0.702	150	0.0330	0.0400	W4		
W1032LC600	6000	1032	7200	259 x 10 ³	1.000	0.702	150	0.0330	0.0400	W4		
W1074YC200	2000	1074	10800	583 x 10 ³	0.920	0.390	160	0.0500	0.0610	W2		
W1074YC260	2600	1074	10800	583 x 10 ³	0.920	0.390	160	0.0500	0.0610	W2		
W1074YC320	3200	1074	10800	583 x 10 ³	0.920	0.390	160	0.0500	0.0610	W2		
W1074YH200	2000	1074	10800	583 x 10 ³	0.920	0.390	160	0.0500	0.0610	W3		
W1074YH260	2600	1074	10800	583 x 10 ³	0.920	0.390	160	0.0500	0.0610	W3		
W1074YH320	3200	1074	10800	583 x 10 ³	0.920	0.390	160	0.0500	0.0610	W3		
W1185LC300	3000	1185	9200	423 x 10 ³	1.000	0.575	160	0.0330	0.0393	W4		W2 Weight 80 g
W1185LC380	3800	1185	9200	423 x 10 ³	1.000	0.575	160	0.0330	0.0393	W4		
W1185LC450	4500	1185	9200	423 x 10 ³	1.000	0.575	160	0.0330	0.0393	W4		
W1263YC160	1600	1263	11700	684 x 10 ³	0.870	0.330	175	0.0500	0.0610	W2		
W1263YC200	2000	1263	11700	684 x 10 ³	0.870	0.330	175	0.0500	0.0610	W2		
W1263YC250	2500	1263	11700	684 x 10 ³	0.870	0.330	175	0.0500	0.0610	W2		
W1263YH160	1600	1263	11700	684 x 10 ³	0.870	0.330	175	0.0500	0.0610	W3		
W1263YH200	2000	1263	11700	684 x 10 ³	0.870	0.330	175	0.0500	0.0610	W3		
W1263YH250	2500	1263	11700	684 x 10 ³	0.870	0.330	175	0.0500	0.0610	W3		
W1411LC300	3000	1411	10600	562 x 10 ³	0.900	0.388	160	0.0330	0.0393	W4		W3 Weight 140 g
W1411LC360	3600	1411	10600	562 x 10 ³	0.900	0.388	160	0.0330	0.0393	W4		
W1520NC500	5000	1478	12000	720 x 10 ³	0.904	0.552	150	0.0220	0.0255	W5		
W1520NC600	6000	1478	12000	720 x 10 ³	0.904	0.552	150	0.0220	0.0255	W5		
W1524LC240	2400	1524	12700	810 x 10 ³	0.870	0.323	160	0.0330	0.0393	W4		
W1524LC300	3000	1524	12700	810 x 10 ³	0.870	0.323	160	0.0330	0.0393	W4		
W1748LC180	1800	1748	15400	1.19 x 10 ⁶	0.870	0.280	175	0.0330	0.0393	W4		
W1748LC220	2200	1748	15400	1.19 x 10 ⁶	0.870	0.280	175	0.0330	0.0393	W4		
W1748LC250	2500	1748	15400	1.19 x 10 ⁶	0.870	0.280	175	0.0330	0.0393	W4		
W2054NC360	3600	2054	19000	1.81 x 10 ⁶	0.800	0.300	160	0.0220	0.0274	W5	W4 Weight 340 g	
W2054NC450	4500	2054	19000	1.81 x 10 ⁶	0.800	0.300	160	0.0220	0.0274	W5		
W2058LC100	1000	2058	19500	1.90 x 10 ⁶	0.790	0.192	175	0.0330	0.0393	W4		
W2058LC120	1200	2058	19500	1.90 x 10 ⁶	0.790	0.192	175	0.0330	0.0393	W4		
W2058LC140	1400	2058	19500	1.90 x 10 ⁶	0.790	0.192	175	0.0330	0.0393	W4		
W2115MC520	5200	2122	19000	1.81 x 10 ⁶	1.074	0.405	150	0.0140	0.0160	W54		
W2115MC560	5600	2122	19000	1.81 x 10 ⁶	1.074	0.405	150	0.0140	0.0160	W54		
W2115MC600	6000	2122	19000	1.81 x 10 ⁶	1.074	0.405	150	0.0140	0.0160	W54		
W2134NC300	3000	2134	20000	2.00 x 10 ⁶	0.865	0.260	160	0.0220	0.0274	W5		
W2134NC400	4000	2134	20000	2.00 x 10 ⁶	0.865	0.260	160	0.0220	0.0274	W5		
W2820VC360	3600	2820	26200	3.43 x 10 ⁶	1.300	0.147	160	0.0160	0.0149	W6	W5 Weight 510 g	
W2820VC450	4500	2820	26200	3.43 x 10 ⁶	1.300	0.147	160	0.0160	0.0149	W6		
W2820VF360	3600	2820	26200	3.43 x 10 ⁶	1.300	0.147	160	0.0160	0.0149	W43		
W2820VF450	4500	2820	26200	3.43 x 10 ⁶	1.300	0.147	160	0.0160	0.0149	W43		
W2899MC420	4200	2899	25400	3.23 x 10 ⁶	0.996	0.222	160	0.0140	0.0160	W54		
W2899MC460	4600	2899	25400	3.23 x 10 ⁶	0.996	0.222	160	0.0140	0.0160	W54		
W2899MC480	4800	2899	25400	3.23 x 10 ⁶	0.996	0.222	160	0.0140	0.0160	W54		
W3082MC420	4200	3120	26000	3.38 x 10 ⁶	0.923	0.192	160	0.0140	0.0160	W54		
W3082MC440	4400	3120	26000	3.38 x 10 ⁶	0.923	0.192	160	0.0140	0.0160	W54		
W3082MC450	4500	3120	26000	3.38 x 10 ⁶	0.923	0.192	160	0.0140	0.0160	W54		
W3128VC300	3000	3128	30000	4.50 x 10 ⁶	0.875	0.158	160	0.0160	0.0190	W6	W6 Weight 1000 g	
W3128VC400	4000	3128	30000	4.50 x 10 ⁶	0.875	0.158	160	0.0160	0.0190	W6		
W3128VF300	3000	3128	30000	4.50 x 10 ⁶	0.875	0.158	160	0.0160	0.0190	W43		
W3128VF400	4000	3128	30000	4.50 x 10 ⁶	0.875	0.158	160	0.0160	0.0190	W43		

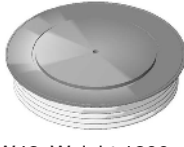
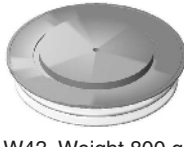











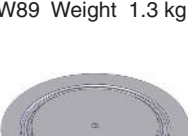

Rectifier Diodes

Capsule Types

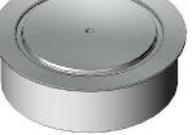
Part No.	V _{RRM}	I _{FAV} T _K = 55°C	I _{FSM} 10 ms ½ sine V _R ≤ 60% V _{RRM}	I ² t A ² S	V _{T0}	r _T @T _{JM}	T _{JM}	R _{thJK}		Fig. No.	Package style Outlines on pages O-01...O-30
								180° Sine	120° Rect.		
➤ New	V	A	A	A ² S	V	mΩ	°C	K/W	K/W		
W3270NC20A *	2000	3239	27600	3.81 x 10 ⁶	0.818	0.108	175	0.0220	0.0260	W5	
W3270NC22A *	2200	3239	27600	3.81 x 10 ⁶	0.818	0.108	175	0.0220	0.0260	W5	
W3270NC200	2000	3270	28000	3.92 x 10 ⁶	0.826	0.104	175	0.0220	0.0260	W5	
W3270NC220	2200	3270	28000	3.92 x 10 ⁶	0.826	0.104	175	0.0220	0.0260	W5	
➤ W3305QK240 ‡	2400	3305	18500	1.71 x 10 ⁶	0.910	0.150	175	0.0170	0.0207	WD2	
➤ W3305QK280 ‡	2800	3305	18500	1.71 x 10 ⁶	0.910	0.150	175	0.0170	0.0207	WD2	
W3455QK200	2000	3455	20000	2.00 x 10 ⁶	0.940	0.139	180	0.0170	0.0207	WD2	
W3455QK220	2200	3455	20000	2.00 x 10 ⁶	0.940	0.139	180	0.0170	0.0207	WD2	
W3477MC360	3600	3470	28200	3.98 x 10 ⁶	0.908	0.146	160	0.0140	0.0160	W54	W7 Weight 1700 g
W3477MC380	3800	3470	28200	3.98 x 10 ⁶	0.908	0.146	160	0.0140	0.0160	W54	
W3477MC400	4000	3470	28200	3.98 x 10 ⁶	0.908	0.146	160	0.0140	0.0160	W54	
W3697VC220	2200	3697	40000	8.00 x 10 ⁶	0.860	0.100	160	0.0160	0.0190	W6	
W3697VC280	2800	3697	40000	8.00 x 10 ⁶	0.860	0.100	160	0.0160	0.0190	W6	
W3697VF220	2200	3697	40000	8.00 x 10 ⁶	0.860	0.100	160	0.0160	0.0190	W43	
W3697VF280	2800	3697	40000	8.00 x 10 ⁶	0.860	0.100	160	0.0160	0.0190	W43	
W3708MC300	3000	3753	30000	4.50 x 10 ⁶	0.958	0.112	160	0.0140	0.0160	W54	W28 Weight 1230 g
W3708MC320	3200	3753	30000	4.50 x 10 ⁶	0.958	0.112	160	0.0140	0.0160	W54	
W3708MC350	3500	3753	30000	4.50 x 10 ⁶	0.958	0.112	160	0.0140	0.0160	W54	
W3743ZC400	4000	3743	35000	6.13 x 10 ⁶	0.976	0.170	160	0.0110	0.0132	W7	
W3743ZC450	4500	3743	35000	6.13 x 10 ⁶	0.976	0.170	160	0.0110	0.0132	W7	
W3743ZC500	5000	3743	35000	6.13 x 10 ⁶	0.976	0.170	160	0.0110	0.0132	W7	
W3743ZD400	4000	3743	35000	6.13 x 10 ⁶	0.976	0.170	160	0.0110	0.0132	W42	
W3743ZD450	4500	3743	35000	6.13 x 10 ⁶	0.976	0.170	160	0.0110	0.0132	W42	
W3743ZD500	5000	3743	35000	6.13 x 10 ⁶	0.976	0.170	160	0.0110	0.0132	W42	
W3841VC300	3000	3841	39800	7.92 x 10 ⁶	0.860	0.115	175	0.0160	0.0190	W6	W29 Weight 1700 g
W3841VC340	3400	3841	39800	7.92 x 10 ⁶	0.860	0.115	175	0.0160	0.0190	W6	
W3841VF300	3000	3841	39800	7.92 x 10 ⁶	0.860	0.115	175	0.0160	0.0190	W43	
W3841VF340	3400	3841	39800	7.92 x 10 ⁶	0.860	0.115	175	0.0160	0.0190	W43	
W3842MC240	2400	3842	35100	6.16 x 10 ⁶	0.831	0.118	160	0.0140	0.0160	W54	
W3842MC280	2800	3842	35100	6.16 x 10 ⁶	0.831	0.118	160	0.0140	0.0160	W54	
W3864QK120	1200	3864	22200	2.46 x 10 ⁶	0.861	0.109	180	0.0170	0.0210	WD2	W42 Weight 1200 g
W3864QK150	1500	3864	22200	2.46 x 10 ⁶	0.861	0.109	180	0.0170	0.0210	WD2	
W3864QK180	1800	3864	22200	2.46 x 10 ⁶	0.861	0.109	180	0.0170	0.0210	WD2	
W4096ZC340	3400	4096	41700	8.70 x 10 ⁶	0.730	0.158	160	0.0110	0.0132	W7	
W4096ZC450	4500	4096	41700	8.70 x 10 ⁶	0.730	0.158	160	0.0110	0.0132	W7	
W4096ZD340	3400	4096	41700	8.70 x 10 ⁶	0.730	0.158	160	0.0110	0.0132	W42	
W4096ZD450	4500	4096	41700	8.70 x 10 ⁶	0.730	0.158	160	0.0110	0.0132	W42	
➤ W4205TJ520	5200	4205	45000	10.1 x 10 ⁶	0.850	0.190	150	0.0080	0.0085	W89	
➤ W4205TJ560	5600	4205	45000	10.1 x 10 ⁶	0.850	0.190	150	0.0080	0.0085	W89	
➤ W4205TJ600	6000	4205	45000	10.1 x 10 ⁶	0.850	0.190	150	0.0080	0.0085	W89	
➤ W4205TE520	5200	4205	45000	10.1 x 10 ⁶	0.850	0.190	150	0.0080	0.0085	W94	
➤ W4205TE560	5600	4205	45000	10.1 x 10 ⁶	0.850	0.190	150	0.0080	0.0085	W94	
➤ W4205TE600	6000	4205	45000	10.1 x 10 ⁶	0.850	0.190	150	0.0080	0.0085	W94	
W4534NC020	200	4534	40000	8.00 x 10 ⁶	0.765	0.052	190	0.0220	0.0260	W5	
W4534NC060	600	4534	40000	8.00 x 10 ⁶	0.765	0.052	190	0.0220	0.0260	W5	
W4693QK050	500	4693	31500	4.98 x 10 ⁶	0.904	0.057	180	0.0170	0.0207	WD2	
W4693QK080	800	4693	31500	4.98 x 10 ⁶	0.904	0.057	180	0.0170	0.0207	WD2	
W4693QR050	500	4693	31500	4.98 x 10 ⁶	0.904	0.057	180	0.0170	0.0207	WD7	
W4693QR080	800	4693	31500	4.98 x 10 ⁶	0.904	0.057	180	0.0170	0.0207	WD7	
W4713HL300	3000	4713	56000	15.70 x 10 ⁶	0.807	0.090	160	0.0120	0.0132	WD5	W52 Weight 2800 g
W4713HL350	3500	4713	56000	15.70 x 10 ⁶	0.807	0.090	160	0.0120	0.0132	WD5	
W4713HM300	3000	4713	56000	15.70 x 10 ⁶	0.807	0.090	160	0.0120	0.0132	WD6	
W4713HM350	3500	4713	56000	15.70 x 10 ⁶	0.807	0.090	160	0.0120	0.0132	WD6	
W4767MC180	1800	4755	38000	7.22 x 10 ⁶	0.827	0.083	175	0.0140	0.0160	W54	
W4767MC220	2200	4755	38000	7.22 x 10 ⁶	0.827	0.083	175	0.0140	0.0160	W54	
W5092ZC320	3200	5092	58000	16.80 x 10 ⁶	0.874	0.079	160	0.0110	0.0132	W7	W54 Weight 530 g
W5092ZC350	3500	5092	58000	16.80 x 10 ⁶	0.874	0.079	160	0.0110	0.0132	W7	
W5092ZD320	3200	5092	58000	16.80 x 10 ⁶	0.874	0.079	160	0.0110	0.0132	W42	
W5092ZD350	3500	5092	58000	16.80 x 10 ⁶	0.874	0.079	160	0.0110	0.0132	W42	

Rectifier Diodes

Capsule Types

Part No.	V _{RRM}	I _{FAV} T _K = 55°C	I _{FSM}	I ² t 10 ms ½ sine V _R - ≤ 60% V _{RRM}	V _{TO}	r _T	T _{JM}	R _{thJK}		Fig. No.	Package style Outlines on pages O-01...O-30
								180° Sine	120° Rect.		
➤ New	V	A	A	A ² s	V	mΩ	°C	K/W	K/W		
W5130MK240	2400	5130	42000	8.82 x 10 ⁶	0.910	0.070	175	0.0130	0.0149	WD3	
W5130MK280	2800	5130	42000	8.82 x 10 ⁶	0.910	0.070	175	0.0130	0.0149	WD3	
W5139TJ400	4000	5139	55000	15.10 x 10 ⁶	0.826	0.136	160	0.0080	0.0085	W89	
W5139TJ480	4800	5139	55000	15.10 x 10 ⁶	0.826	0.136	160	0.0080	0.0085	W89	
W5139TE400	4000	5139	55000	15.10 x 10 ⁶	0.826	0.136	160	0.0080	0.0085	W94	
W5139TE480	4800	5139	55000	15.10 x 10 ⁶	0.826	0.136	160	0.0080	0.0085	W94	
W5282ZC240	2400	5282	60000	18.00 x 10 ⁶	0.970	0.064	160	0.0110	0.0132	W7	W59 Weight 2000 g 
W5282ZC300	3000	5282	60000	18.00 x 10 ⁶	0.970	0.064	160	0.0110	0.0132	W7	
W5282ZD240	2400	5282	60000	18.00 x 10 ⁶	0.970	0.064	160	0.0110	0.0132	W42	
W5282ZD300	3000	5282	60000	18.00 x 10 ⁶	0.970	0.064	160	0.0110	0.0132	W42	
W5334MK200	2000	5334	46800	10.95 x 10 ⁶	0.892	0.069	180	0.0130	0.0149	WD3	
W5334MK220	2200	5334	46800	10.95 x 10 ⁶	0.892	0.069	180	0.0130	0.0149	WD3	
W5636MC120	1200	5636	46000	10.58 x 10 ⁶	0.698	0.059	175	0.0140	0.0160	W54	W89 Weight 1.3 kg 
W5636MC140	1400	5636	46000	10.58 x 10 ⁶	0.698	0.059	175	0.0140	0.0160	W54	
W5636MC150	1500	5636	46000	10.58 x 10 ⁶	0.698	0.059	175	0.0140	0.0160	W54	
W5696VC100	1000	5696	53000	14.00 x 10 ⁶	0.650	0.059	190	0.0160	0.0190	W6	
W5696VC140	1400	5696	53000	14.00 x 10 ⁶	0.650	0.059	190	0.0160	0.0190	W6	
W5696VF100	1000	5696	53000	14.00 x 10 ⁶	0.650	0.059	190	0.0160	0.0190	W43	
W5696VF140	1400	5696	53000	14.00 x 10 ⁶	0.650	0.059	190	0.0160	0.0190	W43	
W5838ZC180	1800	5838	64000	20.50 x 10 ⁶	0.800	0.074	175	0.0110	0.0132	W7	W94 Weight 1.6 kg 
W5838ZC220	2200	5838	64000	20.50 x 10 ⁶	0.800	0.074	175	0.0110	0.0132	W7	
W5838ZD180	1800	5838	64000	20.50 x 10 ⁶	0.800	0.074	175	0.0110	0.0132	W42	
W5838ZD220	2200	5838	64000	20.50 x 10 ⁶	0.800	0.074	175	0.0110	0.0132	W42	
W5984TJ360	3600	5984	62000	19.20 x 10 ⁶	0.758	0.097	160	0.0080	0.0085	W89	
W5984TJ400	4000	5984	62000	19.20 x 10 ⁶	0.758	0.097	160	0.0080	0.0085	W89	
W5984TE360	3600	5984	62000	19.20 x 10 ⁶	0.758	0.097	160	0.0080	0.0085	W94	
W5984TE400	4000	5984	62000	19.20 x 10 ⁶	0.758	0.097	160	0.0080	0.0085	W94	
W6262ZC200	2000	6262	67000	22.40 x 10 ⁶	0.730	0.064	175	0.0110	0.0132	W7	
W6262ZC240	2400	6262	67000	22.40 x 10 ⁶	0.730	0.064	175	0.0110	0.0132	W7	
W6262ZD200	2000	6262	67000	22.40 x 10 ⁶	0.730	0.064	175	0.0110	0.0132	W42	
W6262ZD240	2400	6262	67000	22.40 x 10 ⁶	0.730	0.064	175	0.0110	0.0132	W42	
W6908FC450	4500	6908	70000	24.50 x 10 ⁶	0.767	0.092	160	0.0065	0.0069	W52	WD3 Weight 270 g 
W6908FC500	5000	6908	70000	24.50 x 10 ⁶	0.767	0.092	160	0.0065	0.0069	W52	
W6908FD450	4500	6908	70000	24.50 x 10 ⁶	0.767	0.092	160	0.0065	0.0069	W59	
W6908FD500	5000	6908	70000	24.50 x 10 ⁶	0.767	0.092	160	0.0065	0.0069	W59	
➤ W7032DB020	200	8685	49500	13.60 x 10 ⁶	0.700	0.029	170	0.0100	0.0136	W49	
➤ W7032DB040	400	8685	49500	13.60 x 10 ⁶	0.700	0.029	170	0.0100	0.0136	W49	
W7045MC030	300	7045	54000	14.60 x 10 ⁶	0.793	0.033	190	0.0140	0.0160	W54	WD5 Weight 1200 g 
W7045MC060	600	7045	54000	14.60 x 10 ⁶	0.793	0.033	190	0.0140	0.0160	W54	
W8405ZC100	1000	8405	72000	25.90 x 10 ⁶	0.670	0.038	190	0.0110	0.0132	W7	
W8405ZC140	1400	8405	72000	25.90 x 10 ⁶	0.670	0.038	190	0.0110	0.0132	W7	
W8405ZD100	1000	8405	72000	25.90 x 10 ⁶	0.670	0.038	190	0.0110	0.0132	W42	
W8405ZD140	1400	8405	72000	25.90 x 10 ⁶	0.670	0.038	190	0.0110	0.0132	W42	
W8570TJ180	1800	8570	70200	24.60 x 10 ⁶	0.690	0.050	175	0.0080	0.0085	W89	WD6 Weight 1500 g 
W8570TJ220	2200	8570	70200	24.60 x 10 ⁶	0.690	0.050	175	0.0080	0.0085	W89	
W8570TE180	1800	8570	70200	24.60 x 10 ⁶	0.690	0.050	175	0.0080	0.0085	W94	
W8570TE220	2200	8570	70200	24.60 x 10 ⁶	0.690	0.050	175	0.0080	0.0085	W94	
W9830TJ120	1200	9830	72000	25.90 x 10 ⁶	0.670	0.043	190	0.0080	0.0085	W89	
W9830TJ150	1500	9830	72000	25.90 x 10 ⁶	0.670	0.043	190	0.0080	0.0085	W89	
W9830TE120	1200	9830	72000	25.90 x 10 ⁶	0.670	0.043	190	0.0080	0.0085	W94	
W9830TE150	1500	9830	72000	25.90 x 10 ⁶	0.670	0.043	190	0.0080	0.0085	W94	

* = Avalanche rated diode
‡ = Advanced data

For additional voltages, please contact the Chippenham Factory

WD7 Weight 200 g

Fast Recovery Diodes

Fast Recovery Diodes are an essential complement to any switching device and are more often than not the limiting factor in the design and performance of modern power converters. To address the needs of our customers, we have developed an unparalleled range of Fast Recovery Diodes. These diodes are available with blocking voltages up to 6.5 kV making them suitable for operation with DC link voltages up to 3.3 kV and average current ratings to 4 kA depending upon type. The devices utilise compression bonding along with both alloyed and floating silicon technologies to deliver robust devices that you can rely on in demanding applications. This range has been sub-classified as follows to aid appropriate device selection; Fast Recovery, Soft Recovery, Extra Fast Recovery Diodes and HP Sonic-FRDs.

Standard Fast Recovery Capsule Types







Fast Recovery Diodes: These parts are particularly suitable for use as anti-parallel diodes in Gate Turn-Off thyristors and Fast Thyristor inverters, diodes for choppers.

Part No.	V _{RRM} V	I _{FAV} T _K = 55°C A	I _{FSM} A	I ² t 10 ms ½ sine V _R - ≤ 60% V _{RRM} A ² s	Typ. Reverse Recovery T _J = 150°C				V _{T0} V	r _T mΩ	R _{thJK} d.c. 180° sine K/W	Fig. No.	Package style Outlines on pages O-01...O-30
					t _{rr} μs	Q _{rr} μC	@ I _{FM} A	@ -di _F /dt A/μs					
M0588LC400	4000	588	3955	78.2 x 10 ³	3.50	450	1000	60	2.320	1.770	0.0330	W4	W4
M0588LC450	4500	588	3955	78.2 x 10 ³	3.50	450	1000	60	2.320	1.770	0.0330	W4	
M0790YC200	2000	790	9000	405 x 10 ³	4.00	425	1000	60	1.272	0.584	0.0500	W2	W2 Weight 80 g
M0790YC250	2500	790	9000	405 x 10 ³	4.00	425	1000	60	1.272	0.584	0.0500	W2	
M0790YH200	2000	790	9000	405 x 10 ³	4.00	425	1000	60	1.272	0.584	0.0500	W3	W3 Weight 140 g
M0790YH250	2500	790	9000	405 x 10 ³	4.00	425	1000	60	1.272	0.584	0.0500	W3	
M0914LC200	2000	914	8500	361 x 10 ³	3.20	300	1000	60	1.768	0.653	0.0320	W4	W4
M0914LC250	2500	914	8500	361 x 10 ³	3.20	300	1000	60	1.768	0.653	0.0320	W4	
M1010NC400	4000	1010	9600	461 x 10 ³	3.20	1450	1000	200	1.700	1.030	0.0220	W5	W5
M1010NC450	4500	1010	9600	461 x 10 ³	3.20	1450	1000	200	1.700	1.030	0.0220	W5	
M1010ND400	4000	1010	9600	461 x 10 ³	3.20	1450	1000	200	1.700	1.030	0.0220	W37	W37 Weight 340 g
M1010ND450	4500	1010	9600	461 x 10 ³	3.20	1450	1000	200	1.700	1.030	0.0220	W37	
M1163NC400	4000	1163	10800	583 x 10 ³	6.40	1200	1000	60	1.500	0.770	0.0220	W5	W5
M1163NC450	4500	1163	10800	583 x 10 ³	6.40	1200	1000	60	1.500	0.770	0.0220	W5	
M1163ND400	4000	1163	10800	583 x 10 ³	6.40	1200	1000	60	1.500	0.770	0.0220	W37	W37 Weight 510 g
M1163ND450	4500	1163	10800	583 x 10 ³	6.40	1200	1000	60	1.500	0.770	0.0220	W37	
M1502NC200	2000	1502	17000	1.45 x 10 ⁶	3.50	350	1000	60	1.240	0.440	0.0220	W5	W4 Weight 340 g
M1502NC250	2500	1502	17000	1.45 x 10 ⁶	3.50	350	1000	60	1.240	0.440	0.0220	W5	
M1502ND200	2000	1502	17000	1.45 x 10 ⁶	3.50	350	1000	60	1.240	0.440	0.0220	W37	W37
M1502ND250	2500	1502	17000	1.45 x 10 ⁶	3.50	350	1000	60	1.240	0.440	0.0220	W37	
M1583VC400	4000	1583	24800	3.08 x 10 ⁶	5.00	2000	1000	200	1.693	0.525	0.0160	W6	W6
M1583VC450	4500	1583	24800	3.08 x 10 ⁶	5.00	2000	1000	200	1.693	0.525	0.0160	W6	
M1583VF400	4000	1583	24800	3.08 x 10 ⁶	5.00	2000	1000	200	1.693	0.525	0.0160	W43	W43
M1583VF450	4500	1583	24800	3.08 x 10 ⁶	5.00	2000	1000	200	1.693	0.525	0.0160	W43	
M1609NC200	2000	1609	17500	1.53 x 10 ⁶	3.20	800	1000	200	1.310	0.345	0.0220	W5	W5 Weight 510 g
M1609NC260	2600	1609	17500	1.53 x 10 ⁶	3.20	800	1000	200	1.310	0.345	0.0220	W5	
M1609ND200	2000	1609	17500	1.53 x 10 ⁶	3.20	800	1000	200	1.310	0.345	0.0220	W37	W37
M1609ND260	2600	1609	17500	1.53 x 10 ⁶	3.20	800	1000	200	1.310	0.345	0.0220	W37	
M2273VC300	3000	2273	28000	3.92 x 10 ⁶	8.50	2500	1000	60	1.239	0.244	0.0160	W6	W6
M2273VC360	3600	2273	28000	3.92 x 10 ⁶	8.50	2500	1000	60	1.239	0.244	0.0160	W6	
M2273VF300	3000	2273	28000	3.92 x 10 ⁶	8.50	2500	1000	60	1.239	0.244	0.0160	W43	W43 Weight 1000 g
M2273VF360	3600	2273	28000	3.92 x 10 ⁶	8.50	2500	1000	60	1.239	0.244	0.0160	W43	
M2408NC020	200	2408	24000	2.88 x 10 ⁶	1.90	250	1000	200	1.065	0.122	0.0220	W5	W5
M2408NC060	600	2408	24000	2.88 x 10 ⁶	1.90	250	1000	200	1.065	0.122	0.0220	W5	
M2408ND020	200	2408	24000	2.88 x 10 ⁶	1.90	250	1000	200	1.065	0.122	0.0220	W37	W37
M2408ND060	600	2408	24000	2.88 x 10 ⁶	1.90	250	1000	200	1.065	0.122	0.0220	W37	
M2639ZC420	4200	2639	27520	3.79 x 10 ⁶	8.50	2300	1000	60	1.380	0.290	0.0110	W7	W7 Weight 1700 g
M2639ZC450	4500	2639	27520	3.79 x 10 ⁶	8.50	2300	1000	60	1.380	0.290	0.0110	W7	
M2639ZD420	4200	2639	27520	3.79 x 10 ⁶	8.50	2300	1000	60	1.380	0.290	0.0110	W42	W42
M2639ZD450	4500	2639	27520	3.79 x 10 ⁶	8.50	2300	1000	60	1.380	0.290	0.0110	W42	
M2698ZC250	2500	2698	27800	3.86 x 10 ⁶	6.20	1200	1000	60	1.000	0.330	0.0110	W7	W7
M2698ZC280	2800	2698	27800	3.86 x 10 ⁶	6.20	1200	1000	60	1.000	0.330	0.0110	W7	
M2698ZC350	3500	2698	27800	3.86 x 10 ⁶	6.20	1200	1000	60	1.000	0.330	0.0110	W7	W37 Weight 510 g
M2698ZD250	2500	2698	27800	3.86 x 10 ⁶	6.20	1200	1000	60	1.000	0.330	0.0110	W42	
M2698ZD280	2800	2698	27800	3.86 x 10 ⁶	6.20	1200	1000	60	1.000	0.330	0.0110	W42	W42
M2698ZD350	3500	2698	27800	3.86 x 10 ⁶	6.20	1200	1000	60	1.000	0.330	0.0110	W42	
M2837VC180	1800	2837	31800	5.10 x 10 ⁶	7.00	2100	1000	60	0.900	0.170	0.0160	W6	W6
M2837VC250	2500	2837	31800	5.10 x 10 ⁶	7.00	2100	1000	60	0.900	0.170	0.0160	W6	
M2837VF180	1800	2837	31800	5.10 x 10 ⁶	7.00	2100	1000	60	0.900	0.170	0.0160	W43	W43 Weight 1200 g
M2837VF250	2500	2837	31800	5.10 x 10 ⁶	7.00	2100	1000	60	0.900	0.170	0.0160	W43	
M3770ZC200	2000	3770	44000	9.68 x 10 ⁶	7.00	2000	1000	60	1.190	0.118	0.0110	W7	W7
M3770ZC240	2400	3770	44000	9.68 x 10 ⁶	7.00	2000	1000	60	1.190	0.118	0.0110	W7	
M3770ZC300	3000	3770	44000	9.68 x 10 ⁶	7.00	2000	1000	60	1.190	0.118	0.0110	W7	W7
M3770ZD200	2000	3770	44000	9.68 x 10 ⁶	7.00	2000	1000	60	1.190	0.118	0.0110	W42	
M3770ZD240	2400	3770	44000	9.68 x 10 ⁶	7.00	2000	1000	60	1.190	0.118	0.0110	W42	W42 Weight 800 g
M3770ZD300	3000	3770	44000	9.68 x 10 ⁶	7.00	2000	1000	60	1.190	0.118	0.0110	W42	



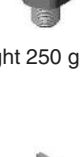

Soft Recovery Diodes

Our soft recovery diodes are available with a range of reverse recovery characteristics tailored to meet the requirements of both freewheeling and snubber applications. These devices are available with blocking voltages up to 6kV and average currents up to 2413A. 38mm to 75mm diameter silicon slices. These parts are particularly suitable where soft recovery is required, such as RCD snubbers, voltage clamping and snubberless applications.

Stud Types









Part No.	V _{RRM} V	I _{FAV} A T _C = 55°C	I _{FSM} A 10 ms ½ sine V _R ≤ 60% V _{RRM}	I ² t A ² s	Typ. Reverse Recovery				V _{TO}		T _{JM} °C	R _{thJC} d.c. 180° sine K/W	Fig. No.	Package style Outlines on pages O-01...O-30
					t _{rr} µs	Q _{rr} µC	T _{JM}		r _T mW	@T _{JM}				
							@ I _{FM} A	@ -di _F /dt A/µs						
M0130RL200	2000	130	2240	25.0 x 10 ³	2.60	430	1000	150	1.290	1.540	125	0.3000	W20	
M0130RL250	2500	130	2240	25.0 x 10 ³	2.60	430	1000	150	1.290	1.540	125	0.3000	W20	
M0130SL200	2000	130	2240	25.0 x 10 ³	2.60	430	1000	150	1.290	1.540	125	0.3000	W20	
M0130SL250	2500	130	2240	25.0 x 10 ³	2.60	430	1000	150	1.290	1.540	125	0.3000	W20	
M0130RM200	2000	130	2240	25.0 x 10 ³	2.60	430	1000	150	1.290	1.540	125	0.3000	W21	
M0130RM250	2500	130	2240	25.0 x 10 ³	2.60	430	1000	150	1.290	1.540	125	0.3000	W21	
M0130SM200	2000	130	2240	25.0 x 10 ³	2.60	430	1000	150	1.290	1.540	125	0.3000	W21	
M0130SM250	2500	130	2240	25.0 x 10 ³	2.60	430	1000	150	1.290	1.540	125	0.3000	W21	
M0139RL120	1200	139	2450	30.0 x 10 ³	1.00	125	1000	100	1.240	1.280	125	0.3000	W20	
M0139RL180	1800	139	2450	30.0 x 10 ³	1.00	125	1000	100	1.240	1.280	125	0.3000	W20	
M0139SL120	1200	139	2450	30.0 x 10 ³	1.00	125	1000	100	1.240	1.280	125	0.3000	W20	
M0139SL180	1800	139	2450	30.0 x 10 ³	1.00	125	1000	100	1.240	1.280	125	0.3000	W20	
M0139RM120	1200	139	2450	30.0 x 10 ³	1.00	125	1000	100	1.240	1.280	125	0.3000	W21	
M0139RM180	1800	139	2450	30.0 x 10 ³	1.00	125	1000	100	1.240	1.280	125	0.3000	W21	
M0139SM120	1200	139	2450	30.0 x 10 ³	1.00	125	1000	100	1.240	1.280	125	0.3000	W21	
M0139SM180	1800	139	2450	30.0 x 10 ³	1.00	125	1000	100	1.240	1.280	125	0.3000	W21	
M0268RC200	2000	268	4250	90.3 x 10 ³	2.80	300	1000	150	1.210	1.200	125	0.1300	W24	
M0268RC250	2500	268	4250	90.3 x 10 ³	2.80	300	1000	150	1.210	1.200	125	0.1300	W24	
M0268SC200	2000	268	4250	90.3 x 10 ³	2.80	300	1000	150	1.210	1.200	125	0.1300	W24	
M0268SC250	2500	268	4250	90.3 x 10 ³	2.80	300	1000	150	1.210	1.200	125	0.1300	W24	
M0268RJ200	2000	268	4250	90.3 x 10 ³	2.80	300	1000	150	1.210	1.200	125	0.1300	W22	
M0268RJ250	2500	268	4250	90.3 x 10 ³	2.80	300	1000	150	1.210	1.200	125	0.1300	W22	
M0268SJ200	2000	268	4250	90.3 x 10 ³	2.80	300	1000	150	1.210	1.200	125	0.1300	W22	
M0268SJ250	2500	268	4250	90.3 x 10 ³	2.80	300	1000	150	1.210	1.200	125	0.1300	W22	
M0280RC200	2000	280	4500	100 x 10 ³	2.80	610	1000	150	1.280	0.920	125	0.1300	W24	
M0280RC250	2500	280	4500	100 x 10 ³	2.80	610	1000	150	1.280	0.920	125	0.1300	W24	
M0280SC200	2000	280	4500	100 x 10 ³	2.80	610	1000	150	1.280	0.920	125	0.1300	W24	
M0280SC250	2500	280	4500	100 x 10 ³	2.80	610	1000	150	1.280	0.920	125	0.1300	W24	
M0280RJ200	2000	280	4500	100 x 10 ³	2.80	610	1000	150	1.280	0.920	125	0.1300	W22	
M0280RJ250	2500	280	4500	100 x 10 ³	2.80	610	1000	150	1.280	0.920	125	0.1300	W22	
M0280SJ200	2000	280	4500	100 x 10 ³	2.80	610	1000	150	1.280	0.920	125	0.1300	W22	
M0280SJ250	2500	280	4500	100 x 10 ³	2.80	610	1000	150	1.280	0.920	125	0.1300	W22	
M0334RC120	1200	334	4500	101 x 10 ³	3.50	290	550	40	1.000	0.740	125	0.1300	W24	
M0334RC200	2000	334	4500	101 x 10 ³	3.50	290	550	40	1.000	0.740	125	0.1300	W24	
M0334SC120	1200	334	4500	101 x 10 ³	3.50	290	550	40	1.000	0.740	125	0.1300	W24	
M0334SC200	2000	334	4500	101 x 10 ³	3.50	290	550	40	1.000	0.740	125	0.1300	W24	
M0334RJ120	1200	334	4500	101 x 10 ³	3.50	290	550	40	1.000	0.740	125	0.1300	W22	
M0334RJ200	2000	334	4500	101 x 10 ³	3.50	290	550	40	1.000	0.740	125	0.1300	W22	
M0334SJ120	1200	334	4500	101 x 10 ³	3.50	290	550	40	1.000	0.740	125	0.1300	W22	
M0334SJ200	2000	334	4500	101 x 10 ³	3.50	290	550	40	1.000	0.740	125	0.1300	W22	
M0336RA120	1200	336	4500	101 x 10 ³	3.00	140	550	40	1.020	0.700	125	0.1300	W23	
M0336RA140	1400	336	4500	101 x 10 ³	3.00	140	550	40	1.020	0.700	125	0.1300	W23	
M0336SA120	1200	336	4500	101 x 10 ³	3.00	140	550	40	1.020	0.700	125	0.1300	W23	
M0336SA140	1400	336	4500	101 x 10 ³	3.00	140	550	40	1.020	0.700	125	0.1300	W23	

Capsule Types

Part No.	V _{RRM} V	I _{FAV} A T _K = 55°C	I _{FSM} A	I ² t 10 ms ½ sine V _R - ≤ 60% V _{RRM} A ² s	Typ. Reverse Recovery				V _{TO} V	r _T mΩ	T _{JM} °C	R _{thJK} d.c. 180° sine K/W	Fig. No.	Package style Outlines on pages O-01...O-30
					t _{rr} μs	Q _{rr} μC	@ I _{FM} A	@ -di _F /dt A/μs						
M0225YH360	3600	225	2000	20 x 10 ³	3.00	220	550	40	1.900	4.160	150	0.1000	W3	
M0225YH450	4500	225	2000	20 x 10 ³	3.00	220	550	40	1.900	4.160	150	0.1000	W3	
M0310YH300	3000	310	4590	105 x 10 ³	2.80	275	1000	100	1.490	2.060	150	0.1000	W3	
M0310YH350	3500	310	4590	105 x 10 ³	2.80	275	1000	100	1.490	2.060	150	0.1000	W3	
M0347WC200	2000	347	4250	90.3 x 10 ³	2.80	210	550	40	1.210	1.200	125	0.0900	W1	
M0347WC250	2500	347	4250	90.3 x 10 ³	2.80	210	550	40	1.210	1.200	125	0.0900	W1	
M0358WC120	1200	358	2450	30 x 10 ³	1.40	125	1000	100	1.460	0.800	125	0.0900	W1	
M0358WC180	1800	358	2450	30 x 10 ³	1.40	125	1000	100	1.460	0.800	125	0.0900	W1	
M0367WC220	2200	367	4500	101 x 10 ³	3.30	300	550	40	1.280	0.920	125	0.0900	W1	
M0367WC280	2800	367	4500	101 x 10 ³	3.30	300	550	40	1.280	0.920	125	0.0900	W1	
M0371YH350	3500	371	4900	120 x 10 ³	3.20	1260	1000	200	1.050	1.650	150	0.1000	W3	
M0371YH450	4500	371	4900	120 x 10 ³	3.20	1260	1000	200	1.050	1.650	150	0.1000	W3	
M0433WC120	1200	433	4500	101 x 10 ³	3.50	270	550	40	1.000	0.740	125	0.0900	W1	
M0433WC160	1600	433	4500	101 x 10 ³	3.50	270	550	40	1.000	0.740	125	0.0900	W1	
M0433WC200	2000	433	4500	101 x 10 ³	3.50	270	550	40	1.000	0.740	125	0.0900	W1	
M0437WC080	800	437	4500	101 x 10 ³	3.00	75	550	40	1.020	0.700	125	0.0900	W1	
M0437WC140	1400	437	4500	101 x 10 ³	3.00	75	550	40	1.020	0.700	125	0.0900	W1	
M0659LC400	4000	659	7620	290 x 10 ³	4.20	800	1000	60	1.710	0.925	125	0.0330	W4	
M0659LC450	4500	659	7620	290 x 10 ³	4.20	800	1000	60	1.710	0.925	125	0.0330	W4	
M0710LC560	5600	710	8400	353 x 10 ³	4.00	2100	1000	200	1.450	0.875	125	0.0330	W4	
M0710LC600	6000	710	8400	353 x 10 ³	4.00	2100	1000	200	1.450	0.875	125	0.0330	W4	
M0736LC400	4000	736	9000	405 x 10 ³	5.20	1250	1000	60	1.606	0.700	125	0.0330	W4	
M0736LC450	4500	736	9000	405 x 10 ³	5.20	1250	1000	60	1.606	0.700	125	0.0330	W4	
M0759YC120	1200	759	9500	450 x 10 ³	2.00	80	550	50	1.130	0.380	125	0.0500	W2	
M0759YC160	1600	759	9500	450 x 10 ³	2.00	80	550	50	1.130	0.380	125	0.0500	W2	
M0759YH120	1200	759	9500	450 x 10 ³	2.00	80	550	50	1.130	0.380	125	0.0500	W3	
M0759YH160	1600	759	9500	450 x 10 ³	2.00	80	550	50	1.130	0.380	125	0.0500	W3	
M0859LC140	1400	859	10000	500 x 10 ³	3.00	280	800	50	1.170	0.320	125	0.0440	W4	
M0859LC160	1600	859	10000	500 x 10 ³	3.00	280	800	50	1.170	0.320	125	0.0440	W4	
M0863LC260	2600	863	10000	500 x 10 ³	4.80	950	1000	60	1.308	0.538	125	0.0330	W4	
M0863LC300	3000	863	10000	500 x 10 ³	4.80	950	1000	60	1.308	0.538	125	0.0330	W4	
M0863LC360	3600	863	10000	500 x 10 ³	4.80	950	1000	60	1.308	0.538	125	0.0330	W4	
M0872LC140	1400	872	10000	500 x 10 ³	4.00	700	1000	60	1.090	0.340	125	0.0440	W4	
M0872LC180	1800	872	10000	500 x 10 ³	4.00	700	1000	60	1.090	0.340	125	0.0440	W4	
M0872LC210	2100	872	10000	500 x 10 ³	4.00	700	1000	60	1.090	0.340	125	0.0440	W4	
M0955LC200	2000	955	11700	684 x 10 ³	3.40	500	1000	60	1.440	0.330	125	0.0330	W4	
M0955LC250	2500	955	11700	684 x 10 ³	3.40	500	1000	60	1.440	0.330	125	0.0330	W4	
M1022LC120	1200	1022	14000	980 x 10 ³	3.00	375	1000	60	1.240	0.330	125	0.0330	W4	
M1022LC160	1600	1022	14000	980 x 10 ³	3.00	375	1000	60	1.240	0.330	125	0.0330	W4	
M1022LC200	2000	1022	14000	980 x 10 ³	3.00	375	1000	60	1.240	0.330	125	0.0330	W4	
M1080LC100	1000	1080	13500	910 x 10 ³	1.90	85	1000	60	1.125	0.314	125	0.0330	W4	
M1080LC120	1200	1080	13500	910 x 10 ³	1.90	85	1000	60	1.125	0.314	125	0.0330	W4	

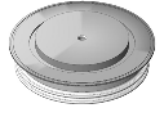
Soft Recovery Diodes

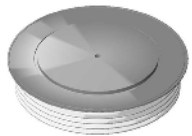
Capsule Types

Part No.	V _{RRM} V	I _{FAV} T _K = 55°C A	I _{FSM} A	I ² t 10 ms ½ sine V _R ≤ 60% V _{RRM} A ² s	Typ. Reverse Recovery				V _{TO} V	r _T mΩ	T _{JM} °C	R _{thJK} d.c. 180° sine K/W	Fig. No.	Package style Outlines on pages O-01...O-30	
					t _{rr} μs	Q _{rr} μC	@ I _{FM} A	@ -di _r /dt A/μs							
M1102NC500	5000	1102	13000	845 x 10 ³	5.50	3300	1000	200	1.360	0.557	125	0.0220	W5		
M1102NC600	6000	1102	13000	845 x 10 ³	5.50	3300	1000	200	1.360	0.557	125	0.0220	W5		
M1102ND500	5000	1102	13000	845 x 10 ³	5.50	3300	1000	200	1.360	0.557	125	0.0220	W37		
M1102ND600	6000	1102	13000	845 x 10 ³	5.50	3300	1000	200	1.360	0.557	125	0.0220	W37		
M1104NC400	4000	1104	13000	845 x 10 ³	6.00	2100	1000	60	1.370	0.553	125	0.0220	W5		
M1104NC450	4500	1104	13000	845 x 10 ³	6.00	2100	1000	60	1.370	0.553	125	0.0220	W5		
M1104ND400	4000	1104	13000	845 x 10 ³	6.00	2100	1000	60	1.370	0.553	125	0.0220	W37		
M1104ND450	4500	1104	13000	845 x 10 ³	6.00	2100	1000	60	1.370	0.553	125	0.0220	W37		
M1242NC260	2600	1242	16400	1.34 x 10 ⁶	6.00	1500	1000	60	1.270	0.420	125	0.0220	W5		
M1242NC360	3600	1242	16400	1.34 x 10 ⁶	6.00	1500	1000	60	1.270	0.420	125	0.0220	W5		
M1242ND260	2600	1242	16400	1.34 x 10 ⁶	6.00	1500	1000	60	1.270	0.420	125	0.0220	W37		
M1242ND360	3600	1242	16400	1.34 x 10 ⁶	6.00	1500	1000	60	1.270	0.420	125	0.0220	W37		
M1494NC160	1600	1494	19600	1.92 x 10 ⁶	3.90	815	1000	60	1.150	0.265	125	0.0220	W5		
M1494NC250	2500	1494	19600	1.92 x 10 ⁶	3.90	815	1000	60	1.150	0.265	125	0.0220	W5		
M1494ND160	1600	1494	19600	1.92 x 10 ⁶	3.90	815	1000	60	1.150	0.265	125	0.0220	W37		
M1494ND250	2500	1494	19600	1.92 x 10 ⁶	3.90	815	1000	60	1.150	0.265	125	0.0220	W37		
M1565VC360	3600	1565	19700	1.94 x 10 ⁶	5.00	2800	1000	200	1.090	0.360	125	0.0180	W6		
M1565VC400	4000	1565	19700	1.94 x 10 ⁶	5.00	2800	1000	200	1.090	0.360	125	0.0180	W6		
M1565VC450	4500	1565	19700	1.94 x 10 ⁶	5.00	2800	1000	200	1.090	0.360	125	0.0180	W6		
M1565VF360	3600	1565	19700	1.94 x 10 ⁶	5.00	2800	1000	200	1.090	0.360	125	0.0180	W43		
M1565VF400	4000	1565	19700	1.94 x 10 ⁶	5.00	2800	1000	200	1.090	0.360	125	0.0180	W43		
M1565VF450	4500	1565	19700	1.94 x 10 ⁶	5.00	2800	1000	200	1.090	0.360	125	0.0180	W43		
M1858NC120	1200	1858	25000	3.25 x 10 ⁶	2.50	120	1000	60	1.127	0.127	125	0.0220	W5		
M1858NC160	1600	1858	25000	3.25 x 10 ⁶	2.50	120	1000	60	1.127	0.127	125	0.0220	W5		
M1858ND120	1200	1858	25000	3.25 x 10 ⁶	2.50	120	1000	60	1.127	0.127	125	0.0220	W37		
M1858ND160	1600	1858	25000	3.25 x 10 ⁶	2.50	120	1000	60	1.127	0.127	125	0.0220	W37		
M2322ZC300	3000	2322	23000	2.64 x 10 ⁶	6.50	3200	1000	150	1.670	0.186	125	0.0110	W7		
M2322ZC400	4000	2322	23000	2.64 x 10 ⁶	6.50	3200	1000	150	1.670	0.186	125	0.0110	W7		
M2322ZD300	3000	2322	23000	2.64 x 10 ⁶	6.50	3200	1000	150	1.670	0.186	125	0.0110	W42		
M2322ZD400	4000	2322	23000	2.64 x 10 ⁶	6.50	3200	1000	150	1.670	0.186	125	0.0110	W42		
M2413VC200	2000	2413	32000	5.12 x 10 ⁶	5.00	2500	1000	200	1.090	0.121	125	0.0160	W6		
M2413VC250	2500	2413	32000	5.12 x 10 ⁶	5.00	2500	1000	200	1.090	0.121	125	0.0160	W6		
M2413VF200	2000	2413	32000	5.12 x 10 ⁶	5.00	2500	1000	200	1.090	0.121	125	0.0160	W43		
M2413VF250	2500	2413	32000	5.12 x 10 ⁶	5.00	2500	1000	200	1.090	0.121	125	0.0160	W43		
															W43 Weight 800 g

Extra Fast Recovery Diodes

These products are designed to offer the lowest practical values of reverse recovery current whilst offering wide safe operating area and high di/dt capability required by modern switching components.

Capsule Types

Part No.	V _{RRM} V	I _{FAV} T _K = 55°C A	I _{FSM} A	I ² t 10 ms ½ sine V _R - ≤ 60% V _{RRM} A ² s	Typ. Reverse Recovery					V _{T0} V	r _T mΩ	T _{JM} °C	R _{thJK} d.c. 180° sine K/W	Fig. No.
					I _{rm} A	t _{rr} μs	Q _{rr} μC	@ I _{FM} A	@ -di _F /dt A/μs					
F0240YC250	2500	240	3100	48.1 x 10 ³	40	2.00	100	550	40	2.271	2.853	150	0.1000	W2
F0240YC300	3000	240	3100	48.1 x 10 ³	40	2.00	100	550	40	2.271	2.853	150	0.1000	W2
F0240YH250	2500	240	3100	48.1 x 10 ³	40	2.00	100	550	40	2.271	2.853	150	0.1000	W3
F0240YH300	3000	240	3100	48.1 x 10 ³	40	2.00	100	550	40	2.271	2.853	150	0.1000	W3
F0300WC140	1400	240	2700	36.5 x 10 ³	530	3.00	70	550	40	1.760	2.210	125	0.0950	W1
F0300WC180	1800	240	2700	36.5 x 10 ³	530	3.00	70	550	40	1.760	2.210	125	0.0950	W1
F0800LC140	1400	775	7630	291 x 10 ³	380	1.10	200	1000	200	1.494	0.692	125	0.0320	W4
F0800LC180	1800	775	7630	291 x 10 ³	380	1.10	200	1000	200	1.494	0.692	125	0.0320	W4
F0900VC450	4500	816	10450	546 x 10 ³	120	3.80	230	1000	60	2.024	1.274	115	0.0160	W6
F0900VC520	5200	816	10450	546 x 10 ³	120	3.80	230	1000	60	2.024	1.274	115	0.0160	W6
F0900VF450	4500	816	10450	546 x 10 ³	120	3.80	230	1000	60	2.024	1.274	115	0.0160	W43
F0900VF520	5200	816	10450	546 x 10 ³	120	3.80	230	1000	60	2.024	1.274	115	0.0160	W43
F1000LC080	800	826	8500	361 x 10 ³	320	1.60	250	1000	800	1.530	0.547	125	0.0320	W4
F1000LC120	1200	826	8500	361 x 10 ³	320	1.60	250	1000	800	1.530	0.547	125	0.0320	W4
F1300NC45P	4500	1346	20800	2.16 x 10 ⁶	470	4.30	2150	1000	200	1.569	0.318	140	0.0240	W5
F1300NC50P	5000	1346	20800	2.16 x 10 ⁶	470	4.30	2150	1000	200	1.569	0.318	140	0.0240	W5
F1300NC55P	5500	1346	20800	2.16 x 10 ⁶	470	4.30	2150	1000	200	1.569	0.318	140	0.0240	W5
F1300NH45P	4500	1346	20800	2.16 x 10 ⁶	470	4.30	2150	1000	200	1.569	0.318	140	0.0240	W47
F1300NH50P	5000	1346	20800	2.16 x 10 ⁶	470	4.30	2150	1000	200	1.569	0.318	140	0.0240	W47
F1300NH55P	5500	1346	20800	2.16 x 10 ⁶	470	4.30	2150	1000	200	1.569	0.318	140	0.0240	W47
F1400NC140	1400	1093	17250	1.49 x 10 ⁶	800	1.50	1000	1400	1000	1.618	0.388	125	0.0240	W5
F1400NC180	1800	1093	17250	1.49 x 10 ⁶	800	1.50	1000	1400	1000	1.618	0.388	125	0.0240	W5
F1400ND140	1400	1093	17250	1.49 x 10 ⁶	800	1.50	1000	1400	1000	1.618	0.388	125	0.0240	W37
F1400ND180	1800	1093	17250	1.49 x 10 ⁶	800	1.50	1000	1400	1000	1.618	0.388	125	0.0240	W37
F1500NC200	2000	1054	13750	950 x 10 ³	1065	1.50	1500	1500	2000	1.372	0.535	125	0.0240	W5
F1500NC250	2500	1054	13750	950 x 10 ³	1065	1.50	1500	1500	2000	1.372	0.535	125	0.0240	W5
F1600NC080	800	1326	20000	2.0 x 10 ⁶	480	2.30	700	1600	800	1.320	0.268	125	0.0240	W5
F1600NC120	1200	1326	20000	2.0 x 10 ⁶	480	2.30	700	1600	800	1.320	0.268	125	0.0240	W5

Outlines on pages O-01...O-30

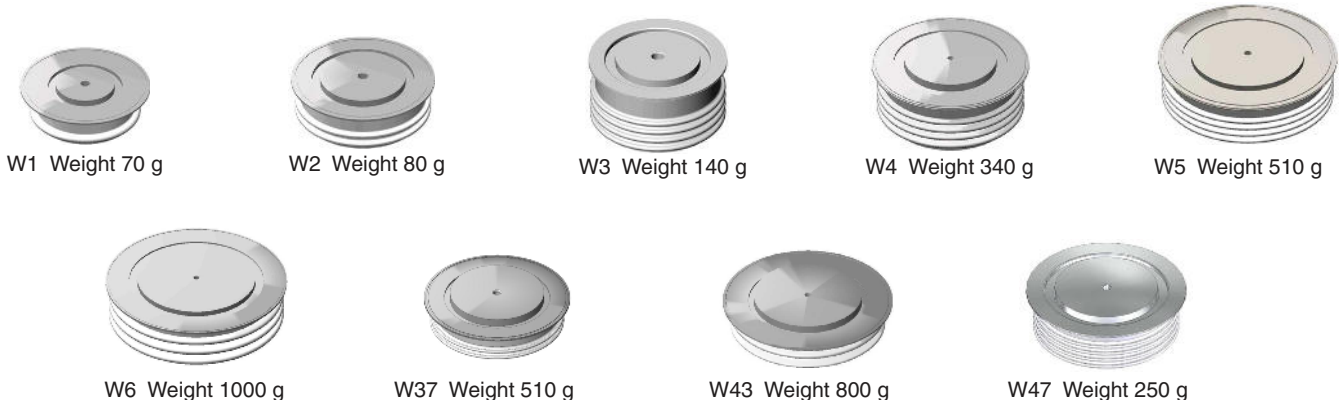

High Power Sonic FRD's

Introducing a world-leading class of ultra fast and ultra soft recovery diode available from 1.4kV to 6.5kV in current ratings from 170 to 4000A. These diodes incorporate a unique manufacturing process and lifetime control to offer a class leading trade-off between conduction and switching losses. The wide safe operating area (SOA) makes them ideal as freewheeling diodes for snubberless IGBT and IGCT applications. In fact, any application which requires a fast, low loss diode. For example: traction, medium voltage drives, induction heating and pulsed power applications.

Capsule Types

Part No.	V _{RRM}	I _{FAV}	I _{FSM}	I ² t	Typ. Reverse Recovery					V _{T0}	r _T	T _{JM}	R _{thJK}	Fig. No.
					T _K = 55°C	10 ms ½ sine V _R ≤ 60% V _{RRM}	I _{rm}	t _{rr}	Q _{rr}					
➤ New	V	A	A	A ² s	A	μs	μC	A	A/μs	V	mΩ	°C	K/W	
E0170YH40C	4000	210	1390	9.67 x 10 ³	125	1.60	280	170	300	2.580	7.170	150	0.073	W3
E0170YH45C	4500	210	1390	9.67 x 10 ³	125	1.60	280	170	300	2.580	7.170	150	0.073	W3
E0280YH20C	2000	350	2330	27.1 x 10 ³	380	1.30	500	280	1000	1.410	2.600	150	0.073	W3
E0280YH25C	2500	350	2330	27.1 x 10 ³	380	1.30	500	280	1000	1.410	2.600	150	0.073	W3
➤ E0330MF65F	6500	277	2790	38.9 x 10 ³	400	1.20	550	330	1000	1.890	5.800	125	0.043	W99
E0460QC40C	4000	532	5750	165 x 10 ³	450	1.00	900	500	1500	2.150	3.040	150	0.029	W68
E0460QC45C	4500	532	5750	165 x 10 ³	450	1.00	900	500	1500	2.150	3.040	150	0.029	W68
E0660NC40C	4000	765	7318	268 x 10 ³	600	1.50	960	660	1000	2.000	2.236	150	0.020	W5
E0660NC45C	4500	765	7318	268 x 10 ³	600	1.50	960	660	1000	2.000	2.236	150	0.020	W5
E0660NH40C	4000	765	7318	268 x 10 ³	600	1.50	960	660	1000	2.000	2.236	150	0.020	W47
E0660NH45C	4500	765	7318	268 x 10 ³	600	1.50	960	660	1000	2.000	2.236	150	0.020	W47
➤ E0770HF65F	6500	632	6418	206 x 10 ³	900	1.20	1200	770	2000	1.890	2.538	125	0.019	W100
E0800QC20C	2000	960	10700	575 x 10 ³	720	1.60	1420	800	1500	1.410	0.839	150	0.029	W68
E0800QC25C	2500	960	10700	575 x 10 ³	720	1.60	1420	800	1500	1.410	0.839	150	0.029	W68
➤ E1000TF65F	6500	915	10400	537 x 10 ³	650	1.80	1700	1000	1700	2.291	1.185	125	0.015	W97
E1200NC20C	2000	1338	13300	884 x 10 ³	650	4.00	2000	1200	1500	1.305	0.678	150	0.020	W5
E1200NC25C	2500	1338	13300	884 x 10 ³	650	4.00	2000	1200	1500	1.305	0.678	150	0.020	W5
E1200NH20C	2000	1338	13300	884 x 10 ³	650	4.00	2000	1200	1500	1.305	0.678	150	0.020	W47
E1200NH25C	2500	1338	13300	884 x 10 ³	650	4.00	2000	1200	1500	1.305	0.678	150	0.020	W47
E1300VF40C	4000	1350	14000	1.08 x 10 ⁶	1500	1.10	2150	1300	3000	2.310	0.930	150	0.013	W43
E1300VF45C	4500	1350	14000	1.08 x 10 ⁶	1500	1.10	2150	1300	3000	2.310	0.930	150	0.013	W43
➤ E1375EF65F	6500	1125	12180	742 x 10 ³	1600	1.10	2100	1375	3500	1.890	1.423	125	0.011	W101
E1500NC36P	3600	1280	17050	1.45 x 10 ⁶	1425	2.80	2750	1000	1000	1.417	0.656	140	0.019	W5
E1500NC42P	4200	1280	17050	1.45 x 10 ⁶	1425	2.80	2750	1000	1000	1.417	0.656	140	0.019	W5
E1500NC48P	4800	1280	17050	1.45 x 10 ⁶	1425	2.80	2750	1000	1000	1.417	0.656	140	0.019	W5
E1500NH36P	3600	1280	17050	1.45 x 10 ⁶	1425	2.80	2750	1000	1000	1.417	0.656	140	0.019	W47
E1500NH42P	4200	1280	17050	1.45 x 10 ⁶	1425	2.80	2750	1000	1000	1.417	0.656	140	0.019	W47
E1500NH48P	4800	1280	17050	1.45 x 10 ⁶	1425	2.80	2750	1000	1000	1.417	0.656	140	0.019	W47
➤ E2060FF65F	6500	1690	20090	2.02 x 10 ⁶	2050	1.10	2800	2060	4500	1.890	0.951	125	0.007	W105
E2250VF20C	2000	2426	25200	3.17 x 10 ⁶	1650	1.90	3700	2250	2500	1.510	0.250	150	0.013	W43
E2250VF25C	2500	2426	25200	3.17 x 10 ⁶	1650	1.90	3700	2250	2500	1.510	0.250	150	0.013	W43
E2400TC40C	4000	2233	25600	3.29 x 10 ⁶	2050	1.50	3700	2400	3000	2.060	0.590	150	0.008	W28
E2400TC45C	4500	2233	25600	3.29 x 10 ⁶	2050	1.50	3700	2400	3000	2.060	0.590	150	0.008	W28
E4000TC20C	2000	4080	50000	12.5 x 10 ⁶	2480	2.50	6700	4000	3500	1.406	0.149	150	0.008	W28
E4000TC25C	2500	4080	50000	12.5 x 10 ⁶	2480	2.50	6700	4000	3500	1.406	0.149	150	0.008	W28

Outlines on pages O-01...O-30



W3 Weight 140 g



W28 Weight 1230 g

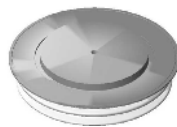

W43 Weight 800 g



W47 Weight 250 g



W5 Weight 510 g

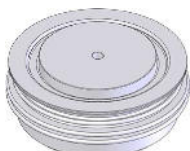

W68 Weight 300 g

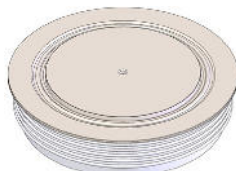

W97 Weight 1000 g



W100 Weight 600 g

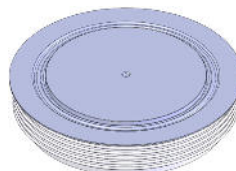

W101 Weight 1500 g

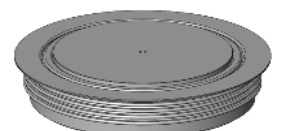

W105 Weight 2300 g

Phase Control Thyristors

IXYS UK provides one of the most comprehensive ranges of standard phase control thyristors in the industry. Devices with voltage ranges from 400V to 6500V are available, making them suitable for applications with line voltages from 230V to over 1000V (higher voltage applications are now served by our range of Medium Voltage Thyristors). IXYS UK Westcode Ltd. is a leading supplier of phase control products into demanding markets such as industrial DC drives, controlled rectifiers, marine/rail propulsion systems, wind power converters, electrochemical power supplies and soft starters. These devices are optimised to give low conduction losses and are primarily intended for applications with line frequencies up to 400Hz.

The Wespac outline (WPxx) is a new concept in phase control thyristors for applications requiring devices rated to 2200V. It gives the maximum power rating for weight and volume without compromising on quality and reliability. It also gives the maximum current rating and lowest thermal resistance for the package size.

The newest additions to IXYS UK's phase control thyristor range are the 83mm diameter Si capsules. These devices are of alloyed construction offering better thermal and electromechanical capability and are available with current ratings up to 4340A and voltage ratings up to 4500V.

Stud Types

Part No.	V_{DRM}	I_{TAV}	I_{TSM}	I^2t	V_{T0}	r_T	T_{JM}	R_{thJC}		Fig. No.
	V_{RRM}	$T_C = 55^\circ C$	10 ms $\frac{1}{2}$ sine $V_R - \leq 60\% V_{RRM}$		@ T_{JM}			d.c.	120° Rect.	
	V	A	A	A ² s	V	mΩ		K/W	K/W	
N0180SH120	1200	180	2450	30.0×10^3	0.900	1.790	125	0.2300	0.2800	W17
N0180SH160	1600	180	2450	30.0×10^3	0.900	1.790	125	0.2300	0.2800	W17
N0335SC120	1200	335	4650	108×10^3	0.920	0.990	125	0.1200	0.1400	W18
N0335SC160	1600	335	4650	108×10^3	0.920	0.990	125	0.1200	0.1400	W18
N0416SC040	400	416	6000	180×10^3	0.850	0.535	125	0.1200	0.1400	W18
N0416SC080	800	416	6000	180×10^3	0.850	0.535	125	0.1200	0.1400	W18

Outlines on pages
O-01...O-30

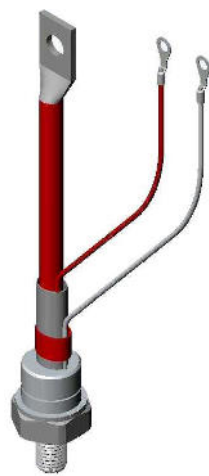



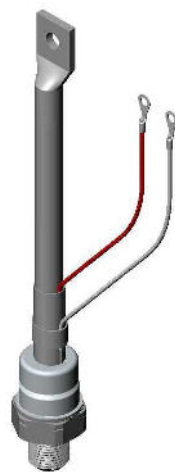









W17 Weight 130 g



W18 Weight 280 g

Phase Control Thyristors







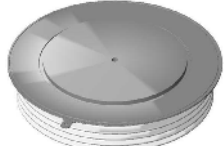
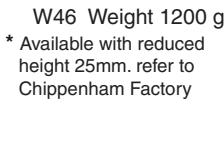

Capsule Types

Part No.	V_{DRM}	I_{TAV}	I_{TSM}	I^2t 10 ms ½ sine $V_R \leq 60\% V_{RRM}$	V_{TO}	r_T	T_{JM}	R_{thJK}		Fig. No.	Package style Outlines on pages O-01...O-30
	V_{RRM}	$T_K = 55^\circ C$						180° Sine	120° Rect.		
	V	A	A	A ² s	V	mΩ	°C	K/W	K/W		
N0465WN140	1400	465	4500	101 x 10 ³	0.900	0.850	125	0.0800	0.0912	W90	
N0465WN160	1600	465	4500	101 x 10 ³	0.900	0.850	125	0.0800	0.0912	W90	
N0530YN220	2200	530	6300	198 x 10 ³	1.100	1.250	125	0.0480	0.0494	W91	
N0530YN250	2500	530	6300	198 x 10 ³	1.100	1.250	125	0.0480	0.0494	W91	
N0616LC400	4000	616	5250	138 x 10 ³	1.220	1.530	125	0.0320	0.0393	W10	
N0616LC450	4500	616	5250	138 x 10 ³	1.220	1.530	125	0.0320	0.0393	W10	
N0634LC380	3800	634	7000	245 x 10 ³	1.100	1.500	125	0.0320	0.0393	W10	
N0634LC420	4200	634	7000	245 x 10 ³	1.100	1.500	125	0.0320	0.0393	W10	
N0646LC300	3000	646	5700	162 x 10 ³	1.210	1.360	125	0.0320	0.0393	W10	
N0646LC360	3600	646	5700	162 x 10 ³	1.210	1.360	125	0.0320	0.0393	W10	
N0795YN140	1400	795	9450	444 x 10 ³	0.950	0.450	125	0.0480	0.0494	W91	
N0795YN180	1800	795	9450	444 x 10 ³	0.950	0.450	125	0.0480	0.0494	W91	
N0882NC400	4000	882	7700	296 x 10 ³	1.300	0.920	125	0.0240	0.0273	W11	
N0882NC450	4500	882	7700	296 x 10 ³	1.300	0.920	125	0.0240	0.0273	W11	
N0910LC200	2000	910	9200	423 x 10 ³	1.040	0.606	125	0.0320	0.0393	W10	
N0910LC260	2600	910	9200	423 x 10 ³	1.040	0.606	125	0.0320	0.0393	W10	
N1010NC300	3000	1010	12100	732 x 10 ³	1.170	0.687	125	0.0240	0.0273	W11	
N1010NC380	3800	1010	12100	732 x 10 ³	1.170	0.687	125	0.0240	0.0273	W11	
N1075LN180	1800	1240	15750	1.24 x 10 ⁶	0.850	0.320	130	0.0330	0.0371	W92	
N1132NC300	3000	1132	14300	1.02 x 10 ⁶	1.150	0.510	125	0.0240	0.0271	W11	
N1132NC320	3200	1132	14300	1.02 x 10 ⁶	1.150	0.510	125	0.0240	0.0271	W11	
N1140LN140	1400	1315	17500	1.53 x 10 ⁶	0.820	0.280	130	0.0330	0.0371	W92	
N1159NC380	3800	1159	14500	1.05 x 10 ⁶	1.100	0.574	125	0.0220	0.0255	W11	
N1159NC420	4200	1159	14500	1.05 x 10 ⁶	1.100	0.574	125	0.0220	0.0255	W11	
N1174JK200	2000	1174	13200	870 x 10 ³	1.000	0.416	125	0.0270	0.0314	WP1	
N1174JK220	2200	1174	13200	870 x 10 ³	1.000	0.416	125	0.0270	0.0314	WP1	
N1263JK160	1600	1263	15000	1.13 x 10 ⁶	1.015	0.332	125	0.0270	0.0314	WP1	
N1263JK180	1800	1263	15000	1.13 x 10 ⁶	1.015	0.332	125	0.0270	0.0314	WP1	
N1351VC400 *	4000	1351	17500	1.53 x 10 ⁶	1.200	0.553	125	0.0170	0.0206	W12	
N1351VC450 *	4500	1351	17500	1.53 x 10 ⁶	1.200	0.553	125	0.0170	0.0206	W12	
N1351VF400 *	4000	1351	17500	1.53 x 10 ⁶	1.200	0.553	125	0.0170	0.0206	W62	
N1351VF450 *	4500	1351	17500	1.53 x 10 ⁶	1.200	0.553	125	0.0170	0.0206	W62	
N1366JK080	800	1366	15900	1.26 x 10 ⁶	0.985	0.270	125	0.0270	0.0314	WP1	
N1366JK120	1200	1366	15900	1.26 x 10 ⁶	0.985	0.270	125	0.0270	0.0314	WP1	
N1366JK140	1400	1366	15900	1.26 x 10 ⁶	0.985	0.270	125	0.0270	0.0314	WP1	
N1449QL200	2000	1410	17300	1.50 x 10 ⁶	1.060	0.317	125	0.0230	0.0272	WP6	
N1449QL220	2200	1410	17300	1.50 x 10 ⁶	1.060	0.317	125	0.0230	0.0272	WP6	
N1467NC200	2000	1467	21500	2.31 x 10 ⁶	1.000	0.272	125	0.0240	0.0271	W11	
N1467NC260	2600	1467	21500	2.31 x 10 ⁶	1.000	0.272	125	0.0240	0.0271	W11	
N1547NC160	1600	1547	23300	2.71 x 10 ⁶	0.920	0.252	125	0.0240	0.0271	W11	
N1547NC200	2000	1547	23300	2.71 x 10 ⁶	0.920	0.252	125	0.0240	0.0271	W11	
N1581QL160	1600	1535	19100	1.82 x 10 ⁶	1.022	0.253	125	0.0230	0.0270	WP6	
N1581QL180	1800	1535	19100	1.82 x 10 ⁶	1.022	0.253	125	0.0230	0.0270	WP6	
N1651QK200	2000	1651	17300	1.50 x 10 ⁶	1.060	0.317	125	0.0180	0.0217	WP2	
N1651QK220	2200	1651	17300	1.50 x 10 ⁶	1.060	0.317	125	0.0180	0.0217	WP2	
N1661VC300 *	3000	1661	23000	2.65 x 10 ⁶	1.040	0.350	125	0.0170	0.0206	W12	
N1661VC360 *	3600	1661	23000	2.65 x 10 ⁶	1.040	0.350	125	0.0170	0.0206	W12	
N1661VF300 *	3000	1661	23000	2.65 x 10 ⁶	1.040	0.350	125	0.0170	0.0206	W62	
N1661VF360 *	3600	1661	23000	2.65 x 10 ⁶	1.040	0.350	125	0.0170	0.0206	W62	

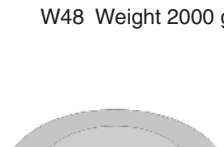
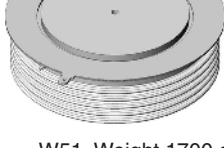
* = Please consult factory for new products to be introduced 2015



Phase Control Thyristors

Capsule Types

Part No. ○ Not for new design ➤ New	V_{DRM} V_{RRM}	I_{TAV} $T_K = 55^\circ\text{C}$	I_{TSM} 10 ms $\frac{1}{2}$ sine $V_R \leq 60\% V_{RRM}$	I^2t A ² s	V_{TO} @ T_{JM}	r_T mΩ	T_{JM} °C	R_{thJK}		Fig. No.	Package style Outlines on pages O-01...O-30
	V	A	A	A ² s	V	mΩ	°C	180° Sine K/W	120° Rect. K/W		
N1718NC120	1200	1718	27200	3.70 x 10 ⁶	0.979	0.169	125	0.0240	0.0271	W11	
N1718NC180	1800	1718	27200	3.70 x 10 ⁶	0.979	0.169	125	0.0240	0.0271	W11	
N1718NC200	2000	1718	27200	3.70 x 10 ⁶	0.979	0.169	125	0.0240	0.0271	W11	
➤ N1725MC320	3200	1725	20000	2.00 x 10 ⁶	1.020	0.396	125	0.015	0.0165	W70	
➤ N1725MC360	3600	1725	20000	2.00 x 10 ⁶	1.020	0.396	125	0.015	0.0165	W70	
N1802NC120	1200	1802	29600	4.38 x 10 ⁶	0.855	0.171	125	0.0240	0.0271	W11	
N1802NC160	1600	1802	29600	4.38 x 10 ⁶	0.855	0.171	125	0.0240	0.0271	W11	
N1806QK160	1600	1806	19100	1.82 x 10 ⁶	1.022	0.253	125	0.0180	0.0217	WP2	* Available with reduced height 25mm. refer to Chippenham Factory
N1806QK180	1800	1806	19100	1.82 x 10 ⁶	1.022	0.253	125	0.0180	0.0217	WP2	
N1817QL080	800	1760	22000	2.42 x 10 ⁶	0.955	0.177	125	0.0230	0.0272	WP6	
N1817QL120	1200	1760	22000	2.42 x 10 ⁶	0.955	0.177	125	0.0230	0.0272	WP6	
N1817QL140	1400	1760	22000	2.42 x 10 ⁶	0.955	0.177	125	0.0230	0.0272	WP6	
N2015ML200	2000	2015	32400	5.25 x 10 ⁶	0.883	0.210	125	0.0180	0.0201	WP5	
N2015ML220	2200	2015	32400	5.25 x 10 ⁶	0.883	0.210	125	0.0180	0.0201	WP5	
➤ N2055MC260	2600	2055	24500	3.00 x 10 ⁶	1.000	0.250	125	0.015	0.0165	W70	
➤ N2055MC280	2800	2055	24500	3.00 x 10 ⁶	1.000	0.250	125	0.015	0.0165	W70	
N2083QK080	800	2083	22000	2.42 x 10 ⁶	0.955	0.177	125	0.0180	0.0217	WP2	W48 Weight 2000 g
N2083QK120	1200	2083	22000	2.42 x 10 ⁶	0.955	0.177	125	0.0180	0.0217	WP2	
N2083QK140	1400	2083	22000	2.42 x 10 ⁶	0.955	0.177	125	0.0180	0.0217	WP2	
N2086NC060	600	2086	35000	6.13 x 10 ⁶	0.840	0.108	125	0.0240	0.0271	W11	
N2086NC100	1000	2086	35000	6.13 x 10 ⁶	0.840	0.108	125	0.0240	0.0271	W11	
N2154JK020	200	2154	22700	2.58 x 10 ⁶	0.890	0.107	140	0.0270	0.0314	WP1	
N2154JK040	400	2154	22700	2.58 x 10 ⁶	0.890	0.107	140	0.0270	0.0314	WP1	
N2154JK060	600	2154	22700	2.58 x 10 ⁶	0.890	0.107	140	0.0270	0.0314	WP1	
N2172ZC400	4000	2172	28000	3.92 x 10 ⁶	1.350	0.294	125	0.0110	0.0120	W13	W51 Weight 1700 g
N2172ZC450	4500	2172	28000	3.92 x 10 ⁶	1.350	0.294	125	0.0110	0.0120	W13	
N2172ZD400	4000	2172	28000	3.92 x 10 ⁶	1.350	0.294	125	0.0110	0.0120	W46	
N2172ZD450	4500	2172	28000	3.92 x 10 ⁶	1.350	0.294	125	0.0110	0.0120	W46	
N2191ML160	1600	2191	34500	5.95 x 10 ⁶	0.940	0.154	125	0.0180	0.0201	WP5	
N2191ML180	1800	2191	34500	5.95 x 10 ⁶	0.940	0.154	125	0.0180	0.0201	WP5	
○ N2293VC180	1800	2293	33800	5.7 x 10 ⁶	0.956	0.148	125	0.0170	0.0206	W12	W62 Weight 1000 g
○ N2293VC220	2200	2293	33800	5.7 x 10 ⁶	0.956	0.148	125	0.0170	0.0206	W12	
○ N2293VF180	1800	2293	33800	5.7 x 10 ⁶	0.956	0.148	125	0.0170	0.0206	W62	
○ N2293VF220	2200	2293	33800	5.7 x 10 ⁶	0.956	0.148	125	0.0170	0.0206	W62	
N2367MK200	2000	2367	32400	5.25 x 10 ⁶	0.883	0.210	125	0.0140	0.0157	WP3	
N2367MK220	2200	2367	32400	5.25 x 10 ⁶	0.883	0.210	125	0.0140	0.0157	WP3	
N2418ZC300	3000	2418	30000	4.50 x 10 ⁶	1.160	0.246	125	0.0110	0.0119	W13	W70 Weight 550 g
N2418ZC360	3600	2418	30000	4.50 x 10 ⁶	1.160	0.246	125	0.0110	0.0119	W13	
N2418ZD300	3000	2418	30000	4.50 x 10 ⁶	1.160	0.246	125	0.0110	0.0119	W46	
N2418ZD360	3600	2418	30000	4.50 x 10 ⁶	1.160	0.246	125	0.0110	0.0119	W46	
○ N2500VC120	1200	2500	37000	6.85 x 10 ⁶	0.880	0.124	125	0.0170	0.0206	W12	
○ N2500VC160	1600	2500	37000	6.85 x 10 ⁶	0.880	0.124	125	0.0170	0.0206	W12	
○ N2500VF120	1200	2500	37000	6.85 x 10 ⁶	0.880	0.124	125	0.0170	0.0206	W62	
○ N2500VF160	1600	2500	37000	6.85 x 10 ⁶	0.880	0.124	125	0.0170	0.0206	W62	
N2520ML080	800	2520	38200	7.30 x 10 ⁶	0.980	0.090	125	0.0180	0.0201	WP5	W79 Weight 890 g
N2520ML120	1200	2520	38200	7.30 x 10 ⁶	0.980	0.090	125	0.0180	0.0201	WP5	
N2520ML140	1400	2520	38200	7.30 x 10 ⁶	0.980	0.090	125	0.0180	0.0201	WP5	





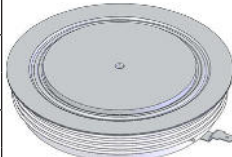
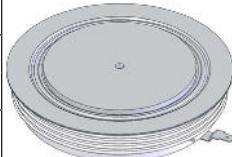
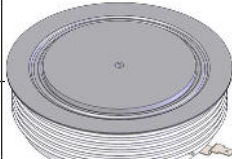
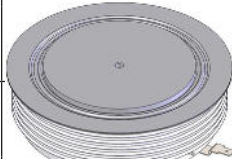
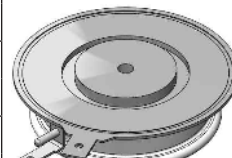
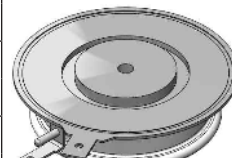
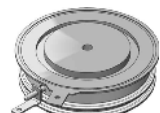
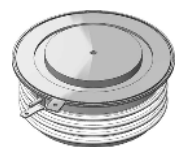

Phase Control Thyristors

Capsule Types

Part No.	V_{DRM}	I_{TAV}	I_{TSM}	I^2t 10 ms ½ sine $V_R - \leq 60\% V_{RRM}$	V_{T0}	r_T	T_{JM}	R_{thJK}		Fig. No.	Package style Outlines on pages O-01...O-30
	V_{RRM}	$T_K = 55^\circ C$						180° Sine	120° Rect.		
➤ New	V	A	A	A ² s	V	mΩ	°C	K/W	K/W		
N2543ZC240	2400	2543	32000	5.12 x 10 ⁶	0.780	0.274	125	0.0110	0.0119	W13	
N2543ZC300	3000	2543	32000	5.12 x 10 ⁶	0.780	0.274	125	0.0110	0.0119	W13	
N2543ZD240	2400	2543	32000	5.12 x 10 ⁶	0.780	0.274	125	0.0110	0.0119	W46	
N2543ZD300	3000	2543	32000	5.12 x 10 ⁶	0.780	0.274	125	0.0110	0.0119	W46	
N2593MK160	1600	2593	34500	5.95 x 10 ⁶	0.940	0.154	125	0.0140	0.0157	WP3	
N2593MK180	1800	2593	34500	5.95 x 10 ⁶	0.940	0.154	125	0.0140	0.0157	WP3	
N2600MC160	1600	2600	30000	4.50 x 10 ⁶	0.950	0.130	125	0.015	0.0165	W70	W80 Weight 1200 g
N2600MC180	1800	2600	30000	4.50 x 10 ⁶	0.950	0.130	125	0.015	0.0165	W70	
N2825TE400	4000	2825	36900	6.81 x 10 ⁶	1.210	0.270	125	0.0080	0.0085	W82	
N2825TE450	4500	2825	36900	6.81 x 10 ⁶	1.210	0.270	125	0.0080	0.0085	W82	
N2825TJ400	4000	2825	36900	6.81 x 10 ⁶	1.210	0.270	125	0.0080	0.0085	W81	
N2825TJ450	4500	2825	36900	6.81 x 10 ⁶	1.210	0.270	125	0.0080	0.0085	W81	
➤ N2830HE260	2600	2830	36000	6.48 x 10 ⁶	0.930	0.150	125	0.0125	0.0138	W80	
➤ N2830HE280	2800	2830	36000	6.48 x 10 ⁶	0.930	0.150	125	0.0125	0.0138	W80	
N2900QL020	200	2900	28000	3.92 x 10 ⁶	0.850	0.080	150	0.0230	0.0272	WP6	W81 Weight 1200 g
N2900QL040	400	2900	28000	3.92 x 10 ⁶	0.850	0.080	150	0.0230	0.0272	WP6	
N2900QL060	600	2900	28000	3.92 x 10 ⁶	0.850	0.080	150	0.0230	0.0272	WP6	
N3012ZC200	2000	3012	45100	10.2 x 10 ⁶	0.920	0.160	125	0.0110	0.0119	W13	
N3012ZC260	2600	3012	45100	10.2 x 10 ⁶	0.920	0.160	125	0.0110	0.0119	W13	
N3012ZD200	2000	3012	45100	10.2 x 10 ⁶	0.920	0.160	125	0.0110	0.0119	W46	
N3012ZD260	2600	3012	45100	10.2 x 10 ⁶	0.920	0.160	125	0.0110	0.0119	W46	
N3022MK080	800	3022	38200	7.30 x 10 ⁶	0.981	0.090	125	0.0140	0.0157	WP3	W82 Weight 1650 g
N3022MK120	1200	3022	38200	7.30 x 10 ⁶	0.981	0.090	125	0.0140	0.0157	WP3	
N3022MK140	1400	3022	38200	7.30 x 10 ⁶	0.981	0.090	125	0.0140	0.0157	WP3	
N3029ZC240	2400	3029	38200	7.30 x 10 ⁶	0.947	0.154	125	0.0110	0.0119	W13	
N3029ZC280	2800	3029	38200	7.30 x 10 ⁶	0.947	0.154	125	0.0110	0.0119	W13	
N3029ZD240	2400	3029	38200	7.30 x 10 ⁶	0.947	0.154	125	0.0110	0.0119	W46	
N3029ZD280	2800	3029	38200	7.30 x 10 ⁶	0.947	0.154	125	0.0110	0.0119	W46	
➤ N3165HA260	2600	3165	36000	6.48 x 10 ⁶	0.930	0.150	125	0.0105	0.0118	W79	
➤ N3165HA280	2800	3165	36000	6.48 x 10 ⁶	0.930	0.150	125	0.0105	0.0118	W79	
➤ N3175HE160	1600	3175	45500	10.40 x 10 ⁶	0.900	0.110	125	0.0125	0.0138	W80	W90 Weight 90 g
➤ N3175HE180	1800	3175	45500	10.40 x 10 ⁶	0.900	0.110	125	0.0125	0.0138	W80	
N3229QK020	200	3229	28000	3.92 x 10 ⁶	0.926	0.067	140	0.0180	0.0217	WP2	
N3229QK040	400	3229	28000	3.92 x 10 ⁶	0.926	0.067	140	0.0180	0.0217	WP2	
N3229QK060	600	3229	28000	3.92 x 10 ⁶	0.926	0.067	140	0.0180	0.0217	WP2	
N3533ZC180	1800	3533	50000	12.50 x 10 ⁶	0.970	0.095	125	0.0110	0.0120	W13	
N3533ZC220	2200	3533	50000	12.50 x 10 ⁶	0.970	0.095	125	0.0110	0.0120	W13	
N3533ZD180	1800	3533	50000	12.50 x 10 ⁶	0.970	0.095	125	0.0110	0.0120	W46	
N3533ZD220	2200	3533	50000	12.50 x 10 ⁶	0.970	0.095	125	0.0110	0.0120	W46	
➤ N3565HA160	1600	3565	45500	10.4 x 10 ⁶	0.900	0.110	125	0.0105	0.0118	W79	W91 Weight 110 g
➤ N3565HA180	1800	3565	45500	10.4 x 10 ⁶	0.900	0.110	125	0.0105	0.0118	W79	
N3597ML020	200	3597	45400	10.3 x 10 ⁶	0.840	0.053	140	0.0180	0.0201	WP5	
N3597ML040	400	3597	45400	10.3 x 10 ⁶	0.840	0.053	140	0.0180	0.0201	WP5	
N3597ML060	600	3597	45400	10.3 x 10 ⁶	0.840	0.053	140	0.0180	0.0201	WP5	
N3790TE240	2400	3790	49500	12.3 x 10 ⁶	0.900	0.150	125	0.0080	0.0084	W82	W92 Weight 280 g
N3790TE280	2800	3790	49500	12.3 x 10 ⁶	0.900	0.150	125	0.0080	0.0084	W82	
N3790TJ240	2400	3790	49500	12.3 x 10 ⁶	0.900	0.150	125	0.0080	0.0084	W81	
N3790TJ280	2800	3790	49500	12.3 x 10 ⁶	0.900	0.150	125	0.0080	0.0084	W81	

Phase Control Thyristors

Capsule Types

Part No.	V_{DRM}	I_{TAV}	I_{TSM}	I^2t	V_{TO}	r_T	T_{JM}	R_{thJK}		Fig. No.	Package style
	V_{RRM}	$T_K = 55^\circ C$	10 ms ½ sine $V_R \leq 60\% V_{RRM}$		@ T_{JM}			180° Sine	120° Rect.		
➤ New	V	A	A	A ² s	V	mΩ	°C	K/W	K/W		Outlines on pages O-01...O-30
N3839TC300 *	3000	3839	49500	12.25 x 10 ⁶	0.950	0.140	125	0.0080	0.0089	W14	
N3839TC350 *	3500	3839	49500	12.25 x 10 ⁶	0.950	0.140	125	0.0080	0.0089	W14	
N3839TD300 *	3000	3839	49500	12.25 x 10 ⁶	0.950	0.140	125	0.0080	0.0089	W51	
N3839TD350 *	3500	3839	49500	12.25 x 10 ⁶	0.950	0.140	125	0.0080	0.0089	W51	
N3880ZD160	1600	3880	59000	17.4 x 10 ⁶	0.986	0.068	125	0.0110	0.0119	W46	
N3880ZD180	1800	3880	59000	17.4 x 10 ⁶	0.986	0.068	125	0.0110	0.0119	W46	
N3904HK200	2000	3904	50900	12.95 x 10 ⁶	0.920	0.111	125	0.0090	0.0099	WP4	WP1 Weight 180 g
N3904HK220	2200	3904	50900	12.95 x 10 ⁶	0.920	0.111	125	0.0090	0.0099	WP4	
N3930ZC120	1200	3930	54000	14.6 x 10 ⁶	0.841	0.080	125	0.0110	0.0119	W13	
N3930ZC160	1600	3930	54000	14.6 x 10 ⁶	0.841	0.080	125	0.0110	0.0119	W13	
N3930ZD120	1200	3930	54000	14.6 x 10 ⁶	0.841	0.080	125	0.0110	0.0119	W46	
N3930ZD160	1600	3930	54000	14.6 x 10 ⁶	0.841	0.080	125	0.0110	0.0119	W46	
N4085ZC080	800	4085	64000	20.5 x 10 ⁶	0.850	0.070	125	0.0110	0.0119	W13	WP2 Weight 200 g
N4085ZC120	1200	4085	64000	20.5 x 10 ⁶	0.850	0.070	125	0.0110	0.0119	W13	
N4085ZD080	800	4085	64000	20.5 x 10 ⁶	0.850	0.070	125	0.0110	0.0119	W46	
N4085ZD120	1200	4085	64000	20.5 x 10 ⁶	0.850	0.070	125	0.0110	0.0119	W46	
N4151FC360	3600	4151	54000	14.6 x 10 ⁶	0.850	0.170	125	0.0065	0.0069	W15	
N4151FC420	4200	4151	54000	14.6 x 10 ⁶	0.850	0.170	125	0.0065	0.0069	W15	
N4151FD360	3600	4151	54000	14.6 x 10 ⁶	0.850	0.170	125	0.0065	0.0069	W48	
N4151FD420	4200	4151	54000	14.6 x 10 ⁶	0.850	0.170	125	0.0065	0.0069	W48	
N4316MK020	200	4316	45400	10.3 x 10 ⁶	0.840	0.053	140	0.0140	0.0157	WP3	WP3 Weight 260 g
N4316MK040	400	4316	45400	10.3 x 10 ⁶	0.840	0.053	140	0.0140	0.0157	WP3	
N4316MK060	600	4316	45400	10.3 x 10 ⁶	0.840	0.053	140	0.0140	0.0157	WP3	
➤ N4340TE180	1800	4340	55000	15.1 x 10 ⁶	0.886	0.105	125	0.0080	0.0085	W82	
➤ N4340TE220	2200	4340	55000	15.1 x 10 ⁶	0.886	0.105	125	0.0080	0.0085	W82	
➤ N4340TJ180	1800	4340	55000	15.1 x 10 ⁶	0.886	0.105	125	0.0080	0.0085	W81	
➤ N4340TJ220	2200	4340	55000	15.1 x 10 ⁶	0.886	0.105	125	0.0080	0.0085	W81	
N4472HK160	1600	4472	59000	17.40 x 10 ⁶	0.986	0.068	125	0.0090	0.0099	WP4	WP4 Weight 550 g
N4472HK180	1800	4472	59000	17.40 x 10 ⁶	0.986	0.068	125	0.0090	0.0099	WP4	
N4803FC300	3000	4803	60000	18.0 x 10 ⁶	0.920	0.110	125	0.0065	0.0069	W15	
N4803FC350	3500	4803	60000	18.0 x 10 ⁶	0.920	0.110	125	0.0065	0.0069	W15	
N4803FD300	3000	4803	60000	18.0 x 10 ⁶	0.920	0.110	125	0.0065	0.0069	W48	
N4803FD350	3500	4803	60000	18.0 x 10 ⁶	0.920	0.110	125	0.0065	0.0069	W48	
N5177FC200	2000	5177	67500	22.8 x 10 ⁶	0.800	0.100	125	0.0065	0.0069	W15	WP5 Weight 500 g
N5177FC280	2800	5177	67500	22.8 x 10 ⁶	0.800	0.100	125	0.0065	0.0069	W15	
N5177FD200	2000	5177	67500	22.8 x 10 ⁶	0.800	0.100	125	0.0065	0.0069	W48	
N5177FD280	2800	5177	67500	22.8 x 10 ⁶	0.800	0.100	125	0.0065	0.0069	W48	
N5946FC180	1800	5946	72000	25.9 x 10 ⁶	0.855	0.065	125	0.0065	0.0069	W15	
N5946FC220	2200	5946	72000	25.9 x 10 ⁶	0.855	0.065	125	0.0065	0.0069	W15	
N5946FD180	1800	5946	72000	25.9 x 10 ⁶	0.855	0.065	125	0.0065	0.0069	W48	
N5946FD220	2200	5946	72000	25.9 x 10 ⁶	0.855	0.065	125	0.0065	0.0069	W48	
N6012ZD020	200	6012	65000	21.13 x 10 ⁶	0.853	0.029	140	0.0110	0.0119	W46	WP6 Weight 330 g
N6012ZD040	400	6012	65000	21.13 x 10 ⁶	0.853	0.029	140	0.0110	0.0119	W46	
N6012ZD060	600	6012	65000	21.13 x 10 ⁶	0.853	0.029	140	0.0110	0.0119	W46	
N6974HK020	200	6974	65000	21.13 x 10 ⁶	0.853	0.029	140	0.0090	0.0099	WP4	WP4
N6974HK040	400	6974	65000	21.13 x 10 ⁶	0.853	0.029	140	0.0090	0.0099	WP4	
N6974HK060	600	6974	65000	21.13 x 10 ⁶	0.853	0.029	140	0.0090	0.0099	WP4	

* = Please consult factory for new products to be introduced 2015

Medium Voltage Thyristors

Medium voltage applications place additional demands on phase controlled thyristors. To meet these demands we have developed a comprehensive range of thyristors optimised for medium voltage applications and series operation. As voltages increase, so do switching losses and turn-off time to a point where they become significant in line frequency applications. Our patented distributed gate architecture ensures excellent switching performance over a wide range of voltage, current and di/dt. Device lifetime is also engineered to achieve an optimum balance between conduction losses, commutation losses and turn-off time to give maximum power handling from line frequency to 400Hz. This also gives significant benefits when series or parallel connection of devices is required. Medium voltage thyristors are available from 3.2kV up to 6.5kV with silicon diameters from 38mm to 100mm making them particularly suitable for high power converters such as medium voltage DC drives, medium voltage soft starts and utility applications such as HVDC, static VAR compensators, excitation and transfer switches.

We recognise the importance of reliability in these large, capital intensive applications and as a result we subject these parts to extended levels of both routine and type testing to ensure that your investment gives years of trouble free service.

Capsule Types



Part No.	V _{DRM} V _{RRM}	I _{TAV} T _K = 55°C	I _{TSM}	I ² t 10 ms ½ sine V _R - ≤ 60% V _{RRM}	t _q @ 200 V/μs	Typ. Reverse Recovery Charge			V _{TO}	r _T @ T _{JM}	T _{JM}	R _{thJK}		Fig. No.
						Q _{rr}	@ I _{TM}	@ -di/dt				180° Sine	120° Rect.	
○ Not for new design ➤ New	V	A	A	A ² s	μs	μC	A	A/μs	V	mΩ	°C	K/W	K/W	
➤ K0445LG600	6000	445	5200	135 × 10 ³	700-1000	3100	500	10	1.620	2.260	125	0.0380	0.0429	W56
➤ K0445LG650	6500	445	5200	135 × 10 ³	700-1000	3100	500	10	1.620	2.260	125	0.0380	0.0429	W56
➤ K0500LC600	6000	500	5200	135 × 10 ³	700-1000	3100	500	10	1.620	2.260	125	0.0320	0.0361	W10
➤ K0500LC650	6500	500	5200	135 × 10 ³	700-1000	3100	500	10	1.620	2.260	125	0.0320	0.0361	W10
➤ K0560QE600	6000	560	7100	252 × 10 ³	750-1050	4400	700	10	1.670	1.720	125	0.0310	0.0350	W76
➤ K0560QE650	6500	560	7100	252 × 10 ³	750-1050	4400	700	10	1.670	1.720	125	0.0310	0.0350	W76
➤ K0625QA600	6000	625	7100	252 × 10 ³	750-1050	4400	700	10	1.670	1.720	125	0.0260	0.0294	W75
➤ K0625QA650	6500	625	7100	252 × 10 ³	750-1050	4400	700	10	1.670	1.720	125	0.0260	0.0294	W75
K0890NC360	3600	890	10900	594 × 10 ³	350-550	4000	1000	10	1.516	0.800	125	0.0240	0.0270	W11
K0890NC420	4200	890	10900	594 × 10 ³	350-550	4000	1000	10	1.516	0.800	125	0.0240	0.0270	W11
➤ K0900ME600	6000	900	10200	520 × 10 ³	850-1150	6200	1000	10	1.660	1.190	125	0.0180	0.0203	W78
➤ K0900ME650	6500	900	10200	520 × 10 ³	850-1150	6200	1000	10	1.660	1.190	125	0.0180	0.0203	W78
○ K1000MA600	6000	1000	12500	781 × 10 ³	700-1000	6500	2000	10	1.390	0.860	125	0.0200	0.0220	W77
○ K1000MA650	6500	1000	12500	781 × 10 ³	700-1000	6500	2000	10	1.390	0.860	125	0.0200	0.0220	W77
○ K1000ME600	6000	1000	12500	781 × 10 ³	700-1000	6500	2000	10	1.390	0.860	125	0.0200	0.0220	W78
○ K1000ME650	6500	1000	12500	781 × 10 ³	700-1000	6500	2000	10	1.390	0.860	125	0.0200	0.0220	W78
➤ K1010MA600	6000	1010	10200	520 × 10 ³	850-1150	6200	1000	10	1.660	1.190	125	0.0150	0.0170	W77
➤ K1010MA650	6500	1010	10200	520 × 10 ³	850-1150	6200	1000	10	1.660	1.190	125	0.0150	0.0170	W77
K1120NC360	3600	1120	13500	911 × 10 ³	650-1000	5000	1000	10	1.092	0.546	125	0.0240	0.0271	W11
K1120NC420	4200	1120	13500	911 × 10 ³	650-1000	5000	1000	10	1.092	0.546	125	0.0240	0.0271	W11
K1120NG360	3600	1120	13500	911 × 10 ³	650-1000	5000	1000	10	1.092	0.546	125	0.0240	0.0271	W57
K1120NG420	4200	1120	13500	911 × 10 ³	650-1000	5000	1000	10	1.092	0.546	125	0.0240	0.0271	W57
K1121NC320	3200	1121	15000	1.13 × 10 ⁶	200-300	2000	1000	10	1.098	0.542	125	0.0240	0.0270	W11
K1121NC360	3600	1121	15000	1.13 × 10 ⁶	200-300	2000	1000	10	1.098	0.542	125	0.0240	0.0270	W11
K1197NC300	3000	1197	10650	567 × 10 ³	200-300	2700	1000	10	1.335	0.372	125	0.0240	0.0270	W11
K1197NC320	3200	1197	10650	567 × 10 ³	200-300	2700	1000	10	1.335	0.372	125	0.0240	0.0270	W11
➤ K1495HE600	6000	1495	21800	2.37 × 10 ⁶	1200-1500	8800	2000	10	1.630	0.570	125	0.0125	0.0138	W80
➤ K1495HE650	6500	1495	21800	2.37 × 10 ⁶	1200-1500	8800	2000	10	1.630	0.570	125	0.0125	0.0138	W80
➤ K1670HA600	6000	1670	21800	2.37 × 10 ⁶	1200-1500	8800	2000	10	1.630	0.570	125	0.0105	0.0118	W79
➤ K1670HA650	6500	1670	21800	2.37 × 10 ⁶	1200-1500	8800	2000	10	1.630	0.570	125	0.0105	0.0118	W79

Outlines on pages O-01...O-30



W11 Weight 510 g



W12 Weight 1000 g



W13 Weight 1700 g



W14 Weight 1300 g

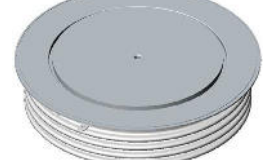

W15 Weight 2800 g

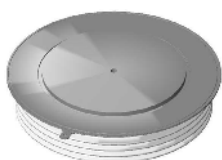

W46 Weight 1200 g

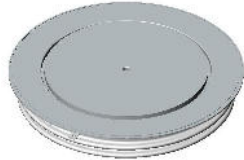

W48 Weight 2000 g

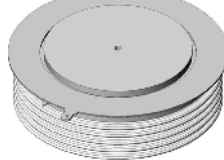

W51 Weight 1700 g

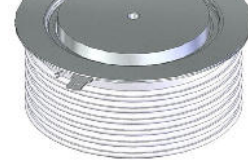

W57 Weight 326 g

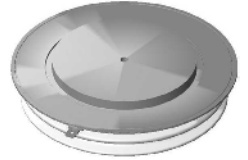

W62 Weight 1000 g

Medium Voltage Thyristors

Capsule Types

Part No.	V_{DRM}	I_{TAV}	I_{TSM}	I^2t	t_q @ 200 V/ μ s	Typ. Reverse Recovery Charge			V_{TO}	r_T	T_{JM}	R_{thJK}		Fig. No.
	V_{RRM}	$T_K = 55^\circ C$	10 ms $\frac{1}{2}$ sine $V_R \leq 60\% V_{RRM}$	A^2s		Q_{rr}	T_{JM} @ I_{TM}	@ $-di/dt$				@ T_{JM}	180° Sine	
➤ New	V	A	A	A ² s	μ s	μ C	A	A/ μ s	V	m Ω	°C			
K1947ZC400	4000	1947	25000	3.13×10^6	600-700	8800	1000	10	1.221	0.425	125	0.0110	0.0119	W13
K1947ZC450	4500	1947	25000	3.13×10^6	600-700	8800	1000	10	1.221	0.425	125	0.0110	0.0119	W13
K1947ZD400	4000	1947	25000	3.13×10^6	600-700	8800	1000	10	1.221	0.425	125	0.0110	0.0119	W46
K1947ZD450	4500	1947	25000	3.13×10^6	600-700	8800	1000	10	1.221	0.425	125	0.0110	0.0119	W46
K2065VC360 *	3600	2065	28000	3.92×10^6	400-700	6700	2000	10	1.121	0.291	125	0.0130	0.0145	W12
K2065VC420 *	4200	2065	28000	3.92×10^6	400-700	6700	2000	10	1.121	0.291	125	0.0130	0.0145	W12
K2065VF360 *	3600	2065	28000	3.92×10^6	400-700	6700	2000	10	1.121	0.291	125	0.0130	0.0145	W62
K2065VF420 *	4200	2065	28000	3.92×10^6	400-700	6700	2000	10	1.121	0.291	125	0.0130	0.0145	W62
➤ K2085TE600	6000	2085	33000	5.44×10^6	1400-1750	12400	3000	10	1.580	0.380	125	0.0095	0.0107	W82
➤ K2085TE650	6500	2085	33000	5.44×10^6	1400-1750	12400	3000	10	1.580	0.380	125	0.0095	0.0107	W82
K2095ZC360	3600	2095	18200	1.66×10^6	400-500	4550	2000	10	1.502	0.296	125	0.0110	0.0119	W13
K2095ZC420	4200	2095	18200	1.66×10^6	400-500	4550	2000	10	1.502	0.296	125	0.0110	0.0119	W13
K2095ZD360	3600	2095	18200	1.66×10^6	400-500	4550	2000	10	1.502	0.296	125	0.0110	0.0119	W46
K2095ZD420	4200	2095	18200	1.66×10^6	400-500	4550	2000	10	1.502	0.296	125	0.0110	0.0119	W46
➤ K2325TJ600	6000	2325	33000	5.44×10^6	1400-1750	12400	3000	10	1.580	0.380	125	0.0080	0.0085	W81
➤ K2325TJ650	6500	2325	33000	5.44×10^6	1400-1750	12400	3000	10	1.580	0.380	125	0.0080	0.0085	W81
K2359TC600 *	6000	2359	27000	3.65×10^6	1100-1500	11500	2000	10	1.391	0.360	115	0.0085	0.0092	W14
K2359TC650 *	6500	2359	27000	3.65×10^6	1100-1500	11500	2000	10	1.391	0.360	115	0.0085	0.0092	W14
K2359TD600 *	6000	2359	27000	3.65×10^6	1100-1500	11500	2000	10	1.391	0.360	115	0.0085	0.0092	W51
K2359TD650 *	6500	2359	27000	3.65×10^6	1100-1500	11500	2000	10	1.391	0.360	115	0.0085	0.0092	W51
K2960TC450 *	4500	2960	32500	5.28×10^6	800-1600	17000	4000	10	1.229	0.212	125	0.0085	0.0092	W14
K2960TC480 *	4800	2960	32500	5.28×10^6	800-1600	17000	4000	10	1.229	0.212	125	0.0085	0.0092	W14
K2960TC520 *	5200	2960	32500	5.28×10^6	800-1600	17000	4000	10	1.229	0.212	125	0.0085	0.0092	W14
K2960TD450 *	4500	2960	32500	5.28×10^6	800-1600	17000	4000	10	1.229	0.212	125	0.0085	0.0092	W51
K2960TD480 *	4800	2960	32500	5.28×10^6	800-1600	17000	4000	10	1.229	0.212	125	0.0085	0.0092	W51
K2960TD520 *	5200	2960	32500	5.28×10^6	800-1600	17000	4000	10	1.229	0.212	125	0.0085	0.0092	W51
K2973FC600 *	6000	2973	35400	6.27×10^6	1100-1500	15000	4000	10	1.581	0.207	115	0.0065	0.0069	W15
K2973FC650 *	6500	2973	35400	6.27×10^6	1100-1500	15000	4000	10	1.581	0.207	115	0.0065	0.0069	W15
K2973FD600 *	6000	2973	35400	6.27×10^6	1100-1500	15000	4000	10	1.581	0.207	115	0.0065	0.0069	W48
K2973FD650 *	6500	2973	35400	6.27×10^6	1100-1500	15000	4000	10	1.581	0.207	115	0.0065	0.0069	W48
K3362TC360 *	3600	3362	39500	7.80×10^6	1000-2000	12000	4000	10	1.052	0.168	125	0.0085	0.0092	W14
K3362TC420 *	4200	3362	39500	7.80×10^6	1000-2000	12000	4000	10	1.052	0.168	125	0.0085	0.0092	W14
K3362TD360 *	3600	3362	39500	7.80×10^6	1000-2000	12000	4000	10	1.052	0.168	125	0.0085	0.0092	W51
K3362TD420 *	4200	3362	39500	7.80×10^6	1000-2000	12000	4000	10	1.052	0.168	125	0.0085	0.0092	W51
K3503FC450 *	4500	3503	43200	9.33×10^6	900-1800	8000	4000	10	1.375	0.196	125	0.0065	0.0070	W15
K3503FC480 *	4800	3503	43200	9.33×10^6	900-1800	8000	4000	10	1.375	0.196	125	0.0065	0.0070	W15
K3503FC520 *	5200	3503	43200	9.33×10^6	900-1800	8000	4000	10	1.375	0.196	125	0.0065	0.0070	W15
K3503FD450 *	4500	3503	43200	9.33×10^6	900-1800	8000	4000	10	1.375	0.196	125	0.0065	0.0070	W48
K3503FD480 *	4800	3503	43200	9.33×10^6	900-1800	8000	4000	10	1.375	0.196	125	0.0065	0.0070	W48
K3503FD520 *	5200	3503	43200	9.33×10^6	900-1800	8000	4000	10	1.375	0.196	125	0.0065	0.0070	W48

* New parts in development, please consult factory for more details

Outlines on pages O-01...O-30



W75 Weight 330 g



W76 Weight 420 g

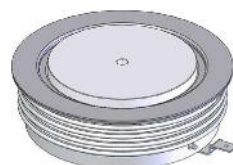

W77 Weight 550 g

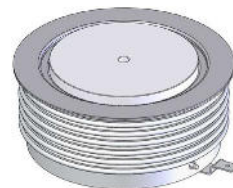

W78 Weight 730 g



W79 Weight 890 g



W80 Weight 1200 g

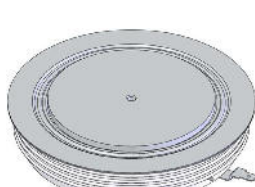

W81 Weight 1200 g

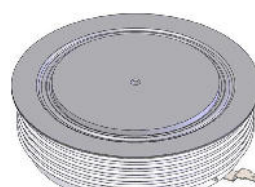

W82 Weight 1650 g

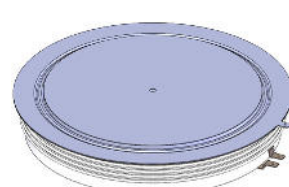

W103 Weight 3200 g

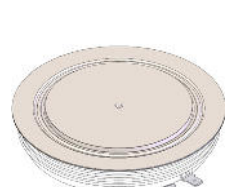



W104 Weight 1500 g

Fast Turn Off Thyristors

IXYS UK Westcode Ltd's "P" series of fast switching thyristors have regenerative gate structure to ensure low switching losses and high di/dt performance. "P" Series devices are suitable for existing inverter, DC chopper drives, UPS and Pulse Power applications. In addition to pressure contact technology these devices offer lower reverse recovery charge values, low forward switching losses and high reliability. These devices are not recommended for new designs.



Stud Types

Part No.	V_{DRM}	I_{TAV}	I_{TSM}	I^2t	t_q	Typ. Reverse Recovery Charge			V_{T0}	r_T	R_{thJC}	Fig. No.	Package style Outlines on pages O-01...O-30
	V_{RRM}	$T_C = 55^\circ C$	10 ms $\frac{1}{2}$ sine	$V_R - \leq 60\% V_{RRM}$	@ 200 V/ μs	T_{JM}			@ T_{JM}		180° sine		
	V	A	A	A ² s	μs	Q_{rr}	@ I_{TM}	@ -di/dt	V	m Ω	K/W		
P0128SH10C	1000	128	1700	19×10^3	15	50	100	10	1.600	2.490	0.2300	W17	
P0128SH10D	1000	128	1700	19×10^3	20	50	100	10	1.600	2.490	0.2300	W17	
P0128SH10E	1000	128	1700	19×10^3	25	50	100	10	1.600	2.490	0.2300	W17	
P0128SH12C	1200	128	1700	19×10^3	15	50	100	10	1.600	2.490	0.2300	W17	
P0128SH12D	1200	128	1700	19×10^3	20	50	100	10	1.600	2.490	0.2300	W17	
P0128SH12E	1200	128	1700	19×10^3	25	50	100	10	1.600	2.490	0.2300	W17	
P0128SJ10C	1000	128	1700	19×10^3	15	50	100	10	1.600	2.490	0.2300	W16	
P0128SJ10D	1000	128	1700	19×10^3	20	50	100	10	1.600	2.490	0.2300	W16	
P0128SJ10E	1000	128	1700	19×10^3	25	50	100	10	1.600	2.490	0.2300	W16	
P0128SJ12C	1200	128	1700	19×10^3	15	50	100	10	1.600	2.490	0.2300	W16	
P0128SJ12D	1200	128	1700	19×10^3	20	50	100	10	1.600	2.490	0.2300	W16	
P0128SJ12E	1200	128	1700	19×10^3	25	50	100	10	1.600	2.490	0.2300	W16	
P0248SC12D	1200	248	2700	36.5×10^3	20	45	300	20	1.600	1.230	0.1200	W18	
P0248SC12E	1200	248	2700	36.5×10^3	25	45	300	20	1.600	1.230	0.1200	W18	
P0273SC12D	1200	273	3250	52.8×10^3	20	80	300	20	1.550	0.870	0.1200	W18	
P0273SC12E	1200	273	3250	52.8×10^3	25	80	300	20	1.550	0.870	0.1200	W18	
P0273SC12F	1200	273	3250	52.8×10^3	30	80	300	20	1.550	0.870	0.1200	W18	
P0306SC08A	800	306	4700	110×10^3	10	50	300	20	1.400	0.670	0.1200	W18	
P0306SC08B	800	306	4700	110×10^3	12	50	300	20	1.400	0.670	0.1200	W18	
P0306SC08C	800	306	4700	110×10^3	15	50	300	20	1.400	0.670	0.1200	W18	
P0311SC12E	1200	311	3600	64.8×10^3	25	55	300	20	1.170	0.920	0.1200	W18	
P0311SC12F	1200	311	3600	64.8×10^3	30	55	300	20	1.170	0.920	0.1200	W18	
P0330SC04A	400	330	5000	125×10^3	10	55	300	20	1.050	0.880	0.1200	W18	
P0330SC04C	400	330	5000	125×10^3	15	55	300	20	1.050	0.880	0.1200	W18	
P0330SC06A	600	330	5000	125×10^3	10	55	300	20	1.050	0.880	0.1200	W18	
P0330SC06C	600	330	5000	125×10^3	15	55	300	20	1.050	0.880	0.1200	W18	
P0330SC08A	800	330	5000	125×10^3	10	55	300	20	1.050	0.880	0.1200	W18	
P0330SC08C	800	330	5000	125×10^3	15	55	300	20	1.050	0.880	0.1200	W18	
P0431SC04B	400	431	6500	211×10^3	12	190	300	20	0.950	0.377	0.1200	W18	
P0431SC04C	400	431	6500	211×10^3	15	190	300	20	0.950	0.377	0.1200	W18	
P0431SC06B	600	431	6500	211×10^3	12	190	300	20	0.950	0.377	0.1200	W18	
P0431SC06C	600	431	6500	211×10^3	15	190	300	20	0.950	0.377	0.1200	W18	

$T_{JM} = 125^\circ C$

Fast Turn Off Thyristors

Capsule Types

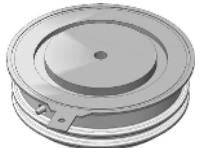













Part No.	V_{DRM}	I_{TAV}	I_{TSM}	I^2t	t_q	Typ. Reverse Recovery Charge			V_{TO}	r_T	R_{thJC}	Fig. No.	Package style Outlines on pages O-01...O-30
	V_{RRM}	$T_K = 55^\circ C$	10 ms	1/2 sine	@ 200 V/ μs	T_{JM}			@ T_{JM}		d.c. 180° sine		
	V	A	A	A ² s	μs	Q_{rr}	@ I_{TM}	@ -di/dt	V	m Ω	K/W		
P0295WC12D	1200	295	2700	36.5 x 10 ³	20	50	300	20	1.600	1.230	0.0950	W8	
P0295WC12E	1200	295	2700	36.5 x 10 ³	25	50	300	20	1.600	1.230	0.0950	W8	
P0327WC08C	800	327	3250	63.9 x 10 ³	15	45	300	20	1.550	0.870	0.0950	W8	 W8 Weight 70 g
P0327WC08D	800	327	3250	63.9 x 10 ³	20	45	300	20	1.550	0.870	0.0950	W8	
P0327WC08E	800	327	3250	63.9 x 10 ³	25	45	300	20	1.550	0.870	0.0950	W8	
P0327WC08F	800	327	3250	63.9 x 10 ³	30	45	300	20	1.550	0.870	0.0950	W8	
P0327WC12C	1200	327	3250	63.9 x 10 ³	15	45	300	20	1.550	0.870	0.0950	W8	
P0327WC12D	1200	327	3250	63.9 x 10 ³	20	45	300	20	1.550	0.870	0.0950	W8	
P0327WC12E	1200	327	3250	63.9 x 10 ³	25	45	300	20	1.550	0.870	0.0950	W8	
P0327WC12F	1200	327	3250	63.9 x 10 ³	30	45	300	20	1.550	0.870	0.0950	W8	
P0366WC04A	400	366	4700	110 x 10 ³	10	25	300	20	1.400	0.670	0.0950	W8	 W10 Weight 340 g
P0366WC04B	400	366	4700	110 x 10 ³	12	25	300	20	1.400	0.670	0.0950	W8	
P0366WC04C	400	366	4700	110 x 10 ³	15	25	300	20	1.400	0.670	0.0950	W8	
P0366WC06A	600	366	4700	110 x 10 ³	10	25	300	20	1.400	0.670	0.0950	W8	
P0366WC06B	600	366	4700	110 x 10 ³	12	25	300	20	1.400	0.670	0.0950	W8	
P0366WC06C	600	366	4700	110 x 10 ³	15	25	300	20	1.400	0.670	0.0950	W8	
P0366WC08A	800	366	4700	110 x 10 ³	10	25	300	20	1.400	0.670	0.0950	W8	
P0366WC08B	800	366	4700	110 x 10 ³	12	25	300	20	1.400	0.670	0.0950	W8	
P0366WC08C	800	366	4700	110 x 10 ³	15	25	300	20	1.400	0.670	0.0950	W8	
P0367WC12E	1200	367	3600	64.8 x 10 ³	25	50	300	20	1.170	0.920	0.0950	W8	
P0367WC12F	1200	367	3600	64.8 x 10 ³	30	50	300	20	1.170	0.920	0.0950	W8	
P0389WC04B	400	389	5000	125 x 10 ³	12	30	300	20	1.050	0.880	0.0950	W8	
P0389WC04C	400	389	5000	125 x 10 ³	15	30	300	20	1.050	0.880	0.0950	W8	
P0389WC08B	800	389	5000	125 x 10 ³	12	30	300	20	1.050	0.880	0.0950	W8	
P0389WC08C	800	389	5000	125 x 10 ³	15	30	300	20	1.050	0.880	0.0950	W8	
P0515WC04B	400	515	6500	211 x 10 ³	12	180	300	20	0.950	0.377	0.0950	W8	 W58 Weight 90 g
P0515WC04C	400	515	6500	211 x 10 ³	15	180	300	20	0.950	0.377	0.0950	W8	
P0515WC04D	400	515	6500	211 x 10 ³	20	180	300	20	0.950	0.377	0.0950	W8	
P0515WC06B	600	515	6500	211 x 10 ³	12	180	300	20	0.950	0.377	0.0950	W8	
P0515WC06C	600	515	6500	211 x 10 ³	15	180	300	20	0.950	0.377	0.0950	W8	
P0515WC06D	600	515	6500	211 x 10 ³	20	180	300	20	0.950	0.377	0.0950	W8	
P0838LC06B	600	1110	12300	750 x 10 ³	12	160	800	50	1.200	0.280	0.0320	W10	
P0838LC06C	600	1110	12300	750 x 10 ³	15	160	800	50	1.200	0.280	0.0320	W10	
P0848YC04B	400	848	8750	383 x 10 ³	12	200	550	40	1.010	0.305	0.0500	W58	
P0848YC04C	400	848	8750	383 x 10 ³	15	200	550	40	1.010	0.305	0.0500	W58	
P0848YC06B	600	848	8750	383 x 10 ³	12	200	550	40	1.010	0.305	0.0500	W58	
P0848YC06C	600	848	8750	383 x 10 ³	15	200	550	40	1.010	0.305	0.0500	W58	
P1007LC08D	800	1007	9500	451 x 10 ³	20	400	800	50	1.509	0.265	0.0320	W10	
P1007LC08E	800	1007	9500	451 x 10 ³	25	400	800	50	1.509	0.265	0.0320	W10	
P1007LC08F	800	1007	9500	451 x 10 ³	30	400	800	50	1.509	0.265	0.0320	W10	
P1007LC12D	1200	1007	9500	451 x 10 ³	20	400	800	50	1.509	0.265	0.0320	W10	
P1007LC12E	1200	1007	9500	451 x 10 ³	25	400	800	50	1.509	0.265	0.0320	W10	
P1007LC12F	1200	1007	9500	451 x 10 ³	30	400	800	50	1.509	0.265	0.0320	W10	

$T_{JM} = 125^\circ C$

Distributed Gate Thyristors

IXYS UK Westcode Ltd is recognised as the Worldwide leader in distributed gate technology. These devices are available with blocking voltages to 4.5kV and average current to 4kA, with t_q from 10 to 300 μ s. The unique distributed gate design and lifetime control features give these devices both high di/dt capability and fast, low recovery turn-off, while maintaining a low on-state voltage drop. Ideally suited to applications including: induction power supplies, high frequency inverters/converters, UPS and pulse power.



Capsule Types

Part No.	V_{DRM}	V_{RRM}	I_{TAV}	I_{TSM}	I^2t	t_q	Typ. Reverse Recovery Charge			V_{TO}	r_T	R_{thJK}	Fig. No.	Package style
							Q_{rr}	@ T_{JM} @ I_{TM}	@ -di/dt					
➤ New	V	V	A	A	10 ms ½ sine $V_R \leq 60\% V_{RRM}$ A ² s	@ 200 V/ μ s μ s	μ C	A	A/ μ s	V	m Ω	180° Sine K/W		Outlines on pages O-01...O-30
R0472YC12E	1200	1200	472	4300	92.5 x 10 ³	25	155	550	40	1.648	1.125	0.050	W58	
R0472YC12F	1200	1200	472	4300	92.5 x 10 ³	30	155	550	40	1.648	1.125	0.050	W58	
R0472YC16E	1600	1600	472	4300	92.5 x 10 ³	25	155	550	40	1.648	1.125	0.050	W58	
R0472YC16F	1600	1600	472	4300	92.5 x 10 ³	30	155	550	40	1.648	1.125	0.050	W58	
R0487YC12D	1200	1200	487	4300	92.5 x 10 ³	20	90	550	40	1.738	0.943	0.0500	W58	
R0487YC12E	1200	1200	487	4300	92.5 x 10 ³	25	90	550	40	1.738	0.943	0.0500	W58	
R0487YC14D	1400	1400	487	4300	92.5 x 10 ³	20	90	550	40	1.738	0.943	0.0500	W58	
R0487YC14E	1400	1400	487	4300	92.5 x 10 ³	25	90	550	40	1.738	0.943	0.0500	W58	
R0577YC12C	1200	1200	577	6000	180 x 10 ³	15	150	550	40	1.510	0.640	0.0500	W58	
R0577YC12D	1200	1200	577	6000	180 x 10 ³	20	150	550	40	1.510	0.640	0.0500	W58	
R0577YC12E	1200	1200	577	6000	180 x 10 ³	25	150	550	40	1.510	0.640	0.0500	W58	
R0633YC12D	1200	1200	633	6300	200 x 10 ³	20	125	550	40	1.250	0.614	0.0500	W58	
R0633YC12E	1200	1200	633	6300	200 x 10 ³	25	125	550	40	1.250	0.614	0.0500	W58	
R0633YC12F	1200	1200	633	6300	200 x 10 ³	30	125	550	40	1.250	0.614	0.0500	W58	
R0717LC14G	1400	1400	717	7050	248.5 x 10 ³	35	425	1000	60	1.752	0.732	0.0320	W10	
➤ R0717LC18G	1800	1800	717	7050	248.5 x 10 ³	35	425	1000	60	1.752	0.732	0.0320	W10	
R0736LC20J	2000	2000	736	6800	231 x 10 ³	50	640	1000	60	1.842	0.619	0.0320	W10	
R0736LC20K	2000	2000	736	6800	231 x 10 ³	60	640	1000	60	1.842	0.619	0.0320	W10	
R0736LC22J	2200	2000	736	6800	231 x 10 ³	50	640	1000	60	1.842	0.619	0.0320	W10	
R0736LC22K	2200	2000	736	6800	231 x 10 ³	60	640	1000	60	1.842	0.619	0.0320	W10	
R0736LC25J	2500	2000	736	6800	231 x 10 ³	50	640	1000	60	1.842	0.619	0.0320	W10	
R0736LC25K	2500	2000	736	6800	231 x 10 ³	60	640	1000	60	1.842	0.619	0.0320	W10	
R0736LC25L	2500	2000	736	6800	231 x 10 ³	65	640	1000	60	1.842	0.619	0.0320	W10	
R0736LC25M	2500	2000	736	6800	231 x 10 ³	70	640	1000	60	1.842	0.619	0.0320	W10	
R0809LC10A	1000	1000	809	8000	320 x 10 ³	10	120	1000	60	2.100	0.300	0.0320	W10	
R0809LC10B	1000	1000	809	8000	320 x 10 ³	12	120	1000	60	2.100	0.300	0.0320	W10	
R0830LC12C	1200	1200	830	8500	361 x 10 ³	15	285	1000	60	1.900	0.357	0.0320	W10	
R0830LC12D	1200	1200	830	8500	361 x 10 ³	20	285	1000	60	1.900	0.357	0.0320	W10	
R0830LC12E	1200	1200	830	8500	361 x 10 ³	25	285	1000	60	1.900	0.357	0.0320	W10	
R0830LC12F	1200	1200	830	8500	361 x 10 ³	30	285	1000	60	1.900	0.357	0.0320	W10	
R0830LC14C	1400	1400	830	8500	361 x 10 ³	15	285	1000	60	1.900	0.357	0.0320	W10	
R0830LC14D	1400	1400	830	8500	361 x 10 ³	20	285	1000	60	1.900	0.357	0.0320	W10	
R0830LC14E	1400	1400	830	8500	361 x 10 ³	25	285	1000	60	1.900	0.357	0.0320	W10	
R0830LC14F	1400	1400	830	8500	361 x 10 ³	30	285	1000	60	1.900	0.357	0.0320	W10	
R0878LC18K	1800	1800	878	7500	281 x 10 ³	60	720	1000	60	1.447	0.480	0.0320	W10	
R0878LC18L	1800	1800	878	7500	281 x 10 ³	65	720	1000	60	1.447	0.480	0.0320	W10	
R0878LC18M	1800	1800	878	7500	281 x 10 ³	70	720	1000	60	1.447	0.480	0.0320	W10	
R0878LC20K	2000	1800	878	7500	281 x 10 ³	60	720	1000	60	1.447	0.480	0.0320	W10	
R0878LC20L	2000	1800	878	7500	281 x 10 ³	65	720	1000	60	1.447	0.480	0.0320	W10	
R0878LC20M	2000	1800	878	7500	281 x 10 ³	70	720	1000	60	1.447	0.480	0.0320	W10	
R0878LC21K	2100	1800	878	7500	281 x 10 ³	60	720	1000	60	1.447	0.480	0.0320	W10	
R0878LC21L	2100	1800	878	7500	281 x 10 ³	65	720	1000	60	1.447	0.480	0.0320	W10	
R0878LC21M	2100	1800	878	7500	281 x 10 ³	70	720	1000	60	1.447	0.480	0.0320	W10	
R0929LC10A	1000	1000	929	9000	405 x 10 ³	10	150	1000	60	1.549	0.350	0.0320	W10	
R0929LC10B	1000	1000	929	9000	405 x 10 ³	12	150	1000	60	1.549	0.350	0.0320	W10	
R0929LC10C	1000	1000	929	9000	405 x 10 ³	15	150	1000	60	1.549	0.350	0.0320	W10	
R0929LC12A	1200	1200	929	9000	405 x 10 ³	10	150	1000	60	1.549	0.350	0.0320	W10	
R0929LC12B	1200	1200	929	9000	405 x 10 ³	12	150	1000	60	1.549	0.350	0.0320	W10	
R0929LC12C	1200	1200	929	9000	405 x 10 ³	15	150	1000	60	1.549	0.350	0.0320	W10	
R0929LC12D	1200	1200	929	9000	405 x 10 ³	20	150	1000	60	1.549	0.350	0.0320	W10	
R0929LC12E	1200	1200	929	9000	405 x 10 ³	25	150	1000	60	1.549	0.350	0.0320	W10	
R0964LC10C	1000	1000	964	9400	442 x 10 ³	15	170	1000	60	1.530	0.309	0.0320	W10	
R0964LC10D	1000	1000	964	9400	442 x 10 ³	20	170	1000	60	1.530	0.309	0.0320	W10	
R0964LC10E	1000	1000	964	9400	442 x 10 ³	25	170	1000	60	1.530	0.309	0.0320	W10	











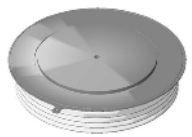

Distributed Gate Thyristors

Capsule Types

Part No.	V _{DRM} V	V _{RRM} V	I _{TAV} A T _K = 55°C	I _{TSM} A	I ² t 10 ms ½ sine V _R - ≤ 60% V _{RRM} A ² s	t _q @ 200 V/μs μs	Typ. Reverse Recovery Charge			V _{TO} V	r _T mΩ	R _{thJK} 180° Sine K/W	Fig. No.	Package style Outlines on pages O-01...O-30
							Q _{rr} μC	@ I _{TM} A	@ -di/dt A/μs					
R0964LC12C	1200	1200	964	9400	442 x 10 ³	15	170	1000	60	1.530	0.309	0.0320	W10	
R0964LC12D	1200	1200	964	9400	442 x 10 ³	20	170	1000	60	1.530	0.309	0.0320	W10	
R0964LC12E	1200	1200	964	9400	442 x 10 ³	25	170	1000	60	1.530	0.309	0.0320	W10	
R0990LC08A	800	800	990	11000	605 x 10 ³	10	90	1000	60	1.350	0.350	0.0320	W10	
R0990LC08B	800	800	990	11000	605 x 10 ³	12	90	1000	60	1.350	0.350	0.0320	W10	
R0990LC08C	800	800	990	11000	605 x 10 ³	15	90	1000	60	1.350	0.350	0.0320	W10	
R1124NC18J	1800	1800	1124	13500	0.91 x 10 ⁶	50	640	1000	60	1.540	0.379	0.0240	W11	
R1124NC18K	1800	1800	1124	13500	0.91 x 10 ⁶	60	640	1000	60	1.540	0.379	0.0240	W11	
R1124NC18L	1800	1800	1124	13500	0.91 x 10 ⁶	65	640	1000	60	1.540	0.379	0.0240	W11	
R1124NC18M	1800	1800	1124	13500	0.91 x 10 ⁶	70	640	1000	60	1.540	0.379	0.0240	W11	
R1124NC20J	2000	1800	1124	13500	0.91 x 10 ⁶	50	640	1000	60	1.540	0.379	0.0240	W11	
R1124NC20K	2000	1800	1124	13500	0.91 x 10 ⁶	60	640	1000	60	1.540	0.379	0.0240	W11	
R1124NC20L	2000	1800	1124	13500	0.91 x 10 ⁶	65	640	1000	60	1.540	0.379	0.0240	W11	
R1124NC20M	2000	1800	1124	13500	0.91 x 10 ⁶	70	640	1000	60	1.540	0.379	0.0240	W11	
R1124NC21J	2100	1800	1124	13500	0.91 x 10 ⁶	50	640	1000	60	1.540	0.379	0.0240	W11	
R1124NC21K	2100	1800	1124	13500	0.91 x 10 ⁶	60	640	1000	60	1.540	0.379	0.0240	W11	W14 Weight 1300 g
R1124NC21L	2100	1800	1124	13500	0.91 x 10 ⁶	65	640	1000	60	1.540	0.379	0.0240	W11	
R1124NC21M	2100	1800	1124	13500	0.91 x 10 ⁶	70	640	1000	60	1.540	0.379	0.0240	W11	
R1127NC32P	3200	3200	1127	12800	819 x 10 ³	120	3500	1000	60	1.500	0.474	0.0220	W11	
R1127NC32R	3200	3200	1127	12800	819 x 10 ³	140	3500	1000	60	1.500	0.474	0.0220	W11	
R1127NC32S	3200	3200	1127	12800	819 x 10 ³	160	3500	1000	60	1.500	0.474	0.0220	W11	
R1127NC32T	3200	3200	1127	12800	819 x 10 ³	200	3500	1000	60	1.500	0.474	0.0220	W11	
R1127NC34R	3400	3400	1127	12800	819 x 10 ³	160	3500	1000	60	1.500	0.474	0.0220	W11	
R1127NC34T	3400	3400	1127	12800	819 x 10 ³	200	3500	1000	60	1.500	0.474	0.0220	W11	
R1127NC36R	3600	3600	1127	12800	819 x 10 ³	140	3500	1000	60	1.500	0.474	0.0220	W11	
R1127NC36S	3600	3600	1127	12800	819 x 10 ³	160	3500	1000	60	1.500	0.474	0.0220	W11	
R1127NC36T	3600	3600	1127	12800	819 x 10 ³	200	3500	1000	60	1.500	0.474	0.0220	W11	
R1158NC26N	2600	2600	1158	14500	1.05 x 10 ⁶	100	1600	1000	60	1.600	0.400	0.0220	W11	
R1158NC26P	2600	2600	1158	14500	1.05 x 10 ⁶	120	1600	1000	60	1.600	0.400	0.0220	W11	
R1158NC26T	2600	2600	1158	14500	1.05 x 10 ⁶	200	1600	1000	60	1.600	0.400	0.0220	W11	
R1178NC14E	1400	1400	1178	17000	1.45 x 10 ⁶	25	320	1000	60	1.600	0.300	0.0240	W11	
R1178NC14F	1400	1400	1178	17000	1.45 x 10 ⁶	30	320	1000	60	1.600	0.300	0.0240	W11	
R1178NC14G	1400	1400	1178	17000	1.45 x 10 ⁶	35	320	1000	60	1.600	0.300	0.0240	W11	
R1211NC12C	1200	1200	1211	17600	1.548 x 10 ⁶	15	230	1000	60	1.720	0.230	0.0240	W11	
R1211NC12D	1200	1200	1211	17600	1.548 x 10 ⁶	20	230	1000	60	1.720	0.230	0.0240	W11	
R1211NC12E	1200	1200	1211	17600	1.548 x 10 ⁶	25	230	1000	60	1.720	0.230	0.0240	W11	
R1271NC12B	1200	1200	1271	18000	1.62 x 10 ⁶	12	200	1000	60	1.547	0.237	0.0240	W11	
R1271NC12C	1200	1200	1271	18000	1.62 x 10 ⁶	15	200	1000	60	1.547	0.237	0.0240	W11	
R1271NC12D	1200	1200	1271	18000	1.62 x 10 ⁶	20	200	1000	60	1.547	0.237	0.0240	W11	
R1271NC12E	1200	1200	1271	18000	1.62 x 10 ⁶	25	200	1000	60	1.547	0.237	0.0240	W11	
R1275NC18J	1800	1800	1275	15500	1.20 x 10 ⁶	50	940	1000	60	1.207	0.342	0.0240	W11	
R1275NC18K	1800	1800	1275	15500	1.20 x 10 ⁶	60	940	1000	60	1.207	0.342	0.0240	W11	
R1275NC18L	1800	1800	1275	15500	1.20 x 10 ⁶	65	940	1000	60	1.207	0.342	0.0240	W11	W15 Weight 2800 g
R1275NC18M	1800	1800	1275	15500	1.20 x 10 ⁶	70	940	1000	60	1.207	0.342	0.0240	W11	
R1275NC20J	2000	1800	1275	15500	1.20 x 10 ⁶	50	940	1000	60	1.207	0.342	0.0240	W11	
R1275NC20K	2000	1800	1275	15500	1.20 x 10 ⁶	60	940	1000	60	1.207	0.342	0.0240	W11	
R1275NC20L	2000	1800	1275	15500	1.20 x 10 ⁶	65	940	1000	60	1.207	0.342	0.0240	W11	
R1275NC20M	2000	1800	1275	15500	1.20 x 10 ⁶	70	940	1000	60	1.207	0.342	0.0240	W11	
R1275NC21J	2100	1800	1275	15500	1.20 x 10 ⁶	50	940	1000	60	1.207	0.342	0.0240	W11	
R1275NC21K	2100	1800	1275	15500	1.20 x 10 ⁶	60	940	1000	60	1.207	0.342	0.0240	W11	
R1275NC21L	2100	1800	1275	15500	1.20 x 10 ⁶	65	940	1000	60	1.207	0.342	0.0240	W11	
R1275NC21M	2100	1800	1275	15500	1.20 x 10 ⁶	70	940	1000	60	1.207	0.342	0.0240	W11	
R1279NC22J	2200	2200	1279	14800	1.10 x 10 ⁶	50	1250	1000	60	1.440	0.330	0.0220	W11	
R1279NC22K	2200	2200	1279	14800	1.10 x 10 ⁶	60	1250	1000	60	1.440	0.330	0.0220	W11	
R1279NC22L	2200	2200	1279	14800	1.10 x 10 ⁶	65	1250	1000	60	1.440	0.330	0.0220	W11	
R1279NC22M	2200	2200	1279	14800	1.10 x 10 ⁶	70	1250	1000	60	1.440	0.330	0.0220	W11	
R1279NC25J	2500	2500	1279	14800	1.10 x 10 ⁶	50	1250	1000	60	1.440	0.330	0.0220	W11	
R1279NC25K	2500	2500	1279	14800	1.10 x 10 ⁶	60	1250	1000	60	1.440	0.330	0.0220	W11	
R1279NC25L	2500	2500	1279	14800	1.10 x 10 ⁶	65	1250	1000	60	1.440	0.330	0.0220	W11	
R1279NC25M	2500	2500	1279	14800	1.10 x 10 ⁶	70	1250	1000	60	1.440	0.330	0.0220	W11	

Distributed Gate Thyristors

Capsule Types

Part No.	V _{DRM}	V _{RRM}	I _{TAV}	I _{TSM}	I ² t	t _q	Typ. Reverse Recovery Charge			V _{T0}	r _T	R _{thJK}	Fig. No.	Package style
							Q _{rr}	@ T _{JM}	@ -di/dt					
➤ New	V	V	T _K = 55°C A	10 ms ½ sine V _R - ≤ 60% V _{RRM} A	A ² s	@ 200 V/μs μs	μC	A	A/μs	V	mΩ	180° Sine K/W		Outlines on pages O-01...O-30
R1280NC21J	2100	2100	1280	14800	1.10 x 10 ⁶	50	1200	1000	60	1.440	0.330	0.0220	W11	
R1280NC21K	2100	2100	1280	14800	1.10 x 10 ⁶	60	1200	1000	60	1.440	0.330	0.0220	W11	
R1280NC21L	2100	2100	1280	14800	1.10 x 10 ⁶	65	1200	1000	60	1.440	0.330	0.0220	W11	
R1280NC21M	2100	2100	1280	14800	1.10 x 10 ⁶	70	1200	1000	60	1.440	0.330	0.0220	W11	
R1280NC22J	2200	2100	1280	14800	1.10 x 10 ⁶	50	1200	1000	60	1.440	0.330	0.0220	W11	
R1280NC22K	2200	2100	1280	14800	1.10 x 10 ⁶	60	1200	1000	60	1.440	0.330	0.0220	W11	
R1280NC22L	2200	2100	1280	14800	1.10 x 10 ⁶	65	1200	1000	60	1.440	0.330	0.0220	W11	
R1280NC22M	2200	2100	1280	14800	1.10 x 10 ⁶	70	1200	1000	60	1.440	0.330	0.0220	W11	
R1280NC25J	2500	2100	1280	14800	1.10 x 10 ⁶	50	1200	1000	60	1.440	0.330	0.0220	W11	W46 Weight 1200 g
R1280NC25K	2500	2100	1280	14800	1.10 x 10 ⁶	60	1200	1000	60	1.440	0.330	0.0220	W11	
R1280NC25L	2500	2100	1280	14800	1.10 x 10 ⁶	65	1200	1000	60	1.440	0.330	0.0220	W11	
R1280NC25M	2500	2100	1280	14800	1.10 x 10 ⁶	70	1200	1000	60	1.440	0.330	0.0220	W11	
R1331NC10B	1000	1000	1331	18200	1.66 x 10 ⁶	12	200	1000	60	1.450	0.285	0.0220	W11	
R1331NC10C	1000	1000	1331	18200	1.66 x 10 ⁶	15	200	1000	60	1.450	0.285	0.0220	W11	
R1331NC10D	1000	1000	1331	18200	1.66 x 10 ⁶	20	200	1000	60	1.450	0.285	0.0220	W11	
R1331NC12B	1200	1200	1331	18200	1.66 x 10 ⁶	12	200	1000	60	1.450	0.285	0.0220	W11	
R1331NC12C	1200	1200	1331	18200	1.66 x 10 ⁶	15	200	1000	60	1.450	0.285	0.0220	W11	W48 Weight 2000 g
R1331NC12D	1200	1200	1331	18200	1.66 x 10 ⁶	20	200	1000	60	1.450	0.285	0.0220	W11	
R1446NC12C	1200	1200	1446	19500	1.90 x 10 ⁶	15	300	1000	60	1.304	0.199	0.0240	W11	
R1446NC12D	1200	1200	1446	19500	1.90 x 10 ⁶	20	300	1000	60	1.304	0.199	0.0240	W11	
R1446NC12E	1200	1200	1446	19500	1.90 x 10 ⁶	25	300	1000	60	1.304	0.199	0.0240	W11	
R1446NC12F	1200	1200	1446	19500	1.90 x 10 ⁶	30	300	1000	60	1.304	0.199	0.0240	W11	
R1448NC14H	1400	1400	1448	15500	1.20 x 10 ⁶	40	950	1000	60	1.300	0.250	0.0220	W11	
R1448NC14J	1400	1400	1448	15500	1.20 x 10 ⁶	50	950	1000	60	1.300	0.250	0.0220	W11	
R1448NC18H	1800	1800	1448	15500	1.20 x 10 ⁶	40	950	1000	60	1.300	0.250	0.0220	W11	
R1448NC18J	1800	1800	1448	15500	1.20 x 10 ⁶	50	950	1000	60	1.300	0.250	0.0220	W11	
R1448NC20H	2000	2000	1448	15500	1.20 x 10 ⁶	40	950	1000	60	1.300	0.250	0.0220	W11	
R1448NC20J	2000	2000	1448	15500	1.20 x 10 ⁶	50	950	1000	60	1.300	0.250	0.0220	W11	
R1448NC20K	2000	2000	1448	15500	1.20 x 10 ⁶	60	950	1000	60	1.300	0.250	0.0220	W11	
R1448NC20L	2000	2000	1448	15500	1.20 x 10 ⁶	65	950	1000	60	1.300	0.250	0.0220	W11	
R1448NC20M	2000	2000	1448	15500	1.20 x 10 ⁶	70	950	1000	60	1.300	0.250	0.0220	W11	
R1700MC18E	1800	1800	1700	20000	2.0 x 10 ⁶	25	1400	1000	60	1.600	0.250	0.0150	W70	
R1700MC18F	1800	1800	1700	20000	2.0 x 10 ⁶	30	1400	1000	60	1.600	0.250	0.0150	W70	
R1700MC18G	1800	1800	1700	20000	2.0 x 10 ⁶	35	1400	1000	60	1.600	0.250	0.0150	W70	
R1700MC18H	1800	1800	1700	20000	2.0 x 10 ⁶	40	1400	1000	60	1.600	0.250	0.0150	W70	
R1700MC18J	1800	1800	1700	20000	2.0 x 10 ⁶	50	1400	1000	60	1.600	0.250	0.0150	W70	
R1700MC21E	2100	1800	1700	20000	2.0 x 10 ⁶	25	1400	1000	60	1.600	0.250	0.0150	W70	
R1700MC21F	2100	1800	1700	20000	2.0 x 10 ⁶	30	1400	1000	60	1.600	0.250	0.0150	W70	
R1700MC21G	2100	1800	1700	20000	2.0 x 10 ⁶	35	1400	1000	60	1.600	0.250	0.0150	W70	
R1700MC21H	2100	1800	1700	20000	2.0 x 10 ⁶	40	1400	1000	60	1.600	0.250	0.0150	W70	
R1700MC21J	2100	1800	1700	20000	2.0 x 10 ⁶	50	1400	1000	60	1.600	0.250	0.0150	W70	
R1955MC14D ‡	1400	1400	1955	26500	3.51x10 ⁶	20	1000	1000	60	1.460	0.910	0.0150	W70	
R1955MC14E ‡	1400	1400	1955	26500	3.51x10 ⁶	25	1000	1000	60	1.460	0.910	0.0150	W70	
R1955MC14F ‡	1400	1400	1955	26500	3.51x10 ⁶	30	1000	1000	60	1.460	0.910	0.0150	W70	
R1955MC16D ‡	1600	1600	1955	26500	3.51x10 ⁶	20	1000	1000	60	1.460	0.910	0.0150	W70	
R1955MC16E ‡	1600	1600	1955	26500	3.51x10 ⁶	25	1000	1000	60	1.460	0.910	0.0150	W70	
R1955MC16F ‡	1600	1600	1955	26500	3.51x10 ⁶	30	1000	1000	60	1.460	0.910	0.0150	W70	
➤ R2075MC12A ‡	1200	1200	2075	29000	4.21x10 ⁶	10	300	1000	60	1.390	0.167	0.0150	W70	
➤ R2075MC12B ‡	1200	1200	2075	29000	4.21x10 ⁶	12	300	1000	60	1.390	0.167	0.0150	W70	
➤ R2075MC12C ‡	1200	1200	2075	29000	4.21x10 ⁶	15	300	1000	60	1.390	0.167	0.0150	W70	
R2475ZC28M	2800	2800	2475	31000	4.81 x 10 ⁶	70	3900	4000	60	1.504	0.174	0.0110	W13	
R2475ZC28N	2800	2800	2475	31000	4.81 x 10 ⁶	100	3900	4000	60	1.504	0.174	0.0110	W13	
R2475ZC28R	2800	2800	2475	31000	4.81 x 10 ⁶	140	3900	4000	60	1.504	0.174	0.0110	W13	

Distributed Gate Thyristors

Capsule Types

Part No.	V _{DRM} V	V _{RRM} V	I _{TAV} A	I _{TSM} A	I ² t 10 ms ½ sine V _R - ≤ 60% V _{RRM} A ² s	t _q @ 200 V/μs μs	Typ. Reverse Recovery Charge			V _{TO} V	r _T @T _{JM} mΩ	R _{thJK} 180° Sine K/W	Fig. No.	Package style Outlines on pages O-01...O-30
							Q _{rr} μC	@I _{TM} A	@-di/dt A/μs					
R2475ZD28M	2800	2800	2475	31000	4.81 x 10 ⁶	70	3900	4000	60	1.504	0.174	0.0110	W46	
R2475ZD28N	2800	2800	2475	31000	4.81 x 10 ⁶	100	3900	4000	60	1.504	0.174	0.0110	W46	
R2475ZD28R	2800	2800	2475	31000	4.81 x 10 ⁶	140	3900	4000	60	1.504	0.174	0.0110	W46	
R2619ZC18J	1800	1800	2619	33800	5.71 x 10 ⁶	50	1850	4000	60	1.308	0.173	0.0110	W13	
R2619ZC18K	1800	1800	2619	33800	5.71 x 10 ⁶	60	1850	4000	60	1.308	0.173	0.0110	W13	
R2619ZC18L	1800	1800	2619	33800	5.71 x 10 ⁶	65	1850	4000	60	1.308	0.173	0.0110	W13	
R2619ZC20J	2000	2000	2619	33800	5.71 x 10 ⁶	50	1850	4000	60	1.308	0.173	0.0110	W13	
R2619ZC20K	2000	2000	2619	33800	5.71 x 10 ⁶	60	1850	4000	60	1.308	0.173	0.0110	W13	
R2619ZC20L	2000	2000	2619	33800	5.71 x 10 ⁶	65	1850	4000	60	1.308	0.173	0.0110	W13	
R2619ZC21J	2100	2100	2619	33800	5.71 x 10 ⁶	50	1850	4000	60	1.308	0.173	0.0110	W13	
R2619ZC21K	2100	2100	2619	33800	5.71 x 10 ⁶	60	1850	4000	60	1.308	0.173	0.0110	W13	
R2619ZC21L	2100	2100	2619	33800	5.71 x 10 ⁶	65	1850	4000	60	1.308	0.173	0.0110	W13	
R2619ZC25J	2500	2100	2619	33800	5.71 x 10 ⁶	50	1850	4000	60	1.308	0.173	0.0110	W13	
R2619ZC25K	2500	2100	2619	33800	5.71 x 10 ⁶	60	1850	4000	60	1.308	0.173	0.0110	W13	
R2619ZC25L	2500	2100	2619	33800	5.71 x 10 ⁶	65	1850	4000	60	1.308	0.173	0.0110	W13	
R2619ZD18J	1800	1800	2619	33800	5.71 x 10 ⁶	50	1850	4000	60	1.308	0.173	0.0110	W46	
R2619ZD18K	1800	1800	2619	33800	5.71 x 10 ⁶	60	1850	4000	60	1.308	0.173	0.0110	W46	
R2619ZD18L	1800	1800	2619	33800	5.71 x 10 ⁶	65	1850	4000	60	1.308	0.173	0.0110	W46	
R2619ZD20J	2000	2000	2619	33800	5.71 x 10 ⁶	50	1850	4000	60	1.308	0.173	0.0110	W46	
R2619ZD20K	2000	2000	2619	33800	5.71 x 10 ⁶	60	1850	4000	60	1.308	0.173	0.0110	W46	
R2619ZD20L	2000	2000	2619	33800	5.71 x 10 ⁶	65	1850	4000	60	1.308	0.173	0.0110	W46	
R2619ZD21J	2100	2100	2619	33800	5.71 x 10 ⁶	50	1850	4000	60	1.308	0.173	0.0110	W46	
R2619ZD21K	2100	2100	2619	33800	5.71 x 10 ⁶	60	1850	4000	60	1.308	0.173	0.0110	W46	
R2619ZD21L	2100	2100	2619	33800	5.71 x 10 ⁶	65	1850	4000	60	1.308	0.173	0.0110	W46	
R2619ZD25J	2500	2100	2619	33800	5.71 x 10 ⁶	50	1850	4000	60	1.308	0.173	0.0110	W46	
R2619ZD25K	2500	2100	2619	33800	5.71 x 10 ⁶	60	1850	4000	60	1.308	0.173	0.0110	W46	
R2619ZD25L	2500	2100	2619	33800	5.71 x 10 ⁶	65	1850	4000	60	1.308	0.173	0.0110	W46	
R2620ZC22J	2200	2200	2620	33800	5.71 x 10 ⁶	50	2100	4000	60	1.500	0.143	0.0110	W13	
R2620ZC22K	2200	2200	2620	33800	5.71 x 10 ⁶	60	2100	4000	60	1.500	0.143	0.0110	W13	
R2620ZC22L	2200	2200	2620	33800	5.71 x 10 ⁶	65	2100	4000	60	1.500	0.143	0.0110	W13	
R2620ZC25J	2500	2500	2620	33800	5.71 x 10 ⁶	50	2100	4000	60	1.500	0.143	0.0110	W13	
R2620ZC25K	2500	2500	2620	33800	5.71 x 10 ⁶	60	2100	4000	60	1.500	0.143	0.0110	W13	
R2620ZC25L	2500	2500	2620	33800	5.71 x 10 ⁶	65	2100	4000	60	1.500	0.143	0.0110	W13	
R2620ZD22J	2200	2200	2620	33800	5.71 x 10 ⁶	50	2100	4000	60	1.500	0.143	0.0110	W46	
R2620ZD22K	2200	2200	2620	33800	5.71 x 10 ⁶	60	2100	4000	60	1.500	0.143	0.0110	W46	
R2620ZD22L	2200	2200	2620	33800	5.71 x 10 ⁶	65	2100	4000	60	1.500	0.143	0.0110	W46	
R2620ZD25J	2500	2500	2620	33800	5.71 x 10 ⁶	50	2100	4000	60	1.500	0.143	0.0110	W46	
R2620ZD25K	2500	2500	2620	33800	5.71 x 10 ⁶	60	2100	4000	60	1.500	0.143	0.0110	W46	
R2620ZD25L	2500	2500	2620	33800	5.71 x 10 ⁶	65	2100	4000	60	1.500	0.143	0.0110	W46	
R2714ZC14H	1400	1400	2714	35600	6.34 x 10 ⁶	40	1400	4000	60	1.250	0.163	0.0110	W13	
R2714ZC14J	1400	1400	2714	35600	6.34 x 10 ⁶	50	1400	4000	60	1.250	0.163	0.0110	W13	
R2714ZC14K	1400	1400	2714	35600	6.34 x 10 ⁶	60	1400	4000	60	1.250	0.163	0.0110	W13	
R2714ZC18H	1800	1800	2714	35600	6.34 x 10 ⁶	40	1400	4000	60	1.250	0.163	0.0110	W13	
R2714ZC18J	1800	1800	2714	35600	6.34 x 10 ⁶	50	1400	4000	60	1.250	0.163	0.0110	W13	
R2714ZC18K	1800	1800	2714	35600	6.34 x 10 ⁶	60	1400	4000	60	1.250	0.163	0.0110	W13	
R2714ZD14H	1400	1400	2714	35600	6.34 x 10 ⁶	40	1400	4000	60	1.250	0.163	0.0110	W46	
R2714ZD14J	1400	1400	2714	35600	6.34 x 10 ⁶	50	1400	4000	60	1.250	0.163	0.0110	W46	
R2714ZD14K	1400	1400	2714	35600	6.34 x 10 ⁶	60	1400	4000	60	1.250	0.163	0.0110	W46	
R2714ZD18H	1800	1800	2714	35600	6.34 x 10 ⁶	40	1400	4000	60	1.250	0.163	0.0110	W46	
R2714ZD18J	1800	1800	2714	35600	6.34 x 10 ⁶	50	1400	4000	60	1.250	0.163	0.0110	W46	
R2714ZD18K	1800	1800	2714	35600	6.34 x 10 ⁶	60	1400	4000	60	1.250	0.163	0.0110	W46	
R3047TC24K	2400	2400	3047	50000	12.50 x 10 ⁶	60	2100	4000	60	1.580	0.170	0.0080	W14	
R3047TC24L	2400	2400	3047	50000	12.50 x 10 ⁶	65	2100	4000	60	1.580	0.170	0.0080	W14	
R3047TC24M	2400	2400	3047	50000	12.50 x 10 ⁶	70	2100	4000	60	1.580	0.170	0.0080	W14	
R3047TC24N	2400	2400	3047	50000	12.50 x 10 ⁶	100	2100	4000	60	1.580	0.170	0.0080	W14	

Distributed Gate Thyristors

Capsule Types

Part No.	V _{DRM} V	V _{RRM} V	I _{TAV} T _K = 55°C A	I _{TSM} A	I ² t 10 ms ½ sine V _R - ≤ 60% V _{RRM} A ² s	t _q @ 200 V/μs μs	Typ. Reverse Recovery Charge			V _{T0} V	r _T @T _{JM} mΩ	R _{thJK} 180° Sine K/W	Fig. No.	Package style Outlines on pages O-01...O-30
							Q _{rr} @T _{JM} μC	@I _{TM} A	@-di/dt A/μs					
R3047TC28K	2800	2800	3047	50000	12.50 x 10 ⁶	60	2100	4000	60	1.580	0.170	0.0080	W14	
R3047TC28L	2800	2800	3047	50000	12.50 x 10 ⁶	65	2100	4000	60	1.580	0.170	0.0080	W14	
R3047TC28M	2800	2800	3047	50000	12.50 x 10 ⁶	70	2100	4000	60	1.580	0.170	0.0080	W14	
R3047TC28N	2800	2800	3047	50000	12.50 x 10 ⁶	100	2100	4000	60	1.580	0.170	0.0080	W14	
R3047TD24K	2400	2400	3047	50000	12.50 x 10 ⁶	60	2100	4000	60	1.580	0.170	0.0080	W51	
R3047TD24L	2400	2400	3047	50000	12.50 x 10 ⁶	65	2100	4000	60	1.580	0.170	0.0080	W51	
R3047TD24M	2400	2400	3047	50000	12.50 x 10 ⁶	70	2100	4000	60	1.580	0.170	0.0080	W51	
R3047TD24N	2400	2400	3047	50000	12.50 x 10 ⁶	100	2100	4000	60	1.580	0.170	0.0080	W51	
R3047TD28K	2800	2800	3047	50000	12.50 x 10 ⁶	60	2100	4000	60	1.580	0.170	0.0080	W51	
R3047TD28L	2800	2800	3047	50000	12.50 x 10 ⁶	65	2100	4000	60	1.580	0.170	0.0080	W51	
R3047TD28M	2800	2800	3047	50000	12.50 x 10 ⁶	70	2100	4000	60	1.580	0.170	0.0080	W51	
R3047TD28N	2800	2800	3047	50000	12.50 x 10 ⁶	100	2100	4000	60	1.580	0.170	0.0080	W51	
R3370ZC12C	1200	1200	3370	43900	9.64 x 10 ⁶	15	600	4000	60	1.353	0.064	0.0110	W13	
R3370ZC12D	1200	1200	3370	43900	9.64 x 10 ⁶	20	600	4000	60	1.353	0.064	0.0110	W13	
R3370ZC12E	1200	1200	3370	43900	9.64 x 10 ⁶	25	600	4000	60	1.353	0.064	0.0110	W13	
R3559TC16K	1600	1600	3559	38900	7.57 x 10 ⁶	60	1750	4000	60	1.173	0.155	0.0080	W14	
R3559TC16M	1600	1600	3559	38900	7.57 x 10 ⁶	70	1750	4000	60	1.173	0.155	0.0080	W14	
R3559TC16N	1600	1600	3559	38900	7.57 x 10 ⁶	100	1750	4000	60	1.173	0.155	0.0080	W14	
R3559TC20K	2000	2000	3559	38900	7.57 x 10 ⁶	60	1750	4000	60	1.173	0.155	0.0080	W14	
R3559TC20M	2000	2000	3559	38900	7.57 x 10 ⁶	70	1750	4000	60	1.173	0.155	0.0080	W14	
R3559TC20N	2000	2000	3559	38900	7.57 x 10 ⁶	100	1750	4000	60	1.173	0.155	0.0080	W14	
R3559TD16K	1600	1600	3559	38900	7.57 x 10 ⁶	60	1750	4000	60	1.173	0.155	0.0080	W51	
R3559TD16M	1600	1600	3559	38900	7.57 x 10 ⁶	70	1750	4000	60	1.173	0.155	0.0080	W51	
R3559TD16N	1600	1600	3559	38900	7.57 x 10 ⁶	100	1750	4000	60	1.173	0.155	0.0080	W51	
R3559TD20K	2000	2000	3559	38900	7.57 x 10 ⁶	60	1750	4000	60	1.173	0.155	0.0080	W51	
R3559TD20M	2000	2000	3559	38900	7.57 x 10 ⁶	70	1750	4000	60	1.173	0.155	0.0080	W51	
R3559TD20N	2000	2000	3559	38900	7.57 x 10 ⁶	100	1750	4000	60	1.173	0.155	0.0080	W51	
R3636EC16K	1600	1600	3636	38900	7.57 x 10 ⁶	60	1750	4000	60	1.173	0.155	0.0075	W55	
R3636EC16M	1600	1600	3636	38900	7.57 x 10 ⁶	70	1750	4000	60	1.173	0.155	0.0075	W55	
R3636EC16N	1600	1600	3636	38900	7.57 x 10 ⁶	100	1750	4000	60	1.173	0.155	0.0075	W55	
R3636EC20K	2000	2000	3636	38900	7.57 x 10 ⁶	60	1750	4000	60	1.173	0.155	0.0075	W55	
R3636EC20M	2000	2000	3636	38900	7.57 x 10 ⁶	70	1750	4000	60	1.173	0.155	0.0075	W55	
R3636EC20N	2000	2000	3636	38900	7.57 x 10 ⁶	100	1750	4000	60	1.173	0.155	0.0075	W55	
R3708FC45V	4500	3000	3708	50000	12.50 x 10 ⁶	250	8800	4000	60	1.473	0.156	0.0065	W15	
R3708FC45W	4500	3000	3708	50000	12.50 x 10 ⁶	300	8800	4000	60	1.473	0.156	0.0065	W15	
R3708FD45V	4500	3000	3708	50000	12.50 x 10 ⁶	250	8800	4000	60	1.473	0.156	0.0065	W48	
R3708FD45W	4500	3000	3708	50000	12.50 x 10 ⁶	300	8800	4000	60	1.473	0.156	0.0065	W48	
R3968FC24K	2400	2400	4001	66000	21.78 x 10 ⁶	60	2600	4000	60	1.453	0.125	0.0065	W15	
R3968FC24M	2400	2400	4001	66000	21.78 x 10 ⁶	70	2600	4000	60	1.453	0.125	0.0065	W15	
R3968FC24N	2400	2400	4001	66000	21.78 x 10 ⁶	100	2600	4000	60	1.453	0.125	0.0065	W15	
R3968FC28K	2800	2800	4001	66000	21.78 x 10 ⁶	60	2600	4000	60	1.453	0.125	0.0065	W15	
R3968FC28M	2800	2800	4001	66000	21.78 x 10 ⁶	70	2600	4000	60	1.453	0.125	0.0065	W15	
R3968FC28N	2800	2800	4001	66000	21.78 x 10 ⁶	100	2600	4000	60	1.453	0.125	0.0065	W15	
R3968FD24K	2400	2400	4001	66000	21.78 x 10 ⁶	60	2600	4000	60	1.453	0.125	0.0065	W48	
R3968FD24M	2400	2400	4001	66000	21.78 x 10 ⁶	70	2600	4000	60	1.453	0.125	0.0065	W48	
R3968FD24N	2400	2400	4001	66000	21.78 x 10 ⁶	100	2600	4000	60	1.453	0.125	0.0065	W48	
R3968FD28K	2800	2800	4001	66000	21.78 x 10 ⁶	60	2600	4000	60	1.453	0.125	0.0065	W48	
R3968FD28M	2800	2800	4001	66000	21.78 x 10 ⁶	70	2600	4000	60	1.453	0.125	0.0065	W48	
R3968FD28N	2800	2800	4001	66000	21.78 x 10 ⁶	100	2600	4000	60	1.453	0.125	0.0065	W48	

Distributed Gate Thyristors

Asymmetric Thyristors

These devices are available up to a voltage of 2800V. They exhibit very fast turn-on times and are capable of very high values of both critical di/dt and dv/dt. For the device type, they also exhibit high current ratings in excess of 1000A. Asymmetric construction optimizes the forward losses against the turn-off losses and gives the best performance in their voltage class.

Part No.	V_{DRM} V	V_{RRM} V	I_{TAV} $T_K = 55^\circ C$ A	I_{TSM} A	I^2t 10 ms 1/2 sine A^2s	t_{gd} 25°C typ. μs	typ. t_q @ 200 V/ μs μC	$(di/dt)_{cr}$ @ T_{JM} A	$(dv/dt)_{cr}$ @ T_{JM} A/ μs	V_{TO} V	r_T m Ω	T_{JM} °C	R_{thJK} 180° Sine K/W	Fig. No.
A0516YC240	2400	10	516	5700	1.51×10^3	0.5	55	2000	3000	1.630	0.850	125	0.050	W58
A0516YC280	2800	10	516	5700	1.51×10^3	0.5	55	2000	3000	1.630	0.850	125	0.050	W58
A1237NC240	2400	30	1237	18000	1.62×10^6	0.9	30	2000	3000	1.707	0.212	125	0.024	W11
A1237NC280	2800	30	1237	18000	1.62×10^6	0.9	30	2000	3000	1.707	0.212	125	0.024	W11

Outlines on pages O-01...O-30



W11 Weight 510 g



W58 Weight 90 g

Pulse Thyristors

IXYS UK Westcode Ltd are at the forefront of solid state pulsed power technology. offering custom solutions to complex pulsed power problems.

Standard Devices with voltage ratings to 2.5kV, pulsed currents to 50kA peak and di/dt capabilities to over 11kA/ μs are available. Please consult factory for other requirements for voltage ratings up to 4.5kV and pulsed current ratings >200kA.

Part No.	V_{DRM} $V_{GK} = 2 V$ V	V_{RRM} V	V_{DC} $V_{GK} = 2 V$ V	I_{PULSE} kA	$(di/dt)_{cr}$ kA/ μs	V_{TO} V	r_T m Ω	T_{JM} °C	R_{thJC} 180° Sine K/W	Fig. No.	Package style Outlines on pages O-01...O-30
Y200CKC250	2500	2000	1500	20	5	1.216	2.196	125	0.065	W34	
Y500CNC250	2500	2000	1500	50	11	1.755	1.122	125	0.027	W36	



W34 Weight 120 g



W36 Weight 500 g

Gate Turn Off Thyristors

IXYS UK offers a broad range of high specification devices with voltage ratings to 4.5kV (2.8kV DC link) and controllable current ratings of up to 4kA are available to meet the toughest demands in applications such as traction propulsion and auxiliaries. AC industrial drives. FACT's and active VAR controllers. Offering both symmetrical devices for applications with a reverse blocking requirement e.g. current sourced inverters and asymmetric blocking devices for applications where no reverse blocking requirement exists e.g. voltage sourced inverters.

Gate Turn-off Thyristors are still the component of choice when it comes to very high power converters and we remain totally committed to this technology for the foreseeable future, with an active program for continued improvement.

Part No.	V_{DRM} $V_{GK} = -2V$ V	V_{RRM} V	$I_{TGQM} @ C_S$		I_{TAV} $T_K = 55^{\circ}C$ A	I_{TSM} 10 ms 1/2 sine $V_R \leq 10V$ kA	I^2t kA ² s	Typ. Switching Times		V_T $I_T = I_{TGQM}$ V	T_{JM} °C	R_{thJK} 180° Sine K/W	Fig. No.
			A	μC				t_{gt} μs	t_{gq} μs				
➤ G1000NC450	4500	18	1000	2.0	545	8.00	320 x 10 ³	4.5	14	4.0	125	0.0270	W36
G1000QC250	2500	18	1000	1.0	615	8.00	320 x 10 ³	2.8	13	2.5	125	0.0380	W35
G1000QC450	4500	18	1000	1.0	443	6.50	211 x 10 ³	3.0	13	4.0	125	0.0380	W35
G2000HF250	2500	18	2000	4.0	1030	16.00	1.28 x 10 ⁶	3.0	25	2.8	125	0.0220	W85
G2000HF450	4500	18	2000	4.0	890	13.70	938 x 10 ³	4.0	25	3.5	125	0.0220	W85
G2500HF250	2500	18	2500	6.0	1085	16.00	1.28 x 10 ⁶	3.0	25	3.1	125	0.0200	W85
G3000TF250	2500	18	3000	5.0	1690	30.00	4.5 x 10 ⁶	3.5	26	2.5	125	0.0120	W86
G3000TF450	4500	18	3000	6.0	1381	24.00	2.88 x 10 ⁶	4.0	22	4.0	125	0.0120	W86
➤ G4000EF450	4500	18	4000	6.0	1480	26.00	3.38 x 10 ⁶	4.0	30	4.4	125	0.0110	W104
H0500KC200	2000	2000	500	1.0	280	3.00	45 x 10 ³	2.0	5	3.2	125	0.0650	W34
H0500KC20Y	2000	100	500	1.0	280	3.00	45 x 10 ³	2.0	5	3.2	125	0.0650	W34
H0500KC25D	2500	2000	500	1.0	280	3.00	45 x 10 ³	2.0	5	3.2	125	0.0650	W34
H0500KC25Y	2500	100	500	1.0	280	3.00	45 x 10 ³	2.0	5	3.2	125	0.0650	W34
H0700KC140	1400	1400	700	1.5	360	4.00	80 x 10 ³	3.0	5	2.75	125	0.0630	W34
H0700KC14Y	1400	100	700	1.5	360	4.00	80 x 10 ³	3.0	5	2.75	125	0.0630	W34
H0700KC17D	1700	1400	700	1.5	360	4.00	80 x 10 ³	3.0	5	2.75	125	0.0630	W34
H0700KC17Y	1700	100	700	1.5	360	4.00	80 x 10 ³	3.0	5	2.75	125	0.0630	W34
H1200NC200	2000	2000	1200	3.0	670	10.50	550 x 10 ³	3.0	12	3.3	125	0.0270	W36
H1200NC20Y	2000	100	1200	3.0	670	10.50	550 x 10 ³	3.0	12	3.3	125	0.0270	W36
H1200NC25D	2500	2000	1200	3.0	670	10.50	550 x 10 ³	3.0	12	3.3	125	0.0270	W36
H1200NC25Y	2500	100	1200	3.0	670	10.50	550 x 10 ³	3.0	12	3.3	125	0.0270	W36
S0300SR12Y	1200	100	480	1.0	215	3.50	61.2 x 10 ³	3.5	9	2.4	125	0.1300	W87
S0500YC20Y	2000	100	500	1.0	275	4.00	80 x 10 ³	3.5	10	2.5	125	0.0870	W93
S0500YC25Y	2500	100	500	1.0	275	4.00	80 x 10 ³	3.5	10	2.5	125	0.0870	W93
S0500KC200	2000	2000	500	1.0	330	4.00	80 x 10 ³	3.5	10	2.5	125	0.0650	W34
S0500KC20Y	2000	100	500	1.0	330	4.00	80 x 10 ³	3.5	10	2.5	125	0.0650	W34
S0500KC25D	2500	2000	500	1.0	330	4.00	80 x 10 ³	3.5	10	2.5	125	0.0650	W34
S0500KC25Y	2500	100	500	1.0	330	4.00	80 x 10 ³	3.5	10	2.5	125	0.0650	W34
S0700KC140	1400	1400	700	1.5	430	5.00	125 x 10 ³	3.0	10	2.2	125	0.0630	W34
S0700KC14Y	1400	100	700	1.5	430	5.00	125 x 10 ³	3.0	10	2.2	125	0.0630	W34
S0700KC17D	1700	1400	700	1.5	430	5.00	125 x 10 ³	3.0	10	2.2	125	0.0630	W34
S0700KC17Y	1700	100	700	1.5	430	5.00	125 x 10 ³	3.0	10	2.2	125	0.0630	W34
S1000NC300	3000	3000	1000	2.0	600	10.00	500 x 10 ³	5.0	19	3.5	125	0.0270	W36
S1000NC30Y	3000	100	1000	2.0	600	10.00	500 x 10 ³	5.0	19	3.5	125	0.0270	W36
S1000NC36D	3600	2880	1000	2.0	600	10.00	500 x 10 ³	5.0	19	3.5	125	0.0270	W36
S1000NC36Y	3600	100	1000	2.0	600	10.00	500 x 10 ³	5.0	19	3.5	125	0.0270	W36
S1200NC200	2000	2000	1200	3.0	790	13.00	840 x 10 ³	4.5	19	2.7	125	0.0270	W36
S1200NC20Y	2000	100	1200	3.0	790	13.00	840 x 10 ³	4.5	19	2.7	125	0.0270	W36
S1200NC25D	2500	2000	1200	3.0	790	13.00	840 x 10 ³	4.5	19	2.7	125	0.0270	W36
S1200NC25Y	2500	100	1200	3.0	790	13.00	840 x 10 ³	4.5	19	2.7	125	0.0270	W36

➤ = New improved product. Please consult factory for more details



Insulated Gate Bi-polar Transistors

Capsule Types

As a pioneer of Press-Pack IGBT technology, we are able to offer a range of class leading devices with voltage ratings of 2.5kV (1.25kV DC link), 4.5kV (2.8kV DC link) and 6.5kV (3.6kV DC link). The construction of these devices is totally free from wire and solder bonds which all but eliminates the problems of mechanical fatigue associated with conventional modules. Internal stray inductance in both the gate connections and emitter connections is vastly reduced when compared to conventional modules leading to improved ruggedness and short circuit behavior, which is further enhanced by direct cooling of the emitter side of the chip.

These devices are based on a state of the art soft punch through (SPT++) process, which yields exceptional values of $V_{CE(sat)}$ and soft switching behavior despite the high voltage ratings. The devices feature a positive temperature coefficient making them suitable for reliable parallel operation. Devices are available with or without integral anti-parallel diode; a range of complimentary High Power Sonic Diodes optimized for use with these IGBTs are available now with a new generation using improved technology in development. Please contact your representative for more information.

The press-pack IGBTs exhibit exceptional power cycling performance; typically an order of magnitude better than modules, making them highly suited to applications such as metals and traction drive systems where there are repeated cyclic power demands. Press-pack IGBTs have a stable short circuit failure mode which, as well as safety benefits, makes them an ideal choice for medium and high voltage applications where series connection is required. Stable short circuit failure mode allows for the design in of n+ redundancy without additional bypass switches and costly explosion proof enclosures. Typical examples include HVDC, FACTS, Active VAR controllers / compensators and medium voltage drives. In applications above 4MW press-pack IGBTs offer exceptional power density, far exceeding that achievable with comparable modules in multi-level / MMC based converters.

These PPIGBT's are largely backwardly compatible with standard 2.5kV and 4.5kV GTOs in many applications such as AC drives. This makes these parts a simple and economical path to upgrade or refurbish equipment that previously used GTOs, such as locomotives or medium voltage drives. They are suitable for all cooling options including direct liquid immersion. Complementary gate drives, mounting clamps and passive components available.

Part No.	V_{CES}	I_C	I_{CM}	$V_{CE(sat)}$ @ I_C	IGBT Switching		V_F $I_F = I_C$	Diode Recovery			T_{JM}	R_{thJK}		Fig. No.
					Typical E_{ON} J	Typical E_{OFF} J		Typical I_{rm} A	Typical t_{rr} μs	Typical Q_r μC		IGBT K/W	Diode K/W	
➤ New *	V	A	A	V	J	J	V	A	μs	μC	°C	K/W	K/W	
T0360ND25A	2500	360	720	3.07	0.47	0.66	2.25	320	0.7	300	125	0.0541	0.0730	W40
T0500ND25E	2500	500	1000	3.06	0.66	0.92	N/A	N/A	N/A	N/A	125	0.0386	N/A	W40
T0570VD25G	2500	570	1140	3.06	0.75	1.05	2.01	340	1.3	330	125	0.0338	0.0365	W67
T0850VD25E	2500	850	1700	3.04	1.13	1.58	N/A	N/A	N/A	N/A	125	0.0225	N/A	W67
T1200TD25A	2500	1200	2400	3.15	1.50	2.10	2.50	800	0.97	840	125	0.0169	0.0292	W41
T1500TD25E	2500	1500	3000	3.06	1.97	2.76	N/A	N/A	N/A	N/A	125	0.0129	N/A	W41
T2250AD25E	2500	2250	4500	3.03	3.00	4.20	N/A	N/A	N/A	N/A	125	0.0085	N/A	W71
T0160NB45A	4500	160	320	3.45	1.10	1.05	3.90	130	2.5	170	125	0.0730	0.1730	W40
T0240NB45E	4500	240	480	3.60	1.25	1.25	N/A	N/A	N/A	N/A	125	0.0550	N/A	W40
T0340VB45G	4500	340	680	3.50	2.20	2.10	3.50	400	2.3	500	125	0.0365	0.0576	W67
T0510VB45E	4500	510	1020	3.50	3.30	3.15	N/A	N/A	N/A	N/A	125	0.0243	N/A	W67
T0600TB45A	4500	600	1200	3.60	3.70	3.50	3.90	530	1.2	660	125	0.0219	0.0432	W41
T0800TB45E	4500	800	1600	3.50	5.10	4.90	N/A	N/A	N/A	N/A	125	0.0156	N/A	W41
T0800EB45G	4500	800	1600	3.50	5.10	4.90	3.45	700	1.7	1000	125	0.0156	0.0246	W44
T0900EB45A	4500	900	1800	3.60	5.50	5.30	3.90	800	1.6	1000	125	0.0146	0.0288	W44
T1200EB45E	4500	1200	2400	3.60	6.50	6.50	N/A	N/A	N/A	N/A	125	0.0104	N/A	W44
T1600GB45G	4500	1600	3200	3.50	12.00	8.70	3.45	1380	1.7	1970	125	0.0078	0.0123	W45
T1800GB45A	4500	1800	3600	3.60	11.00	10.50	3.90	1600	1.6	2000	125	0.0073	0.0144	W45
T2400GB45E	4500	2400	4800	3.60	13.00	13.00	N/A	N/A	N/A	N/A	125	0.0052	N/A	W45
➤ T0258HF65G	6500	258	516	4.80	1.80	1.45	3.45	300	1.2	410	125	0.0328	0.0567	W95
➤ T0385HF65E	6500	385	770	4.80	2.70	2.18	N/A	N/A	N/A	N/A	125	0.0219	N/A	W95
➤ T0600AF65G	6500	600	1030	4.80	4.20	3.38	3.45	700	1.2	950	125	0.0141	0.0243	W98
➤ T0900AF65E	6500	900	1800	4.80	6.30	5.08	N/A	N/A	N/A	N/A	125	0.0094	N/A	W98
➤ T0900DF65A	6500	900	1800	4.80	6.30	5.08	3.40	950	1.2	1500	125	0.0094	0.0155	W96
➤ T1290BF65A	6500	1290	2580	4.80	9.00	7.30	3.60	1400	1.1	1900	125	0.0066	0.0122	W103
➤ T1375DF65E	6500	1375	2750	4.80	9.60	7.70	N/A	N/A	N/A	N/A	125	0.0062	N/A	W96
➤ T1890BF65E	6500	1890	3780	4.80	13.20	10.60	N/A	N/A	N/A	N/A	125	0.0045	N/A	W103

* Consult factory for details

Outlines on pages O-01...O-30

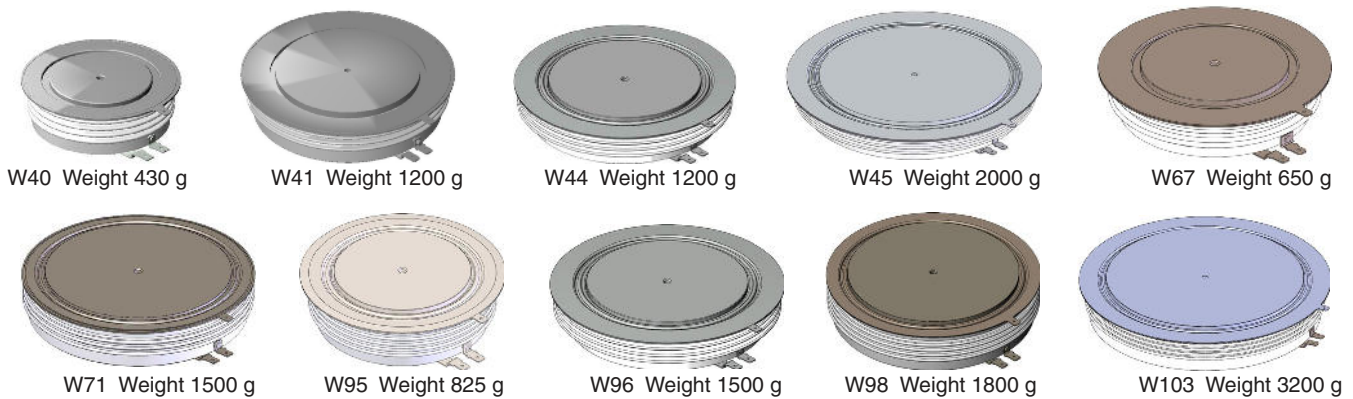

Press-Pack IGBT Gate Drive Units

The C044BG400 IGBT Gate Driver is a low power consumption driver with on board V_{CE} desaturation detection for high reliability application. The driver features a fibre-optic communication interface for drive, status and switching feedback signals. A fully supervised DC/DC converter with EMI filtering, low coupling capacitance and high partial discharge level is integrated into the board. The high voltage collector sense and gate interface are implemented on a separate card to allow close coupling to the IGBT.

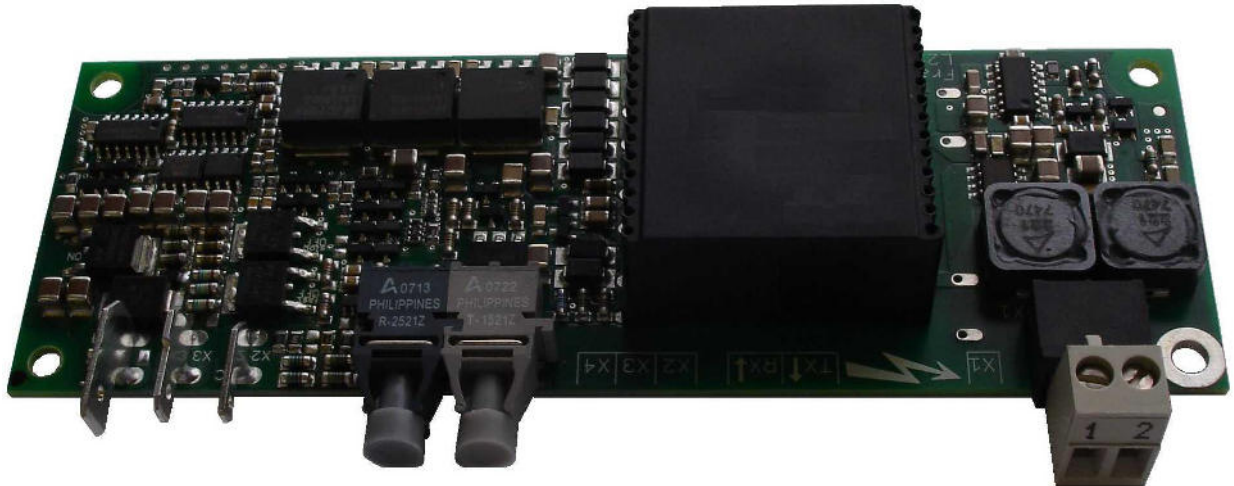

A range of pre-configured boards is available to complement IXYS UK's range of press-pack IGBTs see table below. other applications on request.

Gate Drive Part Number	IGBT Type
C0044BG400SBK	T0160NB45A
C0044BG400SBL	T0240NB45E
C0044BG400SBQ	T0340VB45G
C0044BG400SBA	T0360ND25A
C0044BG400SBB	T0500ND25E
C0044BG400SBE	T0510VB45E
C0044BG400SBF	T0570VD25G
C0044BG400SBM	T0600TB45A
C0044BG400SBG	T0800EB45G
C0044BG400SBN	T0800TB45E
C0044BG400SBH	T0850VD25E
C0044BG400SBP	T0900EB45A
C0044BG400SBR	T1200EB45E
C0044BG400SBC	T1200TD25A
C0044BG400SBD	T1500TD25E
C0044BG400SBJ	T1600GB45G
C0044BG400SBS	T1800GB45A
C0044BG400SBV	T2250AD25E
C0044BG400SBT	T2400GB45E

FEATURES

- High reliability topology
- Designed for ultra low power consumption
- Build in DC/DC-converter with soft start
- Integrated input filter for low EMI
- Separate low impedance path for parasitic EMI currents
- PD-Voltage levels available up to 11 kV on request.
- Low impedance from gate to emitter at start-up and power fail
- Monitoring of all secondary supply voltages
- Monitoring of IGBT switching status (VCE-de-sat detection)
- Soft switch-OFF at V_{CE} -de-sat fault condition
- Fiber-optic links for switching commands and status control
- Low light protection for input signal
- Short-pulse suppression. configurable
- Balanced propagation delay time
- Gate Current up to 44 A
- Optional gate-speed-up capacitors

APPLICATION

- Large and medium drives
- Renewable generation.
- Utilities scale converters

Dual Thyristor Modules

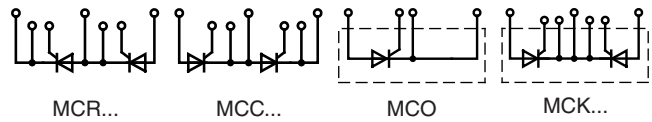

IXYS UK Westcode Ltd. has UL Certification for most modules (Underwriters Laboratories Inc). See the UL Listing.

Part No.	V_{RRM} V_{DRM}	I_{TAV}	@ T_C	I_{TRMS}	I_{TSM} 125°C 10 ms	V_{TO}	r_T	T_{VJM}	R_{thJC}	R_{thCH}	Fig. No.
○ Not for new design									per Die		
➤ New *	V	A	°C	A	A	V	mΩ	°C	K/W	K/W	
➤ MCC160-30io3	3000	169	85	265	3600	1.200	2.300	125	0.110	0.040	W102
➤ MCC160-36io3	3600	169	85	265	3600	1.200	2.300	125	0.110	0.040	W102
➤ MCC220-28io3	2800	237	85	370	4950	0.900	1.100	125	0.110	0.040	W102
➤ MCC265-24io3	2400	283	85	443	6840	0.800	0.700	125	0.110	0.040	W102
MCC320-30io2	3000	327	85	765	5000	1.150	0.800	125	0.062	0.020	W74
MCC320-36io2	3600	327	85	765	5000	1.150	0.800	125	0.062	0.020	W74
➤ MCC325-14io3	1400	348	85	499	7650	0.750	0.500	125	0.110	0.040	W102
➤ MCC325-18io3	1800	348	85	499	7650	0.750	0.500	125	0.110	0.040	W102
➤ MCC380-28io2	2800	395	85	620	8100	1.000	0.650	125	0.062	0.020	W74
MCC431-20io2	2000	429	85	1020	10900	1.000	0.410	125	0.062	0.020	W74
MCC431-22io2	2200	429	85	1020	10900	1.000	0.410	125	0.062	0.020	W74
MCC431-24io2	2400	429	85	1020	10900	1.000	0.410	125	0.062	0.020	W74
○ MCC500-14io1	1400	500	89	1294	16500	0.850	0.270	125	0.062	0.020	W63
○ MCC500-18io1	1800	500	89	1294	16500	0.850	0.270	125	0.062	0.020	W63
○ MCC500-22io1	2200	500	80	1071	14000	0.880	0.460	125	0.062	0.020	W63
○ MCK500-14io1	1400	500	89	1294	16500	0.850	0.270	125	0.062	0.020	W63
○ MCK500-18io1	1800	500	89	1294	16500	0.850	0.270	125	0.062	0.020	W63
○ MCK500-22io1	2200	500	80	1071	14000	0.880	0.460	125	0.062	0.020	W63
MCC501-12io2	1200	503	85	1195	14500	0.850	0.300	125	0.062	0.020	W74
MCC501-14io2	1400	503	85	1195	14500	0.850	0.300	125	0.062	0.020	W74
MCC501-16io2	1600	503	85	1195	14500	0.850	0.300	125	0.062	0.020	W74
MCC501-18io2	1800	503	85	1195	14500	0.850	0.300	125	0.062	0.020	W74
MCC552-12io2	1200	550	85	1300	15800	0.770	0.259	125	0.062	0.020	W74
MCC552-14io2	1400	550	85	1300	15800	0.770	0.259	125	0.062	0.020	W74
MCC552-16io2	1600	550	85	1300	15800	0.770	0.259	125	0.062	0.020	W74
MCC500-30io7	3000	500	85	1181	16200	1.079	0.422	125	0.050	0.016	W88
MCC500-36io7	3600	500	85	1181	16200	1.079	0.422	125	0.050	0.016	W88
MCR500-30io7	3000	500	85	1181	16200	1.079	0.422	125	0.050	0.016	W88
MCR500-36io7	3600	500	85	1181	16200	1.079	0.422	125	0.050	0.016	W88
MCC580-28io7	2800	581	85	1372	18900	0.926	0.313	125	0.050	0.016	W88
MCR580-28io7	2800	581	85	1372	18900	0.926	0.313	125	0.050	0.016	W88
MCC650-24io7	2400	646	85	1542	22100	0.874	0.227	125	0.050	0.016	W88
MCR650-24io7	2400	646	85	1542	22100	0.874	0.227	125	0.050	0.016	W88
MCC720-14io7	1400	719	85	1633	25200	0.823	0.241	125	0.050	0.016	W88
MCC720-18io7	1800	719	85	1633	25200	0.823	0.241	125	0.050	0.016	W88
MCR720-14io7	1400	719	85	1633	25200	0.823	0.241	125	0.050	0.016	W88
MCR720-18io7	1800	719	85	1633	25200	0.823	0.241	125	0.050	0.016	W88

* Consult factory for details

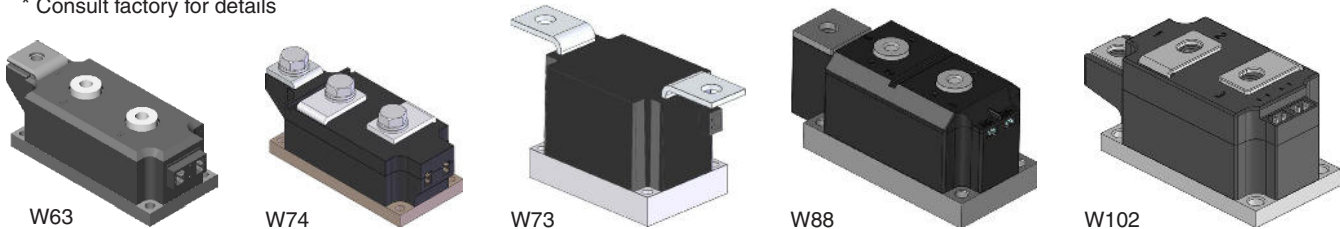

Single Thyristor Modules



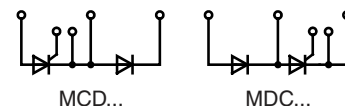

Outlines on pages O-01...O-30

Part No.	V_{RRM} V_{DRM}	I_{TAV}	@ T_C	I_{TRMS}	I_{TSM} 125°C. 10ms	V_{TO}	r_T	T_{VJM}	R_{thJC}	R_{thCH}	Fig. No.
➤ New *	V	A	°C	A	A	V	mΩ	°C	per Die		
									K/W	K/W	
➤ MCO560-30io1	3000	560	85	879	18900	1.050	0.470	125	0.042	0.010	W73
➤ MCO560-36io1	3600	560	85	879	18900	1.050	0.470	125	0.042	0.010	W73
➤ MCO635-28io1	2800	635	85	997	20700	0.950	0.350	125	0.042	0.010	W73
MCO741-22io1	2200	765	85	2110	29000	0.850	0.277	125	0.042	0.010	W73
MCO801-14io1	1400	830	85	2335	30000	0.800	0.240	125	0.042	0.010	W73
MCO801-18io1	1800	830	85	2335	30000	0.800	0.240	125	0.042	0.010	W73

Thyristor / Diode Modules

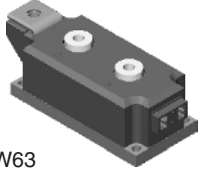
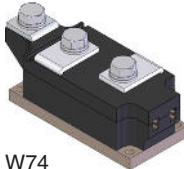

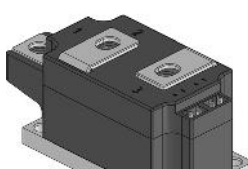
IXYS UK Westcode Ltd. has UL Certification for most modules (Underwriters Laboratories Inc). See the UL Listing.

Part No.	V_{RRM}	I_{TAV}	@ T_C	I_{TRMS}	I_{TSM}	V_{TO}	r_T	T_{VJM}	R_{thJC}	R_{thCH}	Fig. No.	Package style Outline drawings on page O-01...O-30
	V_{DRM}		$^{\circ}C$	A	125 $^{\circ}C$ 10 ms	V	m Ω	$^{\circ}C$	per Die K/W K/W			
○ Not for new design												
➤ New *	V	A	$^{\circ}C$	A	A	V	m Ω	$^{\circ}C$	K/W	K/W		
➤ MCD160-14io3	1400	169	85	265	3600	1.200	2.300	125	0.110	0.0400	W102	
➤ MCD160-18io3	1800	169	85	265	3600	1.200	2.300	125	0.110	0.0400	W102	
➤ MDC160-14io3	1400	169	85	265	3600	1.200	2.300	125	0.110	0.0400	W102	
➤ MDC160-18io3	1800	169	85	265	3600	1.200	2.300	125	0.110	0.0400	W102	
➤ MCD220-28io3	2800	237	85	370	4950	0.900	1.100	125	0.110	0.0400	W102	
➤ MDC220-28io3	2800	237	85	370	4950	0.900	1.100	125	0.110	0.0400	W102	
➤ MCD265-24io3	2400	283	85	443	6840	0.800	0.700	125	0.110	0.0400	W102	
➤ MDC265-24io3	2400	283	85	443	6840	0.800	0.700	125	0.110	0.0400	W102	
MCD320-30io2	3000	327	85	765	5000	1.150	0.800	125	0.065	0.0200	W74	
MCD320-36io2	3600	327	85	765	5000	1.150	0.800	125	0.065	0.0200	W74	
MDC320-30io2	3000	327	85	765	5000	1.150	0.800	125	0.065	0.0200	W74	
MDC320-36io2	3600	327	85	765	5000	1.150	0.800	125	0.065	0.0200	W74	
➤ MCD325-14io3	1400	348	85	499	7650	0.750	0.500	125	0.110	0.0400	W102	
➤ MCD325-18io3	1800	348	85	499	7650	0.750	0.500	125	0.110	0.0400	W102	
➤ MDC325-14io3	1400	348	85	499	7650	0.750	0.500	125	0.110	0.0400	W102	
➤ MDC325-18io3	1800	348	85	499	7650	0.750	0.500	125	0.110	0.0400	W102	
➤ MCD380-28io2	2800	395	85	620	8100	1.000	0.650	125	0.062	0.0200	W74	
➤ MDC380-28io2	2800	395	85	620	8100	1.000	0.650	125	0.062	0.0200	W74	
MCD431-20io2	2000	429	85	1020	10900	1.000	0.410	125	0.062	0.0200	W74	
MCD431-22io2	2200	429	85	1020	10900	1.000	0.410	125	0.062	0.0200	W74	
MCD431-24io2	2400	429	85	1020	10900	1.000	0.410	125	0.062	0.0200	W74	
MDC431-20io2	2000	429	85	1020	10900	1.000	0.410	125	0.062	0.0200	W74	
MDC431-22io2	2200	429	85	1020	10900	1.000	0.410	125	0.062	0.0200	W74	
MDC431-24io2	2400	429	85	1020	10900	1.000	0.410	125	0.062	0.0200	W74	
○ MCD500-14io1	1400	500	89	1294	16500	0.820	0.270	125	0.062	0.0200	W63	
○ MCD500-18io1	1800	500	89	1294	16500	0.820	0.270	125	0.062	0.0200	W63	
○ MCD500-22io1	2200	500	80	1071	14000	0.880	0.460	125	0.062	0.0200	W63	
○ MDC500-14io1	1400	500	89	1294	16500	0.820	0.270	125	0.062	0.0200	W63	
○ MDC500-18io1	1800	500	89	1294	16500	0.820	0.270	125	0.062	0.0200	W63	
○ MDC500-22io1	2200	500	80	1071	14000	0.880	0.460	125	0.062	0.0200	W63	
MCD501-12io2	1200	503	85	1195	14500	0.850	0.300	125	0.062	0.0200	W74	
MCD501-14io2	1400	503	85	1195	14500	0.850	0.300	125	0.062	0.0200	W74	
MCD501-16io2	1600	503	85	1195	14500	0.850	0.300	125	0.062	0.0200	W74	
MCD501-18io2	1800	503	85	1195	14500	0.850	0.300	125	0.062	0.0200	W74	
MDC501-12io2	1200	503	85	1195	14500	0.850	0.300	125	0.062	0.0200	W74	
MDC501-14io2	1400	503	85	1195	14500	0.850	0.300	125	0.062	0.0200	W74	
MDC501-16io2	1600	503	85	1195	14500	0.850	0.300	125	0.062	0.0200	W74	
MDC501-18io2	1800	503	85	1195	14500	0.850	0.300	125	0.062	0.0200	W74	
MCD552-12io2	1200	550	85	1300	15800	0.770	0.259	125	0.062	0.0200	W74	
MCD552-14io2	1400	550	85	1300	15800	0.770	0.259	125	0.062	0.0200	W74	
MCD552-16io2	1600	550	85	1300	15800	0.770	0.259	125	0.062	0.0200	W74	
MDC552-12io2	1200	550	85	1300	15800	0.770	0.259	125	0.062	0.0200	W74	
MDC552-14io2	1400	550	85	1300	15800	0.770	0.259	125	0.062	0.0200	W74	
MDC552-16io2	1600	550	85	1300	15800	0.770	0.259	125	0.062	0.0200	W74	
MCD500-30io7	3000	500	85	1181	16200	1.079	0.422	125	0.050	0.0160	W88	
MCD500-36io7	3600	500	85	1181	16200	1.079	0.422	125	0.050	0.0160	W88	
MDC500-30io7	3000	500	85	1181	16200	1.079	0.422	125	0.050	0.0160	W88	
MDC500-36io7	3600	500	85	1181	16200	1.079	0.422	125	0.050	0.0160	W88	
MCD580-28io7	2800	581	85	1372	18900	0.926	0.313	125	0.050	0.0160	W88	
MDC580-28io7	2800	581	85	1372	18900	0.926	0.313	125	0.050	0.0160	W88	
MCD650-24io7	2400	646	85	1542	22100	0.874	0.227	125	0.050	0.0160	W88	
MDC650-24io7	2400	646	85	1542	22100	0.874	0.227	125	0.050	0.0160	W88	
MCD720-14io7	1400	719	85	1633	25200	0.823	0.241	125	0.050	0.0160	W88	
MCD720-18io7	1800	719	85	1633	25200	0.823	0.241	125	0.050	0.0160	W88	
MDC720-14io7	1400	719	85	1633	25200	0.823	0.241	125	0.050	0.0160	W88	
MDC720-18io7	1800	719	85	1633	25200	0.823	0.241	125	0.050	0.0160	W88	

* Consult factory for details

Dual Diode Modules

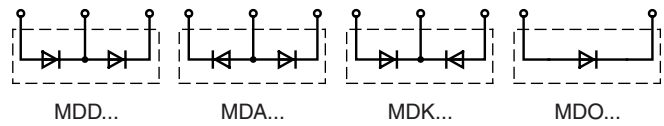

IXYS UK Westcode Ltd. has UL Certification for most modules (Underwriters Laboratories Inc). See the UL Listing.

Part No.	V_{RRM}	I_{FAV}	$@ T_c$	I_{FRMS}	I_{FSM}	V_{TO}	r_T	T_{VJM}	R_{thJC}	R_{thCK}	Fig. No.
	V	A	°C	A	150°C 10 ms A	V	mΩ	°C	per Die K/W K/W		
○ Not for new design											
➤ New *											
➤ MDD275-30N3	3000	291	85	457	4500	0.900	1.570	150	0.1100	0.0400	W102
➤ MDD275-36N3	3600	291	85	457	4500	0.900	1.570	150	0.1100	0.0400	W102
➤ MDA275-30N3	3000	291	85	457	4500	0.900	1.570	150	0.1100	0.0400	W102
➤ MDA275-36N3	3600	291	85	457	4500	0.900	1.570	150	0.1100	0.0400	W102
➤ MDK275-30N3	3000	291	85	457	4500	0.900	1.570	150	0.1100	0.0400	W102
➤ MDK275-36N3	3600	291	85	457	4500	0.900	1.570	150	0.1100	0.0400	W102
➤ MDD410-24N3	2400	441	85	692	7650	0.850	0.450	150	0.1100	0.0400	W102
➤ MDD410-28N3	2800	441	85	692	7650	0.850	0.450	150	0.1100	0.0400	W102
➤ MDA410-24N3	2400	411	85	692	7650	0.850	0.450	150	0.1100	0.0400	W102
➤ MDA410-28N3	2800	441	85	692	7650	0.850	0.450	150	0.1100	0.0400	W102
➤ MDK410-24N3	2400	441	85	692	7650	0.850	0.450	150	0.1100	0.0400	W102
➤ MDK410-28N3	2800	441	85	692	7650	0.850	0.450	150	0.1100	0.0400	W102
➤ MDD510-14N3	1400	544	85	854	10800	0.750	0.250	150	0.1100	0.0400	W102
➤ MDD510-18N3	1800	544	85	854	10800	0.750	0.250	150	0.1100	0.0400	W102
➤ MDA510-14N3	1400	544	85	854	10800	0.750	0.250	150	0.1100	0.0400	W102
➤ MDA510-18N3	1800	544	85	854	10800	0.750	0.250	150	0.1100	0.0400	W102
➤ MDK510-14N3	1400	544	85	854	10800	0.750	0.250	150	0.1100	0.0400	W102
➤ MDK510-18N3	1800	544	85	854	10800	0.750	0.250	150	0.1100	0.0400	W102
○ MDD600-14N1	1400	600	111	1818	21800	0.750	0.200	150	0.0620	0.0200	W63
○ MDD600-18N1	1800	600	111	1818	21800	0.750	0.200	150	0.0620	0.0200	W63
○ MDD600-22N1	2200	600	111	1818	21800	0.750	0.200	150	0.0620	0.0200	W63
○ MDA600-14N1	1400	600	111	1818	21800	0.750	0.200	150	0.0620	0.0200	W63
○ MDA600-18N1	1800	600	111	1818	21800	0.750	0.200	150	0.0620	0.0200	W63
○ MDA600-22N1	2200	600	111	1818	21800	0.750	0.200	150	0.0620	0.0200	W63
○ MDK600-14N1	1400	600	111	1818	21800	0.750	0.200	150	0.0620	0.0200	W63
○ MDK600-18N1	1800	600	111	1818	21800	0.750	0.200	150	0.0620	0.0200	W63
○ MDK600-22N1	2200	600	111	1818	21800	0.750	0.200	150	0.0620	0.0200	W63
MDD630-30N2	3000	632	85	1273	11800	0.800	0.500	150	0.0620	0.0200	W74
MDD630-36N2	3600	632	85	1273	11800	0.800	0.500	150	0.0620	0.0200	W74
MDA630-30N2	3000	632	85	1273	11800	0.800	0.500	150	0.0620	0.0200	W74
MDA630-36N2	3600	632	85	1273	11800	0.800	0.500	150	0.0620	0.0200	W74
MDK630-30N2	3000	632	85	1273	11800	0.800	0.500	150	0.0620	0.0200	W74
MDK630-36N2	3600	632	85	1273	11800	0.800	0.500	150	0.0620	0.0200	W74
MDD 710-22N2	2200	708	85	1440	12750	0.800	0.350	150	0.0620	0.0200	W74
MDD 710-26N2	2600	708	85	1440	12750	0.800	0.350	150	0.0620	0.0200	W74
MDA 710-22N2	2200	708	85	1440	12750	0.800	0.350	150	0.0620	0.0200	W74
MDA 710-26N2	2600	708	85	1440	12750	0.800	0.350	150	0.0620	0.0200	W74
MDK 710-22N2	2200	708	85	1440	12750	0.800	0.350	150	0.0620	0.0200	W74
MDK 710-26N2	2600	708	85	1440	12750	0.800	0.350	150	0.0620	0.0200	W74
MDD 810-12N2	1200	807	85	1661	17250	0.780	0.230	150	0.0620	0.0200	W74
MDD 810-16N2	1600	807	85	1661	17250	0.780	0.230	150	0.0620	0.0200	W74
MDD 810-18N2	1800	807	85	1661	17250	0.780	0.230	150	0.0620	0.0200	W74

* Consult factory for details

Dual Diode Modules

IXYS UK Westcode Ltd. has UL Certification for most modules (Underwriters Laboratories Inc). See the UL Listing.

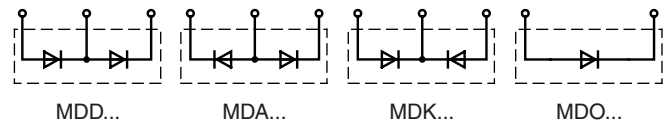

Part No.	V_{RRM}	I_{FAV}	$@ T_C$	I_{FRMS}	I_{FSM}	V_{T0}	r_T	T_{VJM}	R_{thJC}	R_{thCK}	Fig. No.
	V	A	°C	A	150°C 10 ms A	V	mΩ	°C	per Die K/W K/W		
MDA 810-12N2	1200	807	85	1661	17250	0.780	0.230	150	0.0620	0.0200	W74
MDA 810-16N2	1600	807	85	1661	17250	0.780	0.230	150	0.0620	0.0200	W74
MDA 810-18N2	1800	807	85	1661	17250	0.780	0.230	150	0.0620	0.0200	W74
MDK 810-12N2	1200	807	85	1661	17250	0.780	0.230	150	0.0620	0.0200	W74
MDK 810-16N2	1600	807	85	1661	17250	0.780	0.230	150	0.0620	0.0200	W74
MDK 810-18N2	1800	807	85	1661	17250	0.780	0.230	150	0.0620	0.0200	W74
MDD1080-18N7	1800	1080	85	2235	29100	0.782	0.157	150	0.0500	0.0160	W88
MDD1080-24N7	2400	1080	85	2235	29100	0.782	0.157	150	0.0500	0.0160	W88
MDD1080-28N7	2800	1080	85	2235	29100	0.782	0.157	150	0.0500	0.0160	W88
MDA1080-18N7	1800	1080	85	2235	29100	0.782	0.157	150	0.0500	0.0160	W88
MDA1080-24N7	2400	1080	85	2235	29100	0.782	0.157	150	0.0500	0.0160	W88
MDA1080-28N7	2800	1080	85	2235	29100	0.782	0.157	150	0.0500	0.0160	W88
MDK1080-18N7	1800	1080	85	2235	29100	0.782	0.157	150	0.0500	0.0160	W88
MDK1080-24N7	2400	1080	85	2235	29100	0.782	0.157	150	0.0500	0.0160	W88
MDK1080-28N7	2800	1080	85	2235	29100	0.782	0.157	150	0.0500	0.0160	W88

Outlines on pages O-01...O-30

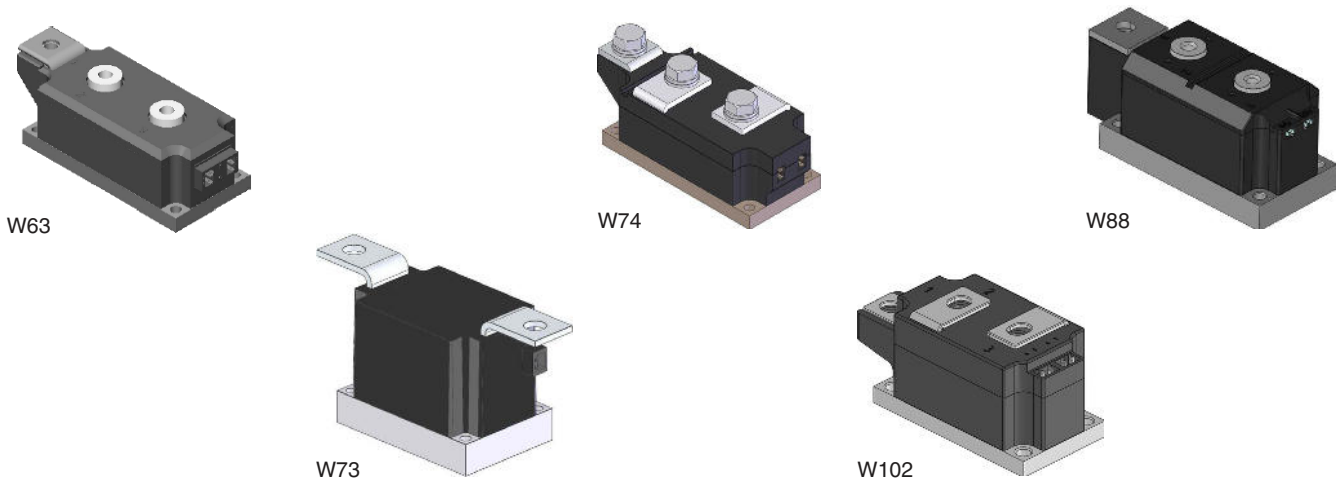

Single Diode Modules

IXYS UK Westcode Ltd. has UL Certification for most modules (Underwriters Laboratories Inc).

Part No.	V_{RRM}	I_{FAV}	$@ T_C$	I_{FRMS}	I_{FSM}	V_{T0}	r_T	T_{VJM}	R_{thJC}	R_{thCK}	Fig. No.
	V	A	°C	A	150°C 10 ms A	V	mΩ	°C	per Die K/W K/W		
➤ New *											
➤ MDO1120-24N1	2400	1189	85	1869	32400	0.8	0.17	150	0.042	0.01	W73
➤ MDO1120-28N1	2800	1189	85	1869	32400	0.8	0.17	150	0.042	0.01	W73
MDO1201-14N1	1400	1520	85	3665	36000	0.8	0.10	160	0.042	0.01	W73
MDO1201-18N1	1800	1520	85	3665	36000	0.8	0.10	160	0.042	0.01	W73
MDO1201-22N1	2200	1520	85	3665	36000	0.8	0.10	160	0.042	0.01	W73

* Consult factory for details

Water Cooled Dual Diode Modules

IXYS UK's range of water cooled modules feature a direct cooled base, with no extra interface to the die allowing for more efficient cooling giving an enhanced average current rating.

IXYS UK Westcode Ltd has UL Certification for most modules (Underwriters Laboratories Inc).
See the UL Listing.

Part No.	V_{RRM}	I_{FAV}	@ T_C	I_{FRMS}	I_{FSM} 150°C 10ms	V_{TO}	r_T	T_{VJM}	R_{thJW} per Die	Fig. No.	Package style Outline drawings on page O-01...O-30
	V	A	°C	A	A	V	mΩ	°C	K/W		
MDD950-14N1W	1400	950	45	1773	21800	0.750	0.200	150	0.0900	W64	
MDD950-18N1W	1800	950	45	1773	21800	0.750	0.200	150	0.0900	W64	
MDD950-22N1W	2200	950	45	1773	21800	0.750	0.200	150	0.0900	W64	
MDA950-14N1W	1400	950	45	1773	21800	0.750	0.200	150	0.0900	W64	
MDA950-18N1W	1800	950	45	1773	21800	0.750	0.200	150	0.0900	W64	
MDA950-22N1W	2200	950	45	1773	21800	0.750	0.200	150	0.0900	W64	
MDK950-14N1W	1400	950	45	1773	21800	0.750	0.200	150	0.0900	W64	
MDK950-18N1W	1800	950	45	1773	21800	0.750	0.200	150	0.0900	W64	
MDK950-22N1W	2200	950	45	1773	21800	0.750	0.200	150	0.0900	W64	

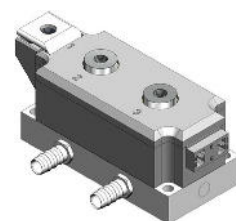

W64

Water Cooled Thyristor/Diode Modules

Part No.	V_{RRM} V_{DRM}	I_{TAV}	@ T_C	I_{TRMS}	I_{TSM} 125°C 10ms	V_{TO}	r_T	T_{VJM}	R_{thJW} per Die	Fig. No.
	V	A	°C	A	A	V	mΩ	°C	K/W	
MCD600-22io1W	2200	600	40	1116	16500	0.880	0.460	125	0.0900	W64
MDC600-22io1W	2200	600	40	1116	16500	0.880	0.460	125	0.0900	W64
MCD700-14io1W	1400	700	42	1331	16500	0.850	0.270	125	0.0900	W64
MCD700-18io1W	1800	700	42	1331	16500	0.850	0.270	125	0.0900	W64
MDC700-14io1W	1400	700	42	1331	16500	0.850	0.270	125	0.0900	W64
MDC700-18io1W	1800	700	42	1331	16500	0.850	0.270	125	0.0900	W64

Water Cooled Dual Thyristor Modules

Part No.	V_{RRM} V_{DRM}	I_{TAV}	@ T_C	I_{TRMS}	I_{TSM} 125°C 10ms	V_{TO}	r_T	T_{VJM}	R_{thJW} per Die	Fig. No.
	V	A	°C	A	A	V	mΩ	°C	K/W	
MCA600-22io1W	2200	600	40	1116	16500	0.880	0.460	125	0.0900	W64
MCC600-22io1W	2200	600	40	1116	16500	0.880	0.460	125	0.0900	W64
MCK600-22io1W	2200	600	40	1116	16500	0.880	0.460	125	0.0900	W64
MCC700-14io1W	1400	700	42	1331	16500	0.850	0.270	125	0.0900	W64
MCC700-18io1W	1800	700	42	1331	16500	0.850	0.270	125	0.0900	W64
MCA700-14io1W	1400	700	42	1331	16500	0.850	0.270	125	0.0900	W64
MCA700-18io1W	1800	700	42	1331	16500	0.850	0.270	125	0.0900	W64
MCK700-14io1W	1400	700	42	1331	16500	0.850	0.270	125	0.0900	W64
MCK700-18io1W	1800	700	42	1331	16500	0.850	0.270	125	0.0900	W64

Power Semiconductor Assemblies From IXYS UK

Power Semiconductor Assemblies

With over 80 years of experience, our dedicated team of talented design engineers can deliver a wide variety of industry leading solutions ranging from simple standard sub-assemblies to complicated multi-megawatt power systems.

IXYS UK's power electronics assemblies group has been an integral part of our core business since the early 1920's when we began production of the first commercially available solid state rectifiers.

Our dedicated team of highly experienced specialists are on hand to provide our customers with first class support on everything from a simple air-cooled rectifier to a highly integrated custom power converter.

Using the latest 3D modelling and simulation techniques, we can significantly reduce the cycle time from concept to fully developed design, minimising risk and identifying opportunity for optimisation early in the project.

With double digit growth in the preceding 5 years, in 2010 we moved into a new 300m² dedicated production facility complemented by a well-equipped power lab. These new facilities, supported by an expanded team of engineers and technicians form the foundations for continued investment and growth in this strategic area of our business.

Standard Assemblies

IXYS UK's standard assemblies also include the new press-pack IGBT 3-level inverters. 3 separate designs are available, a totally independent 3.3kV system, a 6.6kV system and a 10kV system. The 6.6kV and 10kV systems are based on the combination of 2 IGBT stacks and 1 diode stack. Each system benefits from direct water cooling to provide highly effective heat dissipation away from the devices and pre-loaded disc spring clamping to evenly distribute the applied force across the entire surface area of the device.

Also designed into each system is an integrated snubber circuit design and an isolated clamping rod system to limit the occurrence of eddy currents within the unit.

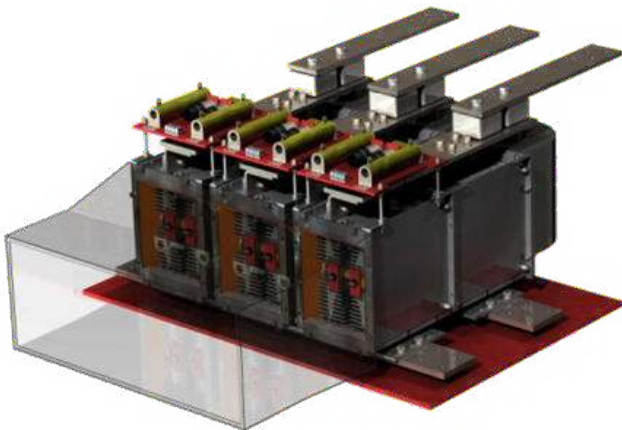

Forced air-cooled three phase fully controlled bridge excitation rectifier for power stations

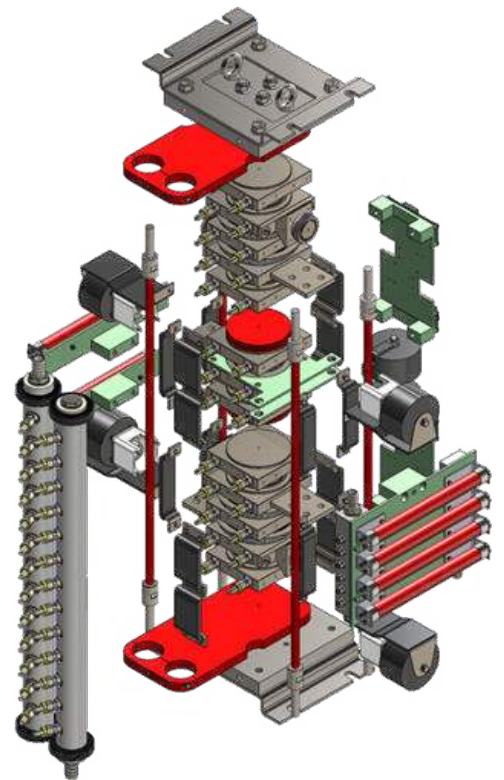

Custom Assemblies

From concept through development and manufacture to after sales support, we believe strongly in working closely with our customer every step of the way – extending our philosophy of teamwork beyond our own organisation.

We understand that good communication and close collaboration help us provide the very best service to our customers.

Using the latest 3D modelling techniques we can visualise concepts and check form, fit and function with virtual prototypes. Also, utilising advanced software packages, IXYS UK can carry out simulation modelling, allowing us to model pressure drops through coolers/manifolds and heat flows through heatsinks.

Pulsed Power

As a pioneer in the development of solid state pulsed power components and systems, we are able to deliver anything from discrete components to fully integrated energy transfer switches. With systems successfully delivering voltage ratings of over 50kV and pulsed currents up to 140kA, we have a wealth of experience at your disposal. Our modular design solutions based on either pulse thyristor or press-pack IGBT technology and integrating control and protection functions provide you with a flexible 'black-box' approach to energy transfer problems.

We are involved with pulsed power on a global basis, working with prestigious research organisations such as CERN, Switzerland as well as medium voltage manufacture for emerging commercial applications such as laser supplies, PUV and PEF sterilisation, magnetisation and metal forming.

Power Semiconductor Assemblies From IXYS UK

Traction Applications

With over 40 years of experience, our dedicated team of design engineers can deliver solutions to a whole range of design problems, ranging from simple trackside rectifiers to complex propulsion converters.

IXYS UK power electronic assemblies group pioneered the early development of solid state converters for traction systems in the late 1950's as part of the Westinghouse brake & signal company. Over the years we have gained an enviable reputation within the rail sector as a solution provider.

Using our experience and broad network of contacts within the industry, we are able to offer assistance in tackling issues such as; component obsolescence, improving power equipment reliability, contract maintenance of power modules, refurbishment of power electronics, upgrades to existing systems and, of course, subcontract manufacture for new projects.

Working systematically to the highest international standards, we can give your equipment a new lease of life and help protect your investment in these valuable assets.

Component obsolescence is becoming a significant problem for the rail sector as equipment design life invariably exceeds that of the modern power electronics components. Our highly skilled team of engineers are able to re-engineer older equipment to incorporate the latest technology whilst maintaining compatibility.

As equipment reached half-life, many of the major power components will reach the end of their useful life resulting in a sharp decline in equipment reliability and availability. In these circumstances we can offer a full overhaul and refurbishment program for your power electronics, from engineering analysis, test and measurement through to delivery and validation of refurbished equipment.

For larger projects such as fleet wide refits, we are able to work within a consortium of specialist international companies to ensure you have the right skills on hand to deliver turnkey solutions to your requirements. This may include system analysis, project management, risk assessment and safety case.

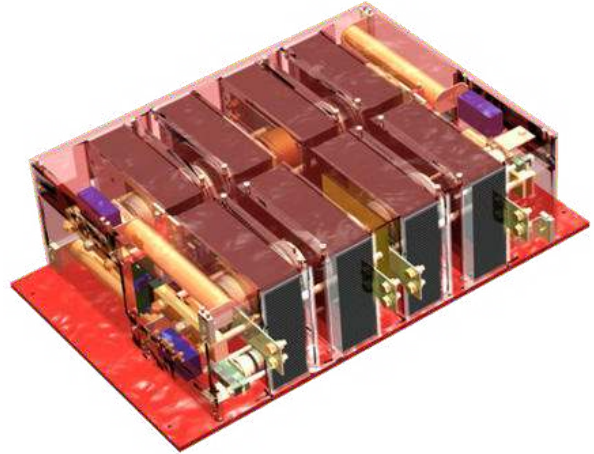

“Powering Transport” from generation to locomotives, our products are hard at work around the globe providing reliable energy control

Power Semiconductor Assemblies From IXYS UK

Silicon Assemblies

A wide range of units is available, incorporating international standard outline silicon semiconductors. IXYS UK products have gained a worldwide reputation for quality in military, industrial and domestic applications.

Standard extruded aluminium heatsink profiles are used for mounting discrete semiconductor devices in various configurations, for example:

- Single-phase diode bridges with current ratings from 70 to 5710 Amps DC
- Single-phase half or fully controlled bridges from 35A to 2200 Amps DC
- Three-phase diode bridges with current ratings from 100 to 7190 Amps DC
- Three-phase half or fully controlled bridges from 45A to 3790 Amps DC
- Hexaphase single way diode assemblies from 200 to 14380 Amps DC
- Hexaphase single way thyristor assemblies from 90 to 7580 Amps DC
- AC regulators, single and three-phase from 40 to 2940 Amps RMS

Included in our standard range are solid-state, water-cooled AC regulators for resistance welding, with ratings from 315 to 3020 Amps RMS.

Also available are water cooled, single and three-phase assemblies from 1200 to 6000 Amps RMS.

All the above ranges are suitable for 440VRMS, 50Hz mains operation.



Beyond Semiconductors

Our flexible manufacturing facility is able to readily adapt to our customer's needs. In addition to power semiconductor assembly, we can offer complementary sub-assemblies to our customer's requirements, such as fuse panels and capacitor banks as well as contract manufacture to your designs.

Application and engineering support

Our highly experienced technical team is on hand to provide our customers with first class support for everything from the application of our range of discrete devices to the design and development of complex systems. We can help you from concept through design to manufacture and test, working closely with you every step of the way.

Components

To complement our range of power semiconductors and assemblies IXYS UK can offer a range of supporting components including:

- Heatsinks
- Coolers
- Mounting clamps
- Ultra-rapid semiconductor protection fuses
- Capacitors
 - Snubbers
 - Rectification
 - Specialist DC link
- Gate drive units

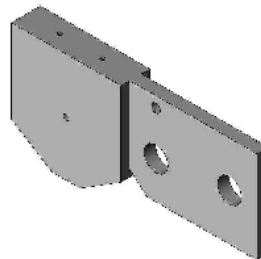

Single phase diode bridges

Approx. total loss $2 \cdot I_{DC}$ @ 25°C

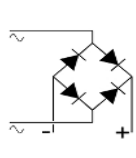
Assembly Part Number	I _{DC} amps Air Forced 2.5m/s			I _{FSM} amps I _{TSM} amps	I ² t A ² s	Dimensions mm				Mass kg	Device Type and Quantity	Heat Sink Type	
	T _a = 25°C	T _a = 35°C	T _a = 45°C			Fig.	W	H	D				
SXB1375B	1375	1303	1230	19500	1.9x10 ⁶	1	382	325	405	20	W2058LC (4)	B(2x83.1x180)	
SXB2096B	2096	1987	1874	33000	5.45x10 ⁶	1	382	325	405	20	W3270NC (4)	B(2x83.1x180)	
SXB3442B	3442	3277	3109	53000	13.5x10 ⁶	2	382	593	405	40	W5696VC (4)	B(2x180)	
SXB4264B	4264	4051	3835	72000	22.5x10 ⁶	2	382	593	405	40	W8405ZC (4)	B(2x180)	

Three phase diode bridges

Approx. total loss $2.5 \cdot I_{DC}$ @ 25°C

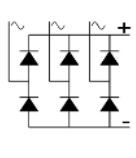
Assembly Part Number	I _{DC} amps Air Forced 2.5m/s			I _{FSM} amps I _{TSM} amps	I ² t A ² s	Dimensions mm				Mass kg	Device Type and Quantity	Heat Sink Type	
	T _a = 25°C	T _a = 35°C	T _a = 45°C			Fig.	W	H	D				
SXB1920G	1920	1822	1721	19500	1.9x10 ⁶	3	548	325	405	30	W2058LC (6)	B(2x83.1x180)	
SXB2939G	2939	2788	2634	33000	5.45x10 ⁶	3	548	325	405	30	W3270NC (6)	B(2x83.1x180)	
SXB4869G	4869	4640	4407	53000	13.5x10 ⁶	4	548	593	405	60	W5696VC (6)	B(2x180)	
SXB5993G	5993	5701	5402	72000	22.5x10 ⁶	4	548	593	405	60	W8405ZC (6)	B(2x180)	

Six phase diode. single way with IPT

Approx. total loss $1.25 \cdot I_{DC}$ @ 25°C

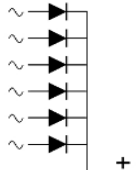
Assembly Part Number	I _{DC} amps Air Forced 2.5m/s			I _{FSM} amps I _{TSM} amps	I ² t A ² s	Dimensions mm				Mass kg	Device Type and Quantity	Heat Sink Type	
	T _a = 25°C	T _a = 35°C	T _a = 45°C			Fig.	W	H	D				
SXB3840HEX	3840	3644	3442	19500	1.9x10 ⁶	5	548	325	395	30	W2058LC (6)	B(2x83.1x180)	
SXB5877HEX	5877	5576	5268	33000	5.45x10 ⁶	5	548	325	395	30	W3270NC (6)	B(2x83.1x180)	
SXB9737HEX	9737	9281	8813	53000	13.5x10 ⁶	6	548	593	395	60	W5696VC (6)	B(2x180)	
SXB11987HEX	11987	11401	10804	72000	22.5x10 ⁶	6	548	593	395	60	W8405ZC (6)	B(2x180)	

Six phase thyristor. single way with IPT

Approx. total loss $1.5 \cdot I_{DC}$ @ 25°C

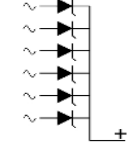
Assembly Part Number	I _{DC} amps Air Forced 2.5m/s			I _{FSM} amps I _{TSM} amps	I ² t A ² s	Dimensions mm				Mass kg	Device Type and Quantity	Heat Sink Type	
	T _a = 25°C	T _a = 35°C	T _a = 45°C			Fig.	W	H	D				
SXB3529HEXT	3529	3244	2949	29600	4.38x10 ⁶	5	548	325	395	30	N1802LC (6)	B(2x83.1x180)	
SXB4649HEXT	4649	4270	3878	37000	6.85x10 ⁶	6	548	593	395	60	N2500VC (6)	B(2x180)	
SXB6240HEXT	6240	5714	5173	64000	20.5x10 ⁶	6	548	593	395	60	N4085ZC (6)	B(2x180)	

Single phase fully controlled bridges

Approx. total loss $2.5 \cdot I_{DC}$ @ 25°C

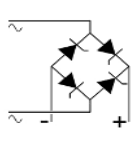
Assembly Part Number	I _{DC} amps Air Forced 2.5m/s			I _{FSM} amps I _{TSM} amps	I ² t A ² s	Dimensions mm				Mass kg	Device Type and Quantity	Heat Sink Type	
	T _a = 25°C	T _a = 35°C	T _a = 45°C			Fig.	W	H	D				
SXB1265FB	1265	1161	1054	29600	4.38x10 ⁶	1	382	325	405	20	N1802NC (4)	B(2x83.1x180)	
SXB1645FB	1645	1508	1367	37000	6.85x10 ⁶	2	382	593	405	40	N2500VC (4)	B(2x180)	
SXB2167FB	2167	1981	1790	64000	20.5x10 ⁶	2	382	593	405	40	N4085ZC (4)	B(2x180)	

Three phase fully controlled bridges

Approx. total loss $3 \cdot I_{DC}$ @ 25°C

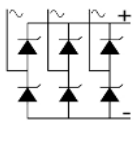
Assembly Part Number	I _{DC} amps Air Forced 2.5m/s			I _{FSM} amps I _{TSM} amps	I ² t A ² s	Dimensions mm				Mass kg	Device Type and Quantity	Heat Sink Type	
	T _a = 25°C	T _a = 35°C	T _a = 45°C			Fig.	W	H	D				
SXB1764FG	1764	1622	1475	29600	4.38x10 ⁶	3	548	325	405	30	N1802NC (6)	B(2x83.1x180)	
SXB2324FG	2324	2135	1939	37000	6.85x10 ⁶	4	548	593	405	60	N2500VC (6)	B(2x180)	
SXB3120FG	3120	2857	2586	64000	20.5x10 ⁶	4	548	593	405	60	N4085ZC (6)	B(2x180)	

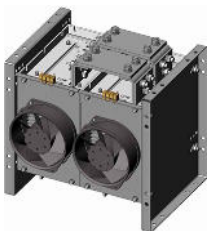

Figure 1



Figure 4



Figure 2

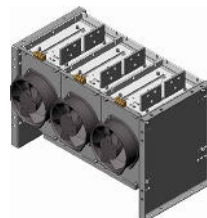

Figure 5



Figure 3

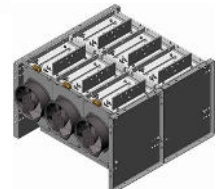

Figure 6

Westack - Modular Solutions

Cooling for each module section is provided by the use of a low noise 115/230 V ac fan which is protected against overloading by an integral thermal cut-out.

Surge suppression and fusing provides reliable and safe operation. Surge suppression (protecting the devices from voltage transients) and high speed fuses (to protect against short circuit) are available. Contact IXYS UK for details.

All plastic components are UL recognised and meet the requirements of the European Union Directive 2002/95/EC covering the restricted use of certain hazardous substances in electrical and electronic equipment.

ISO 9000 provides the standard against which all our products and services are measured.

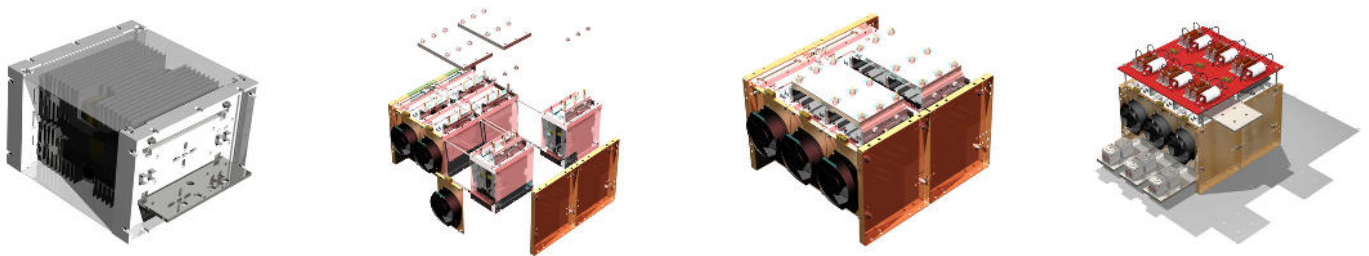

Westack - Modular Solutions are available in 6 standard configurations. others by request.



Figure 1
Weight 20 kg



Figure 2
Weight 40 kg

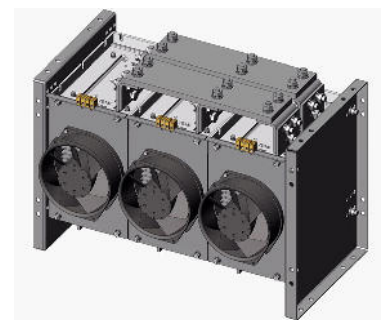

Figure 3
Weight 20 kg

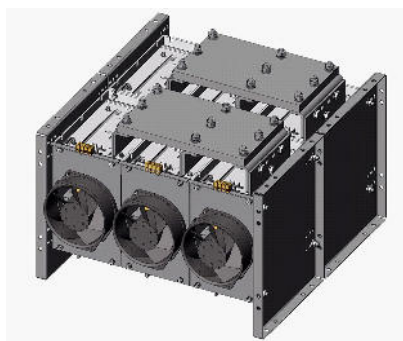

Figure 4
Weight 60 kg

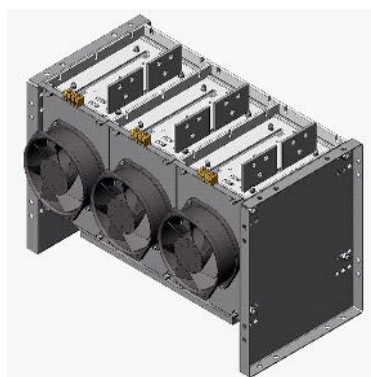

Figure 5
Weight 30 kg

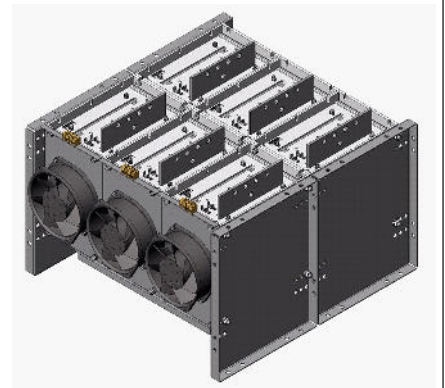

Figure 6
Weight 60 kg

WestackLITE - Modular Solutions

A simple but highly efficient range of stacks incorporating the new **WESPACK** range of phase control thyristors.

Currently available in 3 standard configurations:

AC voltage regulators

Single-phase bridges

Three-phase bridges

These stacks can easily be modified to meet individual customer requirements.

Fully dimensioned drawings are available upon request from the Chippenham Factory.

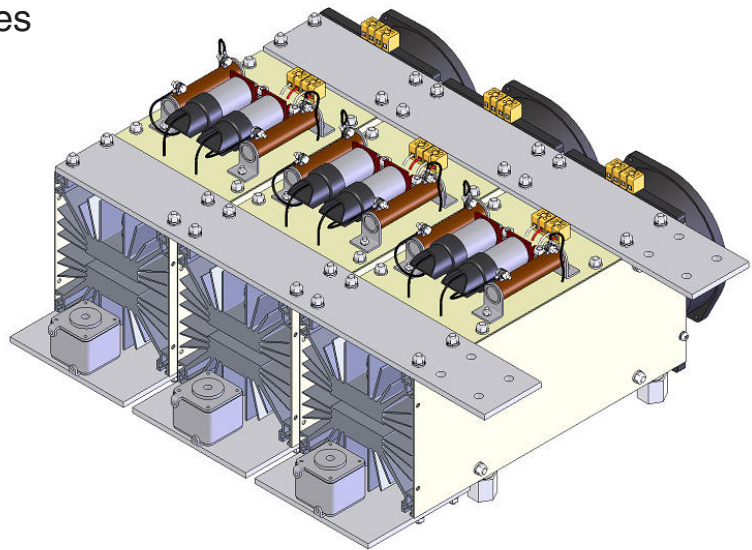

Features and Benefits

WESPACK devices provide the maximum power rating for weight and volume without compromising on quality and reliability.



Cooling is provided by means of a low noise dual voltage (230V/115V) ac fan that is protected against overloading by an integral thermal cut-out.

Surge suppression and fusing can be added to protect the devices from voltage transients and short circuits.

ISO 9000 2000 provides the standard against which all our products and services are measured.

WestackLITE - Modular Solutions

AC regulators

Approx. total loss $1.3 \cdot I_{RMS}$

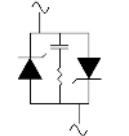
Assembly Part Number	I _{DC} amps Air Forced 5m/s			I _{FSM} amps I _{TSM} amps	I ² t A ² s	Dimensions mm			Mass kg	Device Type and Quantity	Heat Sink Type	
	T _a = 25°C	T _a = 35°C	T _a = 45°C			Fig.	W	H				
SXC1195FR	1195	1098	997	19100	1.82x10 ⁶	1	168	415	212	10	N1806QK (2)	(2x150. 1x330)
SXC1464FR	1464	1348	1227	32400	5.25x10 ⁶	1	168	415	212	10	N2367MK (2)	(2x150. 1x330)
SXC1788FR	1788	1636	1480	50900	12.95x10 ⁶	1	168	415	212	10	N3904HK (2)	(2x150. 1x330)

Single phase fully controlled bridges

Approx. total loss $2.5 \cdot I_{DC}$

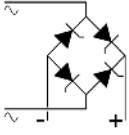
Assembly Part Number	I _{DC} amps Air Forced 2.5m/s			I _{FSM} amps I _{TSM} amps	I ² t A ² s	Dimensions mm			Mass kg	Device Type and Quantity	Heat Sink Type	
	T _a = 25°C	T _a = 35°C	T _a = 45°C			Fig.	W	H				
SXC1076FB	1076	988	897	19100	1.82x10 ⁶	2	330	415	212	20	N1806QK (4)	(2x150. 1x330)
SXC1318FB	1318	1213	1104	32400	5.25x10 ⁶	2	330	415	212	20	N2367MK (4)	(2x150. 1x330)
SXC1609FB	1609	1473	1332	50900	12.95x10 ⁶	2	330	415	212	20	N3904HK (4)	(2x150. 1x330)

Three phase fully controlled bridges

Approx. total loss $3 \cdot I_{DC}$

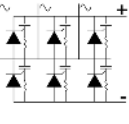
Assembly Part Number	I _{DC} amps Air Forced 2.5m/s			I _{FSM} amps I _{TSM} amps	I ² t A ² s	Dimensions mm			Mass kg	Device Type and Quantity	Heat Sink Type	
	T _a = 25°C	T _a = 35°C	T _a = 45°C			Fig.	W	H				
SXC1517FG	1517	1396	1270	19100	1.82x10 ⁶	3	492	415	212	30	N1806QK (6)	(2x150. 1x330)
SXC1871FG	1871	1725	1573	32400	5.25x10 ⁶	3	492	415	212	30	N2367MK (6)	(2x150. 1x330)
SXC2319FG	2319	2125	1926	50900	12.95x10 ⁶	3	492	415	212	30	N3904HK (6)	(2x150. 1x330)

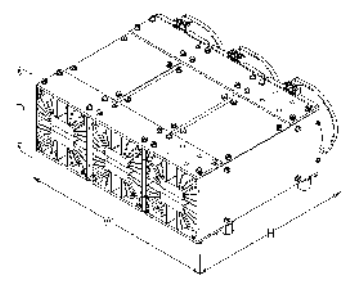
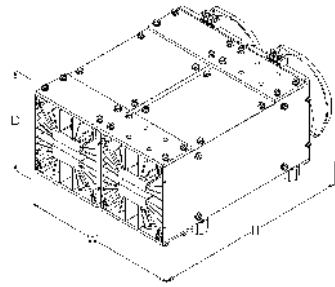
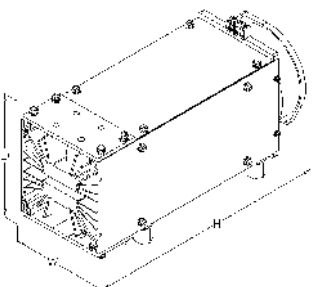
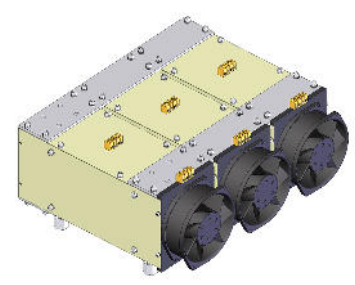
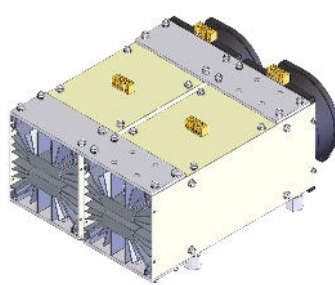
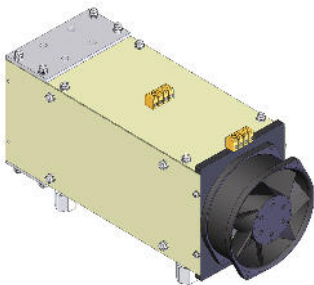
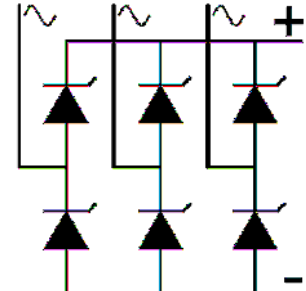
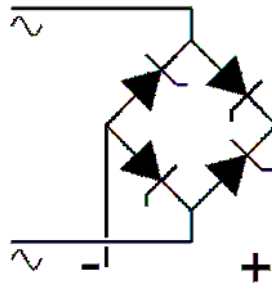
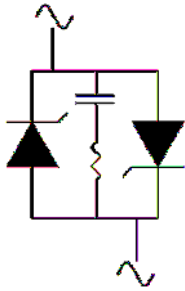

Figure 1
Weight 10 kg

Figure 2
Weight 20 kg

Figure 3
Weight 30 kg

Power Semiconductor Accessories

As part of our continuing commitment to meet our customers' demands, we offer a range of products to support our high power semiconductor devices and our silicon assembly business.

The following pages show a selection of accessories available to our customers, from heatsinks and coolers, to bar or box clamps, to mounting grease!

Part No.	Old Part Number	Accessory
XSGSCX13		Press Pack Semiconductor Mounting Grease - supplied in 1kg tins
XST1000M08P	PTFE1000M8	M8 PTFE tube x 1m length insulation
XST1000M10P	PTFE1000M10	M10 PTFE tube x 1m length insulation
XST1000M12P	PTFE1000M12	M12 PTFE tube x 1m length insulation
XST1000M16P	PTFE1000M16	M16 PTFE tube x 1m length insulation
L0001YC600XXX	n/a	30mm diameter poleface Insulator Capsule
L0001QC600XXX	n/a	38mm diameter poleface Insulator Capsule
L0001NC600XXX	n/a	47mm diameter poleface Insulator Capsule
L0001HC600XXX	n/a	66mm diameter poleface Insulator Capsule
L0001ZF600XXX	n/a	73mm diameter poleface Insulator Capsule
L0001TC600XXX	n/a	75mm diameter poleface Insulator Capsule

Part No.	Old Part Number	Accessory	Type
XSL200D8WRC	U9948	200mm long single Co-Axial cable. Red / White. M5 ring terminal for Ø75 IGBT & below	IGBT
XSL200D8WRCP	U9947	200mm long double Co-Axial cable. Red / White. M5 ring terminal for Ø85 IGBT & above	IGBT
XSL220C2WRT		220mm long twisted pair. Silicone sleeve cable 16/0.2. Red / White. M4 ring terminal	Thyristor
XSL300C2WRP	U9900	300mm long pair. Silicone sleeve cable 16/0.2. Red / White. M4 ring terminal	Thyristor
XSL300C2WS	U9900 (Gate Only)	300mm long gate wire. Silicone sleeve cable 16/0.2. White. M4 ring terminal	Thyristor
XSL350C2WRP	U9723	350mm long pair. Silicone sleeve cable 16/0.2. Red / White. M4 ring terminal	Thyristor
XSL400C2WRP	U9860	400mm long pair. Silicone sleeve cable 16/0.2. Red / White. M4 ring terminal	Thyristor
XSL500C2WRP	U9855	500mm long pair. Silicone sleeve cable 16/0.2. Red / White. M4 ring terminal	Thyristor
XSL600C2WRP	U9775	600mm long pair. Silicone sleeve cable 16/0.2. Red / White. M4 ring terminal	Thyristor
XSL1000C2WRP	U9734/U9801/U9849	1000mm long pair. Silicone sleeve cable 16/0.2. Red / White. M4 ring terminal	Thyristor
XSL1000C2WRT	U9952	1000mm long twisted pair. Silicone sleeve cable 16/0.2. Red / White. M4 ring terminal	Thyristor
XSL1100C2WRT	U9779	1100mm long twisted pair. Silicone sleeve cable 16/0.2. Red / White. M4 ring terminal	Thyristor

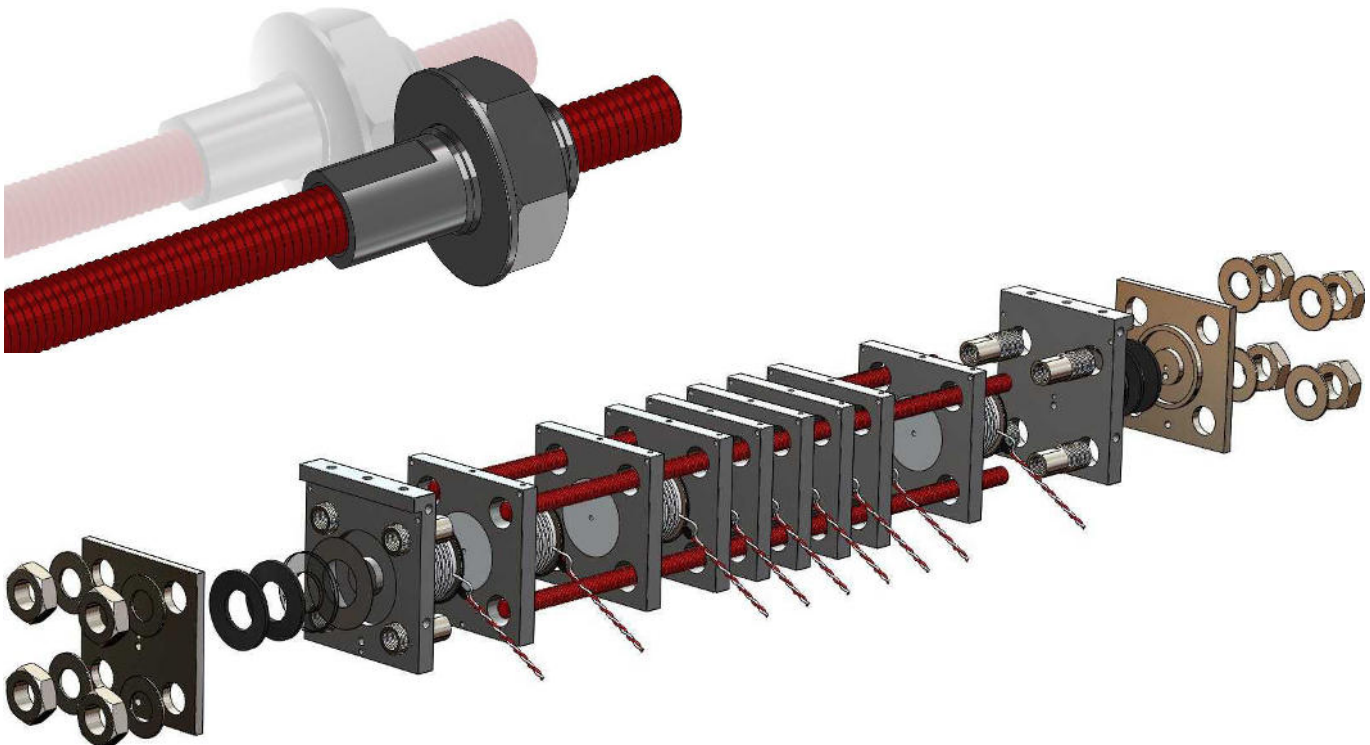

We can supply discrete parts, kits of parts or complete assemblies to satisfy your requirements. Please contact the Chippenham Factory for further information.

Standard base clamp kits for rectifier diodes and phase control thyristors

These Single side cooled square base mounting clamps are suitable for 34 mm to 50 mm pole face devices with clamping force in the range from 1130 Kgf to 2140 Kgf. Suitable for devices with blocking voltages from 400 volts up to 6 KV.

Part No.	Poleface Ref.	Outline Ref.
XK1500CB034M *	34-38	WC64
XK1130SB076M	34-38	WC65
XK2140SB076M	47-50	WC66

Standard part replacements to the obsolete flat-base power silicon diodes types KBN/R. KCN/R & KDN/R. For other voltages and thyristor options please consult factory.

Part No.	Old square base part no.	Base polarity	V_{RRM} V	I_{Iav} $T_C = 100^\circ C$ A	I_{RSM} kA	I^2t A ² s	V_0 V	r_T m Ω	R_{th} K/W	Temp °C	Outline
W1185LC450KBR *	SW45KBR515	Anode	4500	435	10.2	520 x 10 ³	1.000	0.575	0.085	160	WC64
W1185LC450KBN *	SW45KBN515	Cathode	4500	380	10.2	520 x 10 ³	1.000	0.575	0.101	160	WC64
W1411LC360KBR *	SW36KBR595	Anode	3600	505	12.2	744 x 10 ³	0.900	0.388	0.085	160	WC64
W1411LC360KBN *	SW36KBN595	Cathode	3600	445	12.2	744 x 10 ³	0.900	0.388	0.101	160	WC64
W1524LC300KBR *	SW30KBR636	Anode	3000	540	13.4	898 x 10 ³	0.870	0.323	0.085	160	WC64
W1524LC300KBN *	SW30KBN636	Cathode	3000	470	13.4	898 x 10 ³	0.870	0.323	0.101	160	WC64
W1748LC220KBR *	SW22KBR805	Anode	2200	660	13.5	911 x 10 ³	0.870	0.280	0.085	175	WC64
W1748LC220KBN *	SW22KBN805	Cathode	2200	582	13.5	911 x 10 ³	0.870	0.280	0.101	175	WC64
W2058LC120KBR *	SW12KBR935	Anode	1200	760	16.1	1.30 x 10 ⁶	0.790	0.192	0.085	175	WC64
W2058LC120KBN *	SW12KBN935	Cathode	1200	665	16.1	1.30 x 10 ⁶	0.790	0.192	0.101	175	WC64
W1185LC450KCR	SW38KBR515	Anode	4500	455	10.2	520 x 10 ³	1.000	0.575	0.080	160	WC65
W1185LC450KCN	SW45KBN515	Cathode	4500	395	10.2	520 x 10 ³	1.000	0.575	0.097	160	WC65
W1411LC360KCR	SW36KBR595	Anode	3600	530	13.2	756 x 10 ³	0.900	0.388	0.080	160	WC65
W1411LC360KCN	SW36KBN595	Cathode	3600	460	12.3	759 x 10 ³	0.900	0.388	0.097	160	WC65
W1524LC300KCR	SW30KBR635	Anode	3000	565	13.4	898 x 10 ³	0.870	0.323	0.080	160	WC65
W1524LC300KCN	SW30KBN636	Cathode	3000	490	13.4	898 x 10 ³	0.870	0.323	0.097	160	WC65
W1748LC220KCR	SW22KBR805	Anode	2200	690	13.5	911 x 10 ³	0.870	0.280	0.080	175	WC65
W1748LC220KCN	SW22KBN805	Cathode	2200	600	13.5	911 x 10 ³	0.870	0.280	0.097	175	WC65
W2058LC120KCR	SW12KBR935	Anode	1200	800	16.1	1.30 x 10 ⁶	0.790	0.192	0.080	175	WC65
W2058LC120KCN	SW12KBN935	Cathode	1200	690	16.1	1.30 x 10 ⁶	0.790	0.192	0.097	175	WC65
W3082MC450KDR	SB45KDR680	Anode	4500	1115	26.6	3.54 x 10 ⁶	0.923	0.192	0.037	160	WC66
W3082MC450KDN	SB45KDN680	Cathode	4500	1030	26.6	3.54 x 10 ⁶	0.923	0.192	0.041	160	WC66
W3708MC350KDR	SB35KDR820	Anode	3500	1240	33.7	5.68 x 10 ⁶	0.958	0.112	0.037	160	WC66
W3708MC350KDN	SB35KDN820	Cathode	3500	1145	33.7	5.68 x 10 ⁶	0.958	0.112	0.041	160	WC66
W3842MC280KDR	SB25KDR950	Anode	2800	1325	33.5	5.61 x 10 ⁶	0.831	0.118	0.037	160	WC66
W3842MC280KDN	SB25KDN950	Cathode	2800	1225	33.5	5.61 x 10 ⁶	0.831	0.118	0.041	160	WC66
W5636MC150KDR	SB15KDR14C	Anode	1500	2035	43.9	9.64 x 10 ⁶	0.698	0.059	0.037	175	WC66
W5636MC150KDN	SB15KDN14C	Cathode	1500	1875	43.9	9.64 x 10 ⁶	0.698	0.059	0.041	175	WC66

* = Assembly supplied either as kit of parts or sub-assembly with selected diode or thyristor

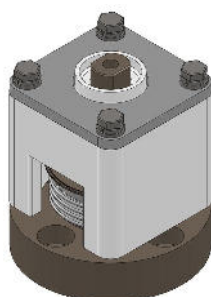

WC64

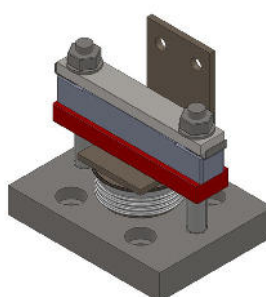

WC65

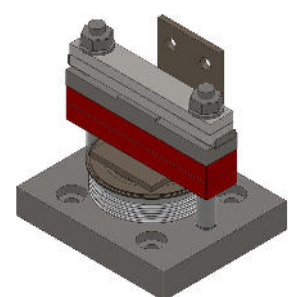

WC66

Standard Bar Clamps

Part No. ○ Not for new design *	Fixing Centres mm	Rod Size	Capsule Device				Outline No.
			Outline	Mounting Surface Diameter mm	Nominal Thickness mm	T _j Max °C	
XK0450DA056M XK0450DT056M XK0450SA056M	65	M8	DO-200AA / TO-200AB	19.0	13.8	190	WC2 WC3 WC1
XK0550DA056M XK0550SA056M	65	M8	GTO	29.5	16.0	190	WC5 WC4
○ XK0900DA056M ○ XK0900DT056M XK0900SA056M	65	M8	Diode / Thyristor	25.1	14.6	190	WC7 WC8 WC6
XK0600DA074M XK0600SA074M	89	M10	Press-Pack IGBTs	47.0	27.0	190	WC10 WC9
XK1000DA074M XK1000SA074M	89	M10	Press-Pack IGBTs	47.0	27.0	190	WC12 WC11
XK1100DA076M	89	M10	DO-200AB / TO-200AC	34.0	26.2	190	WC13
XK1130DA076M XK1130DT076M XK1130SA076M	89	M10	DO-200AB / TO-200AC	34.0	26.2	190	WC15 WC16 WC14
XK1800DA076M XK1800DT076M XK1800SA076M	89	M10	Wespack PCT	38.0	14.0	190	WC18 WC19 WC17
XK2100DA076M XK2100DA076ML XK2100SA076M XK2100SA076ML	89	M10	GTO	47.0	27.0	190 125 190 125	WC21 WC20
○ XK2140DA076M ○ XK2140DA076ML ○ XK2140DT076M ○ XK2140DT076ML XK2140SA076M XK2140SA076ML	89	M10	DO-200 / Thyristor	47.0	26.8	190 125 190 125 190 125	WC23 WC24 WC22
XK2700DA076M XK2700DT076M XK2700SA076M	89	M10	Wespack PCT	50.0	14.0	190	WC26 WC27 WC25
XK2000DA114M XK2000SA114M	132	M12	Press-Pack IGBTs	75.0	26.0	190	WC29 WC28
XK2500DA114M XK2500SA114M	132	M12	Press-Pack IGBTs	75.0	26.0	190	WC31 WC30
XK2500DA116M XK2500DA116ML XK2500SA116M XK2500SA116ML	132	M12	GTO	63.0	26.0	190 125 190 125	WC33 WC32
○ XK3000DA116M ○ XK3000DA116ML XK3000SA116M XK3000SA116ML	132	M12	DO-200AD / Thyristor	63.0	33.0	190 125 190 125	WC35 WC34
XK3500DA116M XK3500DA116ML XK3500SA116M XK3500SA116ML	132	M12	GTO	75.0	26.0	190 125 190 125	WC37 WC36
○ XK4000DA116M ○ XK4000DA116ML XK4000SA116M XK4000SA116ML	132	M12	Diode / Thyristor	73.0	36.8	190 125 190 125	WC39 WC39

Standard Bar Clamps

Part No. ○ Not for new design *	Fixing Centres mm	Rod Size	Outline	Capsule Device			Outline Ref.
				Mounting Surface Diameter mm	Nominal Thickness mm	T _j Max °C	
XK5000DA128M XK5000DA128ML	146	M16	GTO	75.0	26.0	190 125	WC40
XK7000DA128M XK7000DA128ML	146	M16	Diode / Thyristor	75.0	26.6	190 125	WC41
XK3060DA140ML XK3060SA140ML	154	M12	Press-Pack IGBTs	85.1	26.0	125	WC43 WC42
XK9000SA160M XK9000SA160ML	180	M16	Thyristor	99.3	35.8	190 125	WC44
XK9000DA160M XK9000DA160ML	180	M16	Thyristor	99.3	35.8	190 125	WC45
XK6120DA180ML XK6120SA180ML	196	M16	Press-Pack IGBTs	125.0	26.0	125	WC46 WC47

* For new replacement part see page 152

Outline drawings are available from pages O-01...O-30

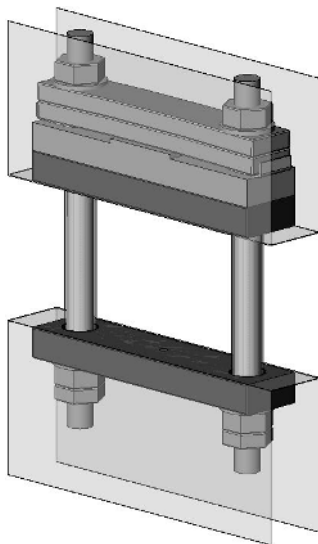

WC 18

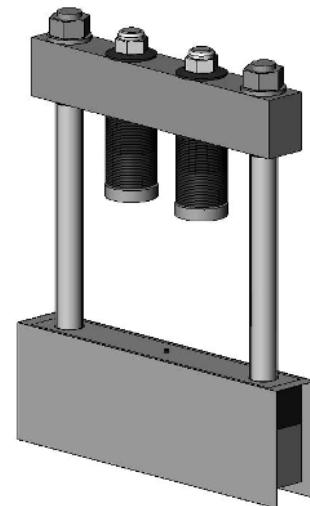

WC 45

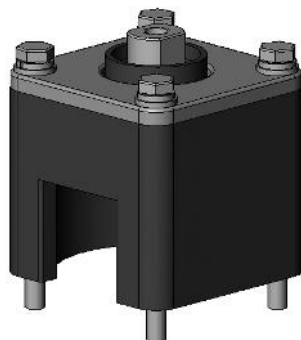

WC 50

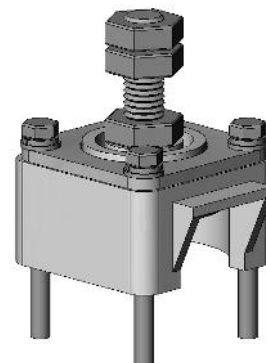

WC 48/49

Bar Clamps - new range!

Range	Part number	### = Force kgf	Max cell dia mm	T _{JMAX} °C	xxx = max Z - dim range mm	Outline
XSK042	XSK####DA042Mxxx	0500/0900	42	190	025-076*	WC58
	XSK####DT042Mxxx	0500/0900	42	190	025-076*	WC59
	XSK####DF042Mxxx	0500/0900	42	190	025-076*	WC60
XSK054	XSK####DA054Mxxx	0900	54	190	025-076*	WC58
	XSK####DT054Mxxx	0900	54	190	025-076*	WC59
	XSK####DF054Mxxx	0900	54	190	025-076*	WC60
XSK056	XSK####DA056Mxxx	0500/0900/1500	56	190	038-120*	WC58
	XSK####DT056Mxxx	0500/0900/1500	56	190	038-120*	WC59
	XSK####DF056Mxxx	0500/0900/1500	56	190	038-120*	WC60
XSK065	XSK####DA065Mxxx	0500/0900/1500	65	190	038-120*	WC58
	XSK####DT065Mxxx	0500/0900/1500	65	190	038-120*	WC59
	XSK####DF065Mxxx	0500/0900/1500	65	190	038-120*	WC60
XSK075	XSK####DA075Mxxx	0900/1500/2200	75	190	038-120*	WC58
	XSK####DT075Mxxx	0900/1500/2200	75	190	038-120*	WC59
	XSK####DF075Mxxx	0900/1500/2200	75	190	038-120*	WC60
XSK087	XSK####DA087Mxxx	1500/2200/3000	87	190	038-120*	WC61
	XSK####DT087Mxxx	1500/2200/3000	87	190	038-120*	WC62
	XSK####DF087Mxxx	1500/2200/3000	87	190	038-120*	WC63
XSK103	XSK####DA103Mxxx	2200/3200/4000	103	190	038-120*	WC61
	XSK####DF103Mxxx	2200/3200/4000	103	190	038-120*	WC63
XSK112	XSK####DA112Mxxx	2800/3200/3800/4500	112	190	038-120*	WC61
	XSK####DF112Mxxx	2800/3200/3800/4500	112	190	038-120*	WC63
XSK120	XSK####DA120Mxxx	3800/4500/5000	120	190	050-120*	WC61
	XSK####DF120Mxxx	3800/4500/5000	120	190	050-120*	WC63
XSK126	XSK####DA126Mxxx	3800/4500/5000	126	190	050-120*	WC61
	XSK####DF126Mxxx	3800/4500/5000	126	190	050-120*	WC63

* contact factory for available sizes

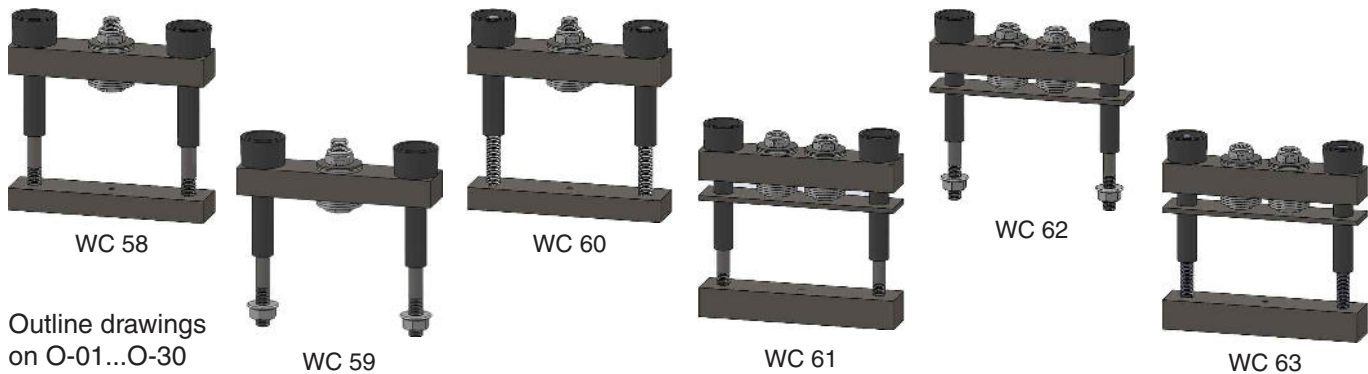

Range	A	A1	B	C	C1	D	E	F	G	H	Fixing
XSK042	69.85	74.89	54.00	15.88	21.04	42.00	8.64	PCF	PCF	12.70	M6
XSK054	82.55	86.04	65.00	15.88	21.04	54.00	8.62	34.93	PCF	12.70	M6
XSK056	95.25	-	70.00	25.40	-	56.00	12.19	PCF	PCF	9.53	M8
XSK065	104.39	-	79.00	25.40	-	65.00	12.19	PCF	PCF	12.70	M8
XSK075	112.78	-	89.00	25.40	-	75.00	12.19	PCF	PCF	12.70	M8
XSK087	127.00	-	102.00	25.40	-	87.00	12.19	PCF	PCF	19.05	M8
XSK103	144.78	154.11	118.00	25.40	36.00	103.00	PCF	PCF	PCF	19.05	M8
XSK112	165.02	-	132.00	25.40	36.00	112.00	16.56	PCF	PCF	25.40	M10
XSK120	172.72	-	140.00	25.40	36.00	120.00	16.56	PCF	PCF	25.40	M10
XSK126	181.10	-	146.00	25.40	36.00	126.00	16.56	PCF	PCF	25.40	M10

PCF = Dimension is dependent on clamp force and cell height. Please consult factory

All dimensions above in mm and relate to outline drawing notation

Bar Clamps Outline Drawings

WC58 DA

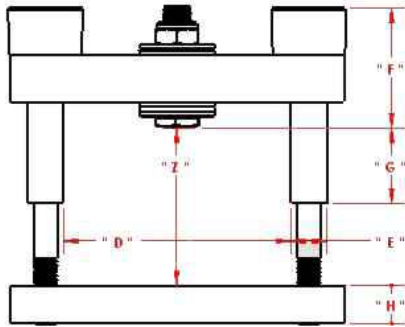
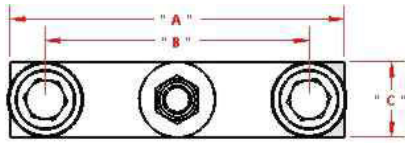

WC59 DT

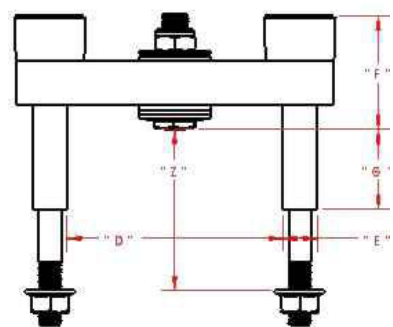
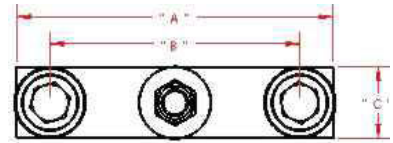

WC60 DF

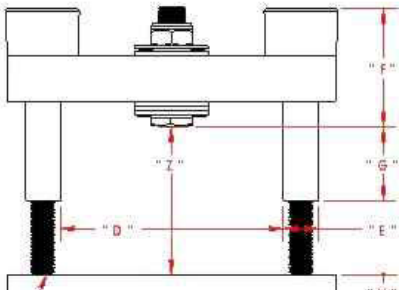
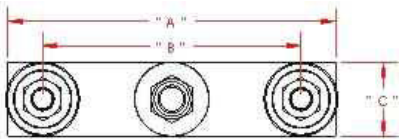

RODS LOCK INTO THE BOTTOM BAR [ALL THE WAY]

WC61 DA

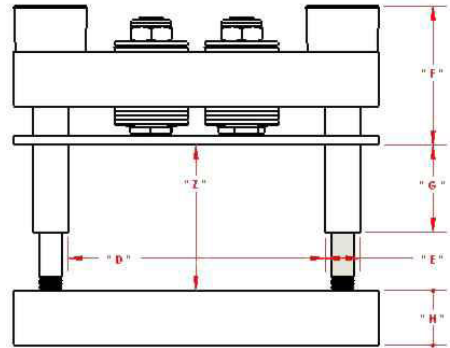
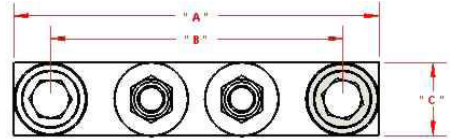

WC62 DT

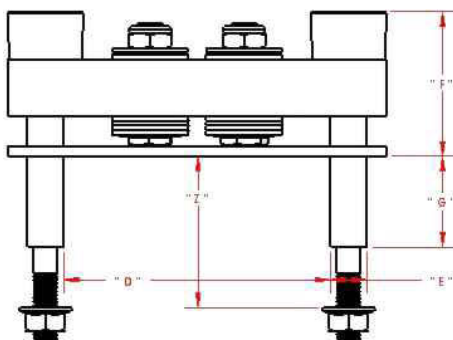
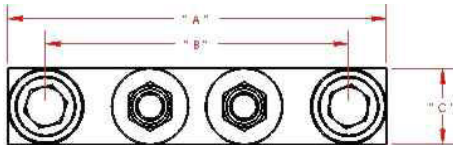

WC63 DF

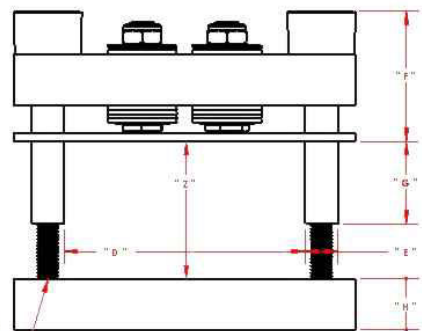
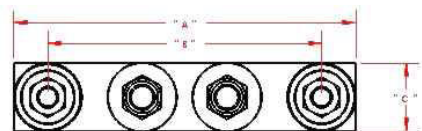

RODS LOCK INTO THE BOTTOM BAR [ALL THE WAY]

Bar Clamps for WESPACK™ and GTO range

Part No.	Rod Size & Length mm	Insulator Size & Length mm	Fixing centres	Pole Face	Clamp Forces	„Z“ mm	„D“ mm	Fig. No.
XSK1500DA076038	M8 x 90	M8 x 60	89	32	10kN to 20kN	38	27.5	WC51
XSK1500DA076076	M8 x 130	M8 x 95				76	62.5	
XSK1500DA076101	M8 x 160	M8 x 120				101	87.6	
XSK2000DA076038	M8 x 95	M8 x 60	89	38	13kN to 20kN	38	25.9	WC52
XSK2000DA076076	M8 x 130	M8 x 95				76	61.0	
XSK2000DA076101	M8 x 160	M8 x 120				101	85.9	
XSK3000DA076038	M8 x 100	M8 x 65	89	50	25kN to 31kN	38	26.2	WC53
XSK3000DA076076	M8 x 130	M8 x 100				76	56.1	
XSK3000DA076101	M8 x 160	M8 x 125				101	86.1	
XSK3400DA076038	M8 x 100	M8 x 65	89	50	27kN to 34kN	38	24.6	WC54
XSK3400DA076076	M8 x 140	M8 x 105				76	64.5	
XSK3400DA076101	M8 x 160	M8 x 130				101	89.7	
XSK3800DA116M076	M10 x 150	M12 x 100	132	66	32kN to 38kN	76	59.7	WC55
XSK3800DA116M101	M10 x 180	M12 x 125				101	84.6	
XSK4400DA116M076	M10 x 150	M12 x 105	132	68	36kN to 44kN	76	63.0	WC56
XSK4400DA116M101	M10 x 180	M12 x 130				101	87.9	
XSK6000DA116M076	M10 x 150	M12 x 105	132	75	50kN to 60kN	76	59.9	WC57
XSK6000DA116M101	M10 x 180	M12 x 130				101	84.8	

Note: 1 Kgf = 9.8 Newtons

T_{JMAX} = 190°C

Outline drawings are available from pages O-01...O-30



WC51

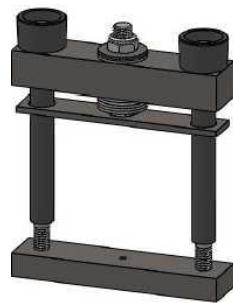

WC52

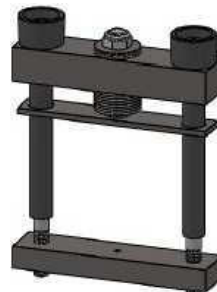

WC53

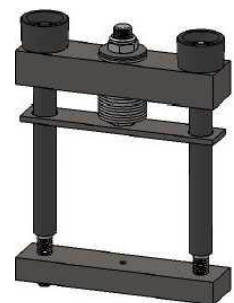

WC54

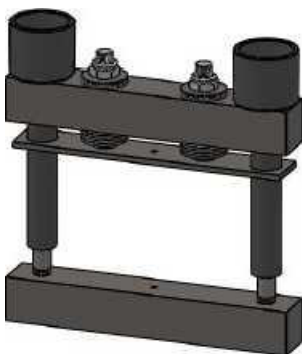

WC55

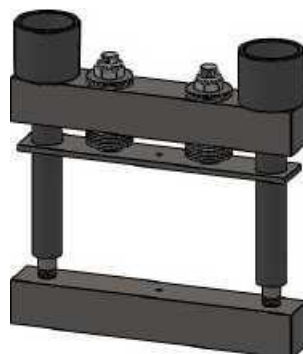

WC56

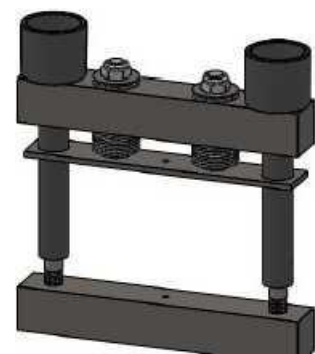

WC57

Box Clamps

Part No.	Moulded Box Style	Fixing Centres mm	Rod Size	Capsule Device			Outline Ref.
				Outline	Mounting Surface Ø mm	Nominal Thickness mm	
➤ XK0450BA019M XK0450BB019M	Injection Compression	50 PCD	M5x50 Bolts	DO-200AA/TO-200AB	19.0	13.8	WC48
XK0450BA025M XK0450BB025M	Injection Compression	50 PCD	M5x50 Bolts	DO-200AA/TO-200AB	25.1	14.6	WC49
➤ XK1000BA025M	Injection	50 PCD	M5x50 Bolts	DO-200AA/TO-200AB	25.1	14.0	WC49
XK1500BA025M	Injection	50 PCD	M5x50 Bolts	DO-200AA/TO-200AB	25.1	14.0	WC49
XK1500BA034M	Injection	70 PCD	M6x50 Bolts	DO-200AB/TO-200AC	34.0	26.2	WC50

Note: 1 Kgf = 9.8 Newtons

Outline drawings are available from pages O-01...O-30

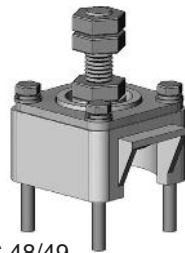

WC 48/49

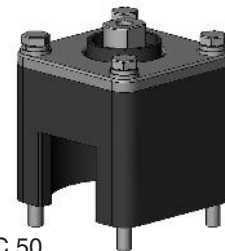

WC 50

Heatsinks

Part No.	Weight Kg/m	Periphery mm	Area mm ²	Fig. No.
XSFGxxxxAN	8.1	1059	2979	WH1
XSFGAxxxxAN	15.6	1682	5867	WH2
XSFHxxxxAN	12.7	1684	4655	WH3
XSFTxxxxAN	20	2065	7573	WH4
XSFTBxxxxAN	29	2467	10905	WH5
XSFTCxxxxAN	28	2544	10561	WH6
SXFLPxxxxAN	30	6620	11172	WH7
SXF46xxxxAN	20	2822	7411	WH8
SXF30xxxxAN	Dimensions 125mm x 125mm x 4 vanes			WH9

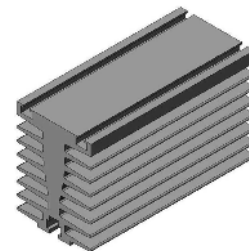

WH1

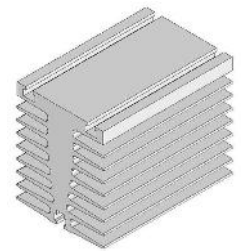

WH2

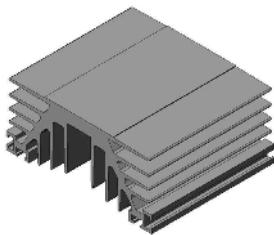

WH3

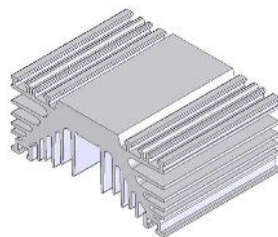

WH4

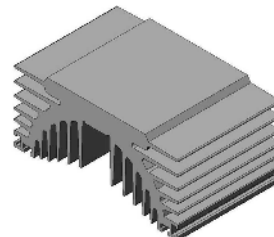

WH5

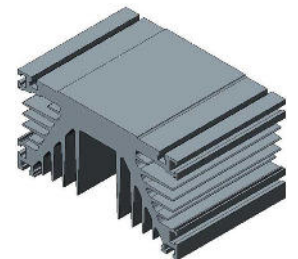

WH6

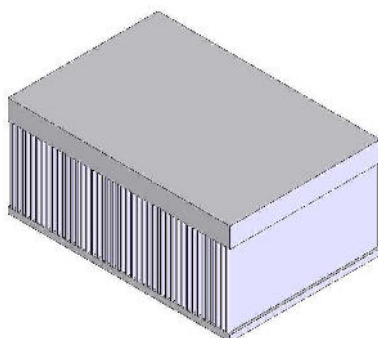

WH7

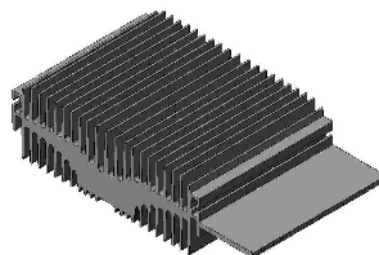

WH8

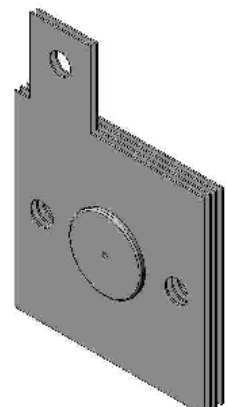

WH9

Coolers

Part No.	Weight Kg	Cooler Thickness mm	Busbar Thickness mm	Description	Fig. No.
XW076NC16A	0.418	16	N/A	47mm WC Cu	WCL2
XW076NC16B	0.612	16	6.4	47mm WC Cu with Busbar (10mm Hose)	WCL1
XW076NC16BS				47mm WC Cu with Busbar + spirol pins fitted (10mm Hose)	WCL1
XW076NC16BT				47mm WC Cu with Busbar + thermostat hole (10mm Hose)	WCL1
XW076NC16C				47mm WC Cu with Busbar (1/2" Hose)	WCL1
XW076NC16CT				47mm WC Cu with Busbar + thermostat hole (1/2" Hose)	WCL1
XW076NC16R	0.581	16	6.35	47mm WC Cu reversed with Busbar	WCL12
XW076NC16W	0.400	16	N/A	47mm WC Cu reversed	WCL13
XW116ZC20A	1.300	20	N/A	73mm WC Cu	WCL4
XW116ZC20B	1.750	20	10	73mm WC Cu with Busbar	WCL3
XW116ZC20C	2.120	20	10	73mm WC Cu with alt. Busbar	WCL5
XW116ZC20R	1.672	20	10	73mm WC Cu reversed with Busbar	WCL14
XW116ZC20W	1.119	20	N/A	73mm WC Cu reversed	WCL15
XW127EN15A	0.375	15	N/A	85mm WC Al Nitride	WCL8
XW127EN15B				85mm WC Al Nitride without holes	WCL8
XW127EC25A	1.650	25	N/A	85mm WC Cu Helix	WCL16
XW127EC25B	2.200	25	8	85mm WC Cu with Busbar Helix	WCL17
XW127EA25A	0.500	25	N/A	85mm WC Al Helix	WCL16
XW127EA25B	0.650	25	8	85mm WC Al with Busbar Helix	WCL17
XW160FC25A	3.620	25	N/A	100mm WC Cu	WCL6
XW160FC25B	4.520	25	10	100mm WC Cu with Busbar	WCL7
XW180GC34A	4.920	34	N/A	125mm WC Cu Helix	WCL11
XW180GC34B	5.950	34	10	125mm WC Cu with Busbar Helix	WCL10
XW180GA34A	1.500	34	N/A	125mm WC Al Helix	WCL11
XW180GA34B	1.800	34	10	125mm WC Al with Busbar Helix	WCL10
XW180GN25A	0.920	25	N/A	125mm WC Al Nitride Helix	WCL18
XW270QA25A	2.941	25	N/A	270 x 190mm WC Al Cold Plate	WCL9

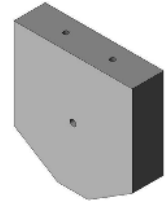

WCL2

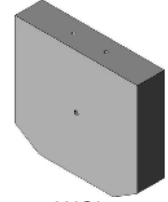

WCL4



WCL8

Outlines on pages O-01...O-30

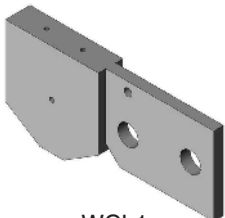

WCL1

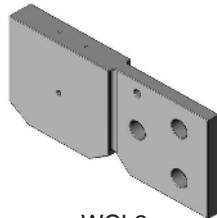

WCL3

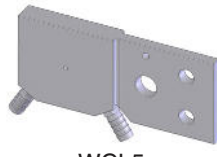

WCL5

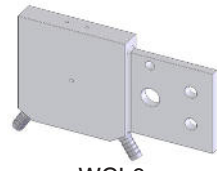

WCL6



WCL7

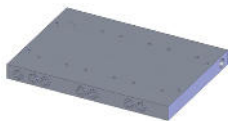

WCL9 -WS65

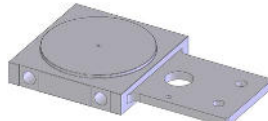

WCL10



WCL11

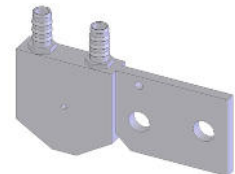

WCL12 -WS71-1

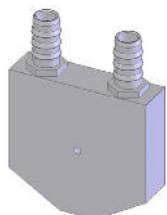

WCL13 -WS71-2

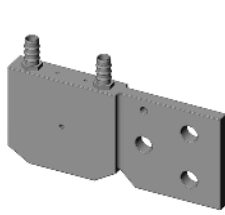

WCL14 -WS72-1

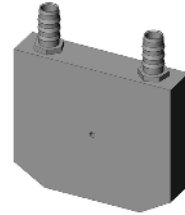

WCL15 -WS72-2

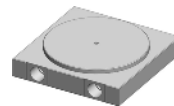

WCL16

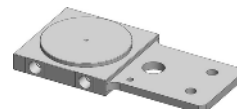

WCL17

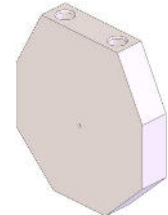

WCL18

Part No.	Cooler Accessories
XSNM12H10S	M12 Cooler Connection. 10mm Hose & Stainless Steel material
XSNM12H12S	M12 Cooler Connection. 12mm Hose & Stainless Steel material
XSNM10H15P	M10 Cooler Connection. 15mm Hose & Plastic Material

Snubber Capacitors - New Range

A new addition for 2013. IXYS UK's new range of snubber capacitors. These capacitors have a low series resistance, high pulse strength and low self-inductance of 15nH; they also have very good self-healing characteristics without loss of capacitance. These capacitors consist of a flame retardant plastic can filled with solid resin to ensure reliable operation even under the most extreme environmental conditions.

Part No.	Capacitance	Series Resistance	RMS Current	Peak Current	Peak Surge Current	DC Voltage	AC Voltage	Non-repetitive Surge voltage	Fig.	Dia-meter D1	Length L1
	CN	ESR	I_{RMS}	I_{PK}	I_S	V_{DC}	V_{AC}	V_S			
	μF	$m\Omega$	A	kA	kA	V	V	V		mm	mm
E53.H59-471T1W	0.47	2.90	20	0.70	2.10	3750	2100	5625	T1	55	59
E53.H59-102T1W	1.00	1.60	40	0.35	1.75	3200	1050	4800	T1	55	59
E53.H59-152T1W	1.50	2.40	32	0.27	1.35	2800	700	4200	T1	55	59
E53.H59-252T1W	2.50	1.80	40	0.37	1.10	2250	700	3375	T1	55	59
E53.M59-252T2W	2.50	0.65	75	0.90	4.50	3200	1050	4800	T2	75	59
E53.R11-302T21W	3.00	1.20	125	2.10	6.30	5000	2100	7500	T1	115	110
E53.H59-332T1W	3.30	1.60	40	0.42	1.20	2000	700	3000	T1	55	59
E53.M59-332T2W	3.30	1.10	60	0.60	3.00	2800	700	4200	T2	75	59
E53.P59-402T2W	4.00	0.50	80	1.50	7.50	3200	1050	4800	T2	95	59
E53.R11-402T2W	4.00	1.00	125	2.50	7.50	5000	2100	7500	T2	115	110
E53.H59-472T1W	4.70	1.10	45	0.50	1.60	1700	700	2550	T1	55	59
E53.Q59-502T2W	5.00	0.32	100	1.80	9.00	3200	1050	4800	T2	105	59
E53.M59-602T2W	6.00	0.75	70	0.88	2.60	2250	700	3375	T2	75	59
E53.Q59-602T2W	6.00	0.28	100	2.20	11.00	3200	1050	4800	T2	105	59
E53.P59-682T2W	6.80	0.55	80	1.20	6.00	2800	700	4200	T2	95	59
E53.R60-702T2W	7.00	0.25	100	3.00	12.00	3200	1050	4800	T2	115	60
E53.P59-752T2W	7.50	0.50	80	1.50	7.50	2800	700	4200	T2	95	59
E53.H59-802T1W	8.00	1.70	38	0.33	1.00	1400	350	2100	T1	55	59
E53.M59-802T2W	8.00	0.65	80	1.00	3.00	2000	700	3000	T2	75	59
E53.Q59-802T2W	8.00	0.45	100	1.50	7.50	2800	700	4200	T2	105	59
E53.M59-103T2W	10.00	0.52	80	1.10	3.50	1700	700	2550	T2	75	59
E53.P59-103T2W	10.00	0.46	80	1.50	4.50	2250	700	3375	T2	95	59
E53.Q59-103T2W	10.00	0.35	100	1.80	9.00	2800	700	4200	T2	105	59
E53.H59-123T1W	12.00	1.70	40	0.40	1.20	1100	350	1650	T1	55	59
E53.R60-123T2W	12.00	0.29	100	2.20	12.00	2800	700	4200	T2	115	60
E53.P59-143T2W	14.00	0.35	80	1.80	5.50	2000	700	3000	T2	95	59
E53.Q59-143T2W	14.00	0.33	100	2.00	6.00	2250	700	3375	T2	105	59
E53.H59-153T1W	15.00	1.10	40	0.50	1.50	1100	350	1650	T1	55	59
E53.Q59-153T2W	15.00	0.27	100	2.10	6.20	2250	700	3375	T2	105	59
E53.M59-163T2W	16.00	0.85	60	0.65	1.35	1400	350	2100	T2	75	59
E53.P59-163T2W	16.00	0.37	80	1.80	5.50	1700	700	2550	T2	95	59
E53.Q59-183T2W	18.00	0.26	100	2.30	6.90	2000	700	3000	T2	105	59
E53.R60-183T2W	18.00	0.25	100	2.60	10.00	2250	700	3375	T2	115	60
E53.Q59-223T2W	22.00	0.27	100	2.50	7.50	1700	700	2550	T2	105	59
E53.R60-243T2W	24.00	0.21	100	3.00	10.00	2000	700	3000	T2	115	60
E53.M59-253T2W	25.00	0.71	70	0.83	2.50	1100	350	1650	T2	75	59
E53.H59-303T1W	30.00	0.85	60	0.68	2.10	900	350	1350	T1	55	59
E53.N51-303H1W	30.00	1.30	60	1.30	3.90	1600	-	2400	H1	85	51
E53.P59-303T2W	30.00	0.46	80	1.20	3.70	1400	350	2100	T2	95	59
E53.H59-333T1W	33.00	0.95	55	0.68	2.10	700	350	1050	T1	55	59
E53.R60-333T2W	33.00	0.18	100	3.50	10.00	1700	700	2550	T2	115	60
E53.N51-383H1W	37.50	1.20	60	1.40	4.00	1400	-	2100	H1	85	51
E53.N68-403H1W	40.00	1.60	60	1.30	3.90	1600	-	2400	H1	85	68
E53.Q59-403T2W	40.00	0.34	100	1.70	5.10	1400	350	2100	T2	105	59
E53.H59-503T1W	50.00	0.80	60	0.83	2.50	550	280	825	T1	55	59
E53.N51-503H1W	50.00	1.10	70	1.60	4.80	1200	-	1800	H1	85	51
E53.N68-503H1W	50.00	1.50	60	1.40	4.20	1400	-	2100	H1	85	68
E53.P59-503T2W	50.00	0.34	80	1.70	5.00	1100	350	1650	T2	95	59
E53.R60-503T2W	50.00	0.27	100	2.20	10.00	1400	350	2100	T2	115	60

H1



T1/T2



NEW - DC Link Capacitors

The E50 PK16 capacitor can be universally used for the assembly of low inductance DC buffer circuits and DC filters; with its high energy density it can replace banks of series-connected electrolytic capacitors as well as large film capacitors in rectangular cases. The capacitance in a DC buffer circuit must be sufficiently sized to both handle and smoothen the occurring ripple currents. The traditional use of series/parallel-connected electrolytic capacitors offered large capacitance at seeming low cost. However the low cost per microfarad is countered by very low current strength, the high sensitivity to voltage and current surges, as well as high risk of field failures resulting in high maintenance cost. Advanced know-how in special capacitor film coating and many years of practical experience in designing and manufacturing capacitors have allowed the design of the E50 PK16 range with high current density. With fivefold the current strength of conventional electrolytic capacitors, it is not necessary to reproduce the same capacitance in film technology. Instead, the user now gets a superior technical solution within the same – or even less – space offering:

- Superior voltage and current strength
- Dramatic increase in operational life
- Drastic reduction of failures
- Minimisation of power dissipation losses
- Substantial reduction of self-inductance and series resistance
- More exact manufacturing tolerances
- Elimination of sharing resistors

Thanks to its compact cylindrical aluminium (NT) or plastic (N4) can design these capacitors are ideal for both electrical and mechanical requirements of high-speed IGBT converters. Its robust terminals and the robust fixing stud allow for very simple and reliable mounting that unites lowest inductance and highest current strength. The particularly large creepage and clearance distances make this design suitable for a wide range of operating voltages. As a result, existing standard converter concepts can easily be adapted to new applications without having to change the principal construction and to re-approve the entire system. The capacitors listed below have been designed specifically to match the requirements of IXYS UK's press-pack IGBT range in most inverter/converter applications.

Part No.	V_{DC}	Capacitance μF	Series Resistance R_S Ω	Maximum Current I_{MAX} A	Inductance L_E nH	Diameter mm	Length mm	Design
	V							
E50.N15-254N5W	1300	250	4.2	60	40	85	155	N5
E50.N15-304NTW	1300	300	3.7	60	40	85	155	NT
E50.R16-554NTW	1300	545	2.3	80	40	116	165	NT
E50.N25-564NTW	1300	560	2.3	60	60	85	252	NT
E50.R23-824NTW	1300	820	1.7	100	50	116	230	NT
E50.R29-115NTW	1300	1090	1.4	100	60	116	295	NT
E50.R34-145NTW	1300	1370	1.1	100	70	116	345	NT
E50.S29-165NTW	1300	1560	1.1	120	70	136	295	NT
E50.S34-205NTW	1300	1950	0.69	120	70	136	345	NT
E50.N15-603NTW	2800	60	1.3	50	40	85	155	NT
E50.N23-104NTW	2800	100	1.7	60	60	85	232	NT
E50.R16-114NTW	2800	110	0.66	80	40	116	165	NT
E50.R23-174NTW	2800	165	0.63	100	50	116	230	NT
E50.R29-224NTW	2800	220	0.62	100	60	116	295	NT
E50.R34-284NTW	2800	275	0.85	100	70	116	345	NT
E50.S29-314NTW	2800	310	0.61	120	70	136	295	NT
E50.S34-394NTW	2800	390	0.76	120	70	136	345	NT
E50.N15-293NTW	3600	29	1.4	50	40	85	155	NT
E50.N23-503NTW	3600	50	1.9	60	60	85	232	NT
E50.R16-573NTW	3600	57	0.67	80	40	116	165	NT
E50.R23-863NTW	3600	85.5	0.65	100	50	116	230	NT
E50.R29-114NTW	3600	114	0.68	100	60	116	295	NT
E50.R34-144NTW	3600	142	0.88	100	70	116	345	NT
E50.S29-164NTW	3600	160	0.63	120	70	136	295	NT

Other voltage/capacitor ratings are available on request. Please contact IXYS UK for more information



Power Semiconductor Chips

IXYS offers a wide range of power semiconductor dies for a multitude of applications.

Bipolar Chips	V_{RRM} / V_{DRM} V	$I_{F(AV)M} / I_{T(AV)M}$ A	t_{rr} ns
Schottky Diodes	8 - 200	5 - 300	-
HiPerFRED™ (Low Leakage)	200 - 1200	10 - 150	30 - 40
Sonic™ Fast Recovery Diodes	600 - 1800	5 - 150	30 - 60
FRED™ (Low Forward Voltage Drop)	200 - 1200	10 - 150	40 - 60
Semi-Fast Diodes	1200 - 1600	15 - 60	60 - 100
Rectifier Diodes	1200 - 2200	10 - 400	-
Phase Control Thyristors	800 - 2200	5 - 300	-
IGBT Chips	V_{CES} V	I_C A	Speed
XPT IGBT	650	6 - 300	medium / fast
XPT IGBT	900	20 - 300	fast
XPT IGBT	1200	3 - 200	medium
XPT IGBT	1700	75 - 200	medium
HV XPT IGBT	3300 / 4500	40 - 60	medium

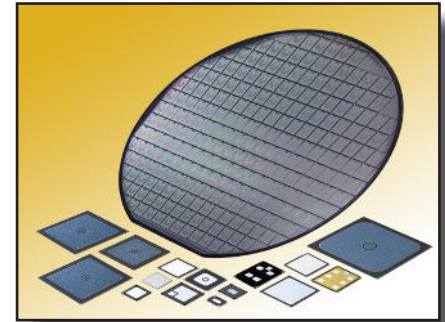

Mode of Shipment:

- in wafer form, unsawn, electrically tested, rejects are inked
- sawn wafer on foil, electrically tested, rejects are inked
- known good die in tray (Waffle Pack)
- customized die sizes / geometry on request

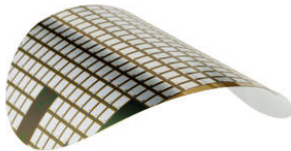

XPT Features:

- thin wafer technology
- low $V_{ce(sat)}$ and E_{off}
- very low gate charge
- rugged, square RBSOA @ $3 \times I_{nom}$
- short circuit rated (10 μ s)
- easy to parallel

For chip sales please contact:
chipsales@ixys.de

Direct Copper Bonded Ceramic Substrates

DCB Ceramic Substrates (Al₂O₃)

IXYS manufactures Direct Copper Bonded substrates on aluminum oxide (Al₂O₃) base. DCB ceramic substrates form the basis for new product ideas and electronic developments with a high degree of integration.

- carriers for semiconductor chips and connection clips
- circuits similar to that on a PC board
- electrical isolator for separating „current paths“ from „heat paths“
- transfer medium for heat dissipation from active parts into heat sink

Standard bonded DCB panel dimensions are:

Unclad aluminum oxide ceramic			
Al ₂ O ₃ content		> 96	%
dimensions		138x210, 138x190.5, 115x165*	mm
usable area	max.	130x200, 130x180, 107x156*	mm
thickness		1.00, 0.63, 0.38, 0.25	mm
arc through voltage		10	kV
thermal conductivity		> 24	W/m · K
Conduction layers - both sides			
copper thickness		0.3 (< 0.3 on request)	mm
conductor width	min.	0.3 +/- 0.2	mm
conductor spacing	min.	0.4 +/- 0.2	mm
spacing conductor/edge of ceramic	min.	0.35 +/- 0.2	mm
surface finishes available		bare copper; nickel plated; nickel + gold plated	
peel-off resistance (90° peel test)		>6	N/mm
DCB ceramic substrate			
application temperature range		-55...+850	°C
resistant to hydrogen	max.	400	°C
thermal expansion coefficient	to typ.	7.4 x 10-6	K ⁻¹

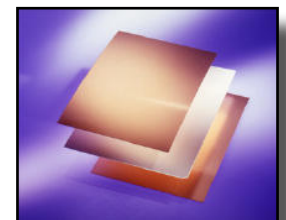

- DCB parts are available as:
- bonded plate
 - bonded and patterned plate
 - prelasered, unbroken plate
 - individuale substrates
 - customer specific substrates on request

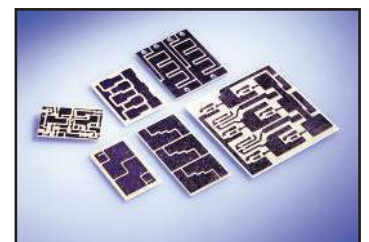

* = (for 0.25 mm thk.)

Application Notes Highlights

further information and downloads see www.ixys.com

Power Factor Correction	
IXAN0001	3-Phase PFC using Vienna Rectifier Approach and Modular Construction for Improved Overall Performance, Efficiency and Reliability
IXAN0002	Single and Three-Phase Rectifiers with Active Power Factor Correction for Enhanced Mains Power Quality
IXAN0003	Rectifiers with Power Factor Correction
IXAN0004	Design and Experimental Investigation of a Three-Phase, High Power Density, High Efficiency, Unity Power Factor PWM (VIENNA) Rectifier Employing a Novel Integrated Power Semiconductor Module
IXAN0005	Status of the Techniques of Three-Phase Rectifier Systems with Low Effects on the Mains
MOSFETs and IGBTs Drivers	
IXAN0012	MOSFET/IGBT Drivers - Theory and Applications
IXAN0011	Driving Your MOSFETs Wild to Obtain Greater Efficiencies, Power Densities and Lower Overall Cost
BiMOSFETs Applications	
IXAN0013	Capacitor Charge/Discharge Circuits, utilizing High Voltage IGBTs and ZCS Resonant Mode Techniques
IXAN0014	Comparative Performance of BiMOSFETs in Fly-back Converter Circuits
IXAN0015	Use of BiMOSFETs in Modern Radar Transmitters
IXAN0016	IXBH40N160 BiMOSFET Developed for High Voltage and High Frequency Applications
IXAN0017	New 1600V BiMOSFET Transistors Open Up New Applications
Automotive Applications	
IXAN0018	A High Current Dual Inline Packaged Trench MOSFET Three Phase Full Bridge as Contribution to Automotive System Integration
IXAN0019	High Power TrenchMOSFETs Solutions in Automotive Designs
IXAN0020	Power Electronic Supply for Automotive Starter Generator
IXAN0021	New Trench Power MOSFETs in Isolated Packages
Isolation Techniques, Mounting, Soldering and Cooling	
IXAN0071	The SMPD Package and its Mounting Instructions
IXAN0022	Capitalizing on the Advantages of ISOPLUS Products
IXAN0023	General Mounting Instructions
IXAN0025	ISOPLUS-The Revolution in Discrete Isolation Technique
IXAN0026	Combining the Features of Modules and Discretes in a New Power Semiconductor Packages
IXAN0028	The Revolution in Discrete Isolation Technique
IXAN0030	Surface Mount Soldering Recommendations for TO-263 and TO-268 case styles
IXAN0031	New ISOPLU247 Power Package Features 2500V Internal Isolation Revolutionary Approach Improves Thermal Conductance and Reliability
Power Modules	
IXAN0034	Recommended Use of the Integrated NTC Thermistor Temperature Sensor in IXYS Power Modules
IXAN0035	Mounting Instructions for _A7, _E7, _A8 and _E8 Module Series
IXAN0036	Investigations on Electromagnetic Compatibility of Power Semiconductor Modules Integrated in a Module
IXAN0037	Power Cycle Capability of solder contact DCB-Modules
FREDs and Schottky Diodes	
IXAN0042	Is the Lowest Forward Voltage Drop Schottky Diode Always the Best Choice?
IXAN0043	Input Rectifiers with Semifast Diodes for DC link.
IXAN0044	Characteristics and Applications of Fast Recovery Epitaxial Diodes.
IXAN0060	Optimized Ultra Fast Diodes for Switching Applications
Power MOSFETs	
IXAN0057	Series Operation of MOSFET and IGBT Switches
IXAN0061	Power MOSFET Basics
IXAN0062	IXYS Power MOSFET Products
IXAN0063	Application note on Depletion-mode
IXAN0064	IXYS P-Channel MOSFET
IXAN0065	IXYS Power MOSFET Datasheet Parameters Definition
IXAN0068	Linear Power MOSFETS Basic and Application
IXAN0069	Synchronous DC to DC Converter Design
IGBTs	
IXAN0063	IGBTs
IXAN0070	Drive with the IXYS XPT IGBT
IXAN0072	Discrete 600V GenX3 XPT IGBTs

Outline drawings

Dimensions in mm and inches (1 mm = 0.0394")

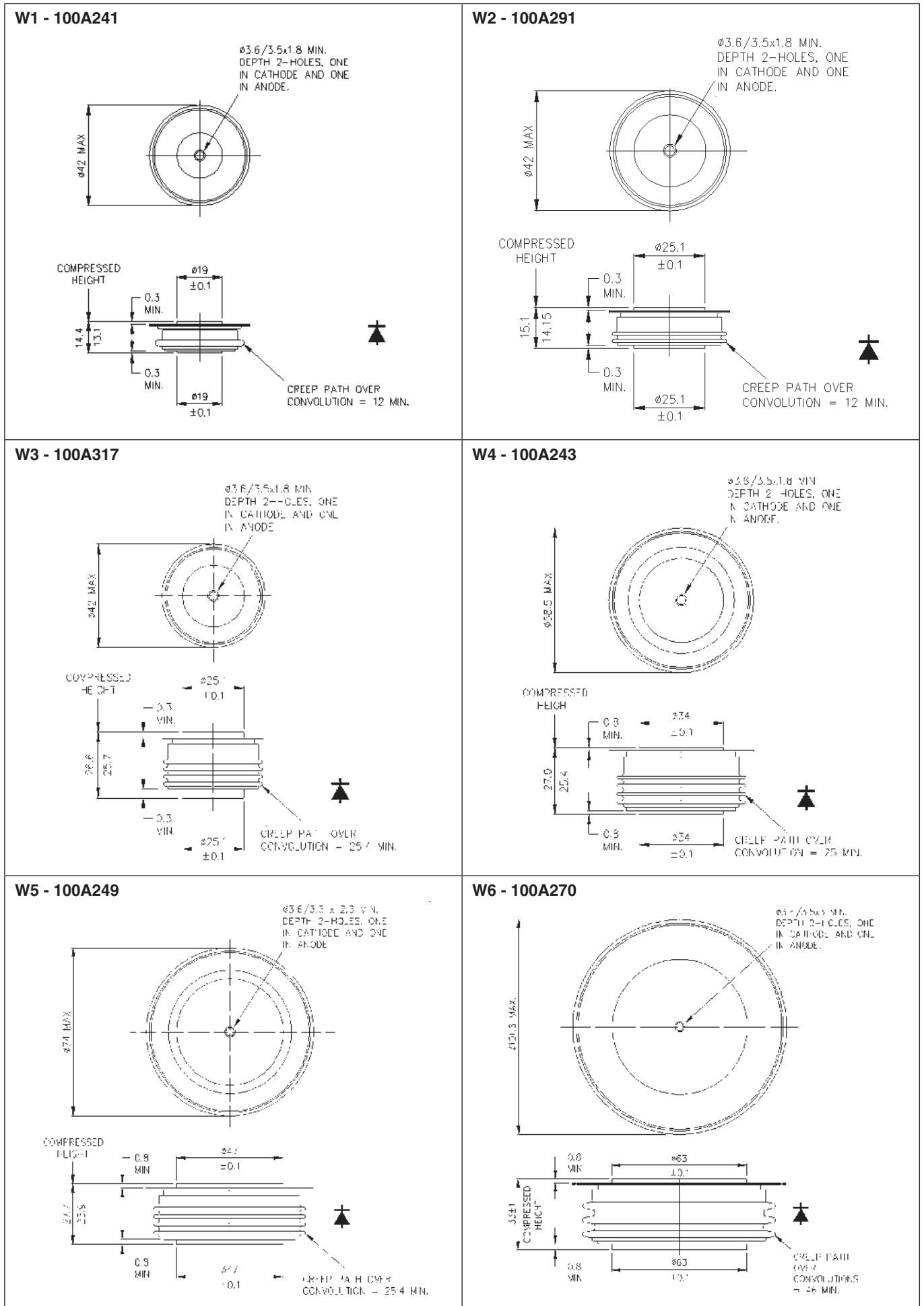

Outline drawings

Dimensions in mm and inches (1 mm = 0.0394")

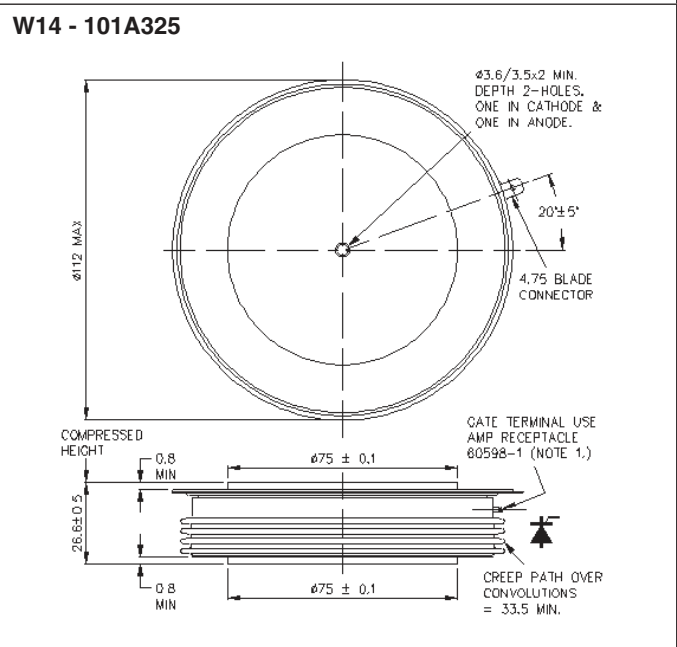
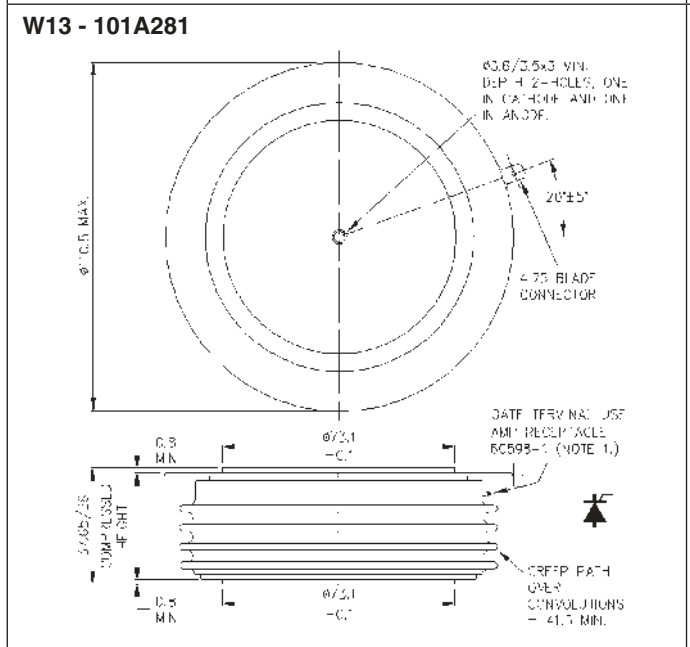
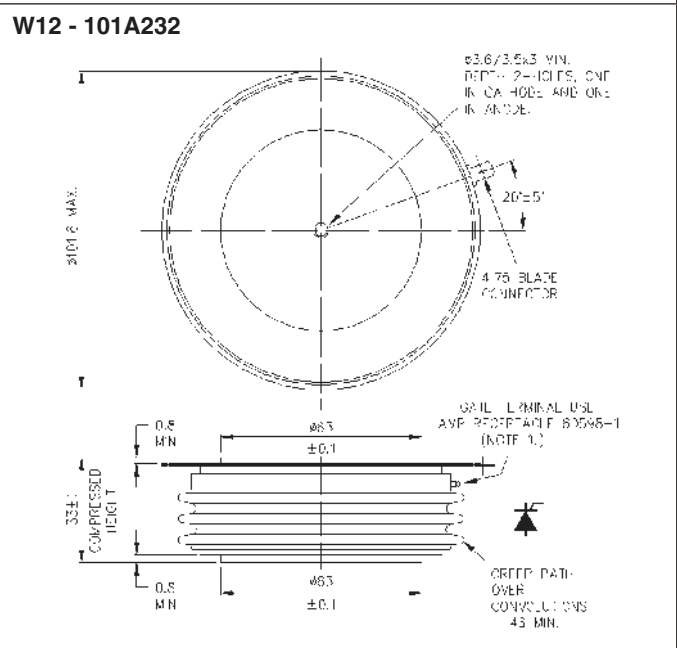
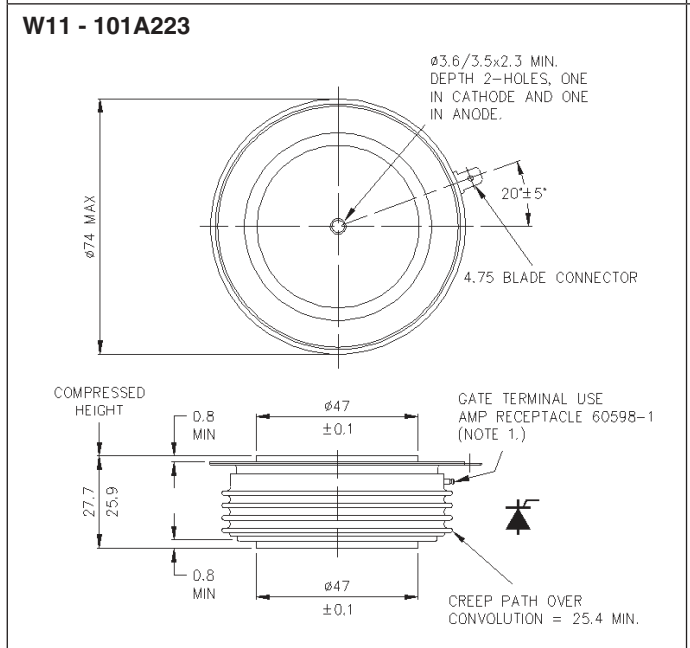
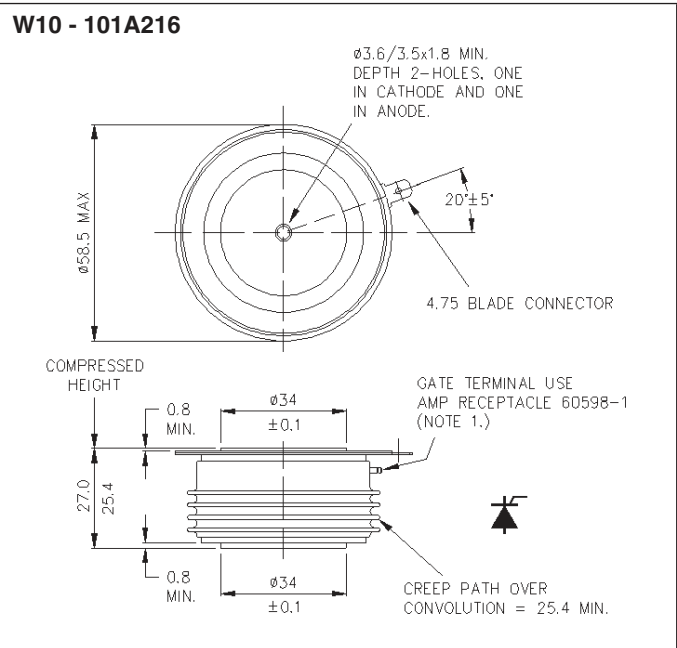
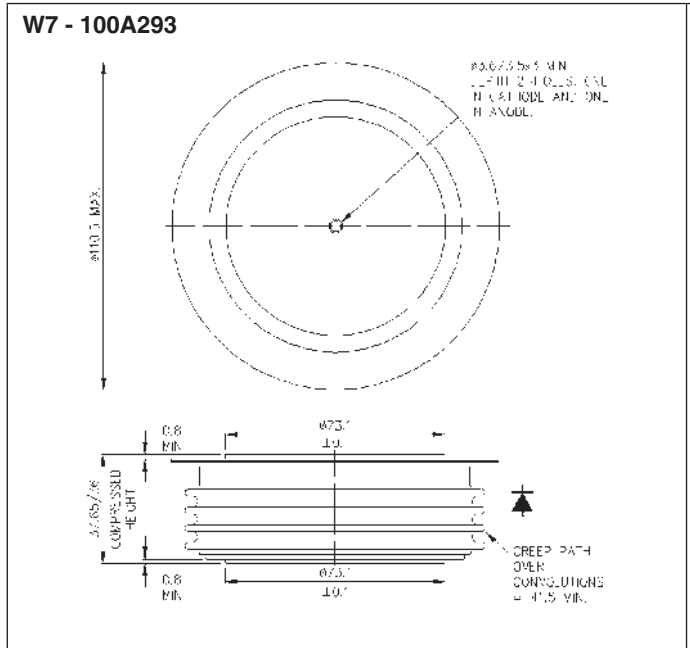

Dimensions in mm and inches (1 mm = 0.0394")

W15 - 101A322

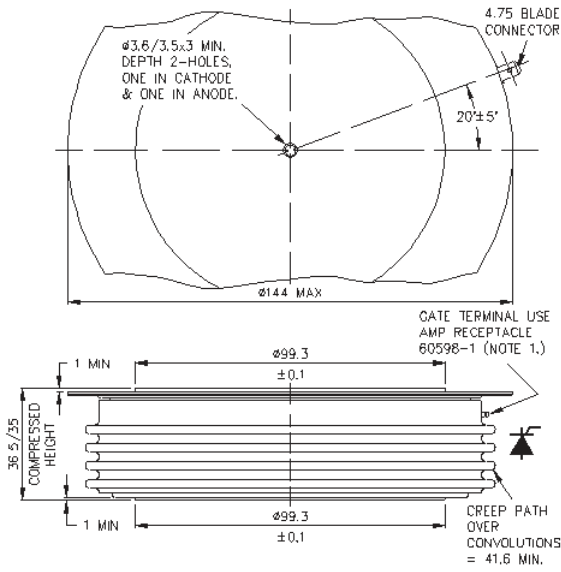

W16 - 101A235

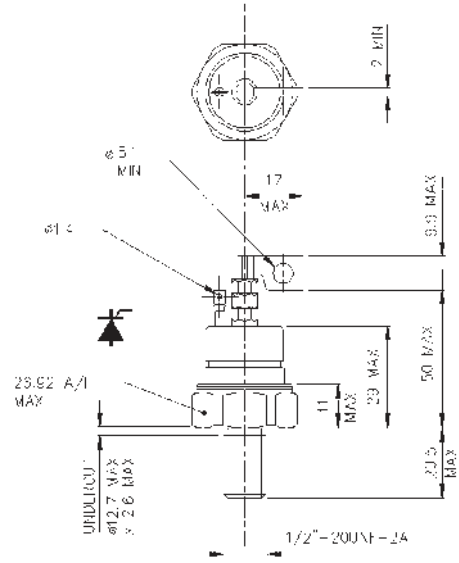

W17 - 101A231

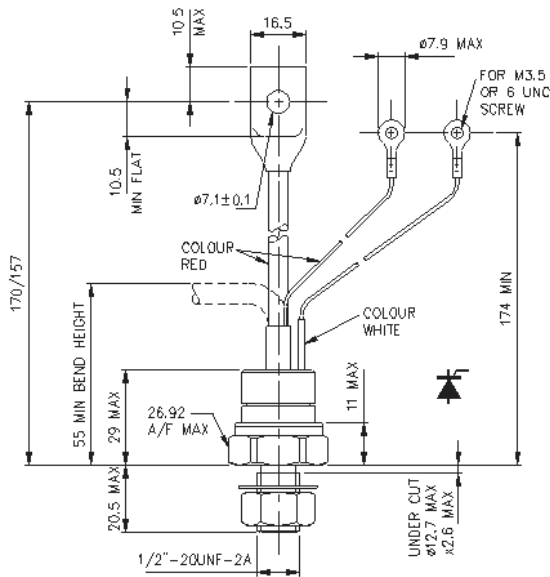

W18 - 101A225

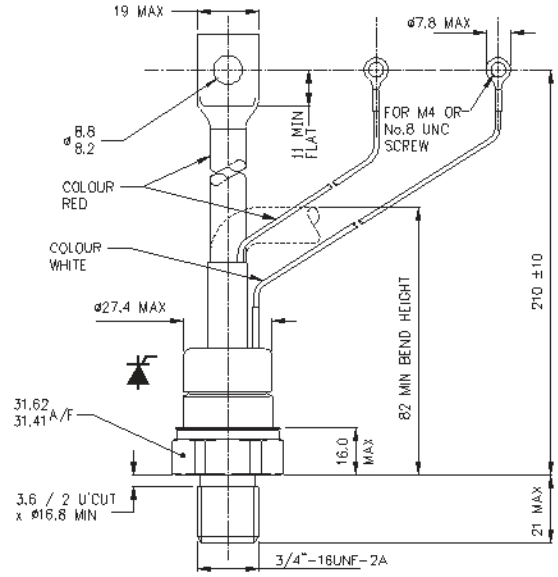

W20 - 100A303

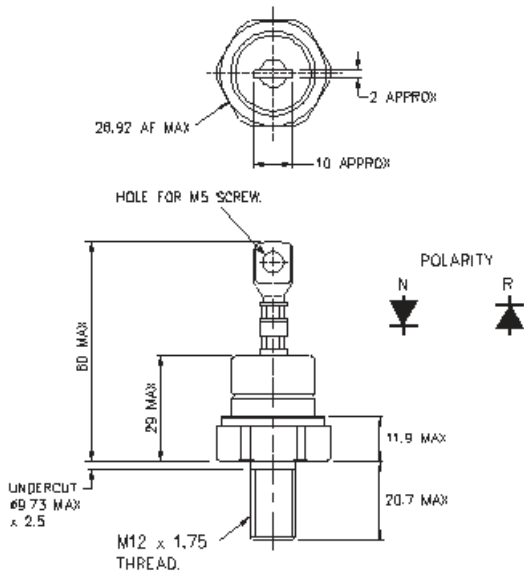

W21 - 100A294

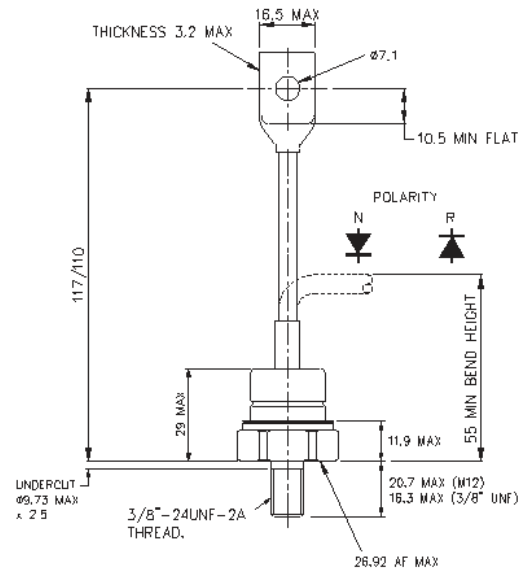

Dimensions in mm and inches (1 mm = 0.0394")

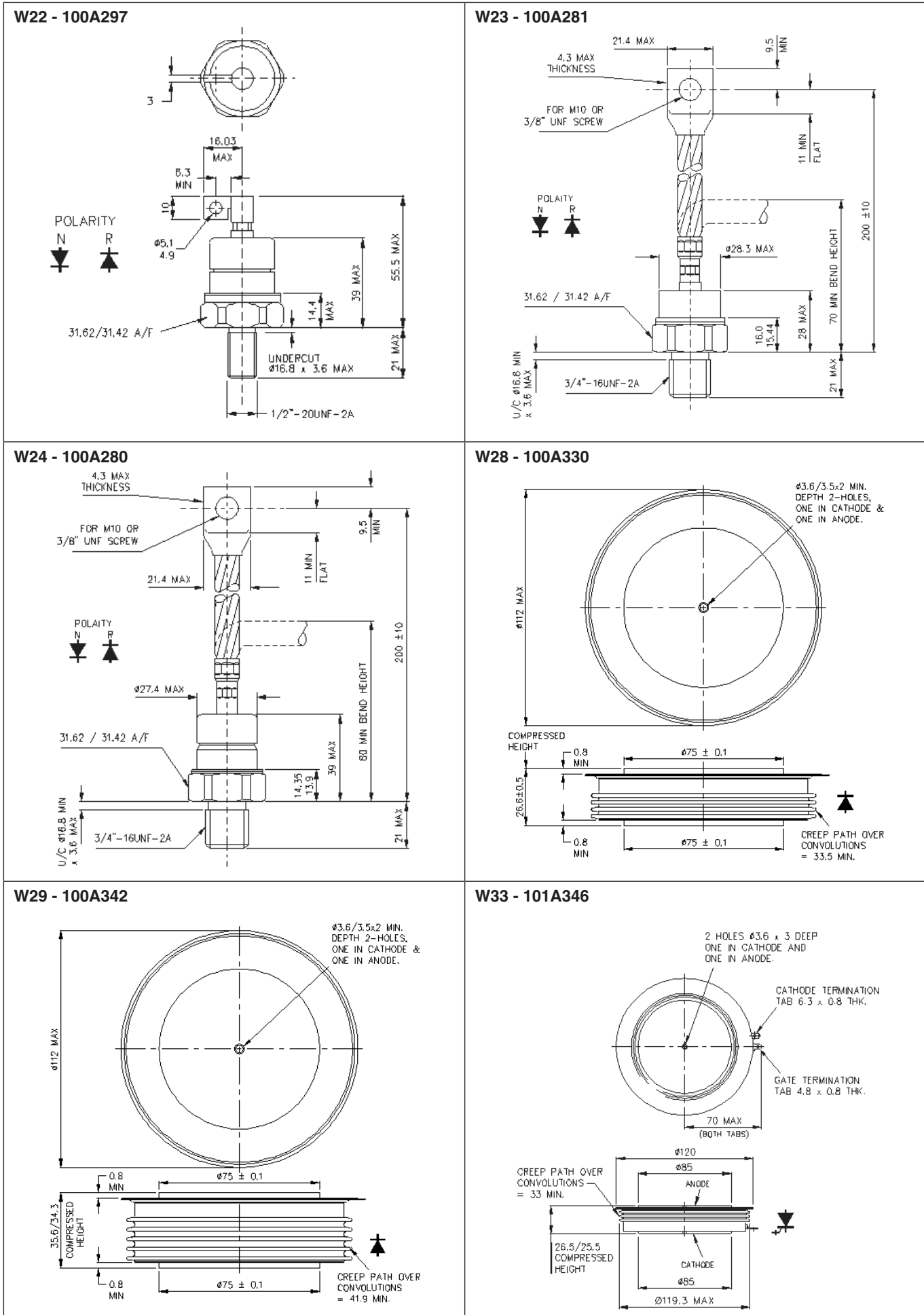

Dimensions in mm and inches (1 mm = 0.0394")

W34 - 101A287

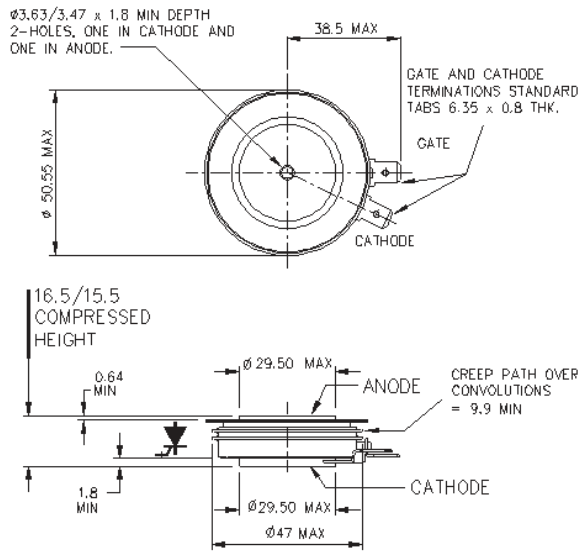

W35 - 101A358

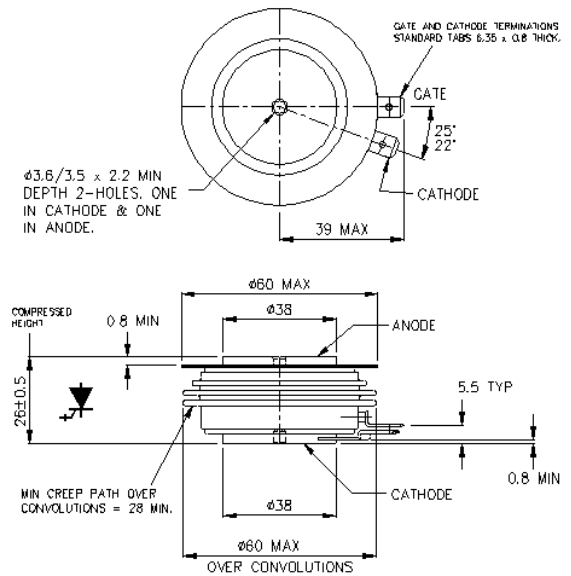

W36 - 101A288

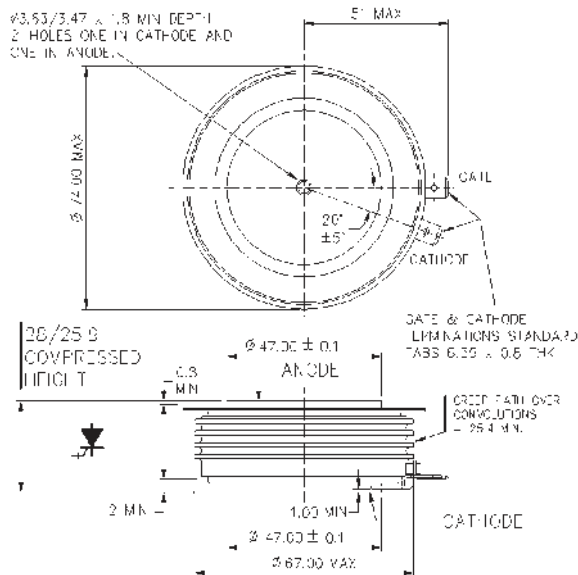

W37 - 100A325

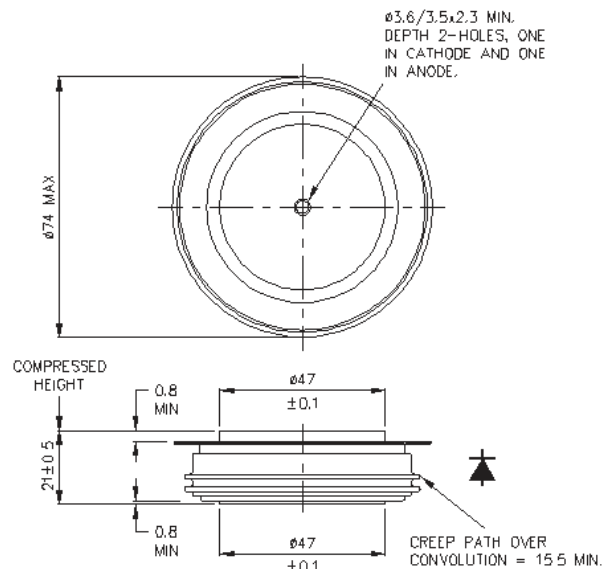

W39 - 100A338

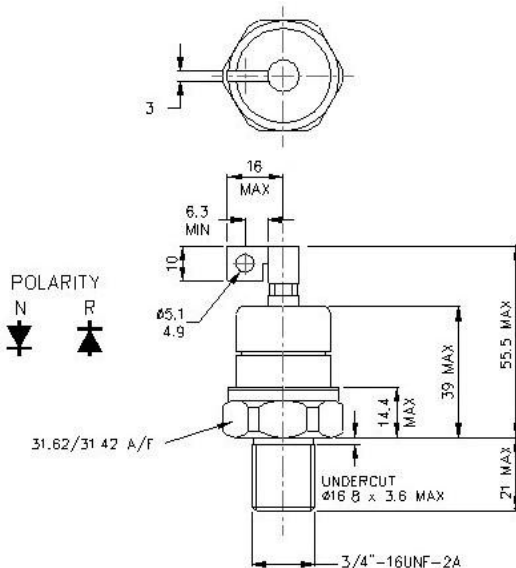

W40 - 171A107

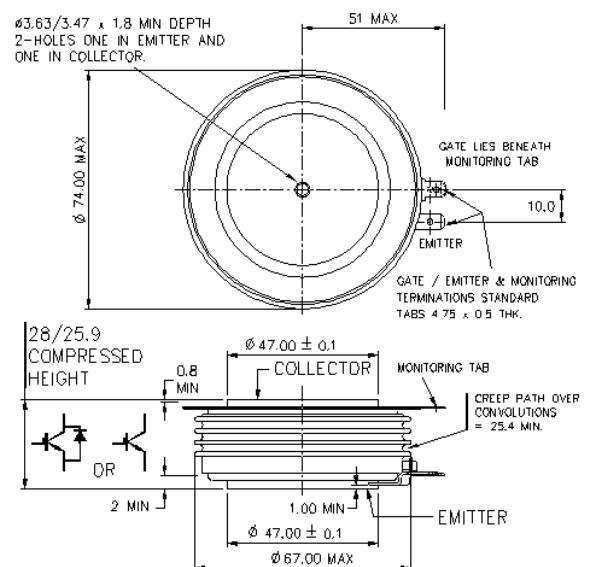

Dimensions in mm and inches (1 mm = 0.0394")

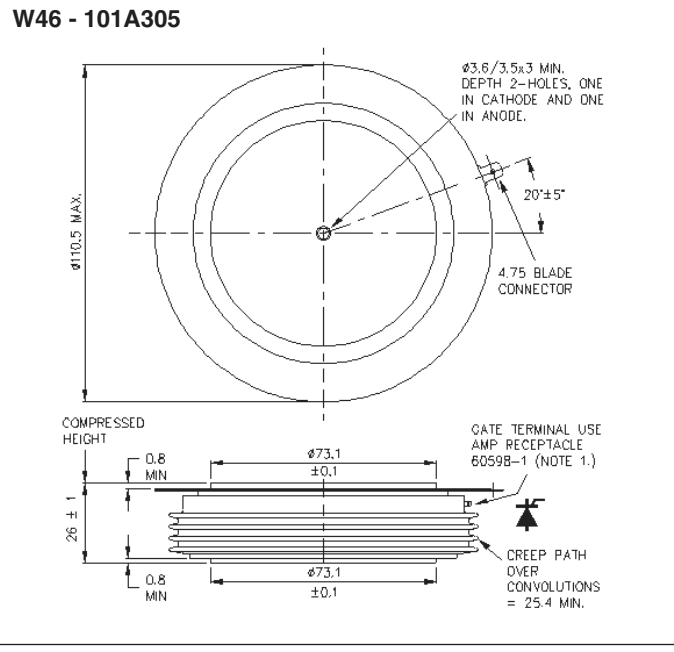
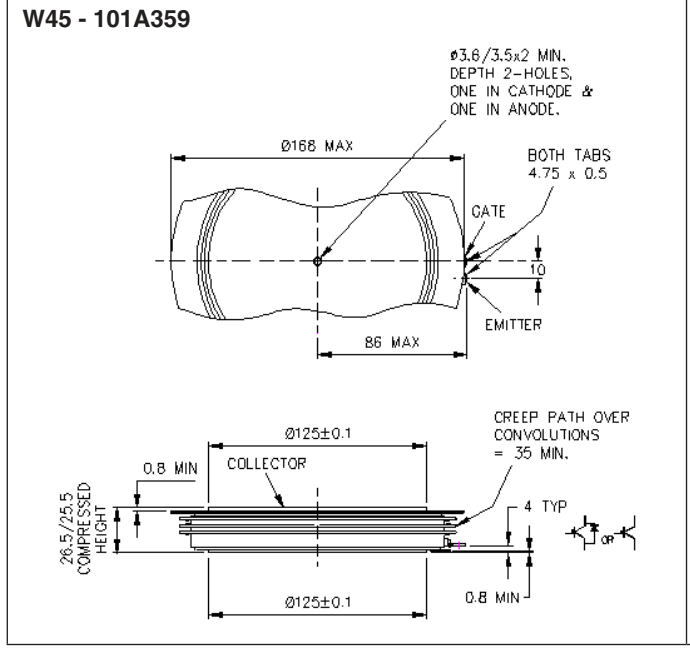
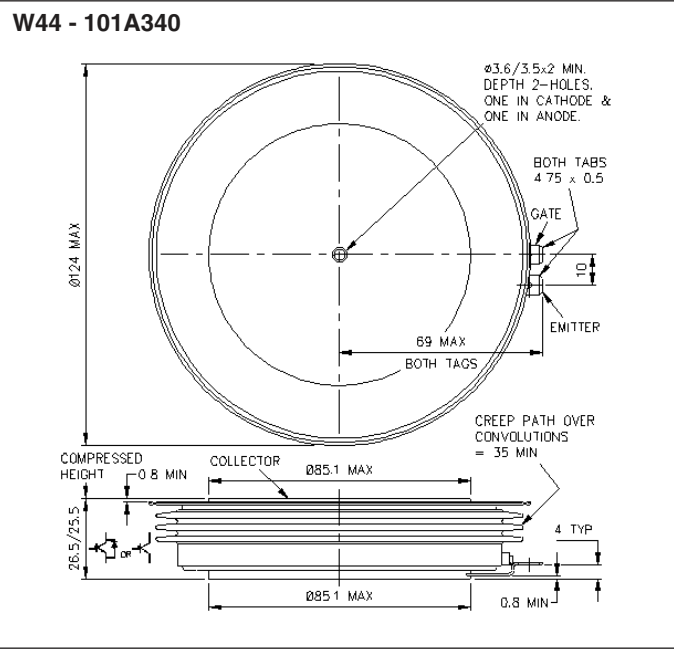
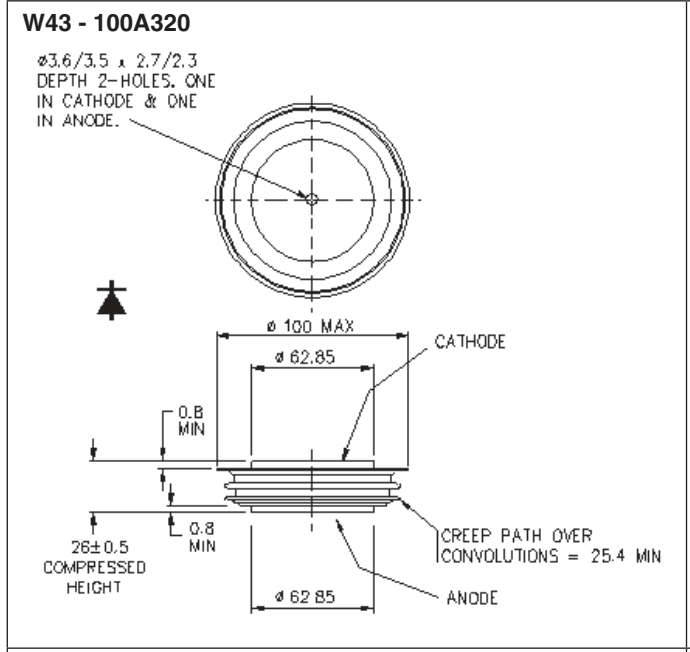
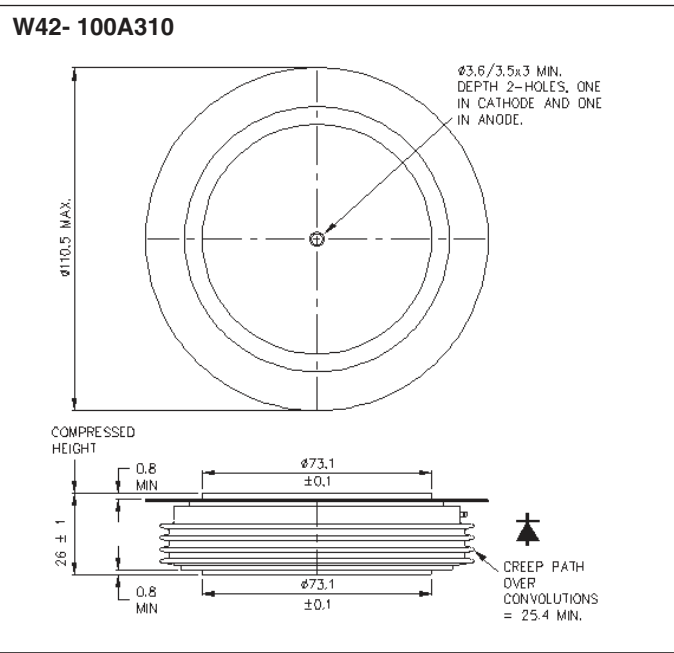
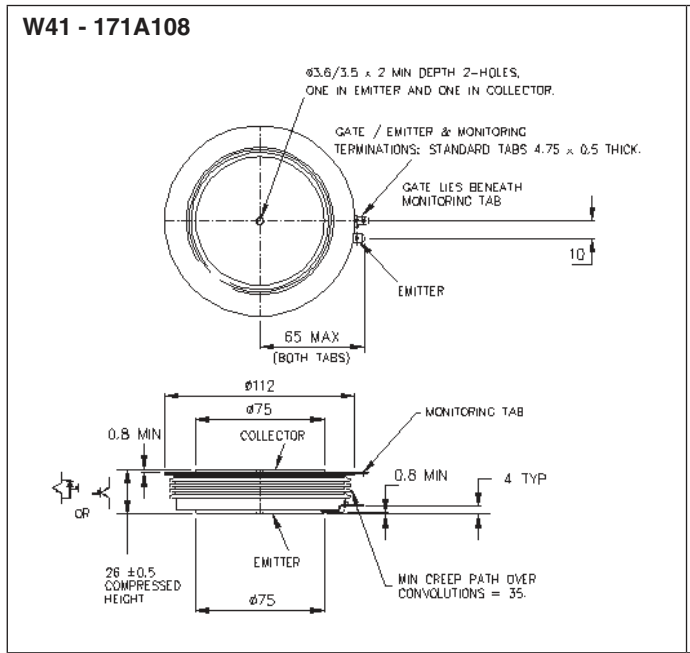

Dimensions in mm and inches (1 mm = 0.0394")

<p>W46x</p> <p>WC46*</p> <p>Device outline W46 is available with a slightly reduced height of 25 mm.</p> <p>At the time of going to press, this option only applies to two Phase Control Thyristors: N3880ZD160-180 and N6012ZD020-060.</p> <p>Please refer to Chippenham Factory.</p>	<p>W47 - 100A322</p> <p>Technical drawing showing top and side views of the W47 - 100A322 thyristor. The top view shows a circular component with an outer diameter of 74 MAX and two holes of diameter 3.6/3.5 x 2.3 MIN. The side view shows a compressed height of 14 ± 0.5, a diameter of 47 ± 0.1, and 0.8 MIN gaps between the layers. The creep path over convolution is 17 MIN.</p>
<p>W48 - 101A347</p> <p>Technical drawing showing top and side views of the W48 - 101A347 thyristor. The top view shows a circular component with an outer diameter of 150 MAX, two holes of diameter 2.7/2.3 x 3 MIN, a 4.75 BLADE CONNECTOR, and a 20° ± 5° angle. The side view shows a compressed height of 26 ± 0.5, a diameter of 100 ± 0.1, 0.4 MIN gaps, a 1 MIN base, and a creep path over convolution of 36 MIN.</p>	<p>W49 100A354</p> <p>Technical drawing showing top and side views of the W49 100A354 thyristor. The top view shows a circular component with an outer diameter of 62 MAX and two center holes of diameter 3.5 x 1.5 DEEP. The side view shows a compressed height of 8 ± 0.25, a diameter of 44.40 ± 0.1, a diameter of 58 MAX, and a creep distance over ceramic of 4mm.</p>
<p>W51 - 101A334</p> <p>Technical drawing showing top and side views of the W51 - 101A334 thyristor. The top view shows a circular component with an outer diameter of 112 MAX, two holes of diameter 3.6/3.5 x 2 MIN, a 4.75 BLADE CONNECTOR, and a 20° ± 5° angle. The side view shows a compressed height of 35 ± 0.5, a diameter of 75 ± 0.1, 0.8 MIN gaps, and a creep path over convolution of 41.9 MIN.</p>	<p>W52 - 100A328</p> <p>Technical drawing showing top and side views of the W52 - 100A328 thyristor. The top view shows a circular component with an outer diameter of 144 MAX and two holes of diameter 3.6/3.5 x 3 MIN. The side view shows a compressed height of 36.5/35, a diameter of 99.3 ± 0.1, 1 MIN gaps, and a creep path over convolution of 41.6 MIN.</p>

Dimensions in mm and inches (1 mm = 0.0394")

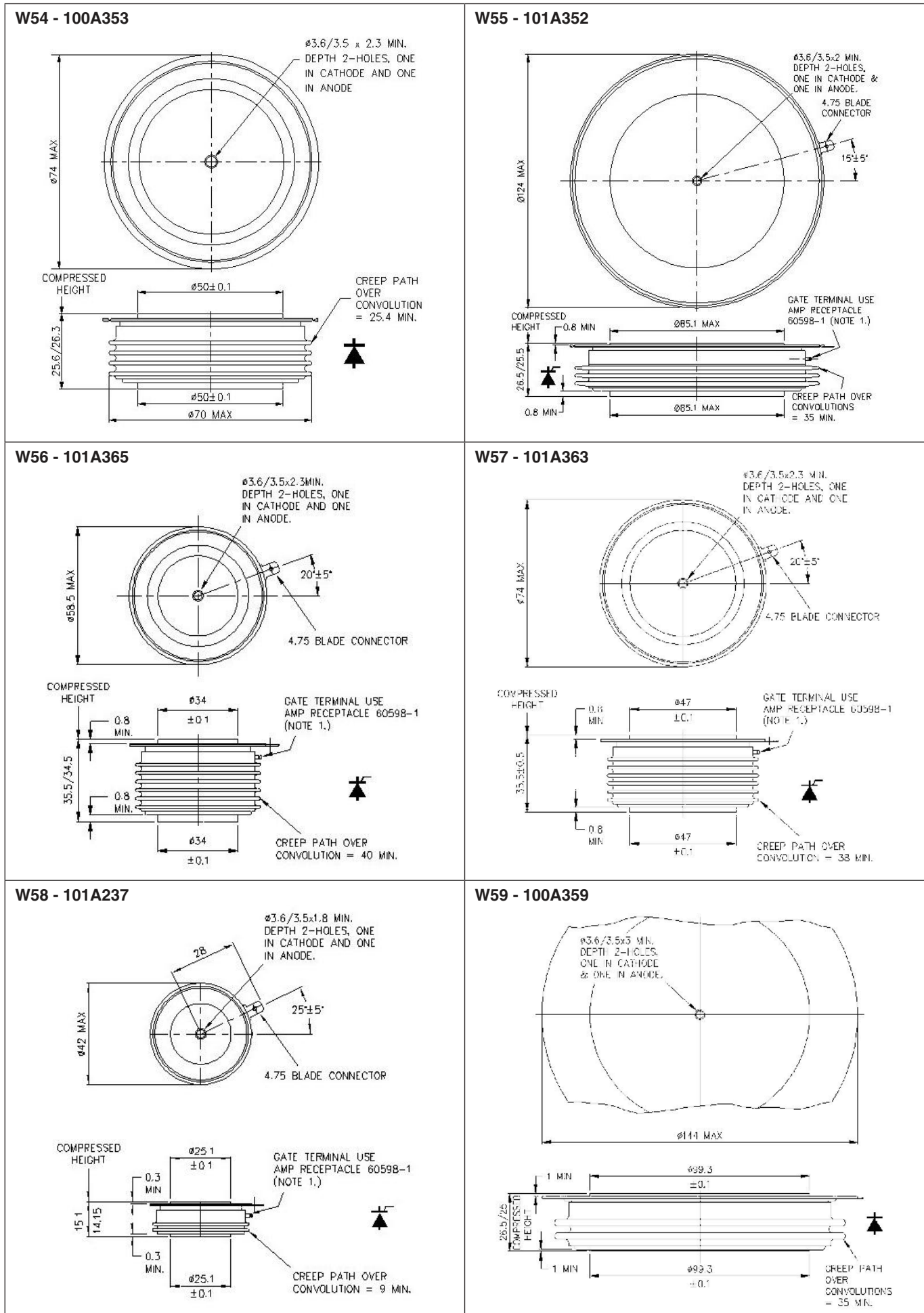

Outline drawings

Dimensions in mm and inches (1 mm = 0.0394")

W62 - 101A314

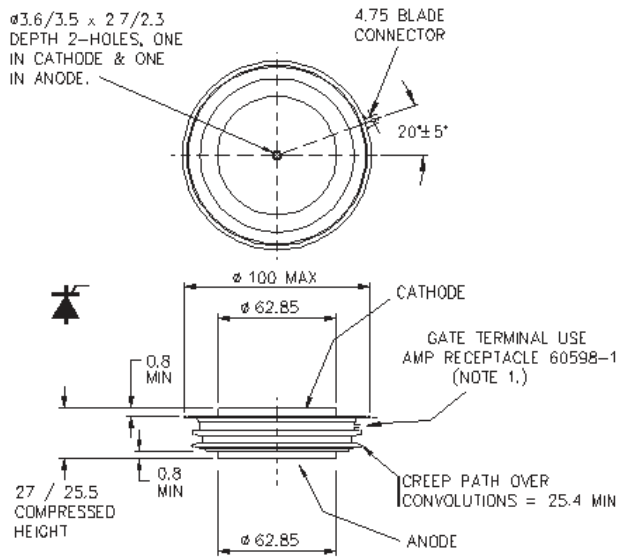

W63 - 150A111

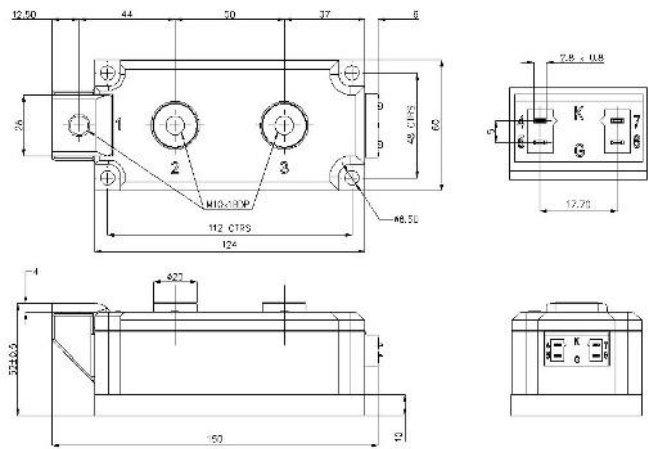

W64 - 150A113

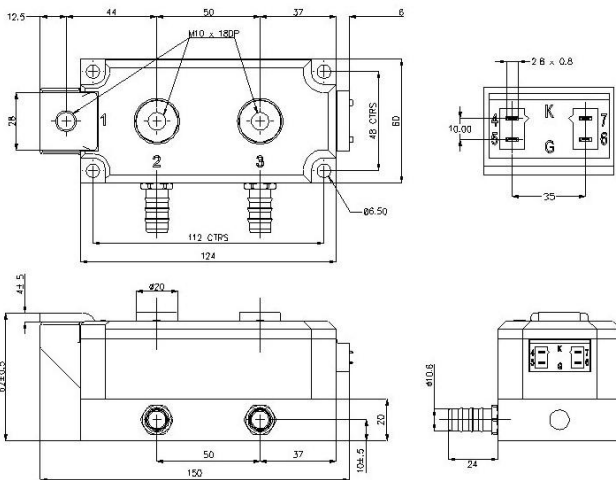

W67 - 101A366

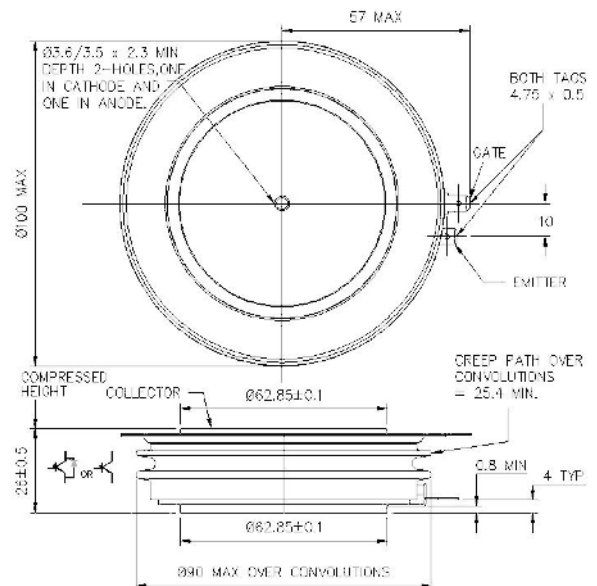

W68 - 100A367

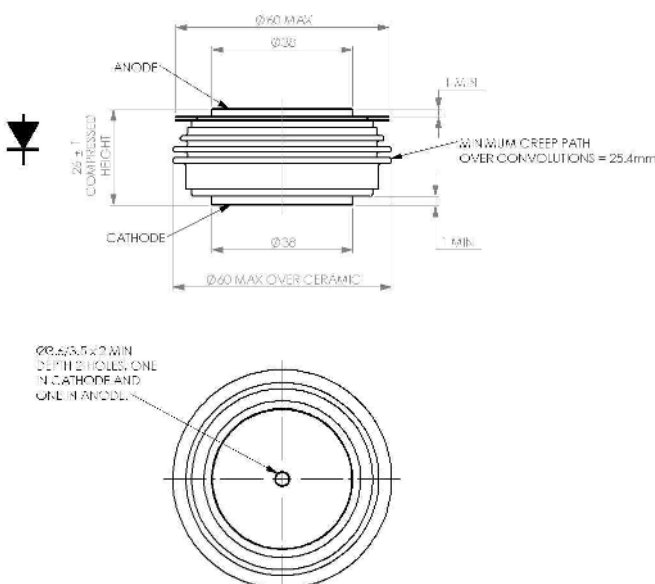

W70 - 101A357

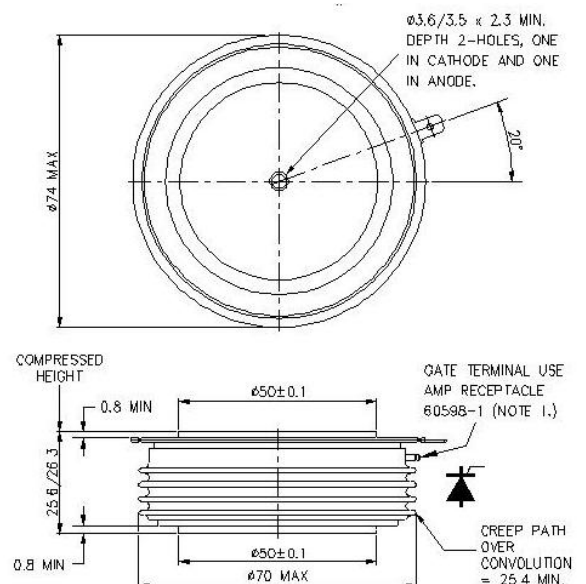

Dimensions in mm and inches (1 mm = 0.0394")

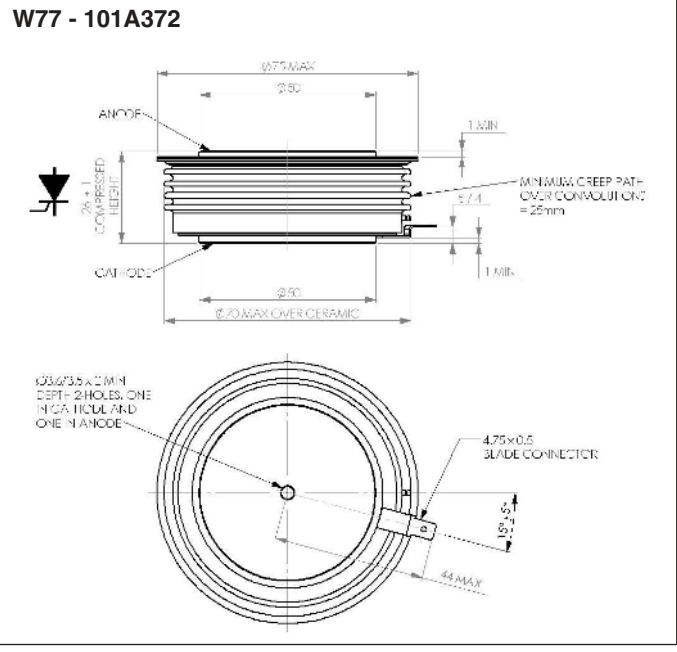
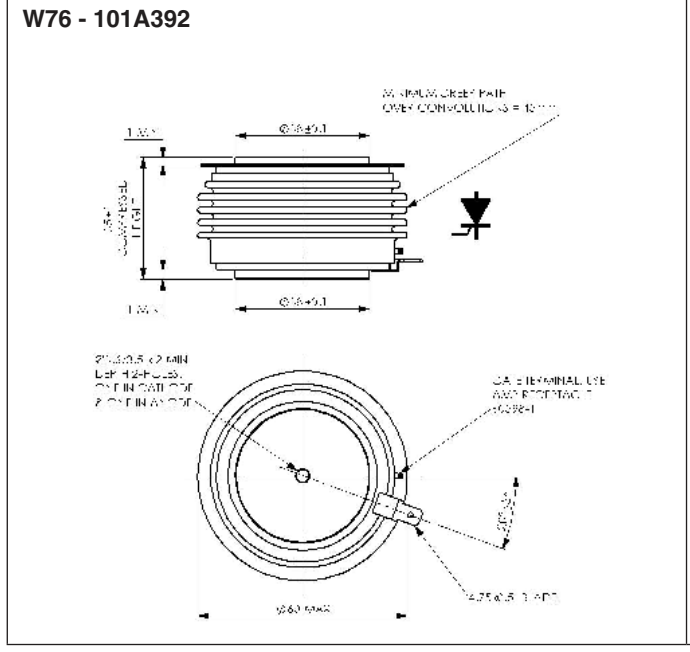
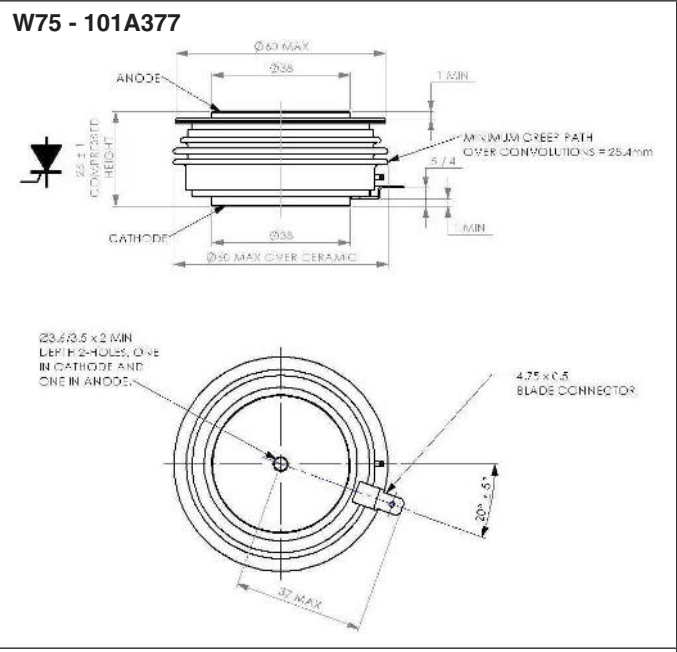
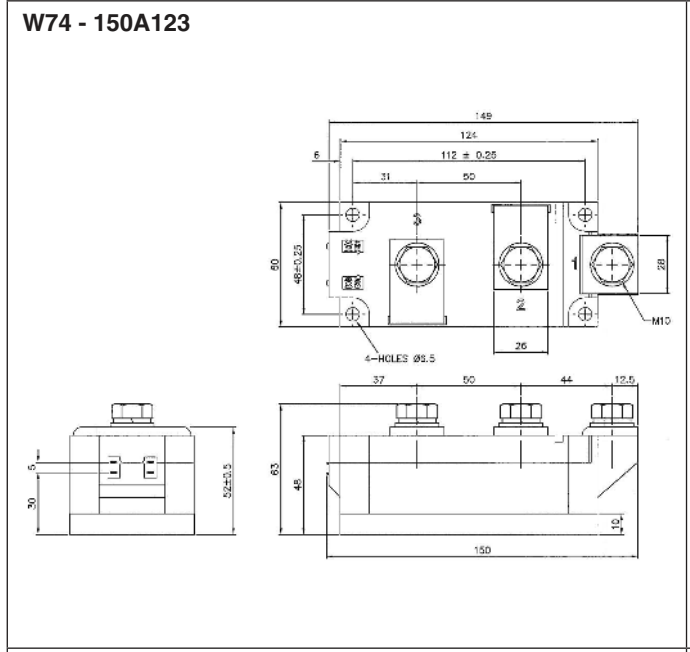
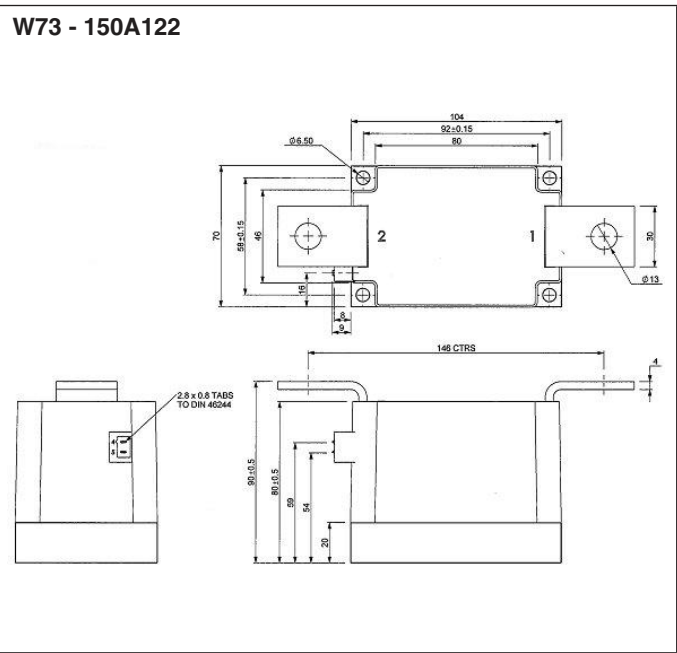
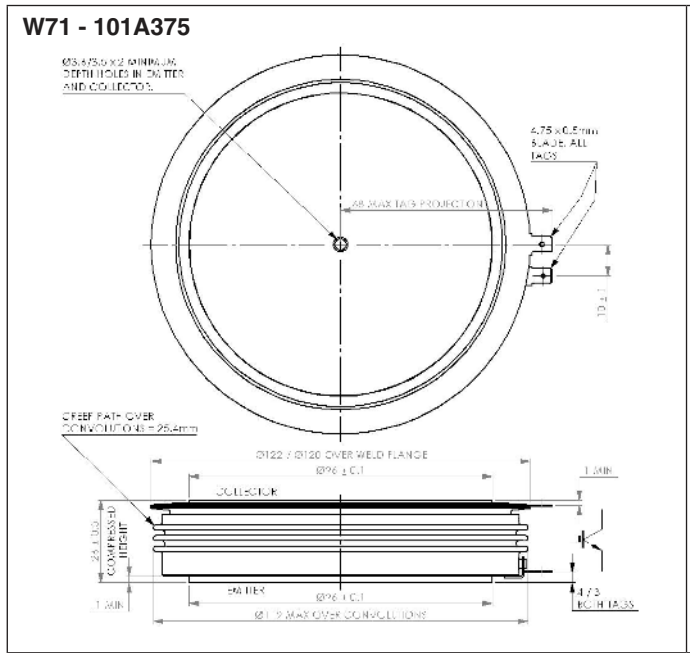

Outline drawings

Dimensions in mm and inches (1 mm = 0.0394")

W78 - 101A393

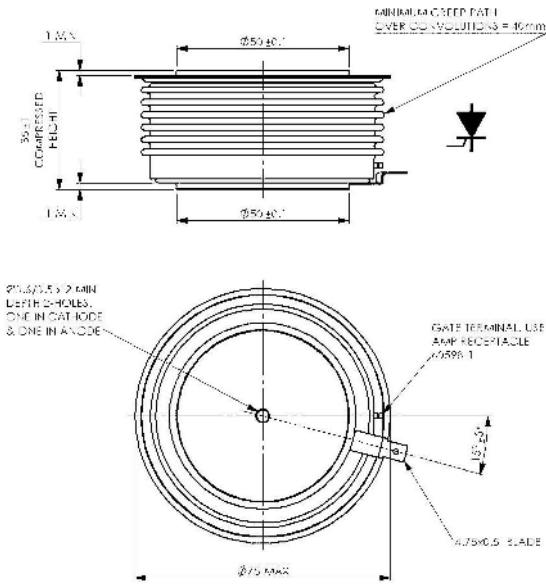

W81 - 101A373

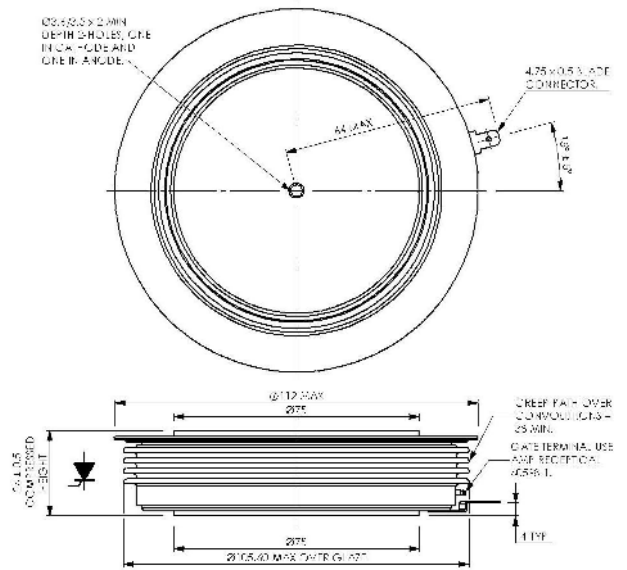

W82 - 101A395

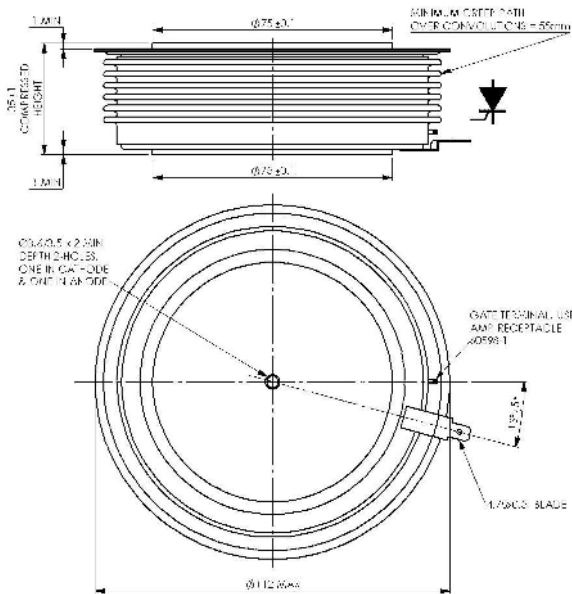

W85 - 101A388

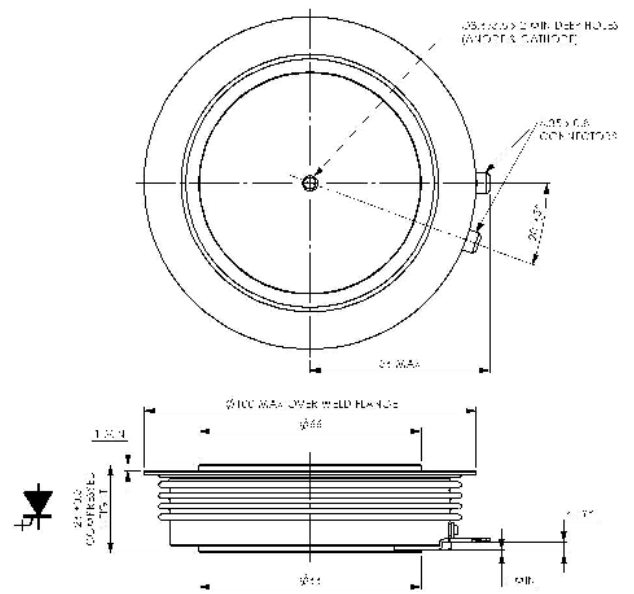

W86 - 101A316

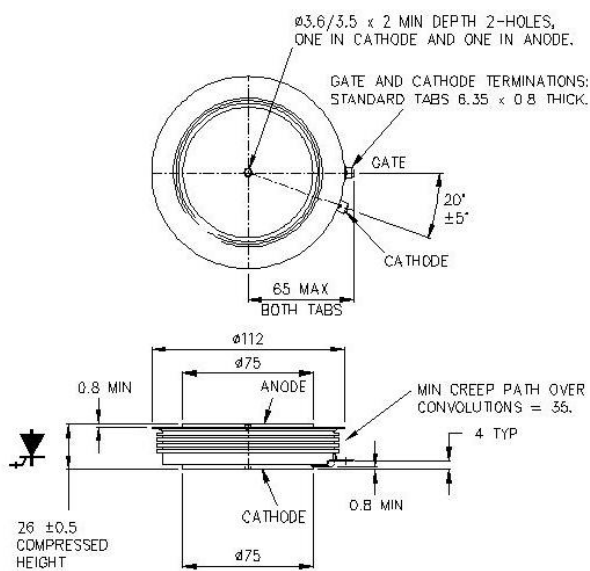

W87 101A376

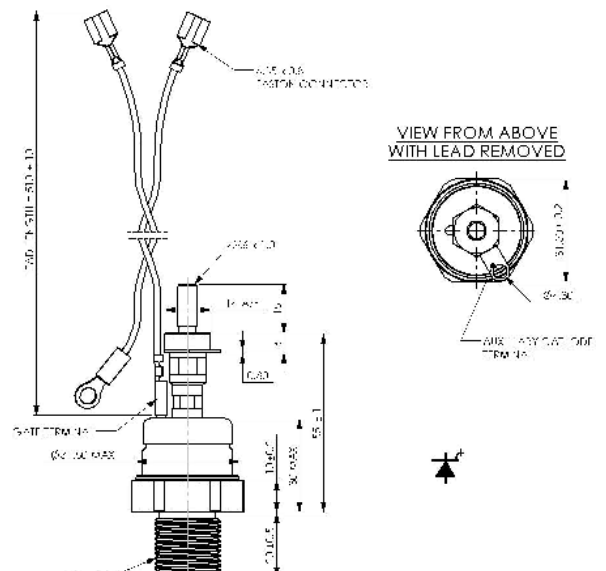

Outline drawings

Dimensions in mm and inches (1 mm = 0.0394")

W94 - 100A372

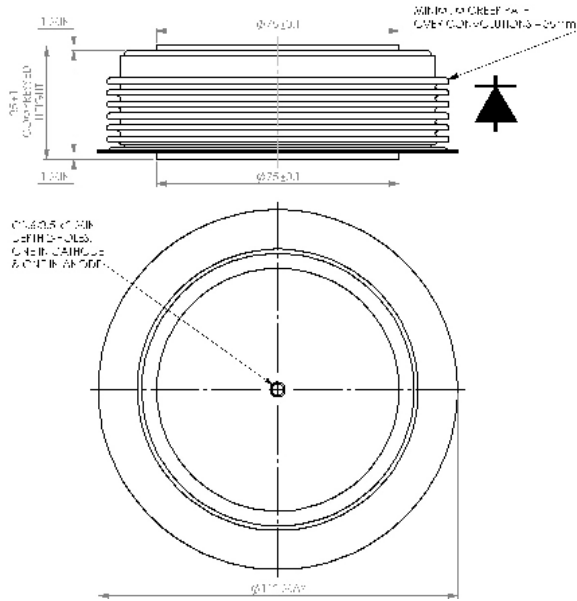

W95 - 101A403

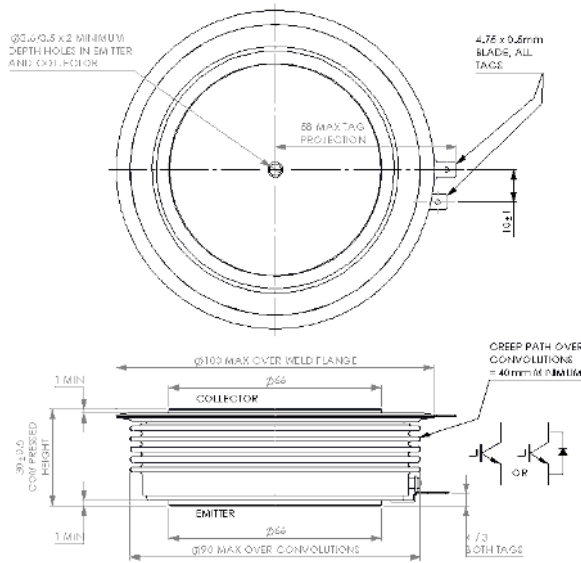

W96 - 101A409

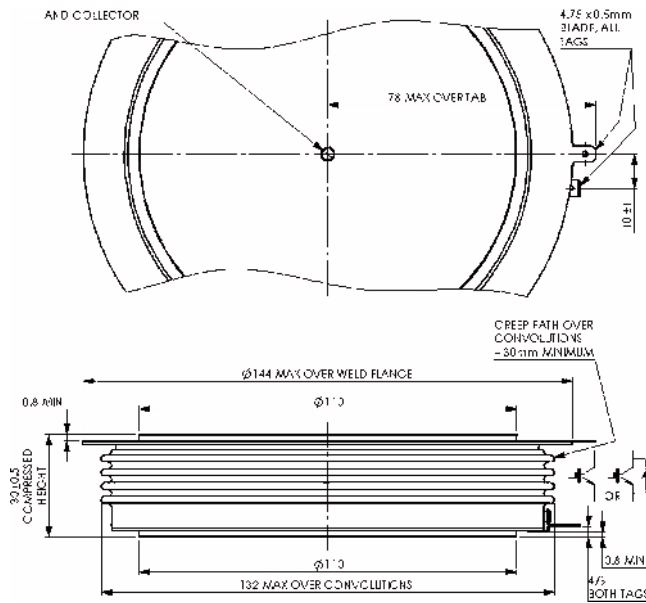

W97 - 100A379

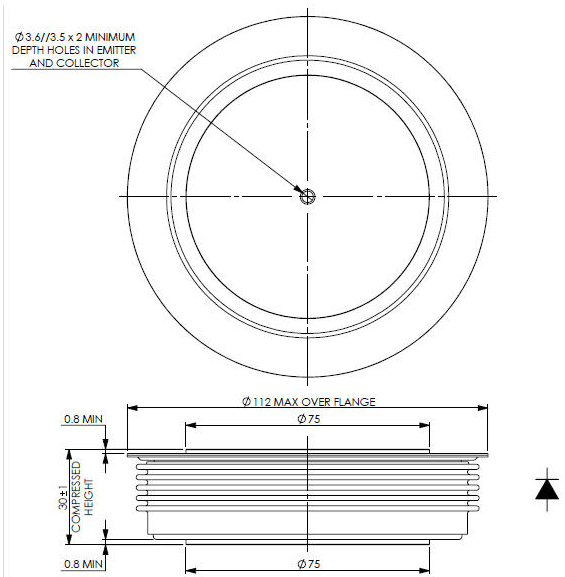

W98 - 101A413

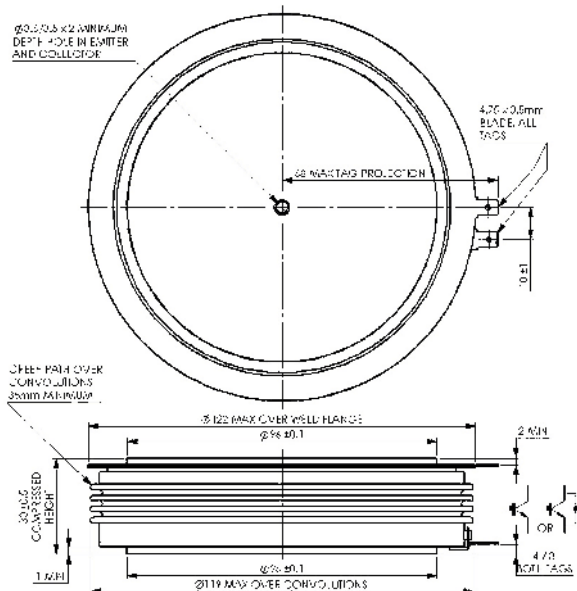

W99 - 100A383

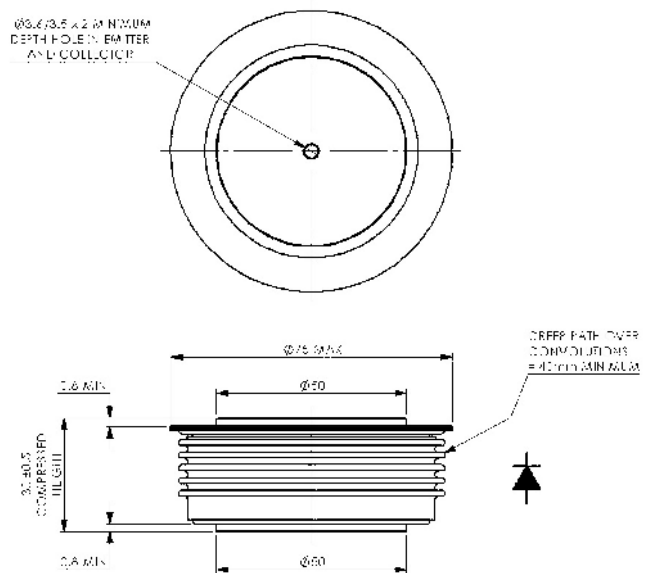

Dimensions in mm and inches (1 mm = 0.0394")

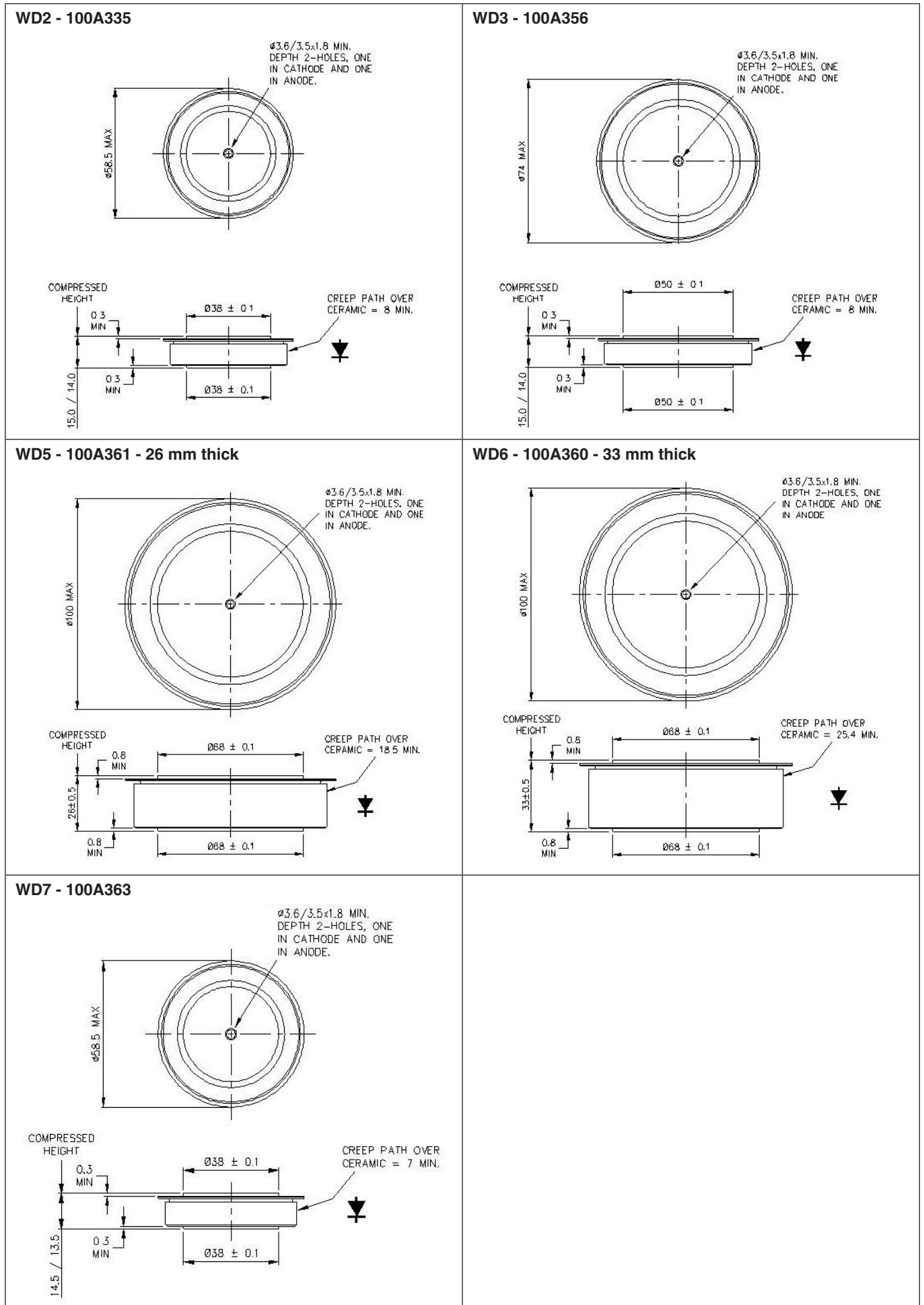

Dimensions in mm and inches (1 mm = 0.0394")

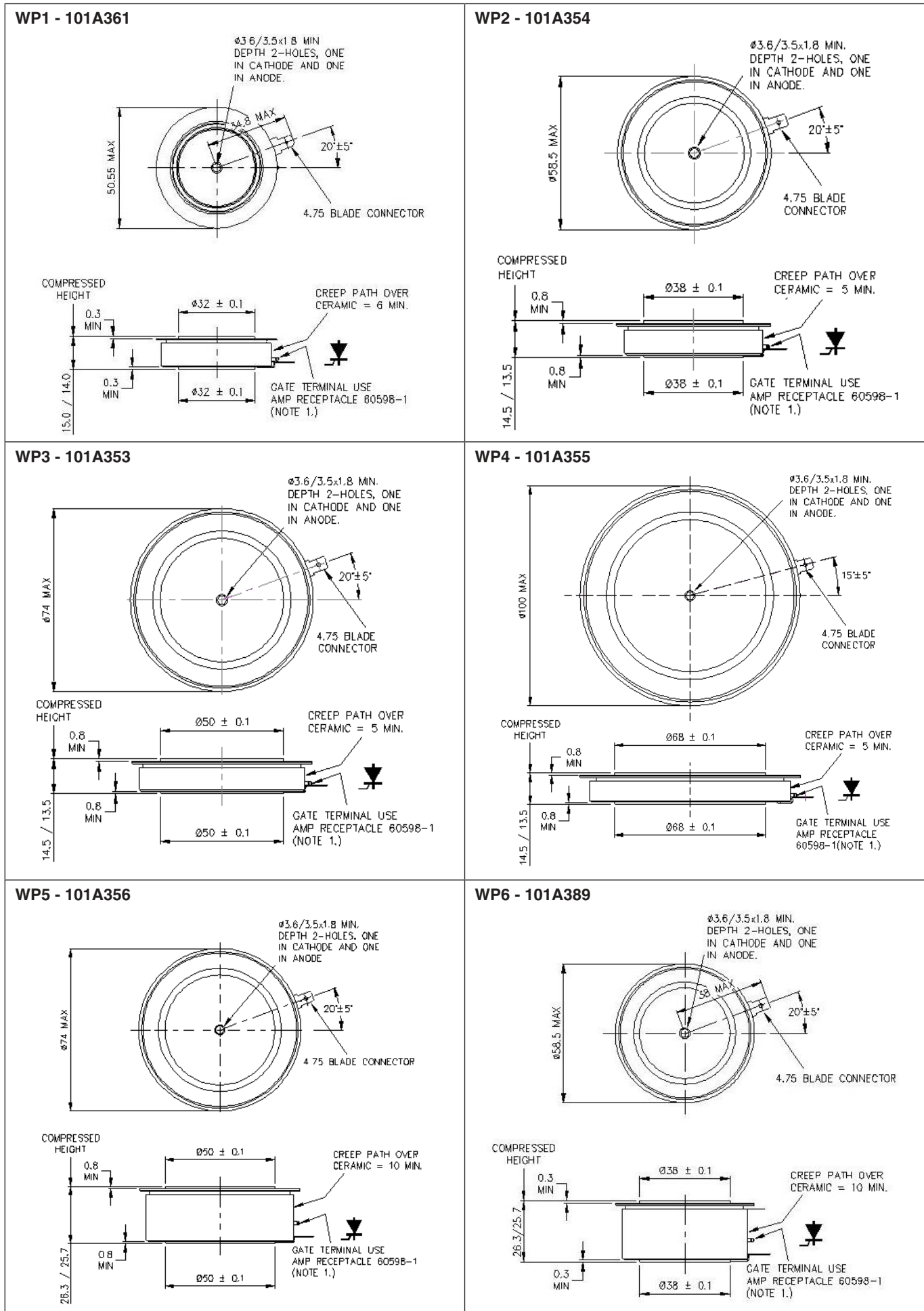

Outline drawings

Dimensions in mm and inches (1 mm = 0.0394")

WC1 - XK0450SA056M

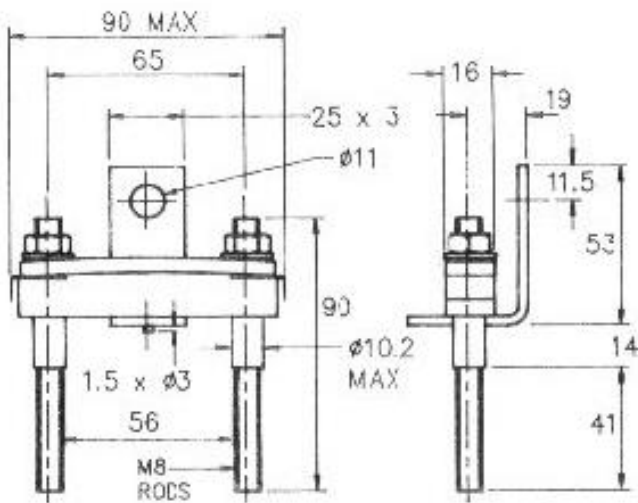

WC2 - XK0450DA056M

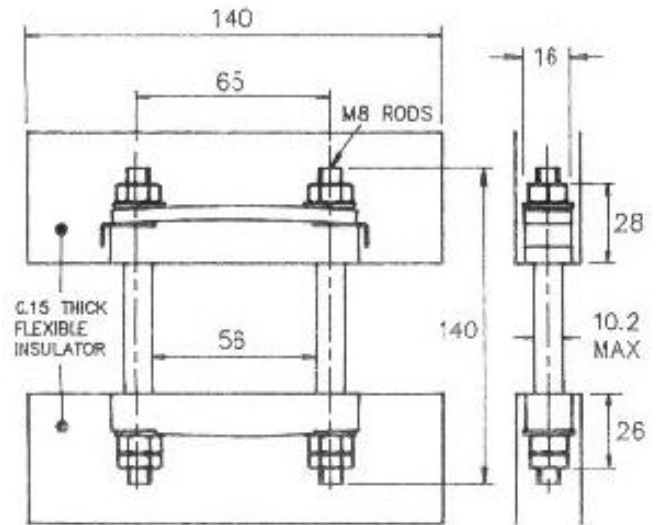

WC3 - XK0450DT056M

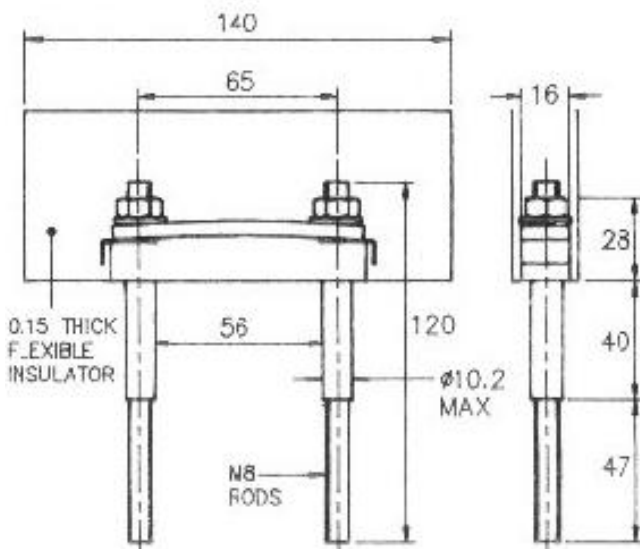

WC4 - XK0550SA056M

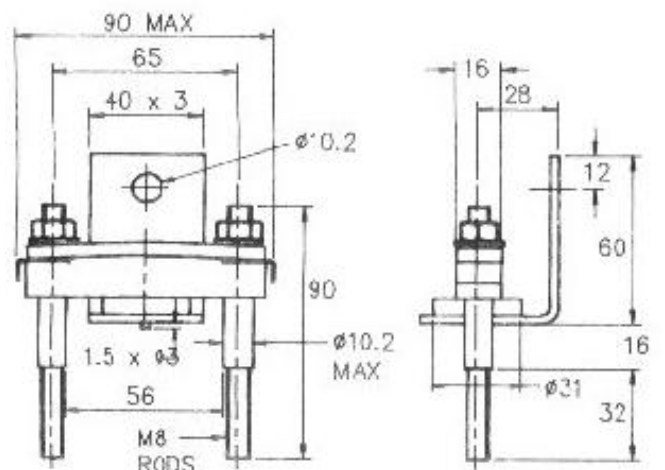

WC5 - XK0550DA056M

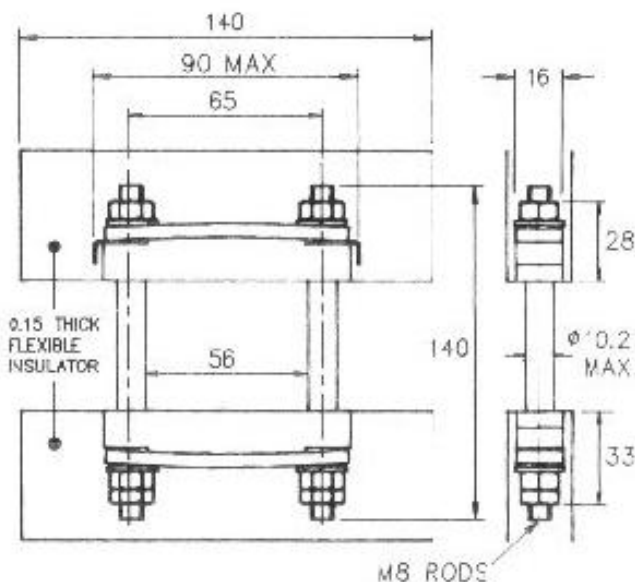

WC6 - XK0900SA056M

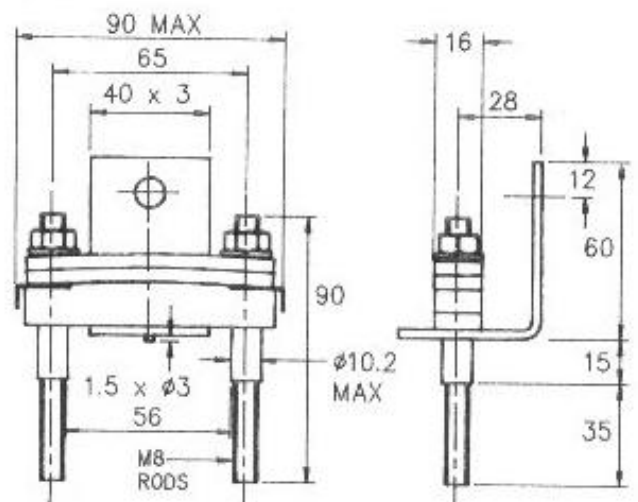

Dimensions in mm and inches (1 mm = 0.0394")

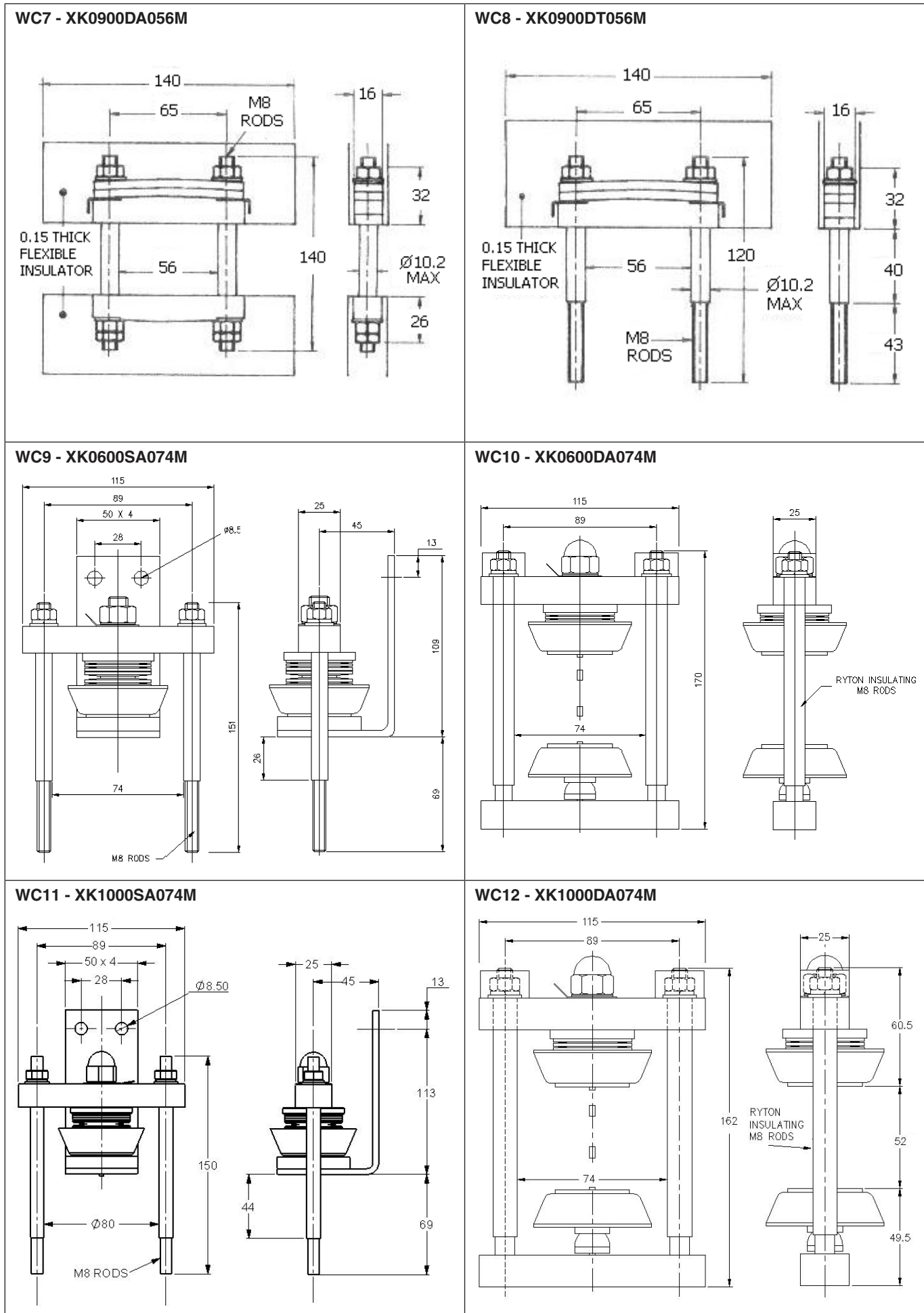

Outline drawings

Dimensions in mm and inches (1 mm = 0.0394")

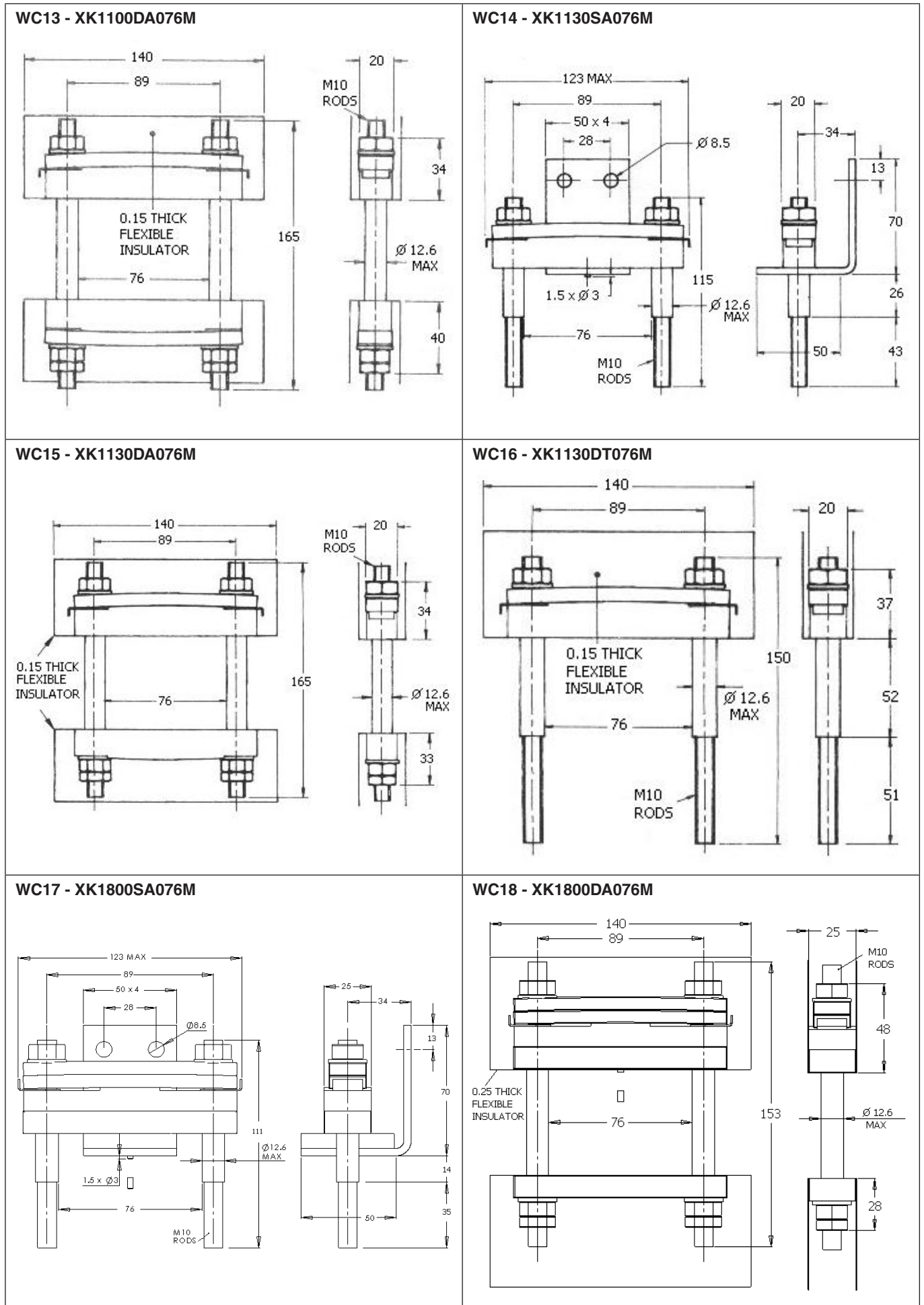

Dimensions in mm and inches (1 mm = 0.0394")

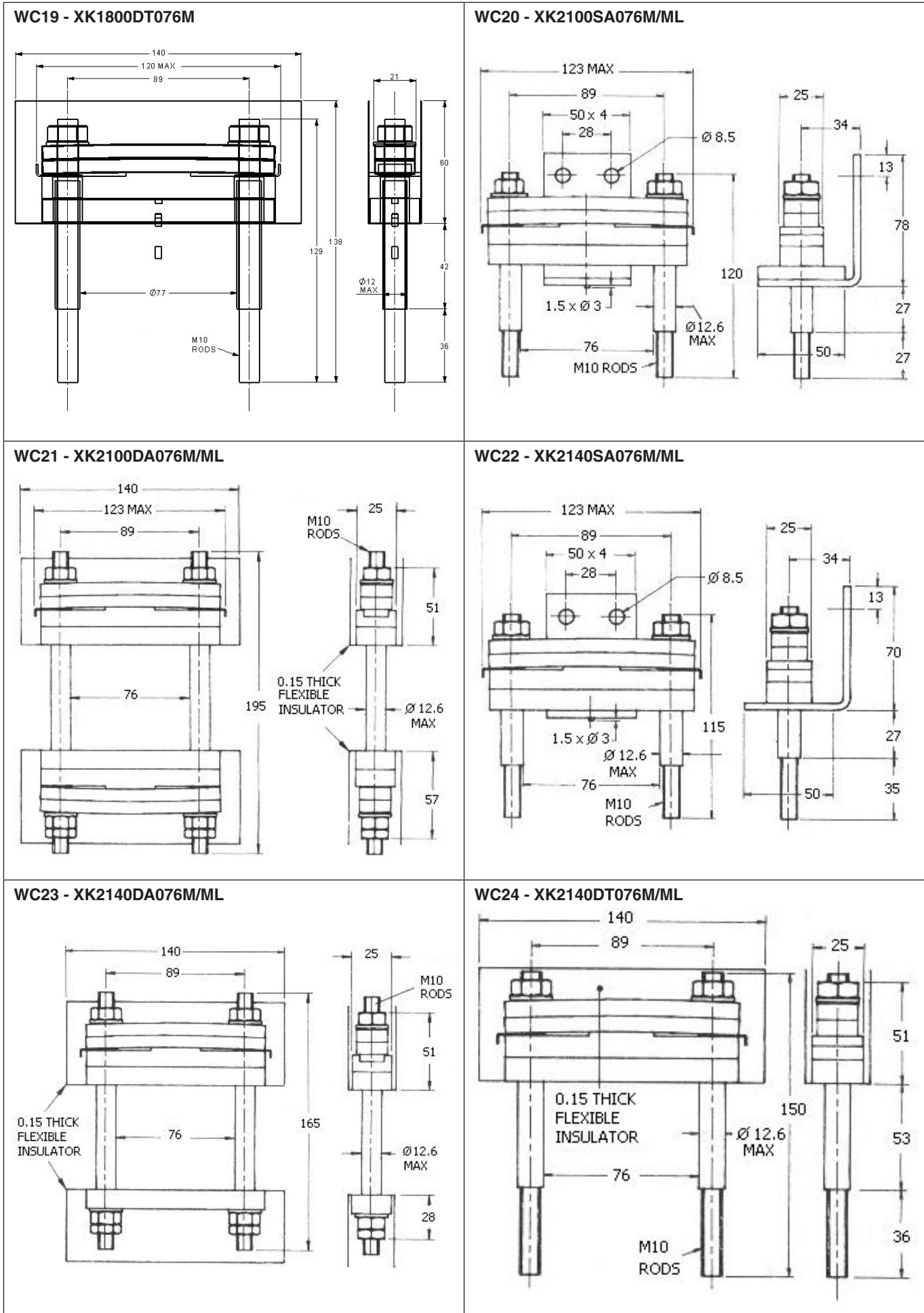

Outline drawings

Dimensions in mm and inches (1 mm = 0.0394")

WC25 - XK2700SA076M

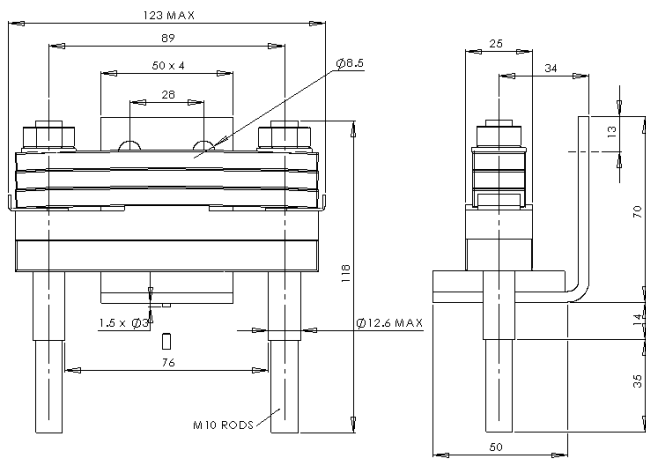

WC26 - XK2700DA076M

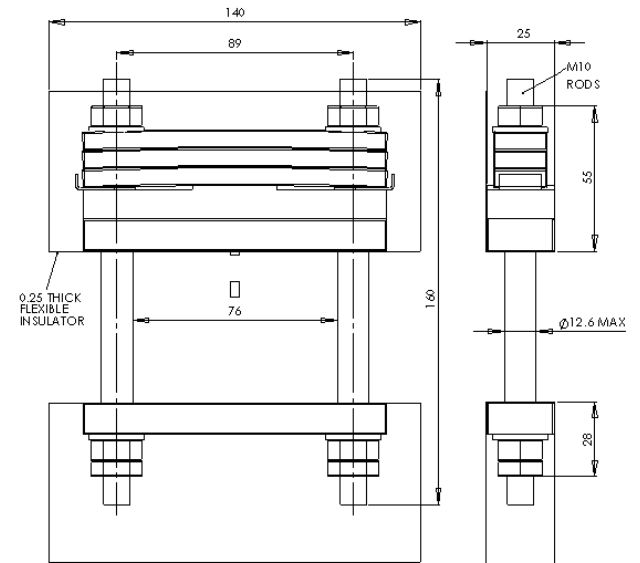

WC27 - XK2700DT076M

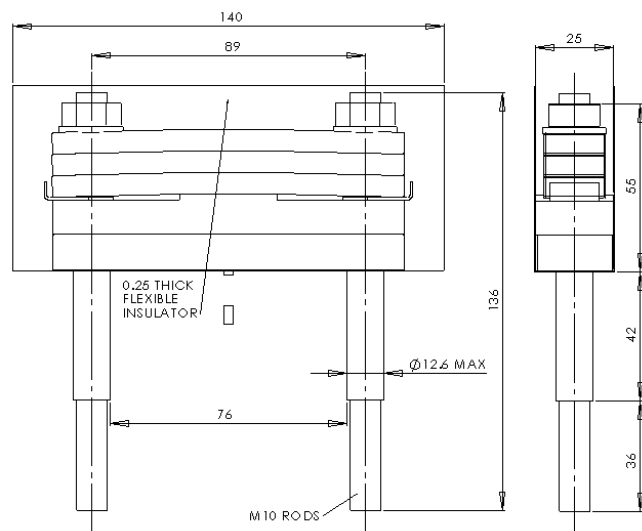

WC28 - XK2000SA114M

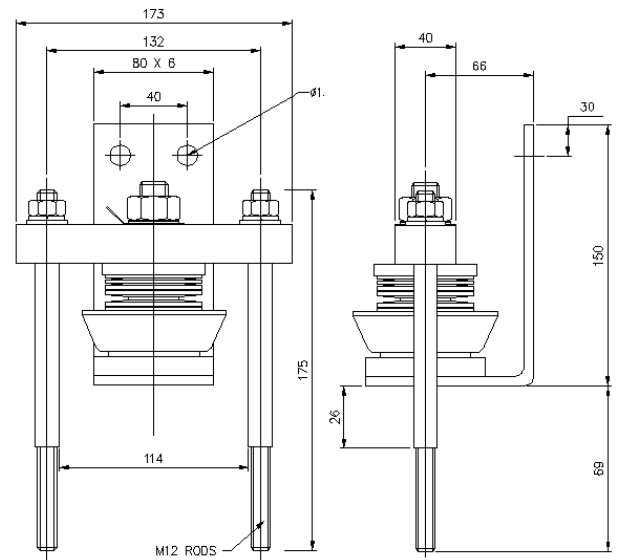

WC29 - XK2000DA114M

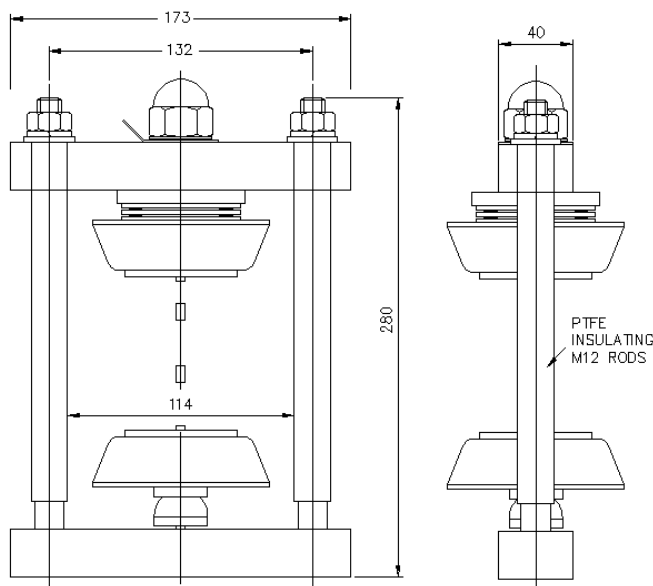

WC30 - XK2500SA114M

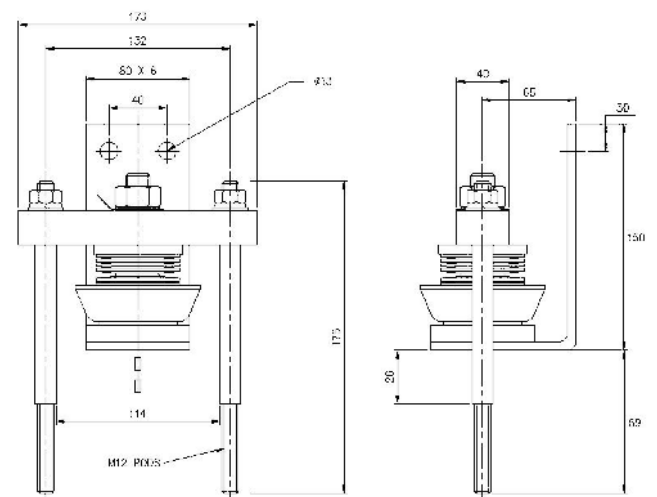

Dimensions in mm and inches (1 mm = 0.0394")

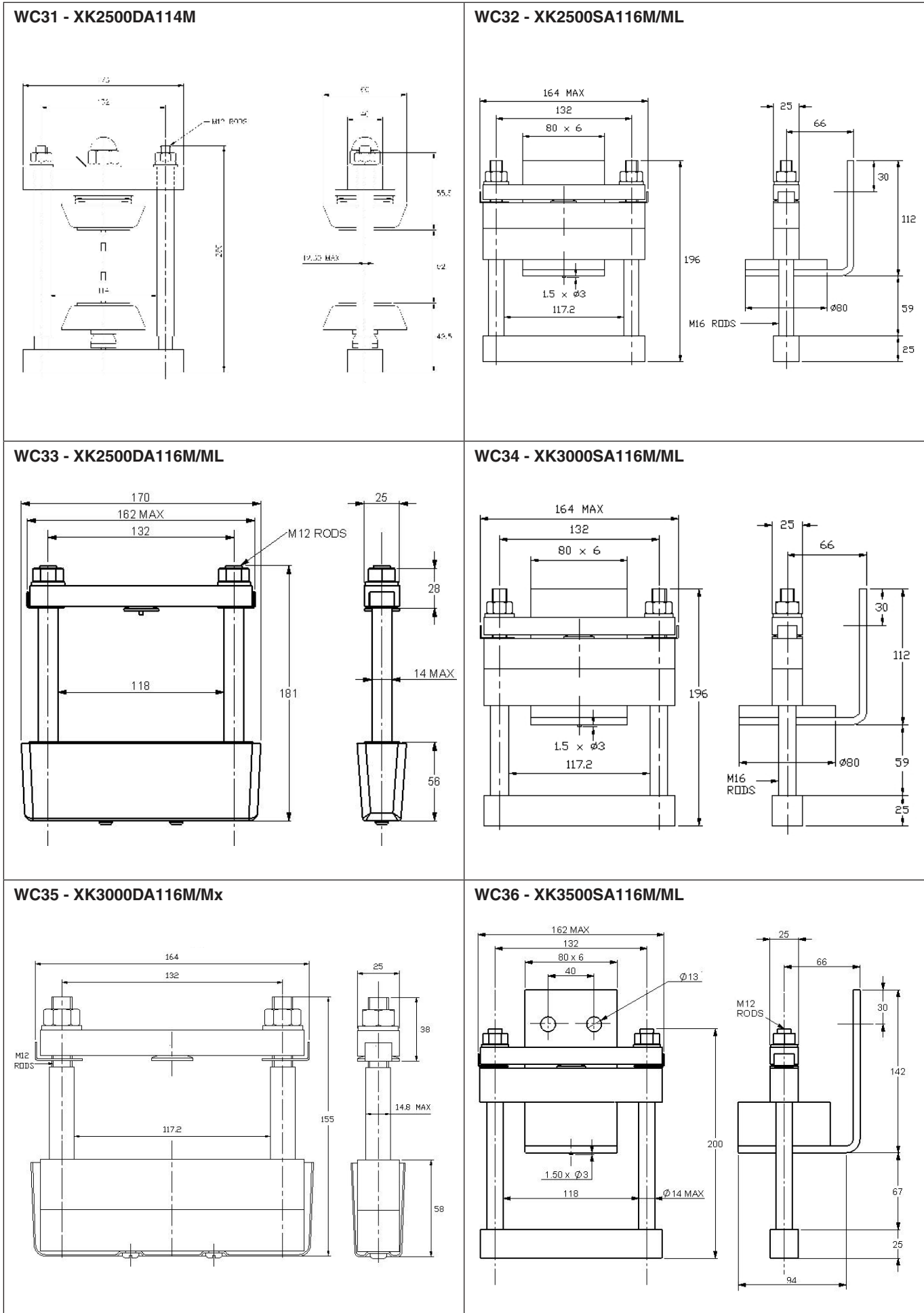

Outline drawings

Dimensions in mm and inches (1 mm = 0.0394")

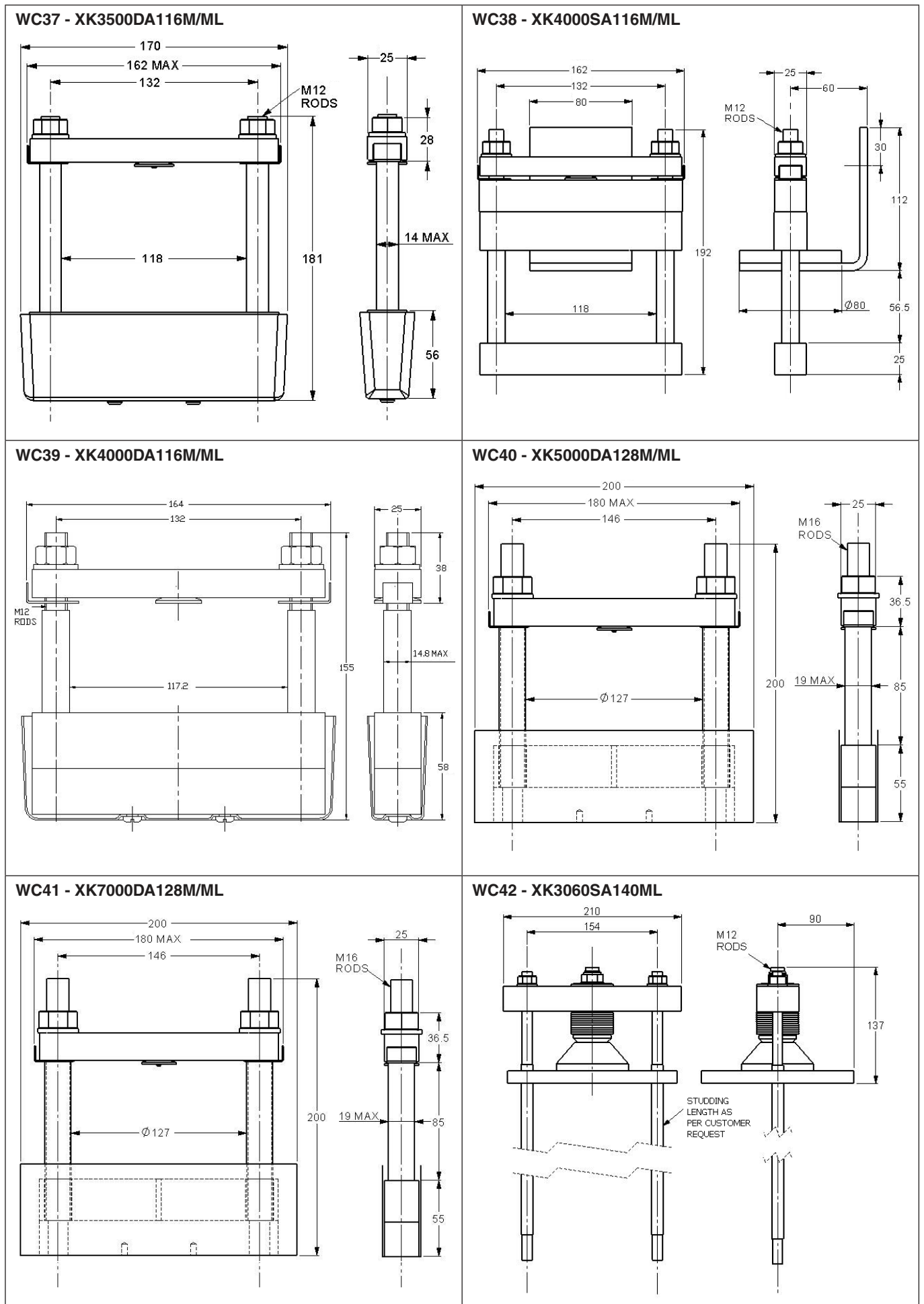

Outline drawings

Dimensions in mm and inches (1 mm = 0.0394")

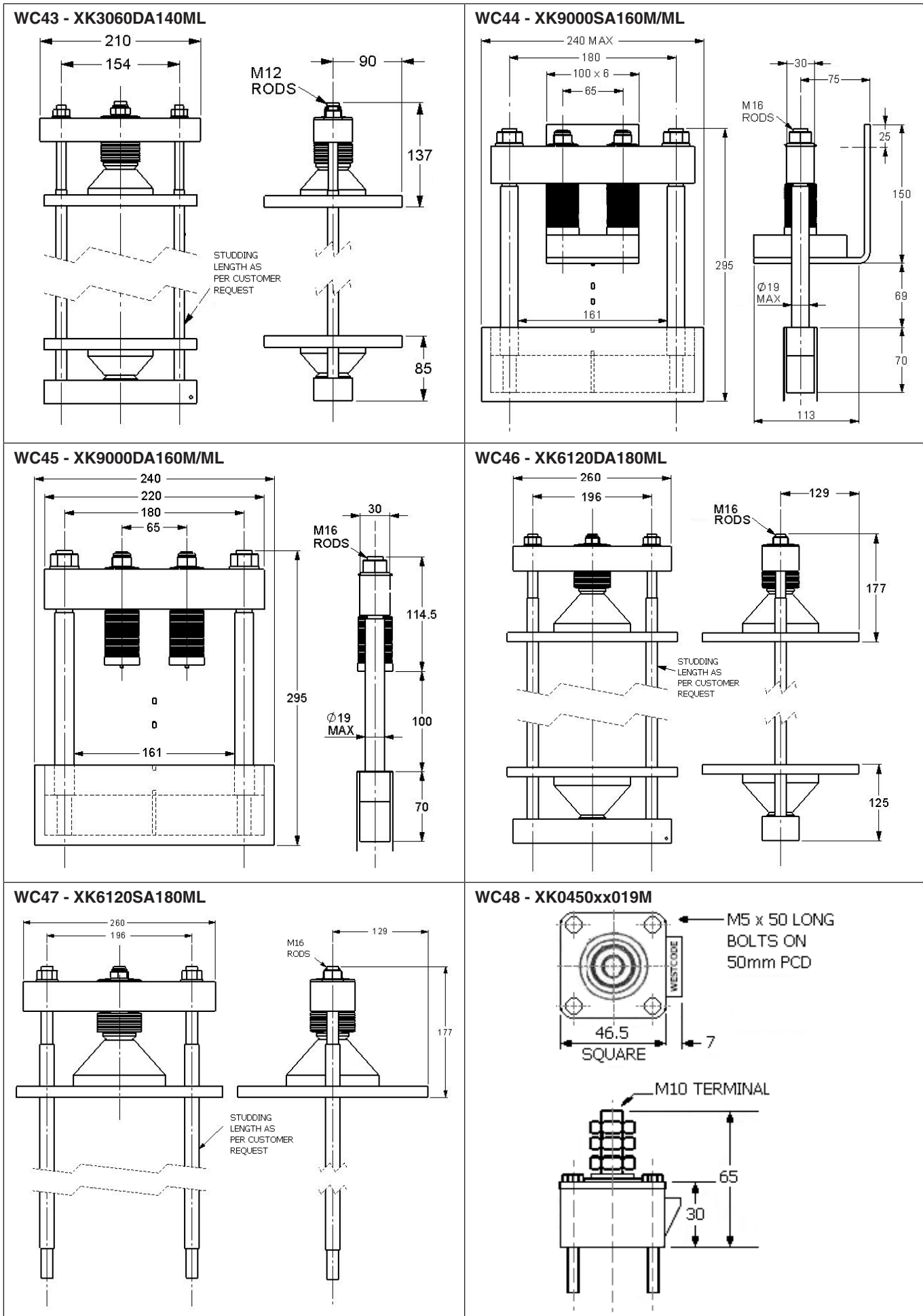

Dimensions in mm and inches (1 mm = 0.0394")

WC49 - XK####xx025M

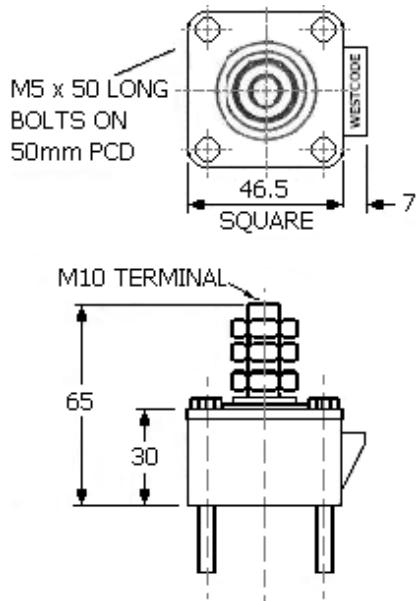

WC50 - XK1500BA034M

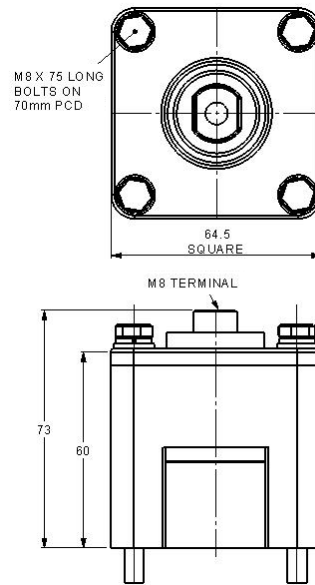

WC51 - XSK1500DA076xxx

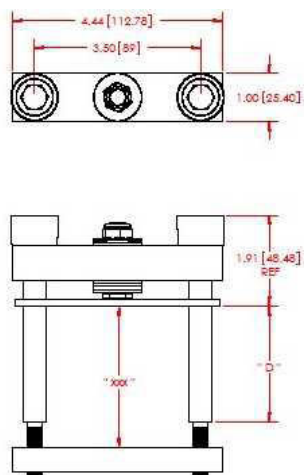

Notes:

1. DIMENSIONS IN INCHES [MILLIMETERS].
2. " Z " DIMENSION CAN BE CHANGED AS PER REQUIREMENT.
3. " D " DIMENSION CAN BE CHANGED AS PER REQUIREMENT.

WC52 - XSK2000DA076xxx

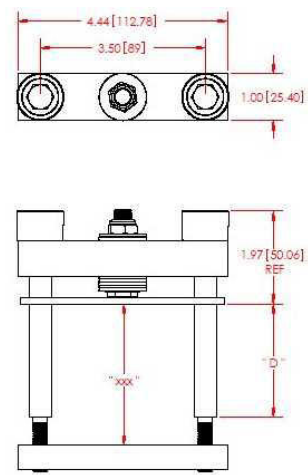

Notes:

1. DIMENSIONS IN INCHES [MILLIMETERS].
2. " Z " DIMENSION CAN BE CHANGED AS PER REQUIREMENT.
3. " D " DIMENSION CAN BE CHANGED AS PER REQUIREMENT.

WC53 - XSK3000DA076xxx

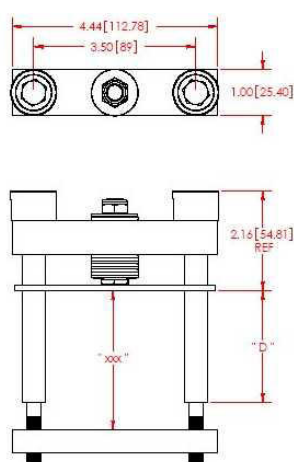

Notes:

1. DIMENSIONS IN INCHES [MILLIMETERS].
2. " Z " DIMENSION CAN BE CHANGED AS PER REQUIREMENT.
3. " D " DIMENSION CAN BE CHANGED AS PER REQUIREMENT.

WC54 - XSK3400DA076xxx

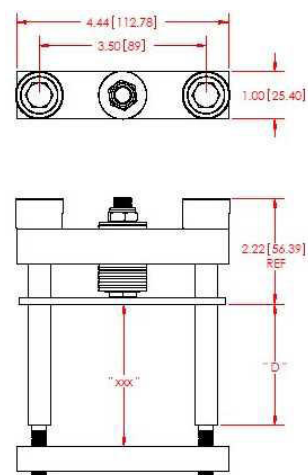

Notes:

1. DIMENSIONS IN INCHES [MILLIMETERS].
2. " Z " DIMENSION CAN BE CHANGED AS PER REQUIREMENT.
3. " D " DIMENSION CAN BE CHANGED AS PER REQUIREMENT.

Dimensions in mm and inches (1 mm = 0.0394")

WC55 - SK3800DA116Mxxx

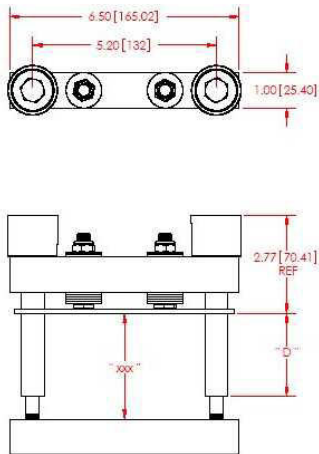

Notes:

1. DIMENSIONS IN INCHES [MILLIMETERS].
2. " Z " DIMENSION CAN BE CHANGED AS PER REQUIREMENT.
3. " D " DIMENSION CAN BE CHANGED AS PER REQUIREMENT.

WC56 - XSK4400DA116Mxxx

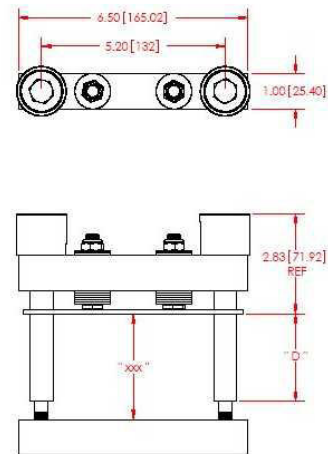

Notes:

1. DIMENSIONS IN INCHES [MILLIMETERS].
2. " Z " DIMENSION CAN BE CHANGED AS PER REQUIREMENT.
3. " D " DIMENSION CAN BE CHANGED AS PER REQUIREMENT.

WC57 - XSK6000DA116Mxxx

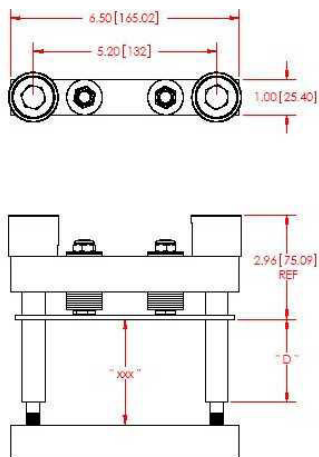

Notes:

1. DIMENSIONS IN INCHES [MILLIMETERS].
2. " Z " DIMENSION CAN BE CHANGED AS PER REQUIREMENT.
3. " D " DIMENSION CAN BE CHANGED AS PER REQUIREMENT.

WC58- DA

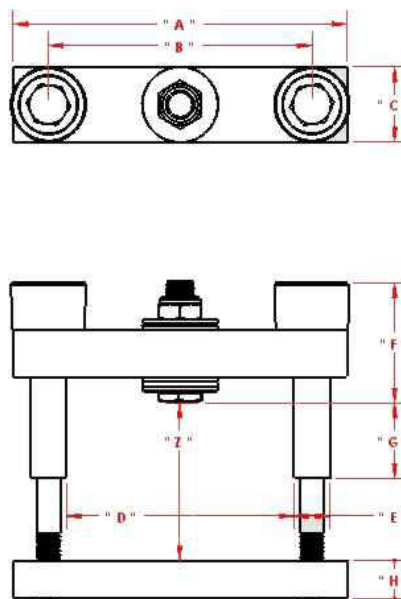

WC59 - DT

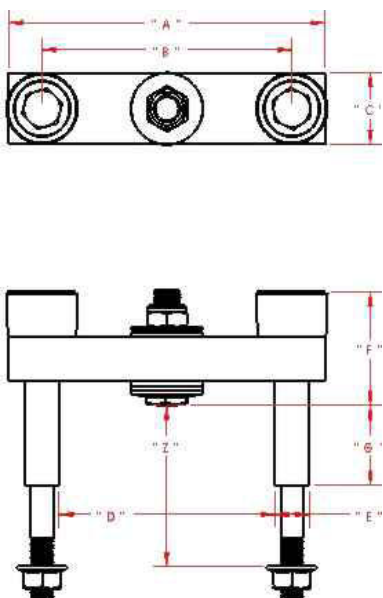

WC60 - DF

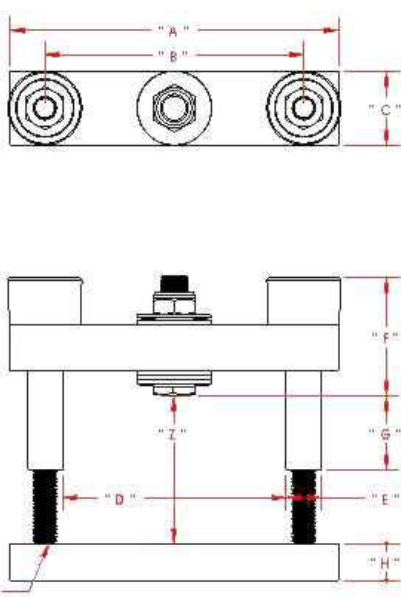

RODS LOCATE INTO THE BOTTOM BAR [ALL THE WAY]

Outline drawings

Dimensions in mm and inches (1 mm = 0.0394")

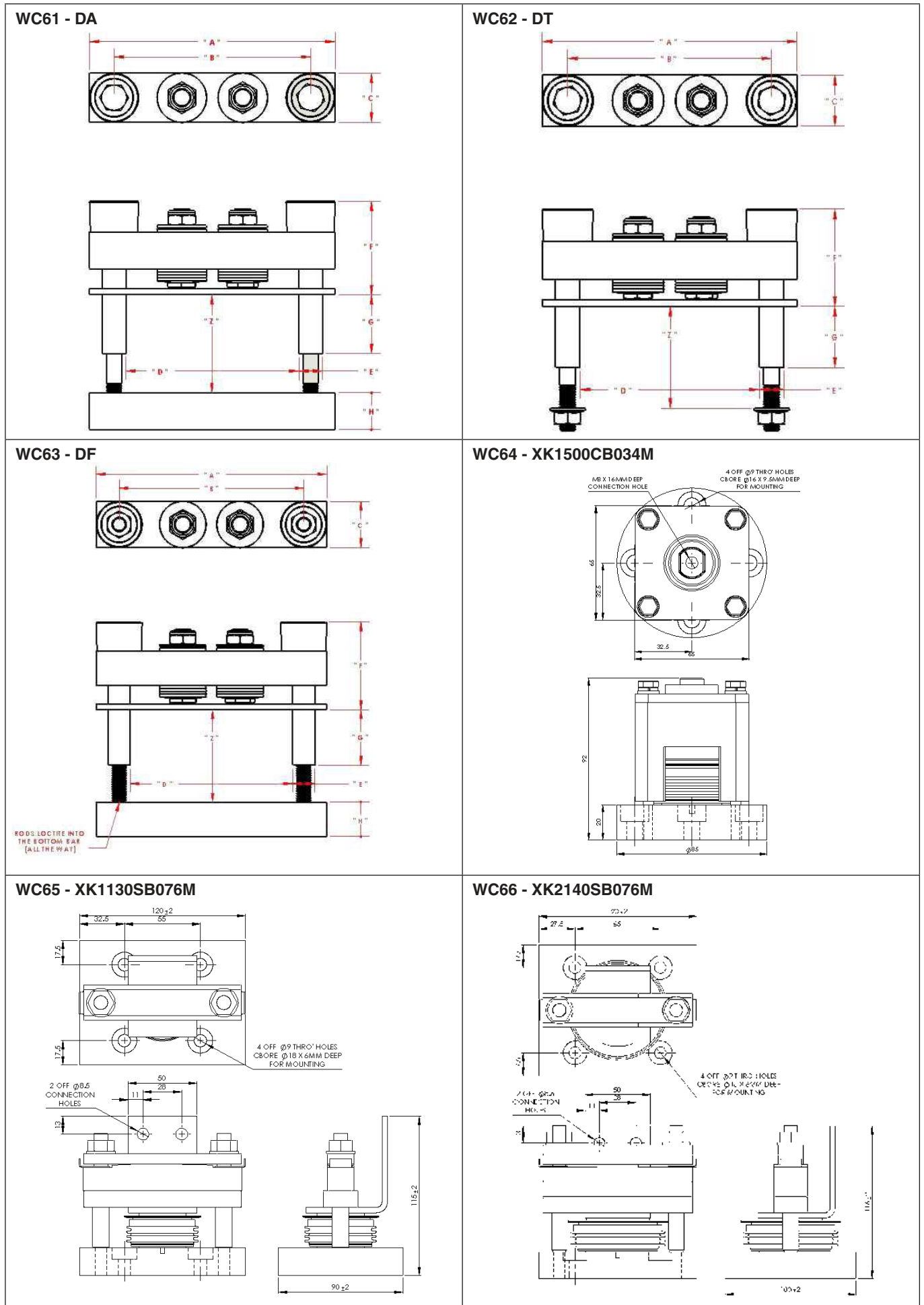

Dimensions in mm and inches (1 mm = 0.0394")

<p>WH1 - G FIN</p>	<p>WH2 - GA FIN</p>	<p>WH3 - H FIN</p>
<p>WH4 - T FIN</p>	<p>WH5 - TB FIN</p>	<p>WH6 - TC FIN</p>
<p>WH7 - LP100</p>	<p>WH8 - WS46</p>	<p>WH9 - WS30 - COPPER</p>

Outline drawings

Dimensions in mm and inches (1 mm = 0.0394")

<p>WCL1 - LK COOLER</p>	<p>WCL2 - LKA COOLER</p>	<p>WCL3 - LKB COOLER</p>
<p>WCL4 - LKC COOLER</p>	<p>WCL5 - LKD COOLER</p>	<p>WCL6 - LKE COOLER</p>
<p>WCL7 - LKF</p>	<p>WCL8 - WS27</p>	<p>WCL9 - WS65 COOLER</p>

Dimensions in mm and inches (1 mm = 0.0394")

<p>WCL10 - WS69 COOLER</p> <p>2 OFF 3/8" BSPP x 34mm DEEP</p> <p>2 HOLES 9°/3</p>	<p>WCL11 - WS70 COOLER</p> <p>2 OFF 3/8" BSPP x 34mm DEEP</p>	<p>WCL12 - WS71-1 COOLER</p> <p>Nozzle suitable for 10mm hose</p>
<p>WCL13 - WS71-2 COOLER</p> <p>Nozzle suitable for 10mm hose</p>	<p>WCL14 - WS72-1 COOLER</p> <p>Nozzle suitable for 10mm hose</p>	<p>WCL15 - WS72-2 COOLER</p> <p>Nozzle suitable for 12mm hose</p>
<p>WCL16 - XW127ExxxA</p> <p>2 OFF 1/4" BSPP x 18mm DEEP</p>	<p>WCL17 - XW127ExxxB</p> <p>2 OFF 1/4" BSPP x 18mm DEEP</p>	<p>WCL18 - XW180GN25A</p>

Dimensions in mm and inches (1 mm = 0.0394")

X007b TO-220 ACFP

Weight = 2 g

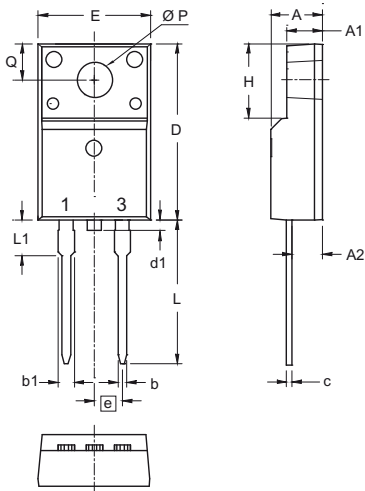

Dim.	Millimeters		Inches	
	min	max	min	max
A	4.50	4.90	0.177	0.193
A1	2.34	2.74	0.092	0.108
A2	2.56	2.96	0.101	0.117
b	0.70	0.90	0.028	0.035
b1	1.27	1.47	0.050	0.058
c	0.45	0.60	0.018	0.024
D	15.67	16.07	0.617	0.633
d1	0.00	1.10	0.000	0.043
E	9.96	10.36	0.392	0.408
e	2.54 BSC		0.100 BSC	
H	6.48	6.88	0.255	0.271
L	12.68	13.28	0.499	0.523
L1	3.03	3.43	0.119	0.135
Ø P	3.08	3.28	0.121	0.129
Q	3.20	3.40	0.126	0.134

X008a TO-262 I²PAK

Weight = 1.5 g

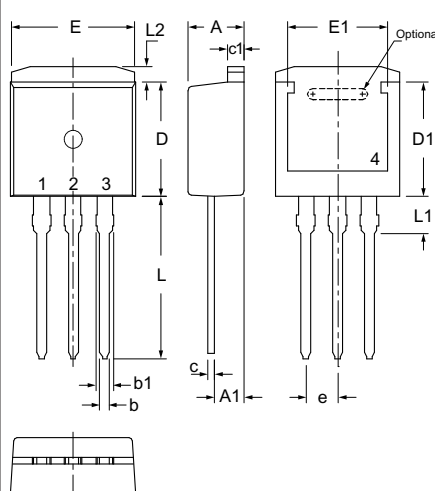

Dim.	Millimeters		Inches	
	min	max	min	max
A	4.30	4.70	0.169	0.185
A1	2.20	2.60	0.087	0.102
b	0.70	0.90	0.028	0.035
b1	1.37	1.57	0.054	0.062
c	0.45	0.60	0.018	0.024
c1	1.25	1.40	0.049	0.055
D	9.00	9.40	0.355	0.370
D1	7.20		0.284	
E	9.70	9.90	0.382	0.390
E1	7.00		0.276	
e	2.54 BSC		0.100 BSC	
L	12.88	13.28	0.507	0.523
L1	3.00	-	0.118	-
L2	1.00	1.40	0.039	0.055

X008b TO-262 I²PAK

Weight = 1.5 g

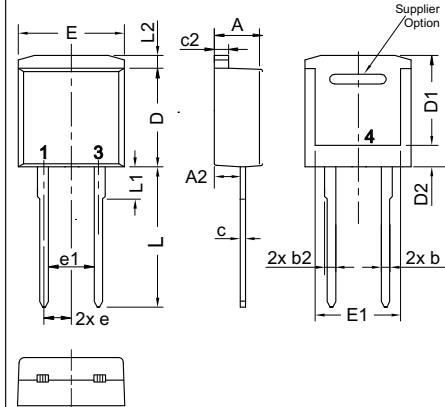

Dim.	Millimeters		Inches	
	min	max	min	max
A	4.06	4.83	0.160	0.190
A2	2.41		0.095	
b	0.51	0.99	0.020	0.039
b2	1.14	1.40	0.045	0.055
c	0.40	0.74	0.016	0.029
c2	1.14	1.40	0.045	0.055
D	8.38	9.40	0.330	0.370
D1	8.00	8.89	0.315	0.350
D2	2.5		0.098	
E	9.65	10.41	0.380	0.410
E1	6.22	8.50	0.245	0.335
e	2.54 BSC		0.100 BSC	
e1	4.28		0.169	
L	13.00	13.60	0.512	0.535
L1	2.90	3.10	0.114	0.122
L2	1.02	1.68	0.040	0.066

All dimensions conform with and/or within JEDEC standard

X009a PLUS220™

Weight = 2.5 g

b) middle leg cut

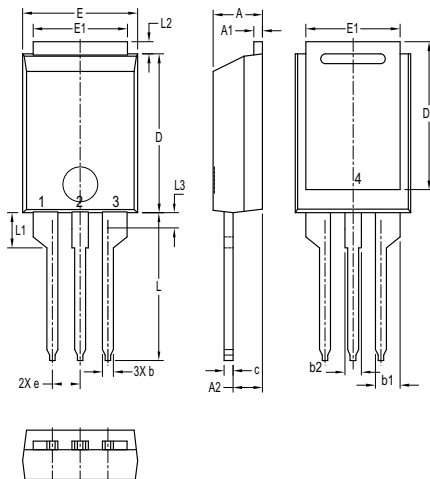

Dim.	Millimeters		Inches	
	min	max	min	max
A	4.30	4.70	0.169	0.185
A1	0.70	0.90	0.028	0.035
A2	2.50	3.00	0.098	0.118
b	0.90	1.20	0.035	0.047
b1	2.03	2.41	0.080	0.095
b2	1.37	1.63	0.054	0.064
c	0.70	0.90	0.028	0.035
D	14.00	15.00	0.551	0.591
D1	13.00	13.70	0.512	0.539
E	10.00	11.00	0.394	0.433
E1	8.40	8.80	0.331	0.346
e	2.54 BSC		0.100 BSC	
L	13.00	14.00	0.512	0.551
L1	3.00	3.50	0.118	0.138
L2	0.90	1.30	0.035	0.051
L3	1.20	1.50	0.047	0.059

X010a ISOPLUS220™ AB

Weight = 2.5 g

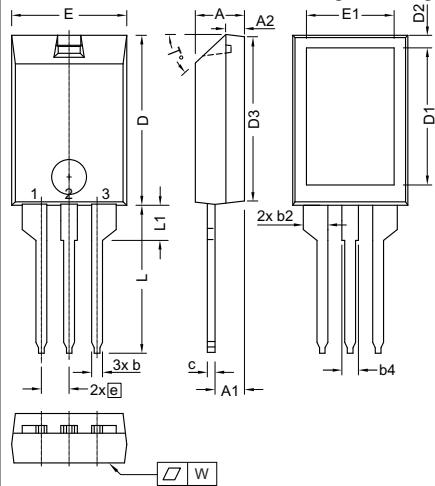

Dim.	Millimeters		Inches	
	min	max	min	max
A	4.00	5.00	0.157	0.197
A1	2.50	3.00	0.098	0.118
A2	1.60	1.80	0.063	0.071
b	0.90	1.30	0.035	0.051
b2	2.35	2.55	0.093	0.100
b4	1.25	1.65	0.049	0.065
c	0.70	1.00	0.028	0.039
D	15.00	16.00	0.591	0.630
D1	12.00	13.00	0.472	0.512
D2	1.10	1.50	0.043	0.059
D3	14.90	15.50	0.587	0.610
E	10.00	11.00	0.394	0.433
E1	7.50	8.50	0.295	0.335
e	2.54 BSC		0.100 BSC	
L	13.00	14.50	0.512	0.571
L1	3.00	3.50	0.118	0.138
T°	42.5	47.5	-	-
W	-	0.10	-	0.004

X010b ISOPLUS220™ AC

Weight = 2.5 g

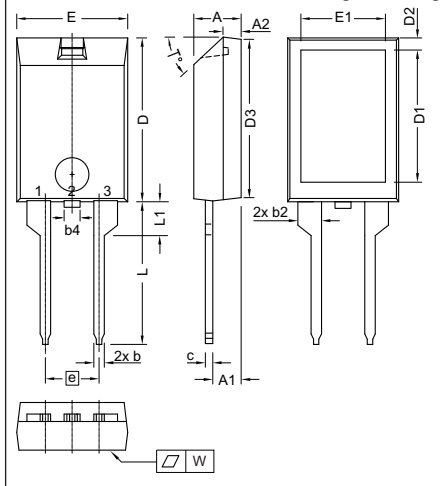

Dim.	Millimeters		Inches	
	min	max	min	max
A	4.00	5.00	0.157	0.197
A1	2.50	3.00	0.098	0.118
A2	1.60	1.80	0.063	0.071
b	0.90	1.30	0.035	0.051
b2	1.25	1.65	0.049	0.065
b4	2.35	2.55	0.093	0.100
c	0.70	1.00	0.028	0.039
D	15.00	16.00	0.591	0.630
D1	12.00	13.00	0.472	0.512
D2	1.10	1.50	0.043	0.059
D3	14.90	15.50	0.587	0.610
E	10.00	11.00	0.394	0.433
E1	7.50	8.50	0.295	0.335
e	5.08 BSC		0.200 BSC	
L	13.00	14.50	0.512	0.571
L1	3.00	3.50	0.118	0.138
T°	42.5	47.5	-	-
W	-	0.10	-	0.004

Dimensions in mm and inches (1 mm = 0.0394")

X011a TO-263 AA (D²PAK) Weight = 1.5 g

Dim.	Millimeter		Inches	
	min	max	min	max
A	4.06	4.83	0.160	0.190
A1	typ. 0.10		typ. 0.004	
b	0.51	0.99	0.020	0.039
b2	1.14	1.40	0.045	0.055
c	0.40	0.74	0.016	0.029
c2	1.14	1.40	0.045	0.055
D	8.38	9.40	0.330	0.370
D1	8.00	8.89	0.315	0.350
E	9.65	10.41	0.380	0.410
E1	6.22	8.13	0.245	0.320
e	2,54 BSC		0,100 BSC	
H	14.61	15.88	0.575	0.625
L	1.78	2.79	0.070	0.110
L1	1.02	1.68	0.040	0.066
W	typ. 0.02	0.040	typ. 0.0008	0.002

X011b TO-263 AB (D²PAK) Weight = 1.5 g

Dim.	Millimeter		Inches	
	min	max	min	max
A	4.06	4.83	0.160	0.190
A1	typ. 0.10		typ. 0.004	
b	0.51	0.99	0.020	0.039
b2	1.14	1.40	0.045	0.055
c	0.40	0.74	0.016	0.029
c2	1.14	1.40	0.045	0.055
D	8.38	9.40	0.330	0.370
D1	8.00	8.89	0.315	0.350
E	9.65	10.41	0.380	0.410
E1	6.22	8.13	0.245	0.320
e	2,54 BSC		0,100 BSC	
H	14.61	15.88	0.575	0.625
L	1.78	2.79	0.070	0.110
L1	1.02	1.68	0.040	0.066
W	typ. 0.02	0.040	typ. 0.0008	0.002

X011c TO-263 AB (D²PAK) Weight = ?? g

Dim.	Millimeters		Inches	
	min	max	min	max
A	4.06	4.83	0.160	0.190
A1	typ 0.10		typ 0.004	
A2	2.41		0.095	
b	0.51	0.99	0.020	0.039
b2	1.14	1.40	0.045	0.055
c	0.40	0.74	0.016	0.029
c2	1.14	1.40	0.045	0.055
D	8.38	9.40	0.330	0.370
D1	8.00	8.89	0.315	0.350
D2	2.5		0.098	
E	9.65	10.41	0.380	0.410
E1	6.22	8.50	0.245	0.335
e	2.54 BSC		0.100 BSC	
e1	4.28		0.169	
H	14.61	15.88	0.575	0.625
L	1.78	2.79	0.070	0.110
L2	1.02	1.68	0.040	0.066
W	typ 0.02	0.040	typ 0.0008	0.002

All dimensions conform with and/or within JEDEC standard

X012a TO-263 (5) Weight = 1.5 g

Dim.	Millimeter		Inches	
	min	max	min	max
A	4.20	4.80	0.160	0.190
A1	2.10	2.70	0.083	0.106
b	0.60	0.99	0.024	0.039
c	0.40	0.70	0.016	0.028
c2	1.20	1.40	0.047	0.055
D	8.80	9.50	0.346	0.374
D1	6.60	7.20	0.260	0.283
E	9.65	10.30	0.380	0.406
E1	7.50	8.20	0.295	0.323
e	1.70 BSC		0.067 BSC	
L	14.80	15.80	0.583	0.622
L1	2.24	2.84	0.088	0.112
L2	1.00	1.40	0.039	0.067
L3	1.20	1.70	0.047	0.067

X012b TO-263 (7) c) middle leg cut Weight = 2.5 g

Dim.	Millimeter		Inches	
	min	max	min	max
A	4.20	4.60	0.165	0.181
A1	2.45	2.75	0.096	0.108
b	0.65	0.90	0.026	0.035
c	0.40	0.60	0.016	0.024
c2	1.14	1.40	0.045	0.055
D	8.38	8.64	0.330	0.340
D1	6.10	6.35	0.240	0.250
E	10.00	10.30	0.394	0.406
E1	7.34	8.00	0.290	0.315
e	1.27 BSC		0.050 BSC	
L	14.73	15.75	0.580	0.620
L1	2.24	2.84	0.088	0.112
L2	1.35	1.55	0.053	0.061

X013 PLUS220™ (SMD) Weight = 2 g

Dim.	Millimeter		Inches	
	min	max	min	max
A	4.30	4.70	0.169	0.185
A1	0.70	0.90	0.028	0.035
A2	2.50	3.00	0.098	0.118
A3	0.00	0.25	0.000	0.010
b	0.90	1.20	0.035	0.047
b1	2.03	2.41	0.080	0.095
b2	1.37	1.63	0.054	0.064
c	0.70	0.90	0.028	0.035
D	14.00	15.00	0.551	0.591
D1	13.00	13.70	0.512	0.539
E	10.00	11.00	0.394	0.433
E1	8.40	8.80	0.331	0.346
e	5.08 BSC		0.200 BSC	
L	5.30	5.80	0.209	0.228
L1	3.00	3.50	0.118	0.138
L2	0.90	1.30	0.035	0.051
L3	1.20	1.50	0.047	0.059
L4	1.00	1.50	0.039	0.059

Dimensions in mm and inches (1 mm = 0.0394")

X014a TO-247 AD Weight = 6 g

Dim.	Millimeter		Inches	
	min	max	min	max
A	4.70	5.30	0.185	0.209
A1	2.21	2.59	0.087	0.102
A2	1.50	2.49	0.059	0.098
b	0.99	1.40	0.039	0.055
b2	1.65	2.39	0.065	0.094
b4	2.59	3.43	0.102	0.135
c	0.38	0.89	0.015	0.035
D	20.79	21.45	0.819	0.845
D1	13.07	-	0.515	-
D2	0.51	1.35	0.020	0.053
E	15.48	16.24	0.610	0.640
E1	13.45	-	0.53	-
E2	4.31	5.48	0.170	0.216
e	5.45 BSC		0.215 BSC	
L	19.80	20.30	0.078	0.800
L1	-	4.49	-	0.177
Ø P	3.55	3.65	0.140	0.144
Ø P1	-	7.39	-	0.290
Q	5.38	6.19	0.212	0.244
S	6.14 BSC		0.242 BSC	

X014b TO-247 AD Weight = 6 g

Dim.	Millimeter		Inches	
	min	max	min	max
A	4.70	5.30	0.185	0.209
A1	2.21	2.59	0.087	0.102
A2	1.50	2.49	0.059	0.098
b	0.99	1.40	0.039	0.055
b2	1.65	2.39	0.065	0.094
b4	2.59	3.43	0.102	0.135
c	0.38	0.89	0.015	0.035
D	20.79	21.45	0.819	0.845
D1	13.07	-	0.515	-
D2	0.51	1.35	0.020	0.053
E	15.48	16.24	0.610	0.640
E1	13.45	-	0.530	-
E2	4.31	5.48	0.170	0.216
e	10.90 BSC		0.430 BSC	
L	19.80	20.30	0.078	0.800
L1	-	4.49	-	0.177
Ø P	3.55	3.65	0.140	0.144
Ø P1	-	7.39	-	0.290
Q	5.38	6.19	0.212	0.244
S	6.14 BSC		0.242 BSC	

X014c TO-247 AD Weight = 6 g

Dim.	Millimeter		Inches	
	min	max	min	max
A	4.90	5.10	0.193	0.201
A1	2.90	3.10	0.114	0.122
A2	1.90	2.10	0.075	0.083
A3	0.90	1.10	0.035	0.043
b	1.35	1.50	0.053	0.059
b1	1.90	2.10	0.075	0.083
c	0.55	0.75	0.022	0.030
D	20.80	21.40	0.819	0.843
D1	16.20	16.40	0.638	0.646
D2	3.40	3.70	0.134	0.146
D3	1.40	1.60	0.055	0.063
E	15.80	16.20	0.622	0.638
E1	13.20	13.40	0.520	0.528
E2	3.00	3.20	0.118	0.126
E3	1.30	1.50	0.051	0.059
e	2.54 BSC		0.100 BSC	
e1	7.62 BSC		0.300 BSC	
L	18.60	19.00	0.732	0.748
L1	2.70	3.00	0.106	0.118
Ø P	3.50	3.60	0.138	0.142
Ø P1	6.90	7.10	0.272	0.280
Q	5.50	5.70	0.216	0.224
R	4.20	4.30	0.165	0.169
S	6.10	6.30	0.240	0.248

X015a PLUS247™ Weight = 7 g

Dim.	Millimeter		Inches	
	min	max	min	max
A	4.83	5.21	0.190	0.205
A1	2.29	2.54	0.090	0.100
A2	1.91	2.16	0.075	0.085
b	1.14	1.40	0.045	0.055
b1	1.90	2.10	0.075	0.084
b2	2.92	3.12	0.115	0.123
C	0.60	0.80	0.024	0.031
D	20.80	21.34	0.819	0.840
E	15.75	16.13	0.620	0.635
e	5.45 BSC		0.215 BSC	
L	19.80	20.30	0.078	0.800
L1	3.80	4.30	0.150	0.170
Q	5.60	6.20	0.220	0.244
R	4.32	4.83	0.170	0.190

X015c PLUS247™ Weight = 7 g

Dim.	Millimeter		Inches	
	min	max	min	max
A	4.90	5.10	0.193	0.201
A1	2.90	3.10	0.114	0.122
A2	1.90	2.10	0.075	0.083
A3	0.90	1.10	0.035	0.043
b	1.35	1.50	0.053	0.059
b1	1.90	2.10	0.075	0.083
c	0.55	0.75	0.022	0.030
D	20.80	21.40	0.819	0.843
D1	16.20	16.40	0.638	0.646
D2	3.40	3.70	0.134	0.146
D3	1.40	1.60	0.055	0.063
E	15.80	16.20	0.622	0.638
E1	13.20	13.40	0.520	0.528
E2	3.00	3.20	0.118	0.126
E3	1.30	1.50	0.051	0.059
e	2.54 BSC		0.100 BSC	
e1	7.62 BSC		0.300 BSC	
L	18.60	19.00	0.732	0.748
L1	2.70	3.00	0.106	0.118
Q	5.50	5.70	0.216	0.224
R	4.20	4.30	0.165	0.169

X016a ISOPLUS247™ Weight = 4.5 g

Dim.	Millimeter		Inches	
	min	max	min	max
A	4.83	5.21	0.190	0.205
A1	2.29	2.54	0.090	0.100
A2	1.91	2.16	0.075	0.085
b	1.14	1.40	0.045	0.055
b2	1.91	2.20	0.075	0.087
b4	2.92	3.24	0.115	0.128
c	0.61	0.83	0.024	0.033
D	20.80	21.34	0.819	0.840
D1	15.75	16.26	0.620	0.640
D2	1.65	2.15	0.065	0.085
D3	20.30	20.70	0.799	0.815
E	15.75	16.13	0.620	0.635
E1	13.21	13.72	0.520	0.540
e	5.45 BSC		0.215 BSC	
L	19.81	20.60	0.780	0.811
L1	3.81	4.38	0.150	0.172
Q	5.59	6.20	0.220	0.244
R	4.25	5.50	0.167	0.217
W	-	0.10	-	0.004

Dimensions in mm and inches (1 mm = 0.0394")

X022a ISOPLUS264™ Weight = 7.5 g

Dim.	Millimeter		Inches	
	min	max	min	max
A	4.83	5.21	0.190	0.205
A1	2.59	3.00	0.102	0.118
A2	1.17	1.40	0.046	0.055
b	1.14	1.40	0.045	0.055
b1	1.60	1.83	0.063	0.072
b2	2.54	2.79	0.100	0.110
b3	1.47	1.73	0.058	0.068
c	0.51	0.74	0.020	0.029
D	25.91	26.42	1.020	1.040
E	19.56	20.29	0.770	0.799
e	3.81 BSC		0.150 BSC	
L	19.81	21.83	0.780	0.820
L1	2.03	2.59	0.080	0.102
Q	5.33	5.97	0.210	0.235
Q1	12.45	13.03	0.490	0.513
R	3.81	4.57	0.150	0.180
R1	2.54	3.30	0.100	0.130
S	16.97	17.53	0.668	0.690
T	20.34	20.85	0.801	0.821
U	1.65	2.03	0.065	0.080

X022 ISOPLUS264™ Weight = 7.5 g

c) 5 pin
d) 3 (sym) w/o pin 2 & 4
e) 3 (HV) w/o pin 3 & 4

Dim.	Millimeter		Inches	
	min	max	min	max
A	4.83	5.21	0.190	0.205
A1	2.59	3.00	0.102	0.118
A2	1.17	1.40	0.046	0.055
b	1.14	1.40	0.045	0.055
b1	1.60	1.83	0.063	0.072
b2	2.54	2.79	0.100	0.110
b3	1.47	1.73	0.058	0.068
c	0.51	0.74	0.020	0.029
D	25.91	26.42	1.020	1.040
E	19.56	20.29	0.770	0.799
e	3.81 BSC		0.150 BSC	
L	19.81	21.83	0.780	0.820
L1	2.03	2.59	0.080	0.102
Q	5.33	5.97	0.210	0.235
Q1	12.45	13.03	0.490	0.513
R	3.81	4.57	0.150	0.180
R1	2.54	3.30	0.100	0.130
S	16.97	17.53	0.668	0.690
T	20.34	20.85	0.801	0.821
U	1.65	2.03	0.065	0.080

X024a ISOPLUS i4-PAC™ Weight = 6 g

Dim.	Millimeter		Inches	
	min	max	min	max
A	4.83	5.21	0.190	0.205
A1	2.59	3.00	0.102	0.118
A2	1.17	2.16	0.046	0.085
b	1.14	1.40	0.045	0.055
b2	1.47	1.73	0.058	0.068
b4	2.54	2.79	0.100	0.110
c	0.51	0.74	0.020	0.029
D	20.80	21.34	0.819	0.840
D1	14.99	15.75	0.590	0.620
D2	1.65	2.03	0.065	0.080
D3	20.30	20.70	0.799	0.815
E	19.56	20.29	0.770	0.799
E1	16.76	17.53	0.660	0.690
e	3.81 BSC		0.150 BSC	
L	19.81	21.34	0.780	0.840
L1	2.11	2.59	0.083	0.102
Q	5.33	6.20	0.210	0.244
R	2.54	4.57	0.100	0.180
W	-	0.10	-	0.004

X024b ISOPLUS i4-PAC™ Weight = 5.5 g

Dim.	Millimeter		Inches	
	min	max	min	max
A	4.83	5.21	0.190	0.205
A1	2.59	3.00	0.102	0.118
A2	1.17	2.16	0.046	0.085
b	1.14	1.40	0.045	0.055
b2	1.47	1.73	0.058	0.068
b4	2.54	2.79	0.100	0.110
c	0.51	0.74	0.020	0.029
D	20.80	21.34	0.819	0.840
D1	14.99	15.75	0.590	0.620
D2	1.65	2.03	0.065	0.080
D3	20.30	20.70	0.799	0.815
E	19.56	20.29	0.770	0.799
E1	16.76	17.53	0.660	0.690
e	7.62 BSC		0.300 BSC	
L	19.81	21.34	0.780	0.840
L1	2.11	2.59	0.083	0.102
Q	5.33	6.20	0.210	0.244
R	2.54	4.57	0.100	0.180
W	-	0.10	-	0.004

X024c ISOPLUS i4-PAC™ Weight = 5.5 g

* middle pin cut or not existing depending on assembly line

Dim.	Millimeter		Inches	
	min	max	min	max
A	4.83	5.21	0.190	0.205
A1	2.59	3.00	0.102	0.118
A2	1.17	2.16	0.046	0.085
b	1.14	1.40	0.045	0.055
b2	1.47	1.73	0.058	0.068
b4*	2.54	2.79	0.100	0.110
c	0.51	0.74	0.020	0.029
D	20.80	21.34	0.819	0.840
D1	14.99	15.75	0.590	0.620
D2	1.65	2.03	0.065	0.080
D3	20.30	20.70	0.799	0.815
E	19.56	20.29	0.770	0.799
E1	16.76	17.53	0.660	0.690
e	3.81 BSC		0.150 BSC	
e1	11.43 BSC		0.450 BSC	
L	19.81	21.34	0.780	0.840
L1	2.11	2.59	0.083	0.102
Q	5.33	6.20	0.210	0.244
R	2.54	4.57	0.100	0.180
W	-	0.10	-	0.004

Dimensions in mm and inches (1 mm = 0.0394")

X024d ISOPLUS i4-PAC™ Weight = 6 g

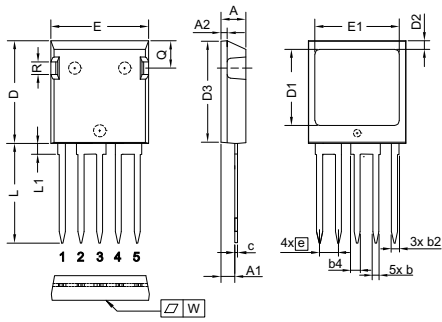

Dim.	Millimeter		Inches	
	min	max	min	max
A	4.83	5.21	0.190	0.205
A1	2.59	3.00	0.102	0.118
A2	1.17	2.16	0.046	0.085
b	1.14	1.40	0.045	0.055
b2	1.47	1.73	0.058	0.068
c	0.51	0.74	0.020	0.029
D	20.80	21.34	0.819	0.840
D1	14.99	15.75	0.590	0.620
D2	1.65	2.03	0.065	0.080
D3	20.30	20.70	0.799	0.815
E	19.56	20.29	0.770	0.799
E1	16.76	17.53	0.660	0.690
e	3.81 BSC		0.150 BSC	
L	19.81	21.34	0.780	0.840
L1	2.11	2.59	0.083	0.102
Q	5.33	6.20	0.210	0.244
R	2.54	4.57	0.100	0.180
W	-	0.10	-	0.004

X024e ISOPLUS i4-PAC™ Weight = 6 g

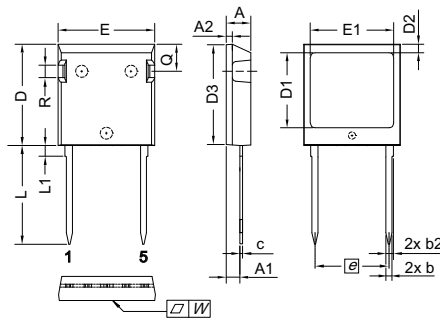

Dim.	Millimeter		Inches	
	min	max	min	max
A	4.83	5.21	0.190	0.205
A1	2.59	3.00	0.102	0.118
A2	1.17	2.16	0.046	0.085
b	1.14	1.40	0.045	0.055
b2	1.47	1.73	0.058	0.068
c	0.51	0.74	0.020	0.029
D	20.80	21.34	0.819	0.840
D1	14.99	15.75	0.590	0.620
D2	1.65	2.03	0.065	0.080
D3	20.30	20.70	0.799	0.815
E	19.56	20.29	0.770	0.799
E1	16.76	17.53	0.660	0.690
e	15.24 BSC		0.600 BSC	
L	19.81	21.34	0.780	0.840
L1	2.11	2.59	0.083	0.102
Q	5.33	6.20	0.210	0.244
R	2.54	4.57	0.100	0.180
W	-	0.10	-	0.004

X025a GBFP

Weight = 7 g

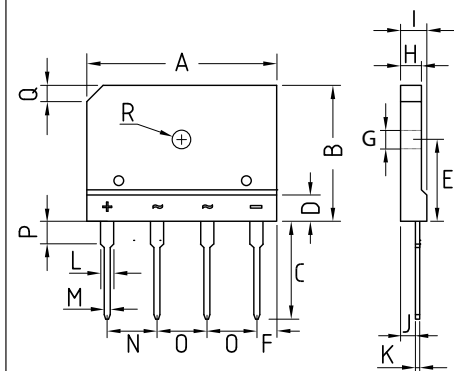

Dim.	Millimeter		Inches	
	min	max	min	max
A	29.70	30.30	1.170	1.194
B	19.70	20.30	0.776	0.800
C	17.00	18.00	0.670	0.709
D	4.70	4.90	0.185	0.193
E	10.80	11.20	0.426	0.441
F	2.30	2.70	0.091	0.106
G	3.10	3.40	0.122	0.134
H	3.40	3.80	0.134	0.150
I	4.40	4.80	0.173	0.189
J	2.50	2.90	0.099	0.114
K	0.60	0.80	0.024	0.032
L	2.00	2.40	0.079	0.095
M	0.90	1.10	0.035	0.043
N	9.80	10.20	0.386	0.402
O	7.30	7.70	0.288	0.303
P	3.80	4.20	0.150	0.165
Q	(3.0) x 45°		(0.118) x 45°	
Ø R	3.1	3.4	0.122	0.134

X025b GUPF

Weight = 8.5 g

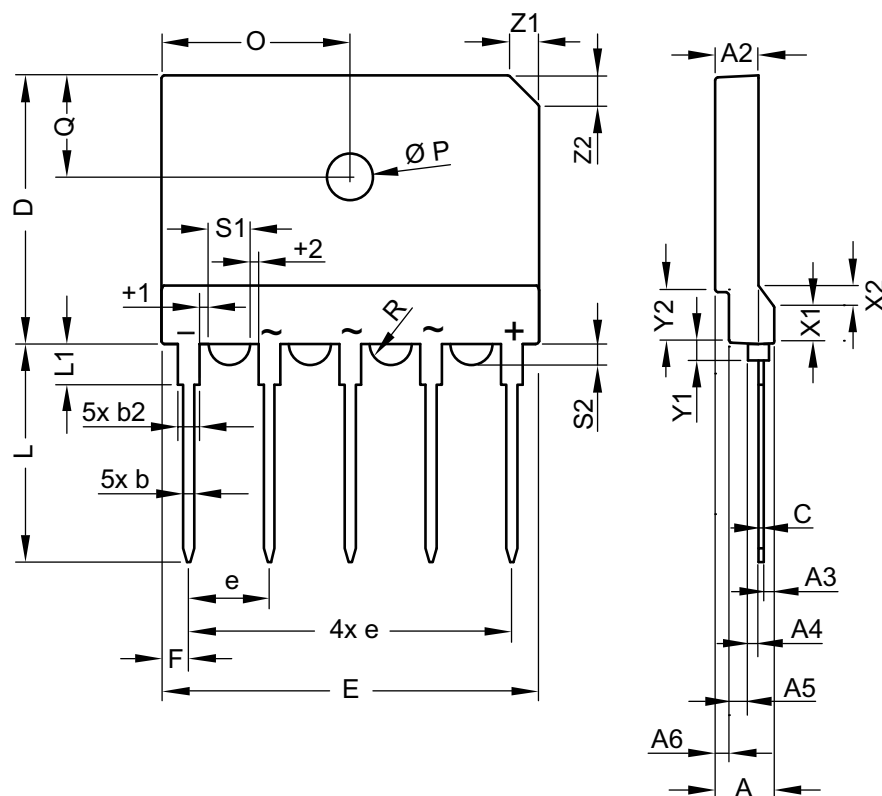

Dim.	Millimeter			Inches		
	min	typ.	max	min	typ.	max
A	5.40	5.50	5.60	0.213	0.217	0.221
A2	3.90	4.00	4.10	0.154	0.158	0.162
A3	0.95	1.00	1.10	0.037	0.039	0.043
A4	0.95	1.00	1.05	0.037	0.039	0.041
A5	1.60	1.70	1.80	0.063	0.067	0.071
A6	1.25	1.30	1.35	0.049	0.051	0.053
b	0.95	1.00	1.05	0.037	0.039	0.041
b2	1.95	2.00	2.05	0.077	0.079	0.081
C	0.45	0.50	0.55	0.018	0.020	0.022
D	24.80	25.00	25.20	0.977	0.985	0.993
E	34.70	35.00	35.30	1.367	1.379	1.391
e	BSC 7.50		BSC 0.296			
F	2.40	2.50	2.60	0.095	0.099	0.102
L	2.30	20.40	2.50	0.091	0.804	0.099
L1	3.70	3.75	3.80	0.146	0.148	0.150
O	17.40	17.50	17.60	0.686	0.690	0.693
Ø P	4.10	4.20	4.30	0.162	0.165	0.169
Q	9.20	9.30	9.40	0.362	0.366	0.370
½ R	-	1.77	-	-	0.070	-
s1	3.45	3.50	3.55	0.136	0.138	0.140
s2	1.45	1.50	1.55	0.057	0.059	0.061
t1	0.95	1.00	1.05	0.037	0.039	0.041
t2	0.95	1.00	1.05	0.037	0.039	0.041
x1	3.20	3.30	3.40	0.126	0.130	0.134
x2	1.90	2.00	2.10	0.075	0.079	0.083
y1	1.60	1.65	1.70	0.063	0.065	0.067
y2	4.65	4.70	4.75	0.183	0.185	0.187
z1	2.80	2.90	3.00	0.110	0.114	0.118

Dimensions in mm and inches (1 mm = 0.0394")

X026c ISOPLUS™-DIL (SMD) Weight = 13 g

X026d ISOPLUS™-DIL (SMD) Weight = 13 g

X027a SOT-227 B miniBLOC Weight = 29 g X027b SOT-227 UI miniBLOC

Dim.	Millimeter		Inches	
	min	max	min	max
A	31.50	31.88	1.240	1.255
B	7.80	8.20	0.307	0.323
C	4.09	4.29	0.161	0.169
D	4.09	4.29	0.161	0.169
E	4.09	4.29	0.161	0.169
F	14.91	15.11	0.587	0.595
G	30.12	30.30	1.186	1.193
H	37.80	38.23	1.488	1.505
J	11.68	12.22	0.460	0.481
K	8.92	9.60	0.351	0.378
L	0.74	0.84	0.029	0.033
M	12.50	13.10	0.492	0.516
N	25.15	25.42	0.990	1.001
O	1.95	2.13	0.077	0.084
P	4.95	6.20	0.195	0.244
Q	26.54	26.90	1.045	1.059
R	3.94	4.42	0.155	0.174
S	4.55	4.85	0.179	0.191
T	24.59	25.25	0.968	0.994
U	-0.05	0.10	-0.002	0.004
V	3.20	5.50	0.126	0.217
W	19.81	21.08	0.780	0.830
Z	2.50	2.70	0.098	0.106

X028 ISOPLUS227™ Weight = 19 g

Dim.	Millimeter		Inches	
	min	max	min	max
A	31.50	32.26	1.240	1.270
B	7.87	8.38	0.310	0.330
C	3.94	4.19	0.155	0.165
D	3.94	4.19	0.155	0.165
D1	3.81	3.98	0.150	0.157
E	4.06	4.27	0.160	0.168
F	14.91	15.11	0.587	0.595
G	30.12	30.30	1.186	1.193
H	37.80	38.23	1.489	1.505
J	11.81	12.22	0.465	0.481
K	9.40	9.65	0.370	0.380
L	0.76	0.84	0.030	0.033
M	12.60	12.85	0.496	0.506
N	25.15	25.42	0.990	1.001
O	2.54	2.64	0.100	0.105
P	4.95	5.97	0.195	0.235
Q	26.54	26.90	1.045	1.059
R	4.06	4.32	0.160	0.170
S	4.72	4.85	0.186	0.191
T	24.59	25.07	0.968	0.987
U	-0.03	0.05	-0.001	0.002
V	3.30	4.06	0.130	0.160
W	19.81	21.08	0.780	0.830
X	19.56	20.57	0.770	0.810
Y	17.27	18.29	0.680	0.720
Z	22.48	22.66	0.885	0.892

X030a SMPD-B Weight = 8.5 g

Notes:

- potrusion may add 0.2 mm max. on each side
- additional max. 0.05 mm per side by punching misalignment or overlap of dam bar or bending compression
- DCB area 10 to 50 µm convex; position of DCB area in relation to plastic rim: ±25 µm (measured 2 mm from Cu rim)
- terminal plating: 0.2 - 1 µm Ni + 10 - 25 µm Sn (gal v.) cutting edges may be partially free of plating

Dimensions in mm and inches (1 mm = 0.0394")

X031...* SMPD-X * See data sheet for pin arrangement Weight = 8.5 g*

Dim.	Millimeter		Inches	
	min	max	min	max
A	5.30	5.70	0.209	0.224
A1	3.90	4.10	0.154	0.161
A2	1.40	1.60	0.055	0.063
b	0.90	1.15	0.035	0.045
c	0.45	0.65	0.018	0.026
D	24.80	25.25	0.976	0.994
E	22.80	23.25	0.898	0.915
E1	13.80	14.20	0.543	0.559
e	2.00	BSC	0.079	BSC
e1	8.00	BSC	0.315	BSC
H	32.30	33.30	1.272	1.311
L	4.60	5.30	0.181	0.209
L1	1.30	1.70	0.051	0.067
L2	0.00	0.15	0.000	0.006
S	18.85	20.12	0.742	0.792
S1	1.45	2.08	0.057	0.082
T	20.90	22.17	0.823	0.873
T1	1.42	2.03	0.056	0.080
a	4°	-	4°	-

Note:
 1. Bottom heatsink meets 2.6 kV AC isolation to the other pins.
 2. All leads are matte pure tin plated.

X032... MiniSMPD * See data sheet for pin arrangement

Dim.	Millimeter		Inches	
	min	max	min	max
A	5.30	5.70	0.209	0.224
A1	3.90	4.10	0.154	0.161
A2	1.40	1.60	0.055	0.063
b	0.90	1.15	0.035	0.045
c	0.45	0.65	0.018	0.026
D	16.80	17.20	0.661	0.677
E	19.80	20.20	0.780	0.795
E1	10.80	11.20	0.425	0.441
e	2.00 BSC		0.079 BSC	
H	29.50	30.10	1.161	1.185
L	4.60	5.30	0.181	0.209
L1	1.30	1.70	0.051	0.067
L2	0.00	0.15	0.000	0.006
S	16.80	17.20	0.661	0.677
S1	1.30	1.70	0.051	0.067
T	13.80	14.20	0.543	0.559
T1	1.30	1.70	0.051	0.067

NOTE:
 1. All leads are matte pure tin plated.
 2. Cu surface of bottom DCB is pre-Ni plated unless otherwise.
 3. Cu surface of bottom DCB is electrically isolated 2.500V AC from all other leads.
 4. Unless other specified, pin out are as follows:
 Pin #1 - Gate
 Pin #3 - Gate return or source
 Pin #4 through #8 - Source (emitter)
 Pin #9 through #16 - Drain (collector)

Dimensions in mm and inches (1 mm = 0.0394")

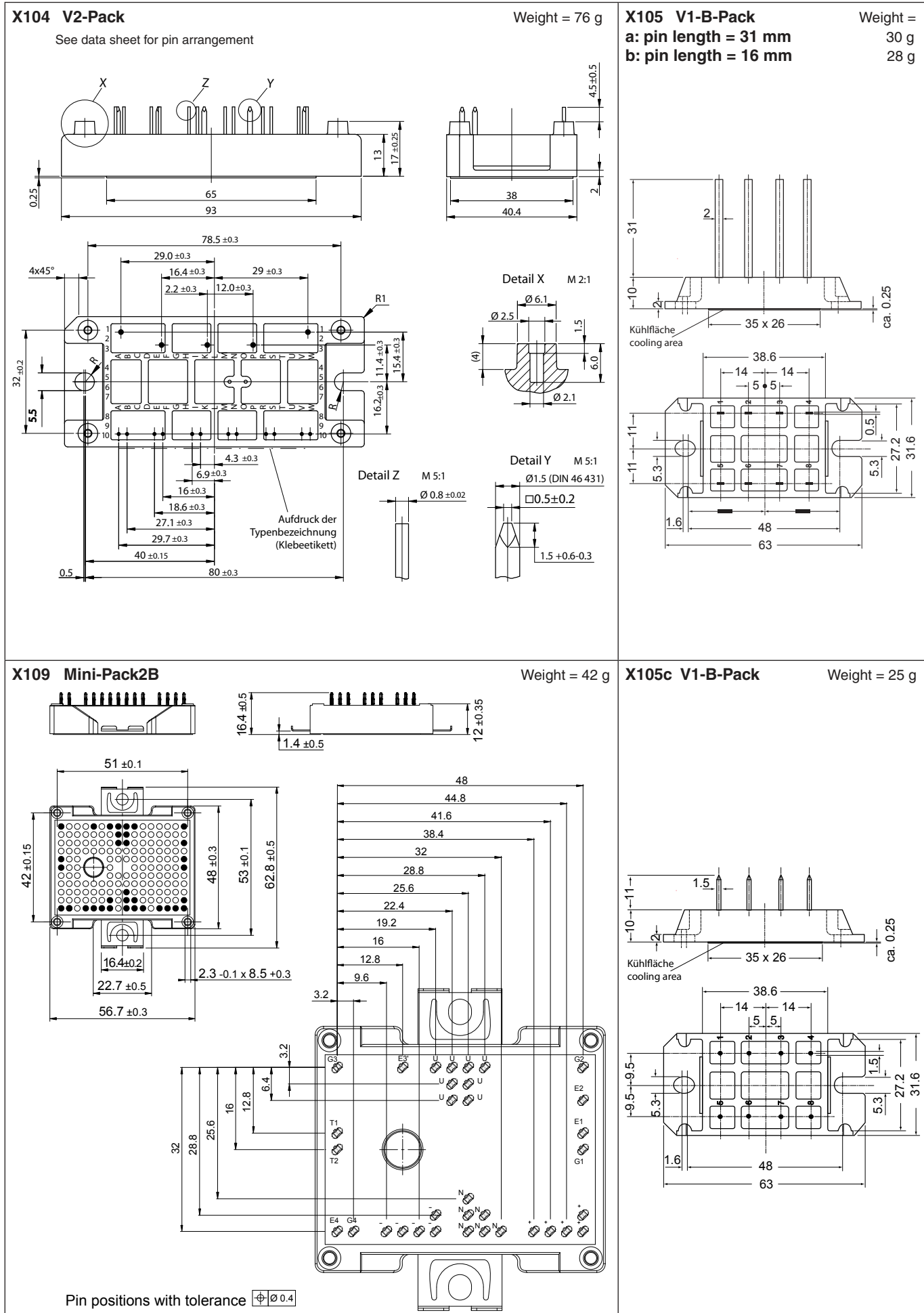

Dimensions in mm and inches (1 mm = 0.0394")

X111 E1-Pack

See data sheet for pin arrangement

Weight = 39 g

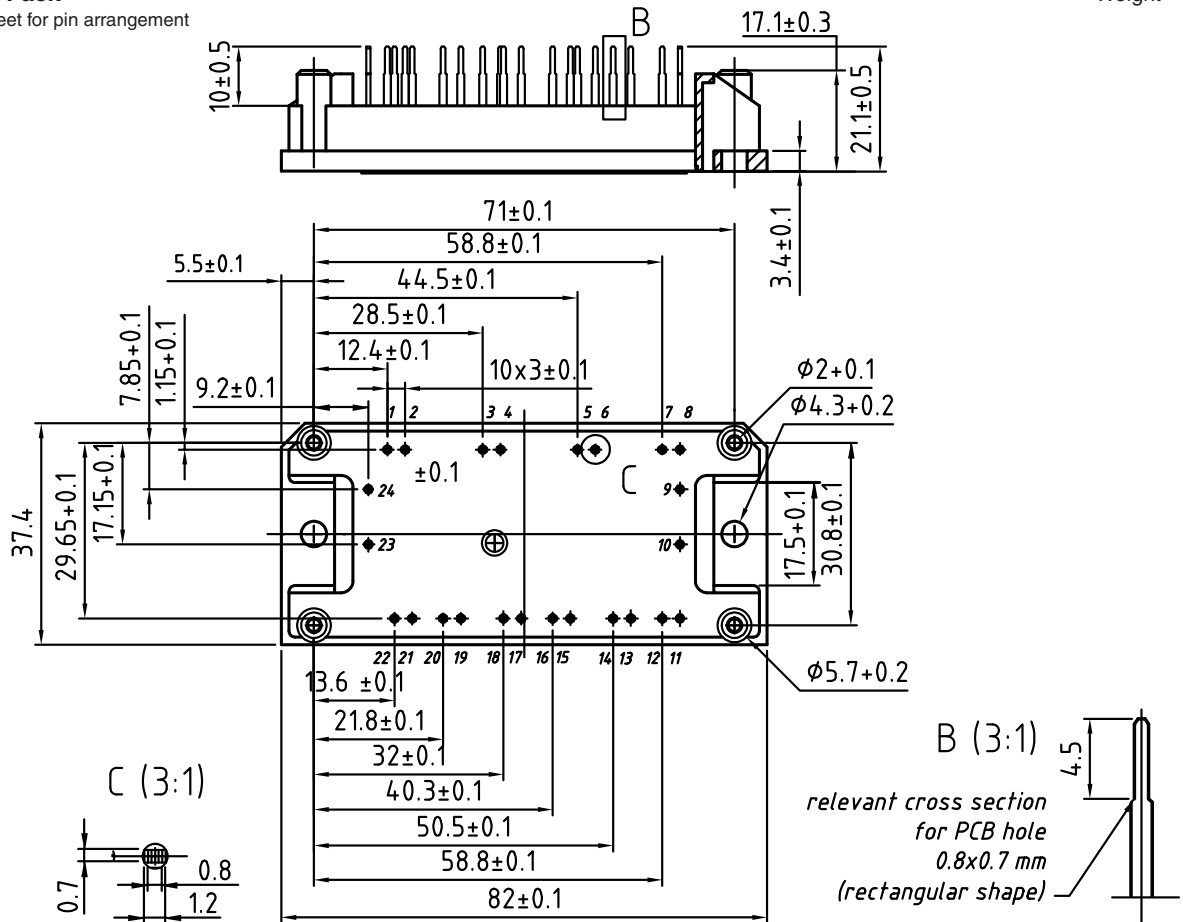

X112 E2-Pack

See data sheet for pin arrangement

Weight = 176 g

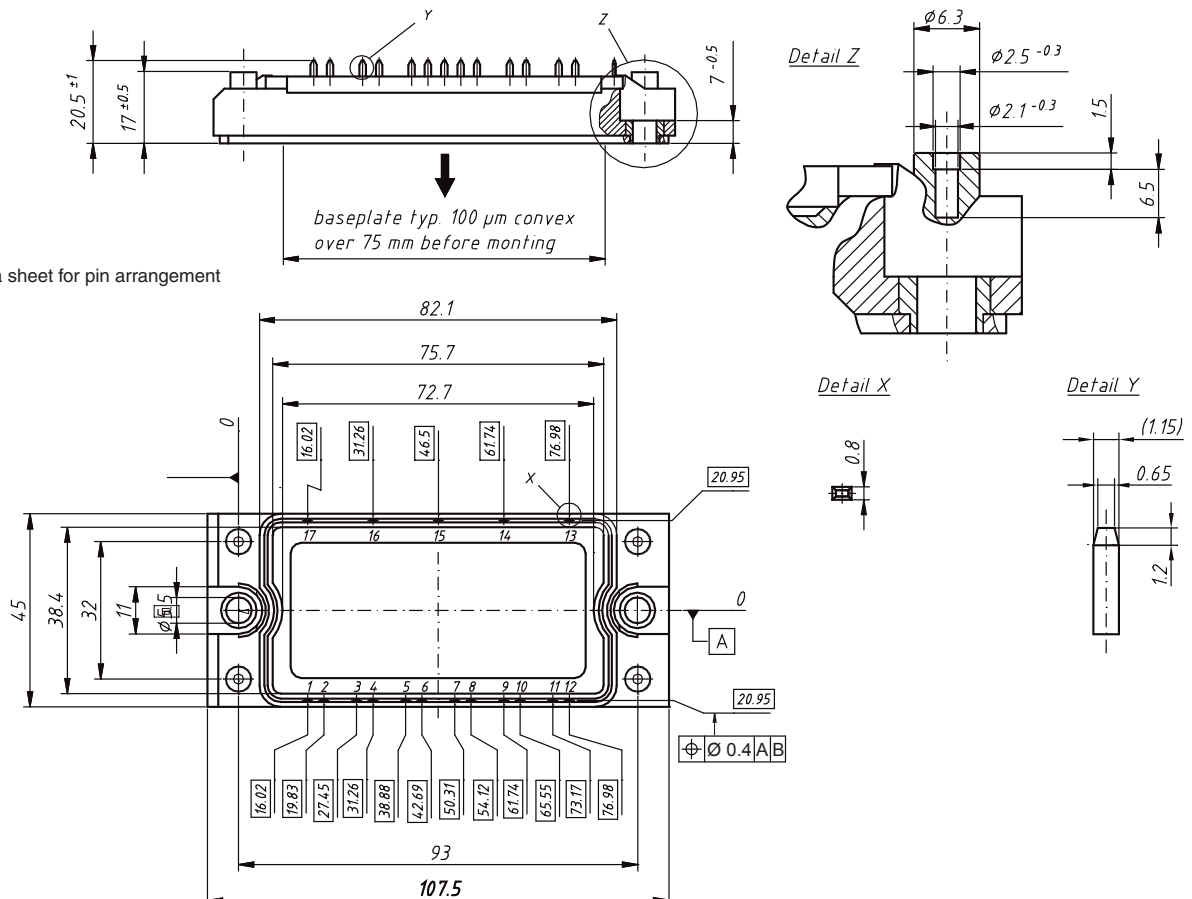

Dimensions in mm and inches (1 mm = 0.0394")

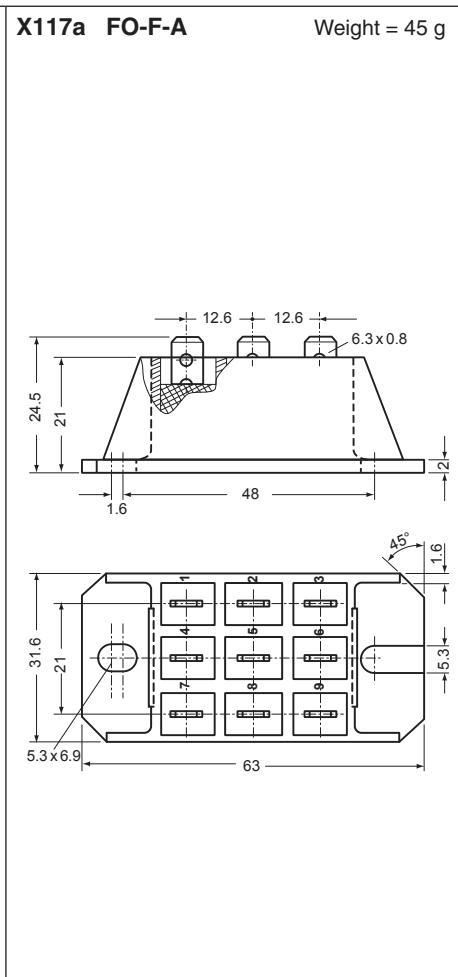
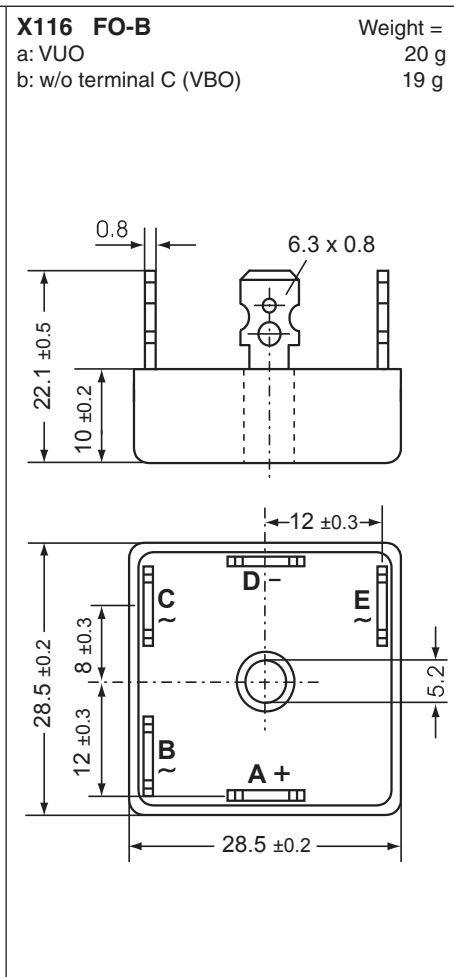
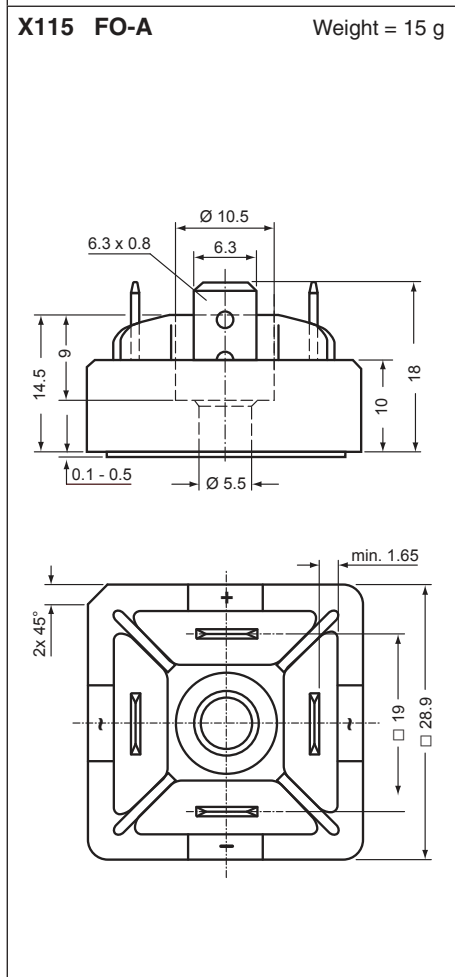
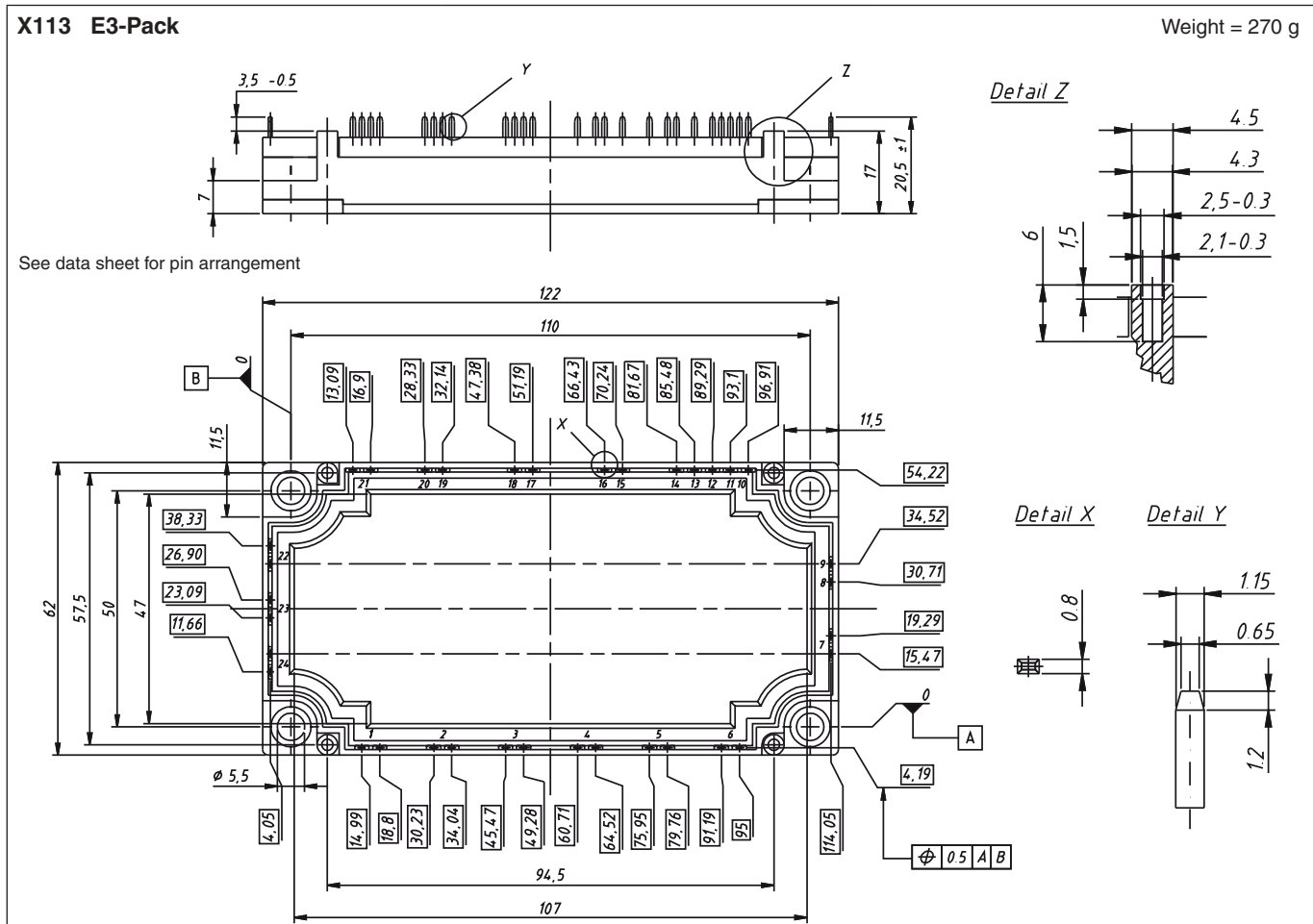

Dimensions in mm and inches (1 mm = 0.0394")

<p>X117b FO-F-B Weight = 45 g</p>	<p>X118 FO-T-A Weight = 104 g c: w/o terminal 4, 5, & 6 (VVZ & VVZF) d: w/o terminal 1, 2, 3, 4, 5, & 6 (VUO)</p> <p>See data sheet for pin arrangement</p>	
<p>X119 PWS-A Weight = a: VUO 104 g b: w/o terminal D (VBO) 100 g</p>	<p>X120 PWS-B Weight = a: VUO 203 g b: w/o terminal D (VBO) 193 g</p>	<p>X121 PWS-C Weight = a: VUO 250 g b: w/o terminal D (VBO) 237 g</p>

Dimensions in mm and inches (1 mm = 0.0394")

<p>X122 PWS-D Weight =</p> <p>a: VUO 159 g</p> <p>b: w/o terminal C (VBO) 153 g</p>	<p>X122 PWS-D Flat Weight =</p> <p>c: VUO 118 g</p> <p>Max. allowed screw-in depth: 6 mm</p>	<p>X123 PWS-E Weight =</p> <p>a: VTO 284 g</p> <p>b: w/o terminal 4, 5 & 6 (VVZ) 284 g</p> <p>c: w/o terminal 1, 2, 3, 4, 5 & 6 (VUO) 284 g</p> <p>d: w/o terminal D, 3, 4, 5 & 6 (VHF) 273 g</p> <p>e: w/o terminal D, 1, 2, 3, 4, 5 & 6 (VBO) 273 g</p>
<p>X123 PWS-E Flat Weight = 220 g</p> <p>h: w/o terminal 1, 2, 3, 4, 5 & 6 (VUO)</p> <p>Max. allowed screw-in depth: 7.2 mm</p>	<p>X125 TO-240 AA Weight =</p> <p>a: + Kelvin contact (MCC) 81 g</p> <p>b: + Kelvin contact, w/o pin 6 & 7 (MCD) 81 g</p> <p>c: w/o Kelvin contact 4 & 7 (MCC) 81 g</p> <p>d: w/o Kelvin contact 4, 7 & pin 6 (MCD) 81 g</p> <p>e: w/o pin 4, 5, 6 & 7 (MDD) 81 g</p> <p>f: w/o terminal 2 and pin 4 & 7 (VMO) 74 g</p> <p>g: + Kelvin contact, w/o pin 7 (VMM) 81 g</p> <p>A 2.8 - 0.8 DIN 46244</p> <p>General tolerance: DIN ISO 2768 class „c“</p> <p>Optional accessories: Keyed gate/cathode twin plugs Wire length: 350 mm, gate = white, cathode = red UL 758, style 3751 Type ZY 200L (L = Left for pin pair 4/5) Type ZY 200R (R = Right for pin pair 6/7)</p>	

Dimensions in mm and inches (1 mm = 0.0394")

<p>X126 Y4-M6 Weight = a: + Kelvin cont., w/o pin 8 up to 11 (MCC) 131 g b: + Kelvin cont., w/o pin 6 up to 11 (MCD) 131 g c: w/o pin 4 up to 11 (MDD) 126 g d: w/o terminal 2 & pin 4 up to 11 (MEO) 108 g</p> <p>Optional accessories for modules Keyed gate/cathode twin plugs with wire length = 350 mm, gate = white, cathode = red Type ZY 180L (L = Left for pin pair 4/5) } UL 758, style 3751 Type ZY 180R (R = Right for pin pair 6/7)</p>	<p>X127 Y4-M5 Weight = a: w/o pin 8 up to 11 (MII) 110 g b: w/o pin 6 up to 11 (MID) 108 g c: w/o pin 4, 5 & 8 up to 11 (MDI) 108 g</p> <p>General tolerances: DIN ISO 2768-T1-m</p>	<p>X128 Y3-DCB Weight = a: w/o pin 4 up to 7 (VMM, MII) 222 g b: w/o pin 4 up to 9 (MID) 220 g c: w/o pin 4 up to 7, 10 & 11 (MDI) 220 g d: w/o terminal 3 & pin 6 up to 11 (VMO) 200 g</p>
<p>X129 Y2-DCB Weight = a: + Kelvin contact (MCC) 245 g b: + Kelvin contact, w/o pin 6 & 7 (MCD) 245 g c: w/o pin 4, 5, 6 & 7 (MDD) 244 g</p>	<p>X130 Y3-Li Weight = a: w/o pin 4-7, low inductance (VMM, MII) 226 g b: w/o pin 4-9, low inductance (MID) 226 g c: w/o pin 4-7, 10&11, low inductance (MDI) 226 g d: w/o terminal 1&pin 6-11, low ind. (VMO) 206 g e: w/o pin 4&5, low ind. (VMM, MII+NTC) 226 g f: w/o pin 4, 5, 8 & 9, low ind. (MID+NTC) 226 g</p>	<p>X131 Y1-CU Weight = a: + Kelvin contact (MCC) 680 g b: + Kelvin contact, w/o pin 6&7 (MCD) 680 g c: w/o pin 4, 5, 6 & 7 (MDD) 680 g</p> <p>Optional accessories for modules Keyed gate/cathode twin plugs with wire length = 350 mm, gate = white, cathode = red Type ZY 180L (L = Left for pin pair 4/5) } UL 758, style 3751 Type ZY 180R (R = Right for pin pair 6/7)</p>

Dimensions in mm and inches (1 mm = 0.0394")

X132 Y1-2-CU

a: + Kelvin contact w/o pin 6&7 (MCO)
b: w/o pin 4, 5, 6 & 7 (MDO)

Weight = 650 g

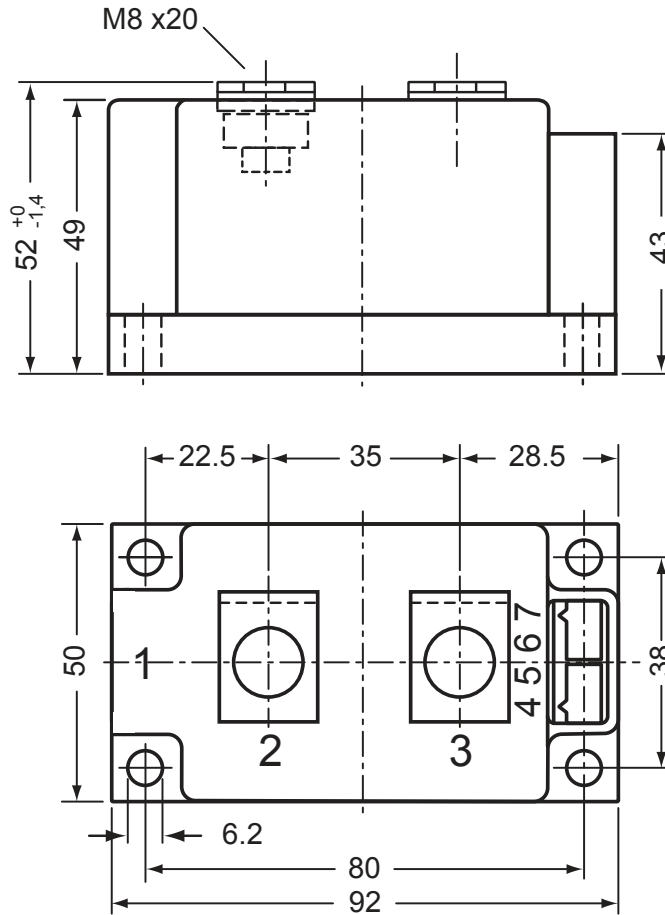

X141 SimBus A

a: + Kelvin contact (MCC)
b: + Kelvin contact, w/o pin 7 & 8 (MCD)
c: w/o pin 5, 6, 7 & 8 (MDD)

Weight = 152 g

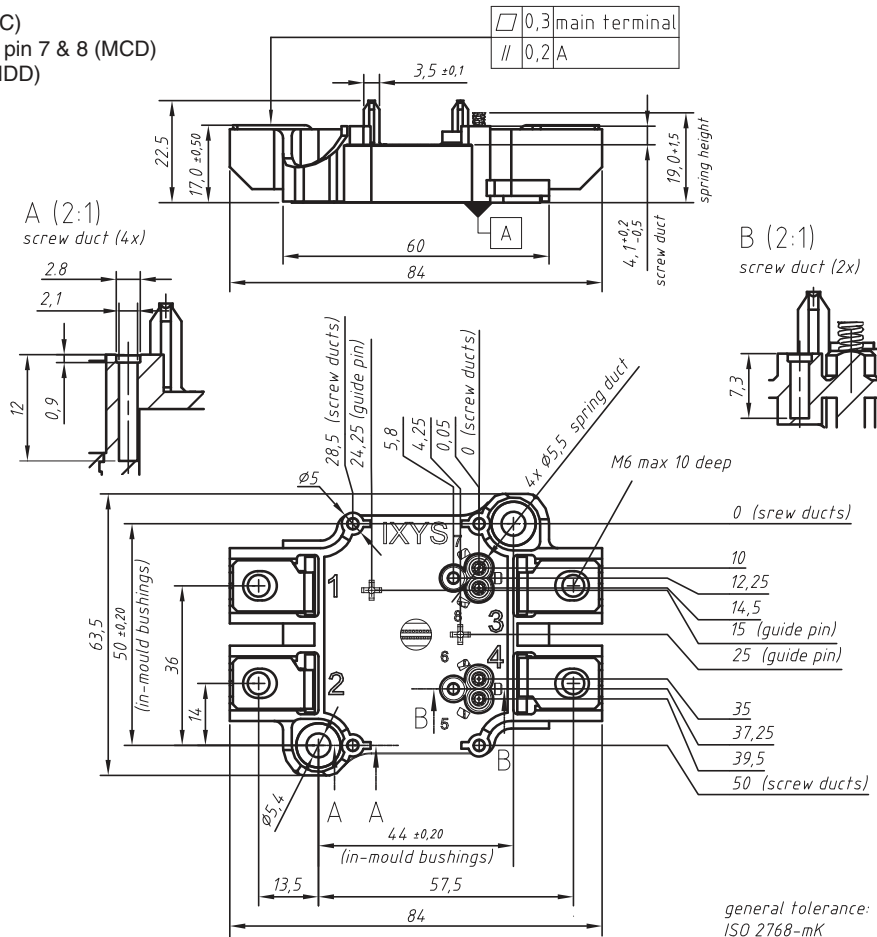

general tolerance:
ISO 2768-mK

Dimensions in mm and inches (1 mm = 0.0394")

X142 ComPack

Weight = 500 g

- a: + Kelvin contact (MCC)
- b: + Kelvin contact, w/o pin 6 & 7 (MCD)
- c: w/o pin 4, 5, 6 & 7 (MDD)

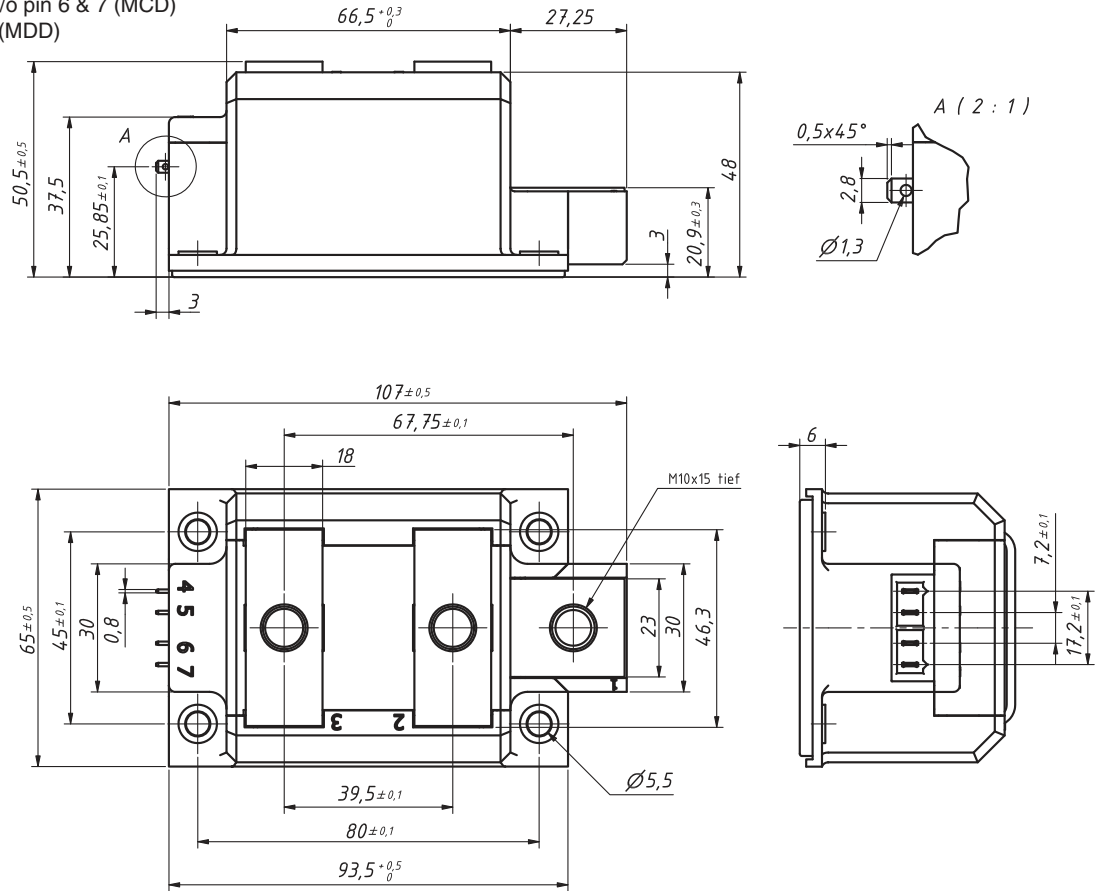

X143a SimBus F

Weight = 150 g

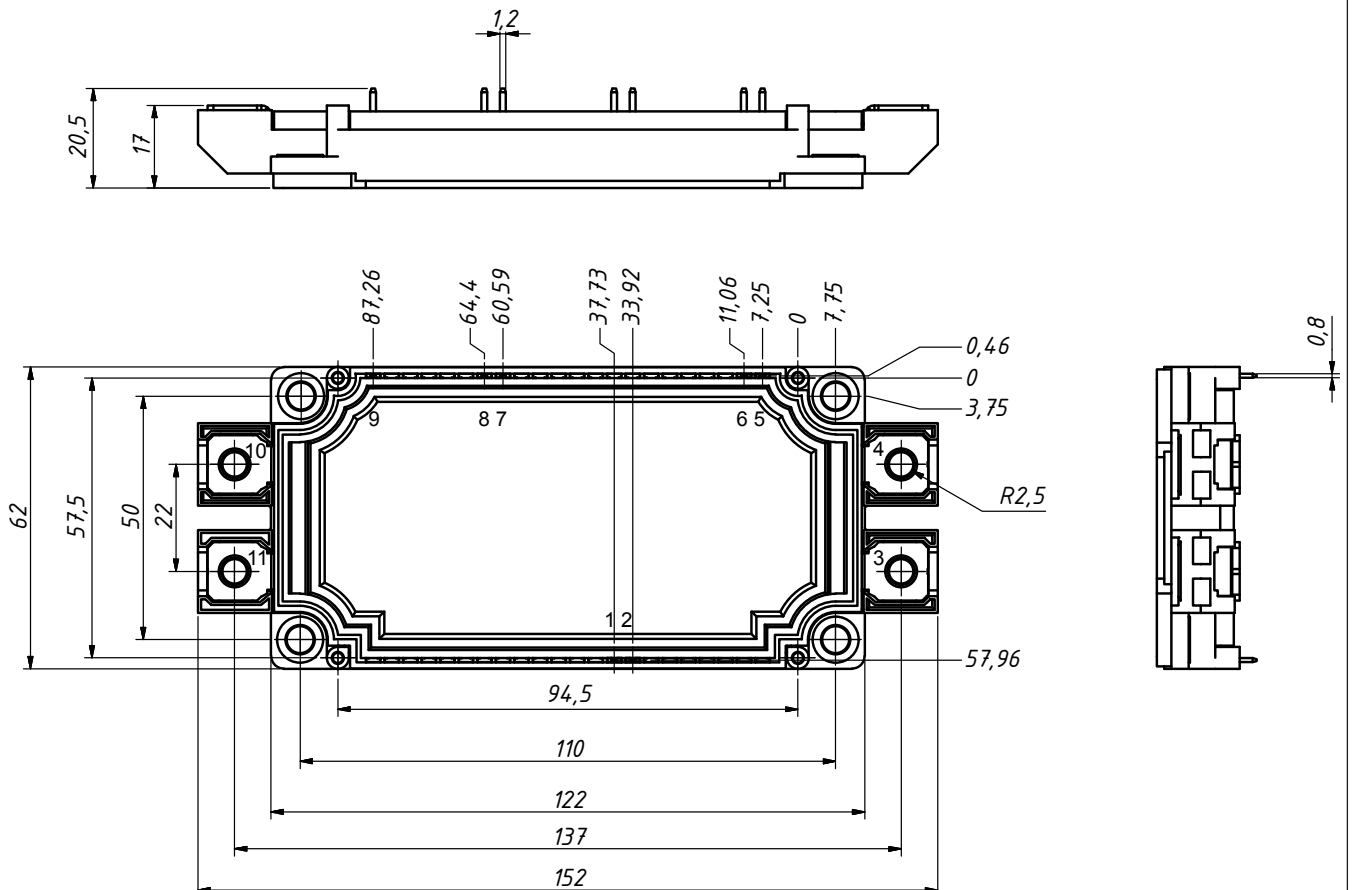

Dimensions in mm and inches (1 mm = 0.0394")

<p>X200 Metal-can Weight = 2.5 g</p>	<p>X201 FP-Case (oilproof) Weight = 0.9 g</p>	<p>X202 BOD-Package Weight = 9.5 g</p>
<p>X204 DO-203 AA [M] (DO-4) Weight = 6 g</p>	<p>X205 DO-203 AA [UNF] (DO-4) Weight = 5.5 g</p>	<p>X206a DO-203 AB [UNF] (DO-5) X206b DO-203 AB [M] (DO-5) Weight = 14 g</p>

Dimensions in mm and inches (1 mm = 0.0394")

<p>X207 DO-203 AB (DO-5) Weight = 20 g</p>	<p>X209 TO-208 AA (TO-48) Weight = 11.6 g</p>	<p>X210 TO-208 AC (TO-65) Weight = 21.7 g</p>																																																															
<p>X251 UGE-single Weight = 125 g</p>	<p>X252 UG Weight = 155 g</p>	<p>X253a UG Weight = 310 g b: w/o middle terminal</p>																																																															
<table border="1"> <thead> <tr> <th>Type</th> <th>a</th> <th>b</th> <th>c</th> <th>d</th> <th>e</th> <th>f</th> <th>g</th> <th>h</th> <th>i</th> <th>k</th> </tr> </thead> <tbody> <tr> <td>UGB 3132 AD</td> <td>80</td> <td>70</td> <td>57</td> <td>58.5</td> <td>260</td> <td>6</td> <td>15</td> <td>15</td> <td>15</td> <td></td> </tr> <tr> <td>UGB 6124 AG</td> <td>135</td> <td>125</td> <td>112</td> <td>58.5</td> <td>260</td> <td>11</td> <td>32.5</td> <td>25</td> <td>32.5</td> <td></td> </tr> <tr> <td>UGD 6123 AG</td> <td>135</td> <td>125</td> <td>112</td> <td>58.5</td> <td>260</td> <td>8</td> <td>30</td> <td>18</td> <td>18</td> <td>30</td> </tr> <tr> <td>UGD 8124 AG</td> <td>135</td> <td>125</td> <td>112</td> <td>58.5</td> <td>260</td> <td>8</td> <td>30</td> <td>18</td> <td>18</td> <td>30</td> </tr> </tbody> </table>											Type	a	b	c	d	e	f	g	h	i	k	UGB 3132 AD	80	70	57	58.5	260	6	15	15	15		UGB 6124 AG	135	125	112	58.5	260	11	32.5	25	32.5		UGD 6123 AG	135	125	112	58.5	260	8	30	18	18	30	UGD 8124 AG	135	125	112	58.5	260	8	30	18	18	30
Type	a	b	c	d	e	f	g	h	i	k																																																							
UGB 3132 AD	80	70	57	58.5	260	6	15	15	15																																																								
UGB 6124 AG	135	125	112	58.5	260	11	32.5	25	32.5																																																								
UGD 6123 AG	135	125	112	58.5	260	8	30	18	18	30																																																							
UGD 8124 AG	135	125	112	58.5	260	8	30	18	18	30																																																							
<p>Dimensions in mm</p>																																																																	

Dimensions in mm and inches (1 mm = 0.0394")

