



Parameter	Rating	Units
Open Circuit Voltage, Typical	5.5	V
Short Circuit Current, Typical	2.5	$\mu\text{A}$
Input Control Current	5	mA

### Features

- Optically Isolated, Input to Output
- Dual Independent, Floating Outputs for Parallel, Series, or Isolated Configuration
- 5mA Control Current
- May Be Configured for AC and DC Switching
- Replacement of Discrete Components
- No EMI/RFI Generation
- Surface Mount and Tape & Reel Version Available
- Flammability Rating UL 94 V-0

### Applications

- MOSFET Driver
- Programmable Control
- Process Control
- Instrumentation
- Telecommunications

### Description

The FDA215 is a dual photovoltaic MOSFET driver. Each independent driver consists of an LED that is optically coupled to a photodiode array.

The driver output is controlled by means of the highly effective infrared LED at the input. When the input current is applied to the LED, the light emitted activates the photodiode array, and generates the voltage at the output.

The photodiode array is capable of generating a floating power source with voltage and current sufficient to drive high-power MOSFET transistors. Each photodiode array contains an integrated turn-off circuit that discharges the external MOSFET gate when LED current is removed. This eliminates the need to use external components to facilitate the discharge. The optically coupled technology provides 3750V<sub>rms</sub> of input to output isolation.

The FDA215 is well suited for use in discrete solid state relay designs and in other isolated switching applications.

### Approvals

- EN 62368-1 Certificate# B 082667 0008

### Ordering Information

Part #	Description
FDA215	8-Pin DIP (50/tube)
FDA215S	8-Pin Surface Mount (50/tube)
FDA215STR	8-Pin Surface Mount (1000/reel)

### Pin Configuration

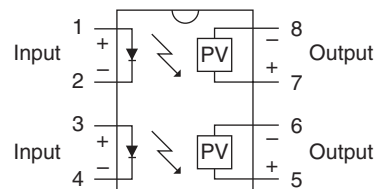

**Absolute Maximum Ratings @ 25°C**

Parameter	Ratings	Units
Reverse Input Voltage	5	V
Input Control Current Peak (10ms)	100	mA
	1	A
Input Power Dissipation <sup>1</sup>	150	mW
Total Power Dissipation <sup>2</sup>	500	mW
Isolation Voltage, Input to Output	3750	V <sub>rms</sub>
Operational Temperature	-40 to +85	°C
Storage Temperature	-40 to +125	°C

Absolute Maximum Ratings are stress ratings. Stresses in excess of these ratings can cause permanent damage to the device. Functional operation of the device at conditions beyond those indicated in the operational sections of this data sheet is not implied.

Typical values are characteristic of the device at +25°C, and are the result of engineering evaluations. They are provided for information purposes only, and are not part of the manufacturing testing requirements.

<sup>1</sup> Derate linearly 1.33 mW / °C

<sup>2</sup> Derate output power linearly 6.67 mW / °C

**Electrical Characteristics @ 25°C**

Parameter	Conditions	Symbol	Min	Typ	Max	Units
<b>Output Characteristics</b>						
Open Circuit Voltage	I <sub>F</sub> =5mA	V <sub>OC</sub>	3	5.5	8	V
Short Circuit Current	I <sub>F</sub> =5mA	I <sub>SC</sub>	1	2.5	9	μA
	I <sub>F</sub> =25mA		2.5	3.5	20	
Switching Speeds	I <sub>F</sub> =5mA, C <sub>LOAD</sub> =200pF	t <sub>on</sub>	-	-	5	ms
Turn-On			t <sub>off</sub>	-	-	
Turn-Off						
Offstate Clamping Resistance	V <sub>L</sub> =1V	R <sub>CL</sub>	100	250	3300	Ω
<b>Input Characteristics</b>						
LED Current to Activate	-	I <sub>F</sub>	-	-	5	mA
Input Voltage Drop	I <sub>F</sub> =5mA	V <sub>F</sub>	0.9	1.2	1.5	V
Reverse Input Current	V <sub>R</sub> =5V	I <sub>R</sub>	-	-	10	μA
<b>Common Characteristics</b>						
Capacitance, Input to Output	V <sub>IO</sub> =0V, f=1MHz	C <sub>IO</sub>	-	3	-	pF

**PERFORMANCE DATA**

**LED Forward Voltage vs. Forward Current (Room Temperature)**

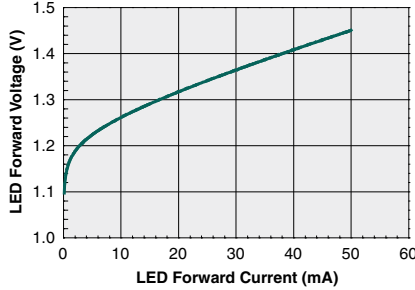

**Turn-On Time vs. Capacitance ( $V_{OUT}=5V$ )**

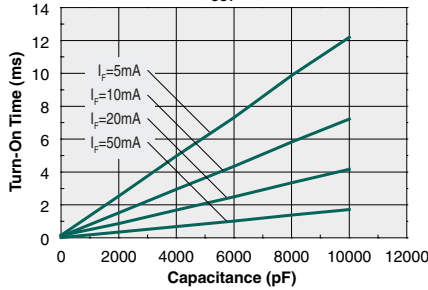

**Turn-Off Time vs. Capacitance ( $V_{OUT}=1V$ )**

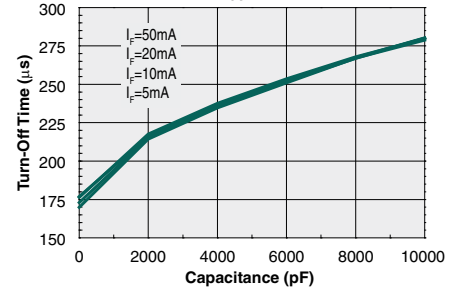

**LED Forward Voltage vs. Temperature**

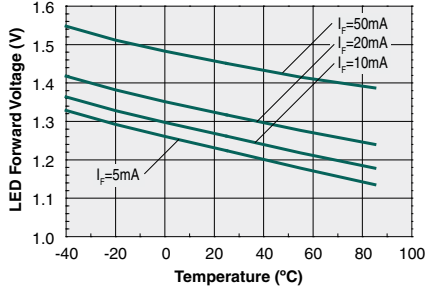

**Turn-On Time vs. LED Current ( $V_{OUT}=5V, C=200pF$ )**

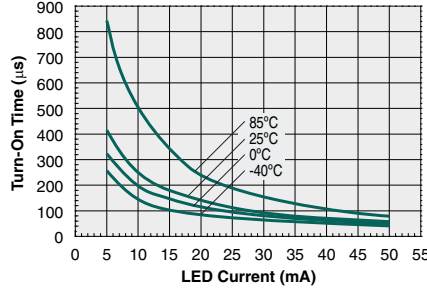

**Turn-Off Time vs. LED Current ( $V_{OUT}=1V, C=200pF$ )**

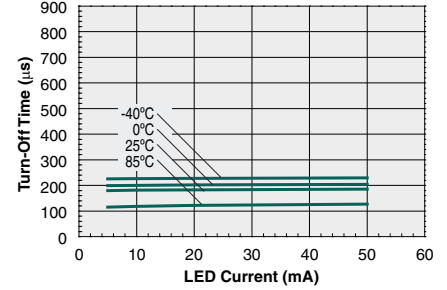

**Offstate Output Resistance vs. Temperature ( $V_{LOAD}=1V$ , Internal to Photovoltaic Driver)**

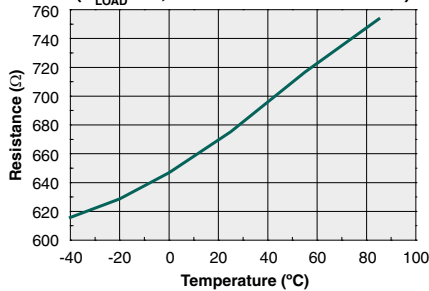

**Turn-On Time vs. Temperature ( $V_{OUT}=5V, C_{OUT}=200pF$ )**

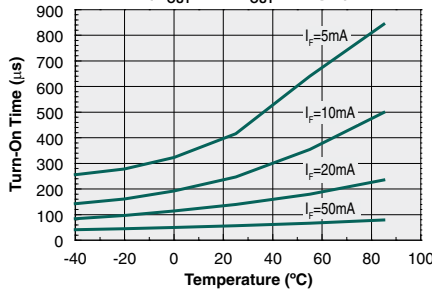

**Turn-Off Time vs. Temperature ( $V_{OUT}=1V, C_{OUT}=200pF$ )**

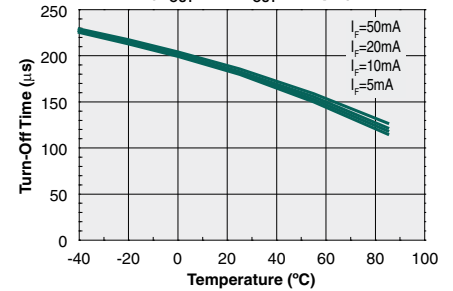

**Open Circuit Voltage vs. Temperature**

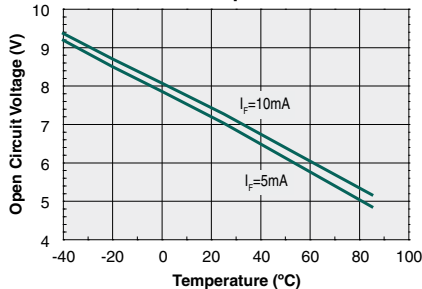

**Short Circuit Current vs. Temperature**

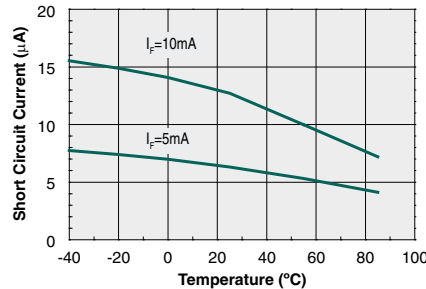

**Output Current vs. Output Voltage**

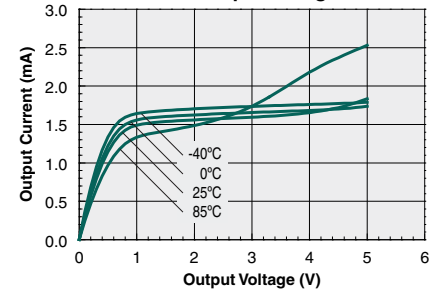

\*Unless otherwise noted, data presented in these graphs is typical of device operation at 25°C.

## Manufacturing Information

### Moisture Sensitivity



All plastic encapsulated semiconductor packages are susceptible to moisture ingress. IXYS Integrated Circuits classifies its plastic encapsulated devices for moisture sensitivity according to the latest version of the joint industry standard, **IPC/JEDEC J-STD-020**, in force at the time of product evaluation. We test all of our products to the maximum conditions set forth in the standard, and guarantee proper operation of our devices when handled according to the limitations and information in that standard as well as to any limitations set forth in the information or standards referenced below.

Failure to adhere to the warnings or limitations as established by the listed specifications could result in reduced product performance, reduction of operable life, and/or reduction of overall reliability.

This product carries a **Moisture Sensitivity Level (MSL)** classification as shown below, and should be handled according to the requirements of the latest version of the joint industry standard **IPC/JEDEC J-STD-033**.

Device	Moisture Sensitivity Level (MSL) Classification
FDA215S	MSL 1

### ESD Sensitivity



This product is ESD Sensitive, and should be handled according to the industry standard **JESD-625**.

### Soldering Profile

Provided in the table below is the **IPC/JEDEC J-STD-020** Classification Temperature ( $T_C$ ) and the maximum dwell time the body temperature of these surface mount devices may be ( $T_C - 5$ )°C or greater. The Classification Temperature sets the Maximum Body Temperature allowed for these devices during reflow soldering processes.

Device	Classification Temperature ( $T_C$ )	Dwell Time ( $t_p$ )	Max Reflow Cycles
FDA215S	250°C	30 seconds	3

For through-hole devices, the wave soldering maximum lead (pin) temperature and the maximum dwell time the leads (pins) are at the peak soldering temperature is given in the table below. Maximum wave soldering parameters are shown below.

Device	Pin Temperature	Body Temperature	Dwell Time	Wave Cycles
FDA215	260°C	250°C	10 seconds	1

### Board Wash

IXYS Integrated Circuits recommends the use of no-clean flux formulations. Board washing to reduce or remove flux residue following the solder reflow process is acceptable provided proper precautions are taken to prevent damage to the device. These precautions include but are not limited to: using a low pressure wash and providing a follow up bake cycle sufficient to remove any moisture trapped within the device due to the washing process. Due to the variability of the wash parameters used to clean the board, determination of the bake temperature and duration necessary to remove the moisture trapped within the package is the responsibility of the user (assembler). Cleaning or drying methods that employ ultrasonic energy may damage the device and should not be used. Additionally, the device must not be exposed to halide flux or solvents.



**MECHANICAL DIMENSIONS**

**FDA215S**

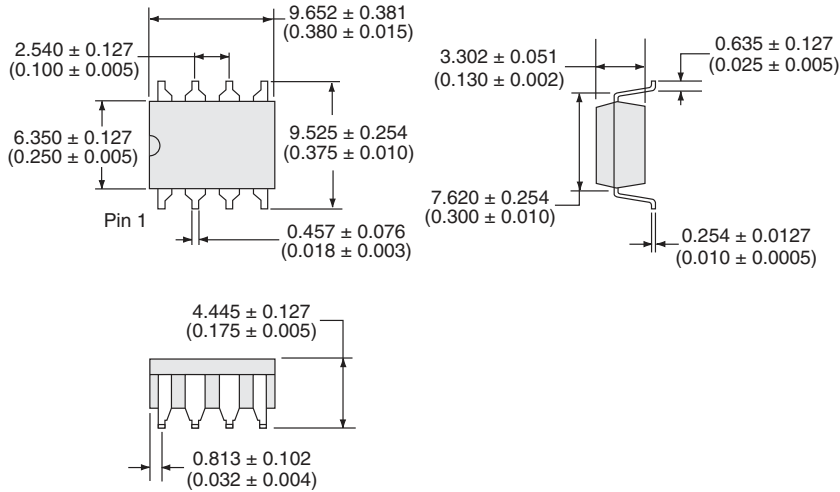

**PCB Land Pattern**

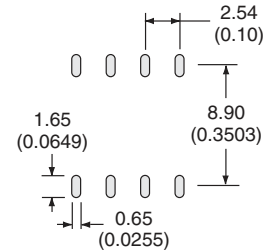

Dimensions  
mm  
(inches)

**FDA215STR Tape & Reel**

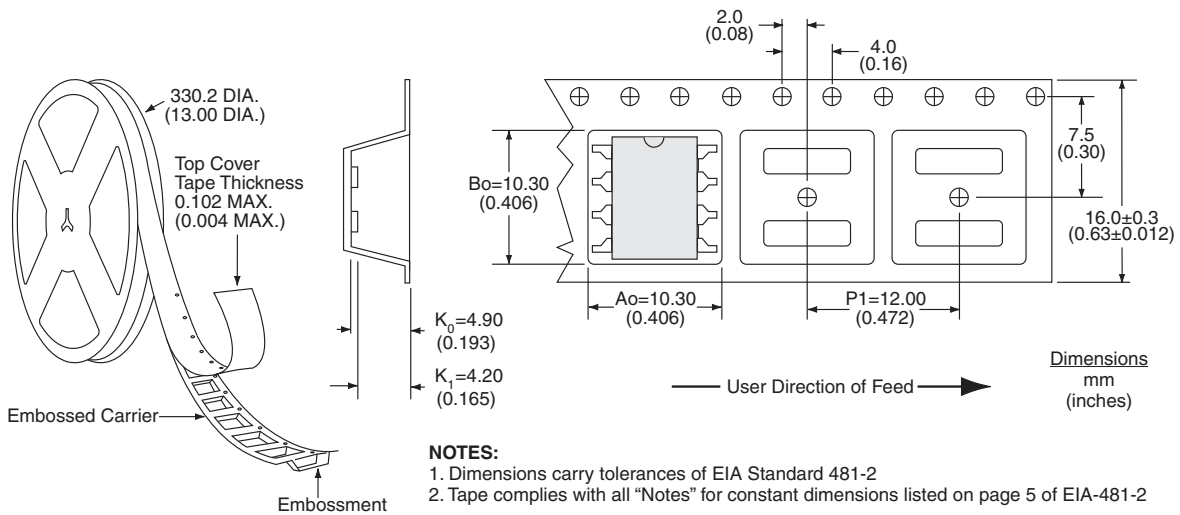

FDA215

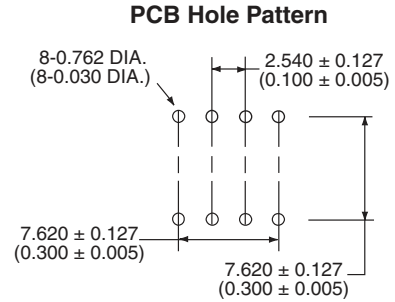
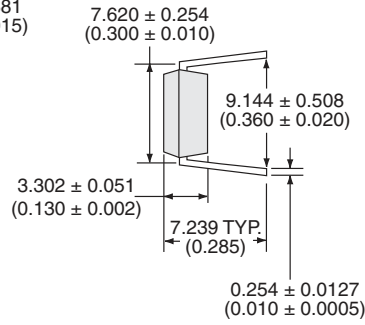
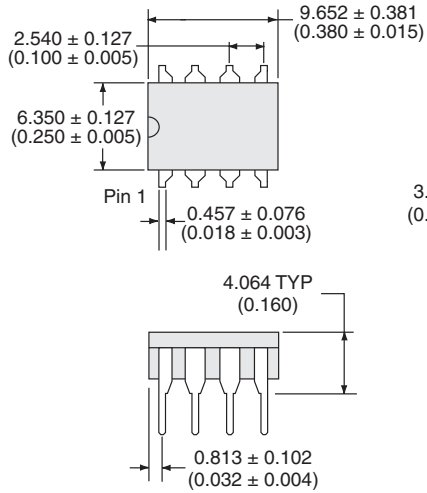

Dimensions  
mm  
(inches)

For additional information please visit our website at: <https://www.ixysic.com>



Disclaimer Notice - Information furnished is believed to be accurate and reliable. However, users should independently evaluate the suitability of and test each product selected for their own applications. Littelfuse products are not designed for, and may not be used in, all applications. Read complete Disclaimer Notice at <https://www.littelfuse.com/disclaimer-electronics>.

Specification: DS-FDA215-R08  
 ©Copyright 2022, Littelfuse, Inc.  
 All rights reserved. Printed in USA.  
 5/12/2022