

206038-4 ✓ ACTIVE

AMP | AMP CPC

TE Internal #: 206038-4

Circular Power Connectors, Housing, 250 VDC, Wire-to-Panel, 28  
Position, Wire & Cable, Receptacle, Reverse Gender, Socket,  
Signal, Black, AMP CPC

[View on TE.com >](#)



[Connectors](#) > [Power Connectors](#) > [Circular Power](#) > [Circular Power Connectors](#) > [CPC Connectors, Series 2](#)



Connector Product Type: **Housing**

Operating Voltage: **250 VDC**

Connector System: **Wire-to-Panel**

Number of Positions: **28**

Sealable: **No**

[All CPC Connectors, Series 2 \(23\)](#)

## Features

### Product Type Features

Connector Product Type	Housing
Connector System	Wire-to-Panel
Sealable	No
Connector & Contact Terminates To	Wire & Cable
Connector & Housing Type	Receptacle
Circular Connector Shell Type	All Plastic

### Configuration Features

Reverse Numbering	Without
Number of Positions	28
Number of Power Positions	0
Number of Signal Positions	28

### Electrical Characteristics



Operating Voltage	250 VAC
-------------------	---------

### Contact Features

Reverse Gender	Yes
Contact Type	Socket
Contact Current Rating (Max)	7.5 A
Contact Protection	With

### Mechanical Attachment

Mating Alignment Type	Keyed
Mating Alignment	With
Panel Mount Feature Type	Flange with Threaded Inserts
Mating Retention Type	Threaded Coupling
Thread Size	15/16-20 UNEF – 2A
Connector Mounting Type	Panel Mount
Mating Retention	With
Panel Mount Feature	With

### Housing Features

Body Orientation	Straight
Housing Color	Black
Housing Material	Thermoplastic
Circular Connector Shell Size	17

### Dimensions

Compatible Insulation Diameter Range	1.73 mm [.068 in]
--------------------------------------	-------------------

### Usage Conditions

Operating Temperature Range	-55 – 105 °C [-67 – 221 °F]
Fluid Resistance	None

### Operation/Application

Circuit Application	Signal
Shielded	No

### Industry Standards

UL Flammability Rating	UL 94V-0
------------------------	----------

### Packaging Features

Packaging Quantity	100
--------------------	-----



Packaging Method

Bag

### Product Compliance

[For compliance documentation, visit the product page on TE.com>](#)

EU RoHS Directive 2011/65/EU

Compliant with Exemptions

EU ELV Directive 2000/53/EC

Compliant with Exemptions

China RoHS 2 Directive MIIT Order No 32, 2016

Restricted Materials Above Threshold

EU REACH Regulation (EC) No. 1907/2006

Current ECHA Candidate List: JUNE 2023 (235)

Candidate List Declared Against: JUNE 2023 (235)

SVHC > Threshold:

Pb (3.7% in Component Part)

**Article Safe Usage Statements:**

Do not eat, drink or smoke when using this product. Wash thoroughly after handling. Recycle if possible and dispose of the article by following all applicable governmental regulations relevant to your geographic location.

Halogen Content

BFR/CFR/PVC Free, but Br/Cl >900 ppm in other sources.

Solder Process Capability

Not applicable for solder process capability

**Product Compliance Disclaimer**

This information is provided based on reasonable inquiry of our suppliers and represents our current actual knowledge based on the information they provided. This information is subject to change. The part numbers that TE has identified as EU RoHS compliant have a maximum concentration of 0.1% by weight in homogenous materials for lead, hexavalent chromium, mercury, PBB, PBDE, DBP, BBP, DEHP, DIBP, and 0.01% for cadmium, or qualify for an exemption to these limits as defined in the Annexes of Directive 2011/65/EU (RoHS2). Finished electrical and electronic equipment products will be CE marked as required by Directive 2011/65/EU. Components may not be CE marked. Additionally, the part numbers that TE has identified as EU ELV compliant have a maximum concentration of 0.1% by weight in homogenous materials for lead, hexavalent chromium, and mercury, and 0.01% for cadmium, or qualify for an exemption to these limits as defined in the Annexes of Directive 2000/53/EC (ELV). Regarding the REACH Regulation, the information TE provides on SVHC in articles for this part number is based on the latest European Chemicals Agency (ECHA) 'Guidance on requirements for substances in articles' posted at this URL: <https://echa.europa.eu/guidance-documents/guidance-on-reach>

### Compatible Parts



TE Part # 206039-1  
CPC PLUG ASSEMBLY SIZE 17-28



TE Part # 207299-3  
FLANGE PLUG MOUNT CPC



TE Part # CAT-AM71-C83998B  
CPC Cable Clamps



TE Part # 213810-1  
CPC COUPLING RING SIZE 17



Also in the Series | AMP CPC

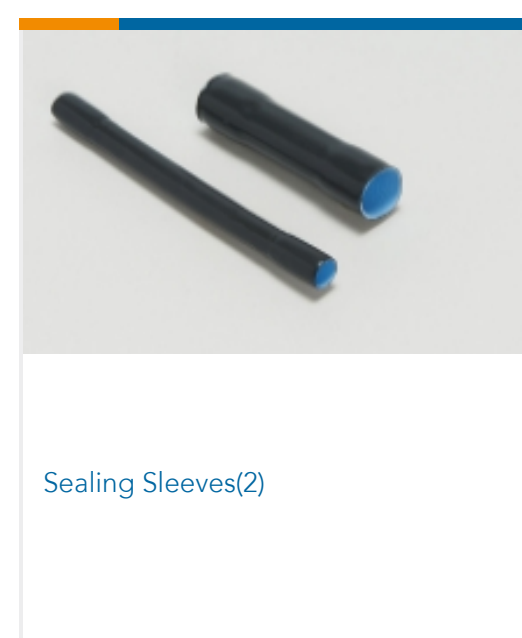
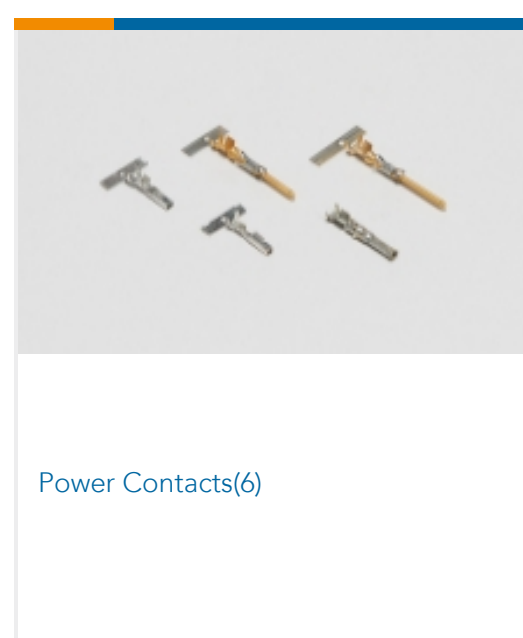
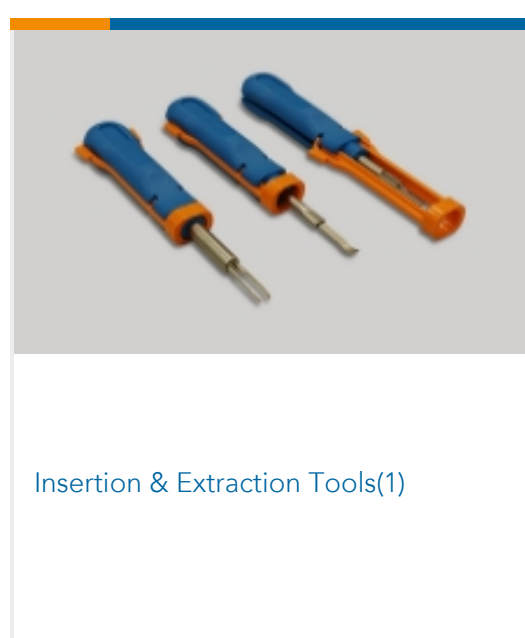
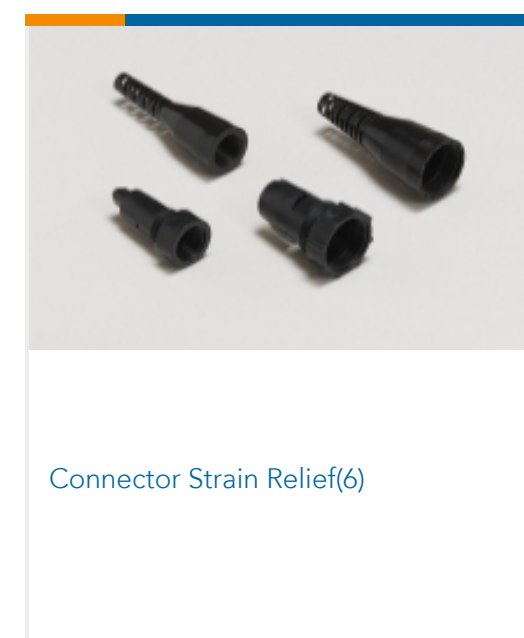
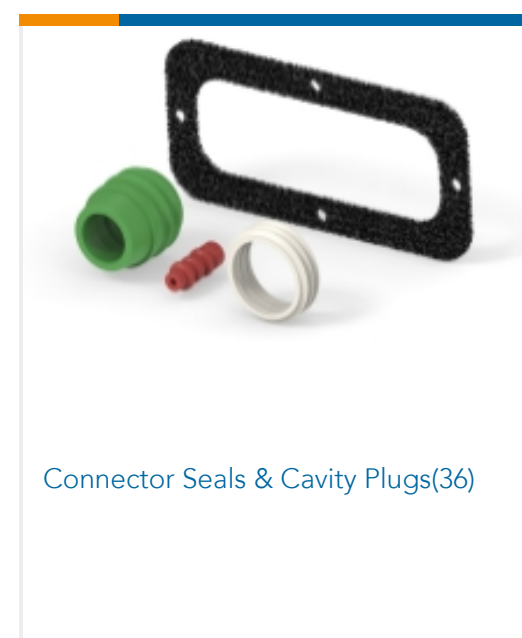
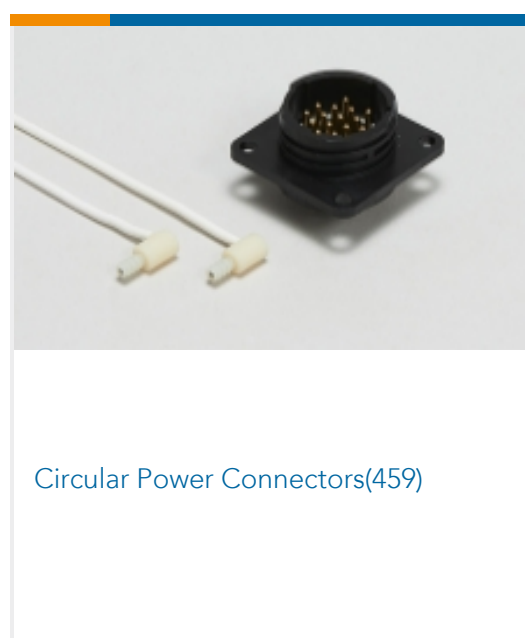
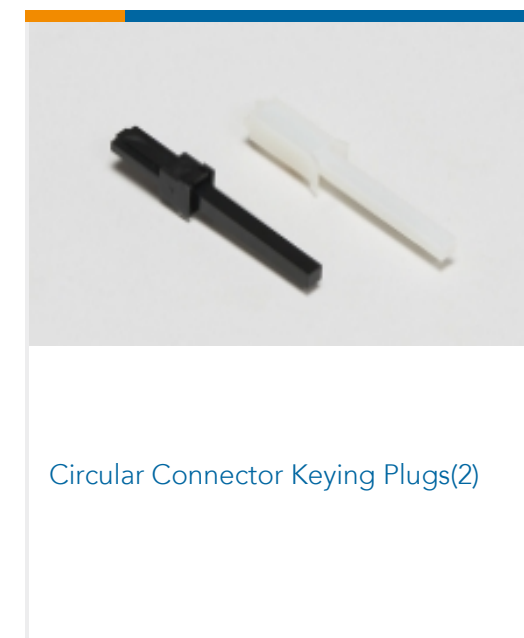
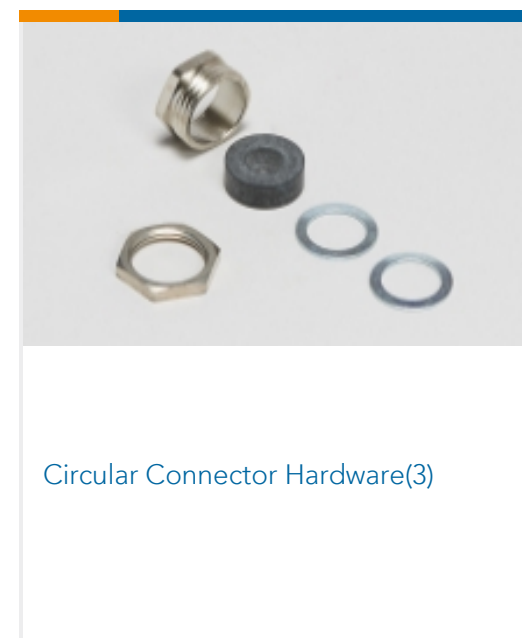
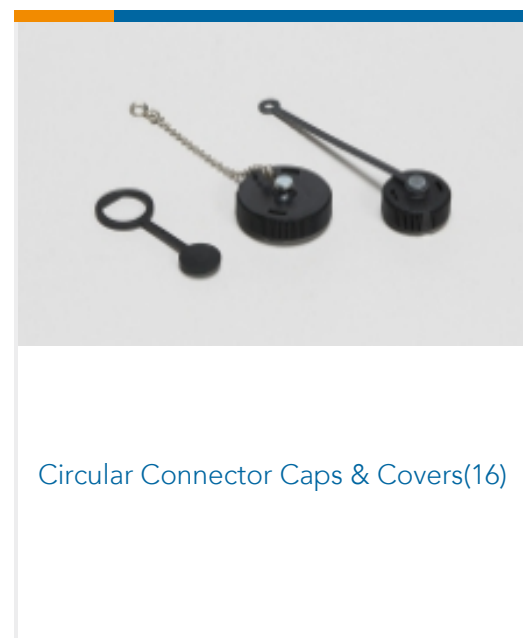
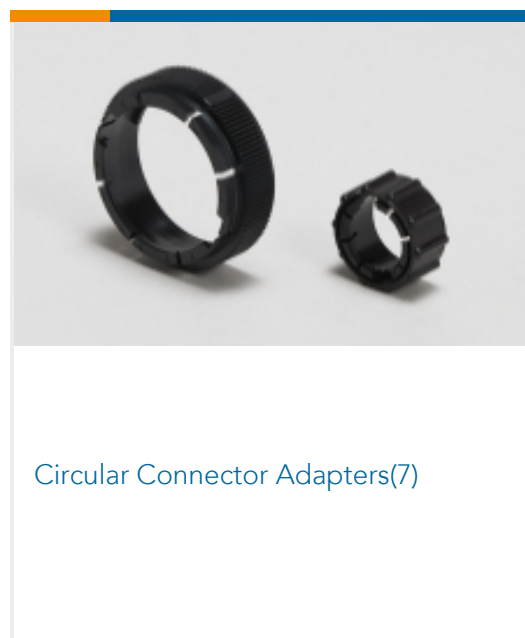

Customers Also Bought

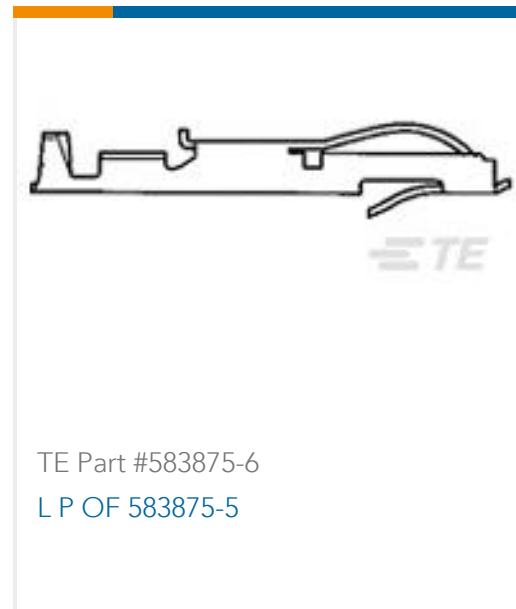

## Documents

### Product Drawings

CPC RECPT ASSEMBLY SIZE 17-28

English

### CAD Files

Customer View Model

[ENG\\_CVM\\_206038-4\\_H.2d\\_dxf.zip](#)

English

Customer View Model

[ENG\\_CVM\\_206038-4\\_H.3d\\_igs.zip](#)

English

Customer View Model

[ENG\\_CVM\\_206038-4\\_H.3d\\_stp.zip](#)

English

[3D PDF](#)

English

[3D PDF](#)

3D



**Customer View Model**

[ENG\\_CVM\\_CVM\\_206038-4\\_R.2d\\_dxf.zip](#)

English

**Customer View Model**

[ENG\\_CVM\\_CVM\\_206038-4\\_R.3d\\_igs.zip](#)

English

**Customer View Model**

[ENG\\_CVM\\_CVM\\_206038-4\\_R.3d\\_stp.zip](#)

English

By downloading the CAD file I accept and agree to the [Terms and Conditions](#) of use.

---

**Datasheets & Catalog Pages**

[AMP Circular Connectors for Commercial Signal & Power Applications](#)

English

---

**Product Specifications**

[Connector, Circular Plastic](#)

English

[Product Specification](#)

English

---

**Product Environmental Compliance**

[Product Compliance](#)

English

[Product Compliance](#)

English

---

**Agency Approvals**

[CSA Certificate](#)

English

[CSA Certificate](#)

English