



FEATURES:

- Super wide 10:1 Input range
- Extremely High Input range up to 1500VDC
- Continuous Short Circuit protection
- Over current and Over Voltage protection
- High I/O Isolation of 4000VAC
- High efficiency of up to 78%
- Under Voltage Input protection
- Reversed connection protection



Models
Dual output

Model	Input Voltage (V)	Output Voltage (V)	Output Current max (A)	Isolation (VAC)	Max Capacitive Load (uF)	Efficiency (%)		
						200 VDC	850 VDC	1400 VDC
AM45W-8501515D-NST	150-1500	15/15	1.53/1.53	4000	1500/470	78	78	76

NOTE: All specifications in this datasheet are measured at an ambient temperature of 25°C, humidity<75%, nominal input voltage and at rated output load unless otherwise specified.

Input Specifications

Parameters	Nominal	Typical	Maximum	Units
Voltage range	850VDC		150-1500	VDC
Input Current	200 VDC	350		mA
	300 VDC	230		
	850 VDC	90		
	1500 VDC	50		
Inrush current <2ms	200 VDC	30		A
	300 VDC	40		
	850 VDC	100		
	1500 VDC	180		
External fuse	15A/1500VDC			
Input Under voltage lockout		125-140		VDC
Absolute Maximum rating			1600	VDC
Peak Input Voltage time			1	s
Startup time*	Full input range, full load	2		s

* Cooling time between the power OFF and the next power ON should be over 15s.

Isolation Specifications

Parameters	Conditions	Typical	Maximum	Units
Tested I/O voltage	1 min, ≤10mA	4000		VAC
Isolation Voltage I/GND & O/GND	1 min, ≤10mA	2500		VAC
Isolation Voltage OUT 1/OUT 2	1 min, ≤10mA	4000		VAC

Output Specifications

Parameters	Conditions	Typical	Maximum	Units
Voltage accuracy		±1		%
Line voltage regulation	LL-HL	±1		% of Vin
Load voltage regulation	10-100% load	±2		%
Over voltage protection			25	VDC
Over current protection	Hiccup, Auto recovery		110-300	% of Iout
Short Circuit protection		Continuous, hiccup		
Short circuit restart		Auto recovery		
Temperature coefficient		±0.02		%/°C
Ripple & Noise	20MHz Bandwidth		150	mV p-p
Hold up time	300VDC Input	5		ms
	8500VDC Input	15		

General Specifications

Parameters	Conditions	Typical	Maximum	Units
Switching frequency	100% load	65		KHz
Operating temperature	See derating curve		-40 to 85	°C
Storage Temperature			-40 to 85	°C
Maximum case temperature			95	°C
Cooling	Free air convection			
Humidity			95	% RH
Altitude			5000	m
Case material	Metal			
Weight		520		g
Dimensions (L x W x H)	5.69 x 4.13 x 1.57 inches, 144.50 x 105.00 x 40.00 mm			
MTBF	>300,000 hrs (MIL-HDBK -217F, Ground Benign, t=+25°C)			

Safety Specifications

Parameters		
Standards	EMI - Conducted and radiated emission	EN55022, class A (with the recommended EMC circuit), EN55024: 2010
	Electrostatic Discharge Immunity	IEC 61000-4-2: Contact ±6KV/Air ±8KV, Criteria B
	RF, Electromagnetic Field Immunity	IEC 61000-4-3: 10V/m, Criteria A
	Electrical Fast Transient/Burst Immunity	IEC 61000-4-4: ±4KV, Criteria B
	Surge Immunity	IEC 61000-4-5: ±2KV, line to ground ±4KV Criteria B
	RF, Conducted Disturbance Immunity	IEC 61000-4-6: 10Vrms, Criteria A, (with the recommended EMC circuit)
	Voltage dips, Short Interruptions Immunity	IEC 61000-4-11: 0-70%, Criteria B

Pin Out Specifications

Pin	Function
1	-Vin
2	+Vin
3	Ground
4	-Vout 2
5	+Vout 2
6	-Vout 1
7	+Vout 1

Dimensions:

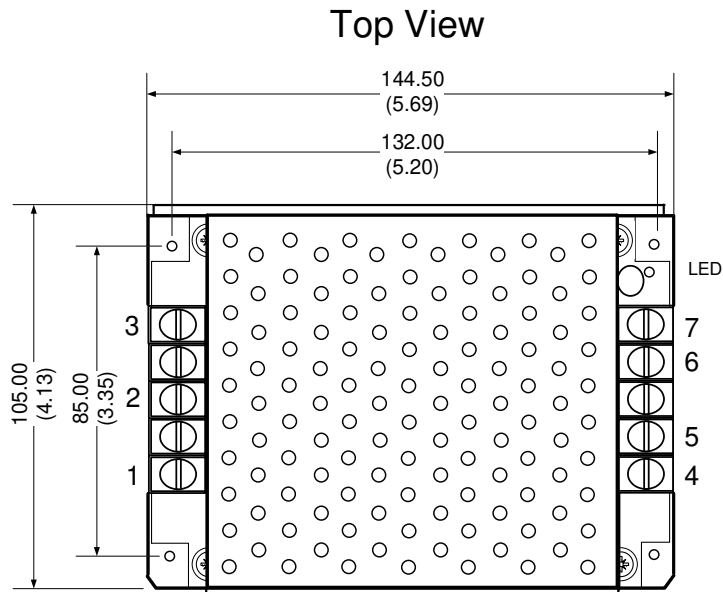

Side View

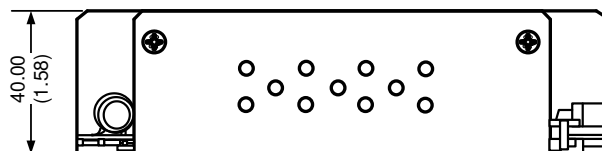

Dimensions: mm (inches)
Case Tolerance: ±1.00 (±0.04)
Torque: Max 0.4 N m
Wire wage: 22-12 AWG, 4mm²

Derating

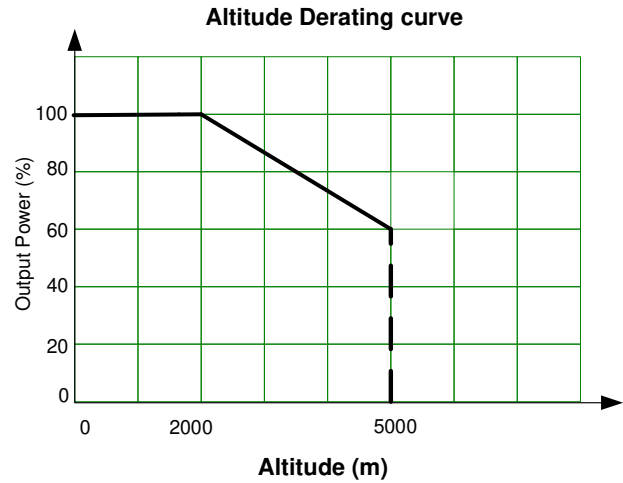
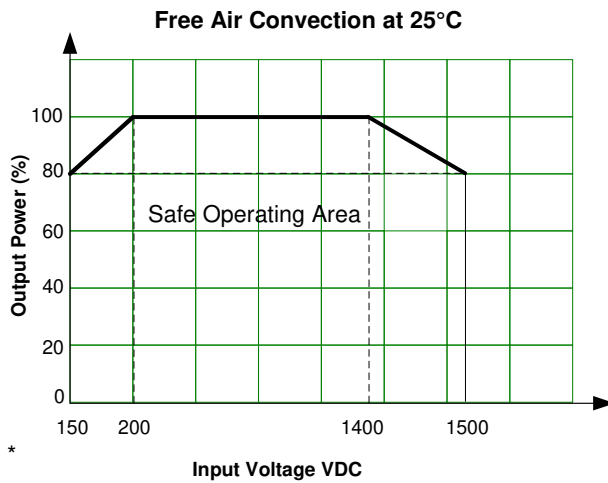
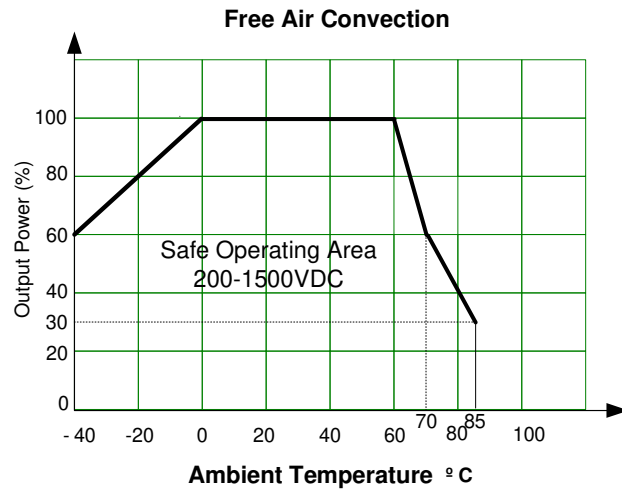
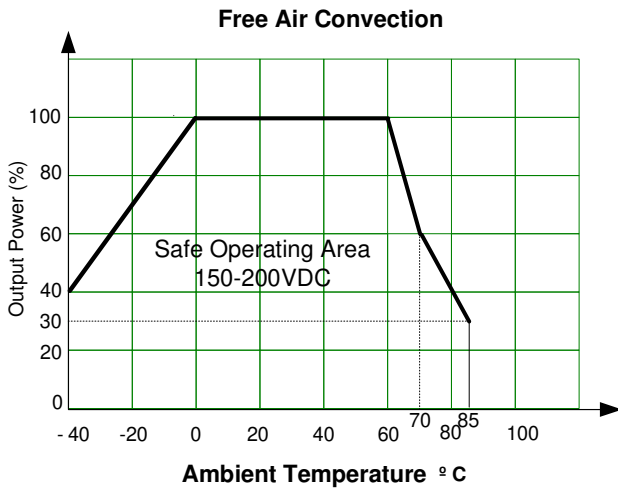

NOTE: Derating is indicated at natural convection. Sufficient air space around is needed.

Typical Application circuit

Dual Output

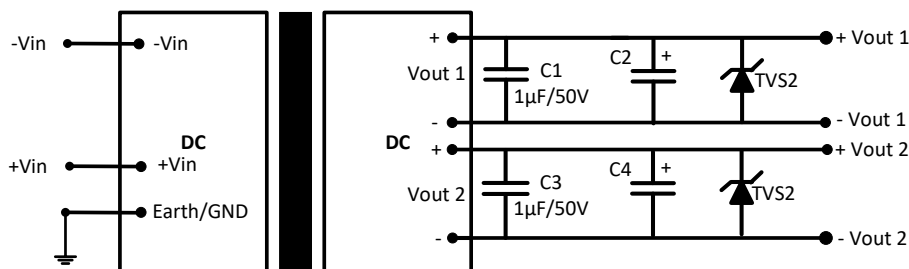

C2, C4	TVS1, TVS2
100 μF / 35V	20V

Recommended EMC Circuit

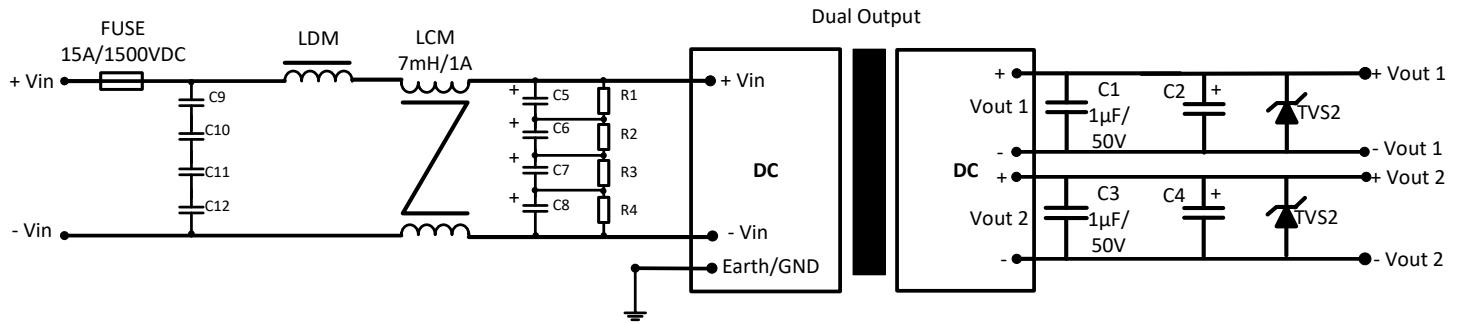

LDM	C2, C4	R1, R2, R3, R4	C5, C6, C7, C8	C9, C10, C11, C12	TVS1, TVS2
330 μH/0.38A	100 μF / 35V	1MΩ / 2W	47 μF / 450VDC	100 nF / 275VAC	20V

NOTE: 1. Datasheets are updated as needed and as such, specifications are subject to change without notice. Once printed or downloaded, datasheets are no longer controlled by Aimtec; refer to www.aimtec.com for the most current product specifications. 2. Product labels shown, including safety agency certifications on labels, may vary based on the date manufactured. 3. Mechanical drawings and specifications are for reference only. 4. All specifications are measured at an ambient temperature of 25°C, humidity<75%, nominal input voltage and at rated output load unless otherwise specified. 5. Aimtec may not have conducted destructive testing or chemical analysis on all internal components and chemicals at the time of publishing this document. CAS numbers and other limited information are considered proprietary and may not be available for release. 6. This product is not designed for use in critical life support systems, equipment used in hazardous environments, nuclear control systems or other such applications which necessitate specific safety and regulatory standards other the ones listed in this datasheet. 7. Warranty is in accordance with Aimtec's standard Terms of Sale available at www.aimtec.com.