

VC-MP-S3

Order No.: 1884746

The illustration shows versions, powder-coated and EMC-coated box mounting base

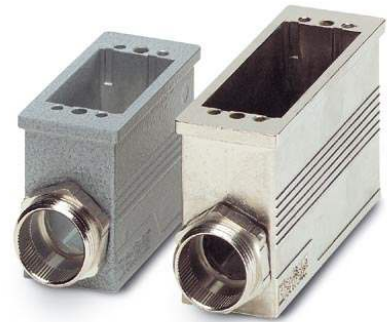

<http://eshop.phoenixcontact.de/phoenix/treeViewClick.do?UID=1884746>

Box mounting base, made of metal, powder-coated type 3, number of modules 4, cable screw connection Pg21

Commercial data	
EAN	4017918164775
Pack	5 pcs.
Customs tariff	85389099
Weight/Piece	0.52136 KG
Catalog page information	Page 371 (PC-2009)

Product notes

WEEE/RoHS-compliant since:
11/08/2006



<http://www.download.phoenixcontact.com>
Please note that the data given here has been taken from the online catalog. For comprehensive information and data, please refer to the user documentation. The General Terms and Conditions of Use apply to Internet downloads.

Technical data

General characteristics

Note	When using fiber optics, the bending radii of the cable manufacturers must be observed.
Design	VC3
Degree of protection	IP65/IP66/IP67
Type of the screw connection	Pg21
Pg screw connection	None

Height	58 mm
Number of module slots	4
Housing material	Zinc die-cast
Housing surface material	Powder coating
Seal material	EPDM
Ambient temperature (operation)	-40 °C ... 125 °C

Accessories

Item	Designation	Description
General		
1885619	VC-M-KV-PG21 1X6/2X9	Multiple screw connection Pg21, made of metal, consisting of rubber seal with several holes (1 x 6 mm/2 x 9 mm) and a pressure screw, for cable screw connection support VC-M-KV-PG21...
1885635	VC-M-KV-PG21 2X6/2X8	Multiple screw connection Pg21, made of metal, consisting of rubber seal with several holes (2 x 6 mm/2 x 8 mm) and a pressure screw, for cable screw connection support VC-M-KV-PG21...
1885648	VC-M-KV-PG21 2X7,2/1X10,5	Multiple screw connection Pg21, made of metal, consisting of rubber seal with several holes (2 x 7.2 mm/1 x 10.5 mm) and a pressure screw, for cable screw connection thread VC-M-KV-PG21...
1885651	VC-M-KV-PG21 3X7	Multiple screw connection Pg21, made of metal, consisting of rubber seal with several holes (3 x 7 mm) and a pressure screw, for cable screw connection thread VC-M-KV-PG21...
1885664	VC-M-KV-PG21 3X9	Multiple screw connection Pg21, made of metal, consisting of rubber seal with several holes (3 x 8 mm) and a pressure screw, for cable screw connection support VC-M-KV-PG21...
1885677	VC-M-KV-PG21 4X6,5	Multiple screw connection Pg21, made of metal, consisting of rubber seal with several holes (4 x 6.5 mm) and a pressure screw, for cable screw connection support VC-M-KV-PG21...
1885680	VC-M-KV-PG21 4X8	Multiple screw connection Pg21, made of metal, consisting of rubber seal with several holes (4 x 8 mm) and a pressure screw, for cable screw connection support VC-M-KV-PG21...
1853997	VC-M-KV-PG21(7-10,5)	Half screw connection Pg21, made of metal, consisting of rubber seal with one hole and one pressure screw, for type 2 - 4 housings, cable [mm] 7 - 10.5
1854006	VC-M-KV-PG21(9-13)	Half screw connection Pg21, made of metal, consisting of rubber seal with one hole and one pressure screw, for type 2 - 4 housings, cable [mm] 9 - 13
1854035	VC-M-KV-PG21(11,5-15,5)	Half screw connection Pg21, made of metal, consisting of rubber seal with one hole and one pressure screw, for type 2 - 4 housings, cable [mm] 11.5 - 13.5

1854048	VC-M-KV-PG21(14-18)	Half screw connection Pg21, made of metal, consisting of rubber seal with one hole and one pressure screw, for type 2 - 4 housings, cable [mm] 14 - 18
1854051	VC-M-KV-PG21(17-20,5)	Half screw connection Pg21, made of metal, consisting of rubber seal with one hole and one pressure screw, for type 2 - 4 housings, cable [mm] 17 - 20.5
1885305	VC-M-KV-PG21(20X 7)	Single screw connection PG21, made of metal, consisting of rubber seal with a long hole and pressure screw, for type 2-4 housings, cable [mm] 20 x 7 mm (for flat-ribbon cable)
1854970	VC-M-KV-PG21- 1X8,5/1X12	Half screw connection Pg21, made of metal, consisting of rubber seal with several holes (1 x 8.5 mm/1 x 12 mm) and one pressure screw, for type 2 - 4 housings
Marking		
1852875	VC-BZS WH	Marker labels, unprinted, 5-section, for individual labeling with M-PEN or CMS system, white

Diagrams/Drawings

Dimensioned drawing

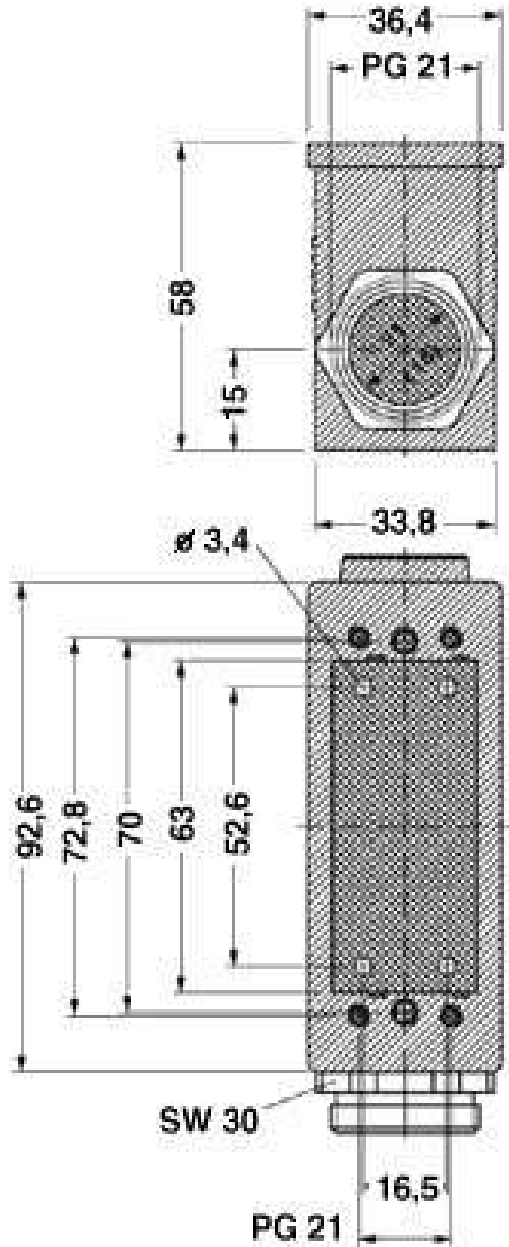

Address

PHOENIX CONTACT Deutschland GmbH
Flachmarktstr. 8
32825 Blomberg, Germany
Phone +49 5235 3 12000
Fax +49 5235 3 41200
<http://www.phoenixcontact.de>



© 2010 Phoenix Contact
Technical modifications reserved;